

cod.	C	L	
60401	016	32	25
60410	064	96	25
60415	096	128	25
60420	128	160	25
60425	160	192	10
60430	192	224	10
60435	224	256	10
60450	320	352	10
60480	512	544	10

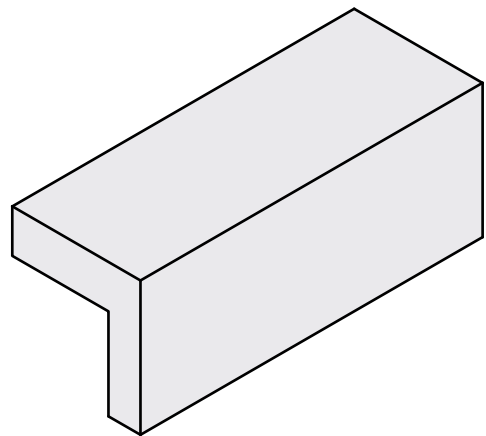

Aluminio. Tolerancias generales del plano: $\pm 0,5\text{mm}$.
Aluminium. General tolerances of technical drawing: $\pm 0,5\text{mm}$.
Aluminium. Tolérance générale du plan technique: $\pm 0,5\text{mm}$.

al-4