



**BRIALMA**

Maniglie  
in Alluminio  
Anodizzato

Anodized Aluminium Handles  
Manillas de Aluminio Anodizado  
Анодированные Алюминиевые Ручки

Since 1972 | 100% made in Italy





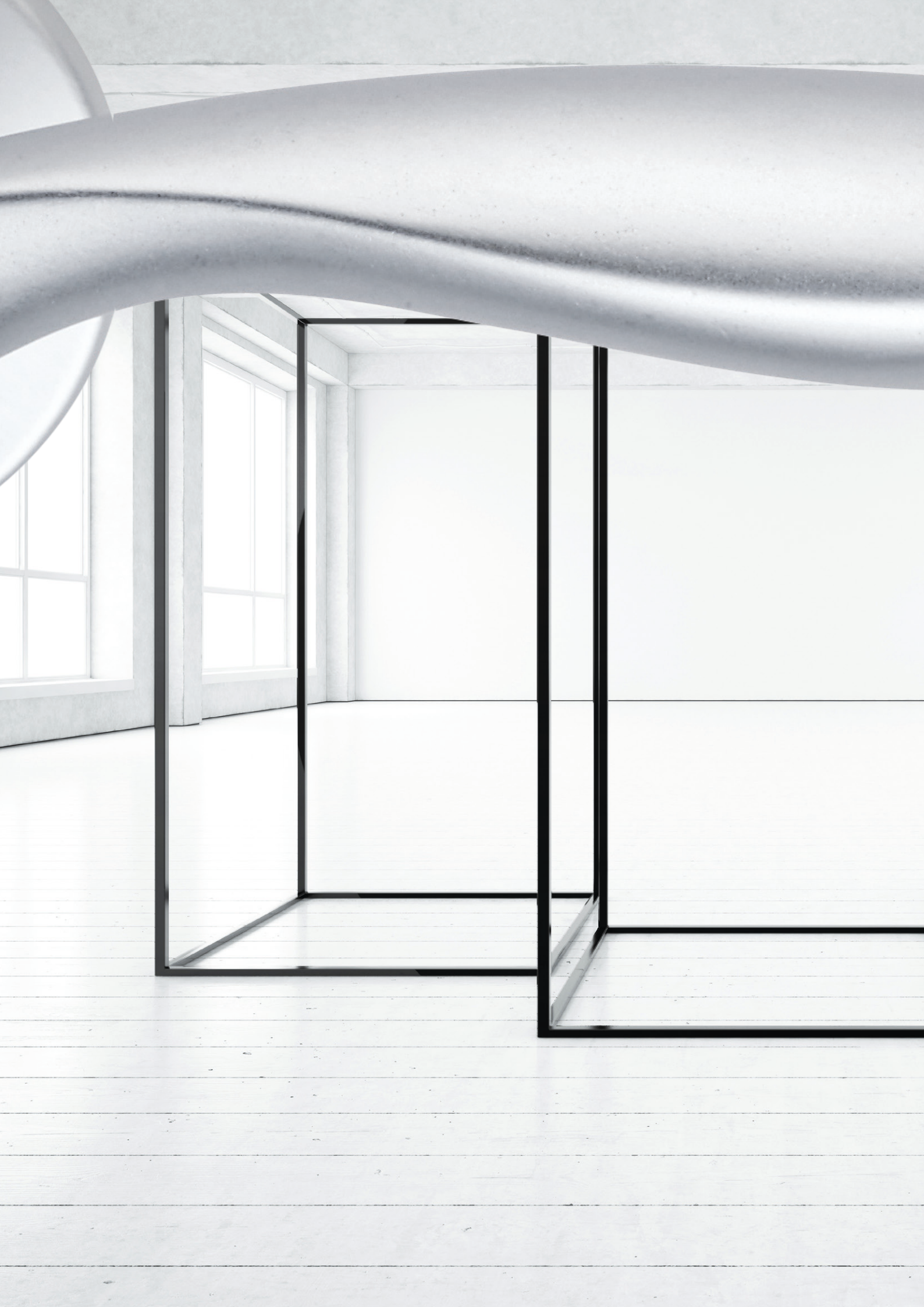



**BRIALMA**  
made in italy  
since 1972



## Design Italiano dal 1972

### **Italian Design since 1972**

Brialma was founded at the start of the 70's and has become one of the most solid manufacturing companies in the handle anodizing sector. Thanks to its concreteness and acquired dynamism, it offers excellent quality to the Italian and foreign markets. This quality is supported by experience and continually developing technology.

Brialma nasce all'inizio degli anni '70 e diventa una delle più solide aziende manifatturiere nel settore della maniglieria in alluminio anodizzato. Grazie alla concretezza e alla dinamicità acquisite, si propone sul mercato italiano ed estero con un'ottima qualità supportata da esperienza e tecnologia in continuo sviluppo.

### **Diseño italiano desde 1972**

BRIALMA nació a principios de los años 70 y se convirtió en una de las empresas más sólidas en el sector de la fabricación de manillas de aluminio anodizado. Gracias a la concreta gestión y el dinamismo adquirido, se propone en el mercado italiano y extranjero con una experiencia de alta calidad y tecnología con el apoyo de desarrollo continuo.

### **Итальянский дизайн начиная с 1972 года**

Фабрика Brialma была основано в начале 70-ых годов и стала одной из самых мощных производственных компаний, специализирующихся в секторе анодирования алюминиевых ручек. Благодаря своей конкретизации и приобретенному динамизму, она предлагает себя на итальянском и зарубежных рынках, с отличным качеством, которое поддерживается опытом и постоянно развивающимися технологиями.



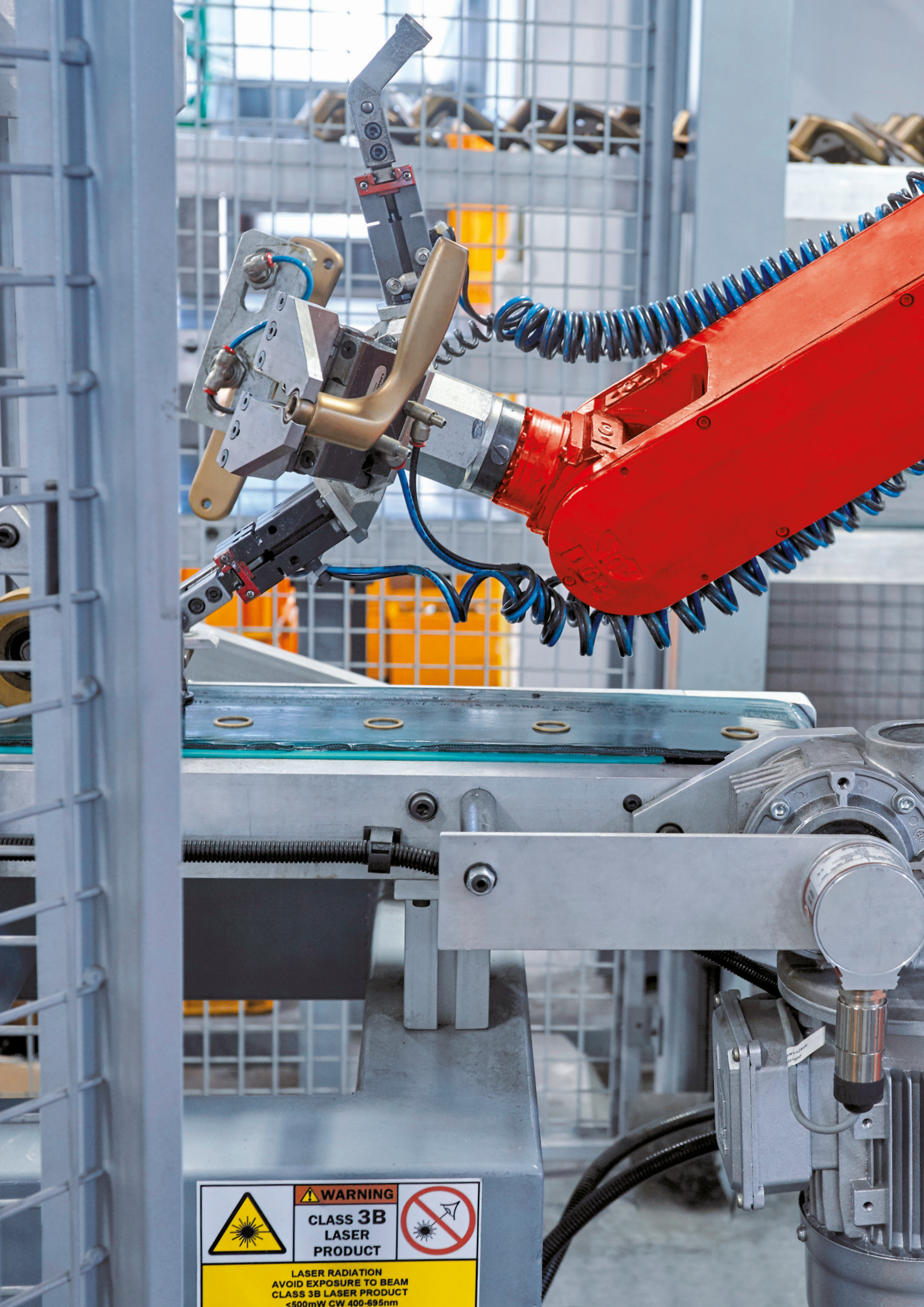

 **WARNING**  
**CLASS 3B**  
**LASER**  
**PRODUCT** 

LASER RADIATION  
AVOID EXPOSURE TO BEAM  
CLASS 3B LASER PRODUCT  
<500mW CW 400-695nm

**BRIALMA**  
made in italy  
since 1972



# Dalla materia prima al prodotto finito.

Tutto il ciclo produttivo è realizzato all'interno dell'azienda: dall'acquisto della materia prima alla vendita del prodotto finito. Brialma mette a disposizione una solida esperienza e una completa competenza anche per la realizzazione di prodotti personalizzati e/o progetti custom. Professionalità e serietà sono alla base del nostro lavoro e del nostro impegno quotidiano.



## Production

The entire production cycle is carried out within the company: from raw material to the sale of the finished product. BRIALMA provides extensive experience and expertise also for the realization of customized products and / or custom projects. Professionalism and reliability are the foundation of our work and our daily commitment.



Reparto produzione automatizzato  
Production department robot  
Departamento de producciòn automatizado  
Автоматизированное производство

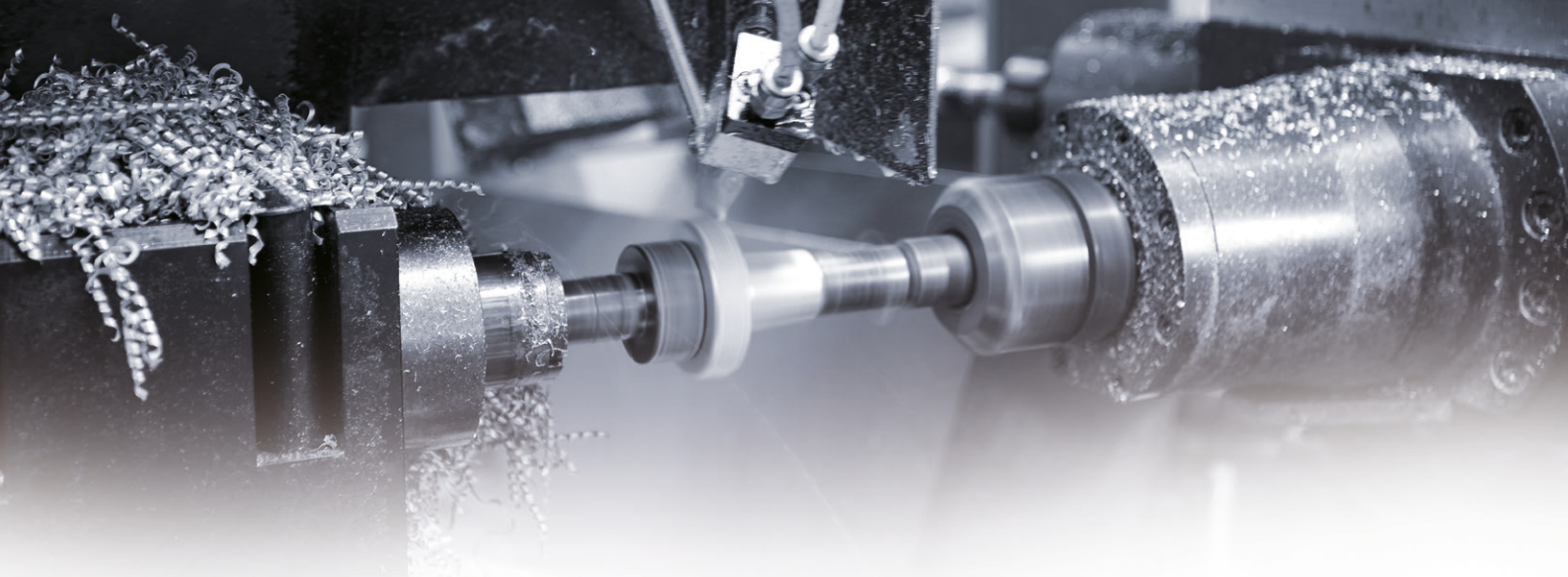

# Produzione

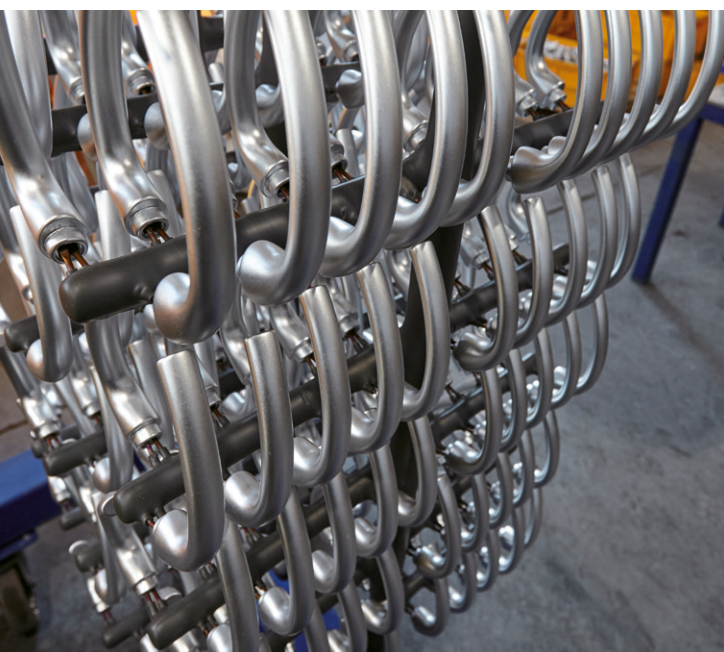

## **Producción**

Todo el ciclo productivo es realizado dentro de la empresa: de la adquisición de la materia primera a la venta del producto terminado. Brialma también pone a disposición una sólida experiencia y una completa competencia por la realización de productos personalizados y / o proyectos personalizados. Profesionalidad y seriedad son a la base de nuestro trabajo y nuestro empeño cotidiano.

## **продукция**

Весь производственный цикл осуществляется непосредственно компанией: начиная от сырья до продажи готового продукта. Также, благодаря многолетнему опыту и знаниям, BRIALMA обеспечивает возможность производств индивидуальных продуктов и / или проектов. Профессионализм и надежность являются основой нашей работы и наших повседневных обязательств.







**BRIALMA**  
made in italy  
since 1972



# Logistica



Magazzini interni  
Internal warehouses  
Almacenes internos  
Склады на территории фабрики



# Indice

Index | Índice | Индекс



Atlanta  
A29 pag. 18



Dublino  
D20 pag. 26



Jupiter  
J71 pag. 35



Seattle  
S44 pag. 43



Adelaide  
A57 pag. 19



Haiti  
H15 pag. 27



Saturn  
S77 pag. 36



Santiago  
S50 pag. 44



Acapulco  
A68 pag. 20



Kiev  
K81 pag. 28



Neptune  
N88 pag. 37



Milano  
M41 pag. 45



Bombay  
B63 pag. 21



Seattle  
S44 pag. 29



Quadra  
Q24 pag. 38



San Francisco  
S36 pag. 46



Manila  
M38 pag. 22



Texas  
T48 pag. 30



Rodi  
R84 pag. 39



Caracas  
C28 pag. 47



New York  
N23 pag. 23



Mars  
M33 pag. 32



Detroit  
D54 pag. 40



Glasgow  
G30 pag. 48



Astana  
A40 pag. 24



Mercury  
M46 pag. 33



Kiev  
K81 pag. 41



Kiruna  
K32 pag. 49



Nevada  
N34 pag. 25



Uranus  
U66 pag. 34



Lisbona  
L74 pag. 42



Texas  
T48 pag. 50



Kit per porte  
PVC e alluminio  
pag. 77



Maniglioni  
alzanti  
pag. 85 | 106



Maniglioni  
pag. 90



Pomoli  
pag. 109



DK  
pag. 121



Martelline e  
cremonesi  
pag. 139



Roma  
R19 pag. 51



Everest  
E06 pag. 59



Melbourne  
M12 pag. 67



Usa  
U04 pag. 75



Trio  
T03 pag. 52



Madrid  
M16 pag. 60



Japan XL  
J05 pag. 68



Corus  
C15 pag. 53



Dublino  
D20 pag. 61



Japan  
J05 pag. 69



Venus  
V21 pag. 54



Zagabria  
Z99 pag. 62



Sydney  
S02 pag. 70



Haiti  
H15 pag. 55



Bonn  
B25 pag. 63



Egitto  
E08 pag. 71



Londra  
L18 pag. 56



Toronto  
T10 pag. 64



Berlino  
B09 pag. 72



Atene  
A14 pag. 57



Sofia  
C11 pag. 65



Venezia  
V07 pag. 73



Firenze  
F22 pag. 58



Ginevra  
G01 pag. 66



Florida  
F13 pag. 74



Accessori per  
porte blindate  
pag. 145



Security  
Kit  
pag. 157



Accessori per porte  
scorrevoli  
pag. 165



Rosette e  
bocchette  
pag. 171



Placche  
pag. 182



Componenti  
pag. 186

# Finiture Disponibili

Finishing available

Acabados disponibles

Доступные покрытия

Finiture disponibili:	Finishes available:	Acabados disponibles:	Доступные покрытия:	
verniciatura cataforesi	gold painted by cataforesis	barnizado por cataforesis	катафорезное окрашивание	<b>OL</b>
argento	silver	plata	Серебро	<b>F1</b>
champagne	champagne	champán	Шампанское	<b>F2</b>
oro	gold	oro	Золото	<b>F3</b>
bronz	bronze	bronce	Бронза	<b>F4</b>
inox light	inox light	acero inoxidable claro	Светлая нержавеющая сталь	<b>F8</b>
inox	inox	inox inoxidables	Нержавеющая сталь	<b>F9</b>

Verniciatura:	Lacquering:	Barnizado:	Лакировка:	
verniciata bianca	white lacquer	blanco	белый	<b>B</b>
verniciata nera	black lacquer	negro	черный	<b>N</b>

argento satinato	satined silver	plata satinada	Матовое серебро	<b>F1S</b>
------------------	----------------	----------------	-----------------	------------

**Le finiture sopraelencate sono disponibili su ogni articolo.**

**The finishing listed above are available on all articles.**

**Todos los acabados están disponibles en todos los productos.**

**все перечисленные покрытия доступны по всем артикулам.**

## Maniglie Handles Manillas Ручки

A68	Acapulco	Pag.	20	R19	Roma	Pag.	51
A57	Adelaide	Pag.	19	S39	San Francisco	Pag.	46
A40	Astana	Pag.	24	S50	Santiago	Pag.	44
A14	Atene	Pag.	57	S77	Saturn	Pag.	36
A29	Atlanta	Pag.	18	S44	Seattle	Pag.	29/43
B09	Berlino	Pag.	72	C11	Sofia	Pag.	65
B63	Bombay	Pag.	21	S02	Sydney	Pag.	70
B25	Bonn	Pag.	63	T48	Texas	Pag.	30/50
C28	Caracas	Pag.	47	T10	Toronto	Pag.	64
C15	Corus	Pag.	53	T03	Trio	Pag.	52
D54	Detroit	Pag.	40	U66	Uranus	Pag.	34
D20	Dublino	Pag.	26/61	U04	Usa	Pag.	75
E08	Egitto	Pag.	71	V07	Venezia	Pag.	73
E06	Everest	Pag.	59	V21	Venus	Pag.	54
F22	Firenze	Pag.	58	Z99	Zagabria	Pag.	62
F13	Florida	Pag.	574	<b>Kit Porte Pvc e Alluminio</b>		Pag.	77
G01	Ginevra	Pag.	66	Set For Pvc & Aluminium Door			
G30	Glasgow	Pag.	48	Kit para puertas PVC y Aluminio			
H15	Haiti	Pag.	27/55	Комплект для ПВХ и Алюминия			
J05	Japan	Pag.	69	<b>Maniglioni Pull Handles Manillones Ручки скобы</b>			
J05XL	Japan XL	Pag.	68	19000		Pag.	86
J71	Jupiter	Pag.	35	18050		Pag.	87
K81	Kiev	Pag.	28/41	18000		Pag.	88
K32	Kiruna	Pag.	49	17000		Pag.	89
L74	Lisbona	Pag.	42	6200		Pag.	90
L18	Londra	Pag.	56	6210		Pag.	91
M16	Madrid	Pag.	60	6220		Pag.	92
M38	Manila	Pag.	22	6500		Pag.	93
M33	Mars	Pag.	32	6510		Pag.	94
M12	Melbourne	Pag.	67	6515		Pag.	95
M46	Mercury	Pag.	33	6400		Pag.	96
M41	Milano	Pag.	45	6410		Pag.	97
N88	Neptune	Pag.	88	6415		Pag.	98
N34	Nevada	Pag.	25	6300		Pag.	99
N23	New York	Pag.	23	6310		Pag.	100
Q24	Quadra	Pag.	38	6315		Pag.	101
R84	Rodi	Pag.	39				

# Indice

Index  
Índice  
Индекс

**BRIALMA**  
made in italy  
since 1972



6001	Pag.	102
6003	Pag.	103
6005	Pag.	104
6007	Pag.	105
6000 - 6020 - 6050	Pag.	106
6030 - 6010	Pag.	107

## **Pomoli** Knobs Pomos Кнобы

PBC60	Pag.	113/117
PBR60	Pag.	111
PCR54	Pag.	110
PG10	Pag.	116
PLI64	Pag.	31/110
PMA44	Pag.	112
PMA50	Pag.	112
PMA56	Pag.	112
PMA70	Pag.	114
PMG99	Pag.	110
PMI45	Pag.	116
PMI4583	Pag.	115
PSQ55	Pag.	114
PSS61	Pag.	111
PT050	Pag.	114
PTR60	Pag.	113/117
PUN55	Pag.	113
PUN5567	Pag.	115
PUN5568	Pag.	115
PUN70	Pag.	111
PEL35	Pag.	118

## **DK** Window Handles Para ventanas Ручки серии

A2970M	Atlanta	Pag.	122
A57DX70M	Adelaide	Pag.	122
A6870M	Acapulco	Pag.	122
B6370M	Bombay	Pag.	123
M3870M	Manila	Pag.	123
N2370M	New York	Pag.	123
A4070	Astana	Pag.	124
N3470	Nevada	Pag.	124
D2070	Dublino	Pag.	124
H1570	Haiti	Pag.	125
K8170	Kiev	Pag.	125
S4470	Seattle	Pag.	125
T4870	Texas	Pag.	126
M3370M	Mars	Pag.	126
M4670M	Mercury	Pag.	126
U6670DXM	Uranus	Pag.	127
J7170M	Jupiter	Pag.	127
S7770M	Saturn	Pag.	127
N8870M	Neptune	Pag.	128
Q2470M	Quadra	Pag.	128
D54DX70	Detroit	Pag.	128
L4770	Lisbona	Pag.	129
S5070	Santiago	Pag.	129
M41DX70	Milano	Pag.	129
G3070	Glasgow	Pag.	130
K3270	Kiruna	Pag.	130
R1970	Roma	Pag.	130
T0370	Trio	Pag.	131
C1570	Corus	Pag.	131
V2170	Venus	Pag.	131
L1870	Londra	Pag.	132

A1470	Atene	Pag.	132
F2270	Firenze	Pag.	132
M1670	Madrid	Pag.	133
EU0670	Everest	Pag.	133
Z99DX70	Zagabria	Pag.	133
B2570	Bonn	Pag.	134
T1070	Toronto	Pag.	134
C11DX70	Sofia	Pag.	134
GB0170	Ginevra	Pag.	135
M1270	Melbourne	Pag.	135
J0570	Japan	Pag.	135
SS0270	Sydney	Pag.	136
VN0770	Venezia	Pag.	136
F1370	Florida	Pag.	136
UN0470	Usa	Pag.	137

## **Cremonesi e Martelline**

Window Handles Para ventanas Ручки серии

MT1140	Pag.	140
MT1120	Pag.	140
MT1130	Pag.	140
MTS1130	Pag.	141
MTM1120	Pag.	141
MTJ1140	Pag.	141

## **Tabella per Creazione Codici** | Code's Explanation

Tabla para la creacion de codigos | Таблица формирования кодов

## **Accessori per Porte Blindate** Pag. 145

Armoured Door Accessories  
Accesorios para puertas acorazadas  
Аксессуары для дверей

## **Kit Sicurezza** Pag. 157

Security Kit Security Kit Комплект безопасности

## **Kit Hotel** Pag. 163

Kit Hotel Kit Hotel комплектHotel

## **Accessori Porte Scorrevoli** Pag. 165

Accessories For Sliding Doors  
Accesorios para puertas correderas  
Аксессуары для раздвижных дверей

## **Rosette e Bocchette** Pag. 171

Roses And Escutcheons  
Rosetas y bocallaves  
Розетки и накладки

## **Placche** Plates Placas Планки Pag. 182

## **Parti Metalliche** Pag. 186

Components  
Componentes metálicos  
комплектующие из металла

## **Condizioni Generali di Vendita** Pag. 190

General Terms And Sales Conditions  
Condiciones generales de venta  
Общие условия продаж





Italian Design Since 1972

**BRIALMA**  
made in italy  
since 1972



Maniglie  
Handles  
Manillas  
Ручки

A29

# Atlanta

A291171Y

- IT** Guarnitura maniglia con rosette e bocchette Ø 55 foro Yale
- EN** Lever handle with roses and escutcheons Ø 55 PZ hole
- ES** Juego de manijas con rosetas y bocallaves Ø 55
- RU** Нажимная ручка с розетками и накладками Ø 55 с отверстием для цилиндра



▶ Pag. 122

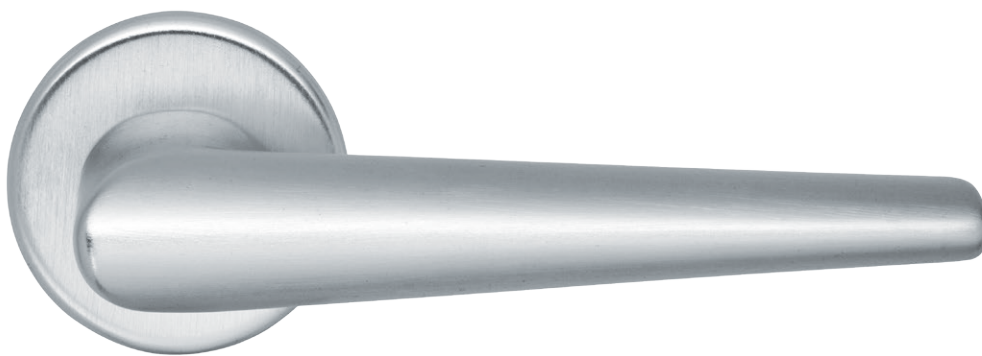

## Technical Informations

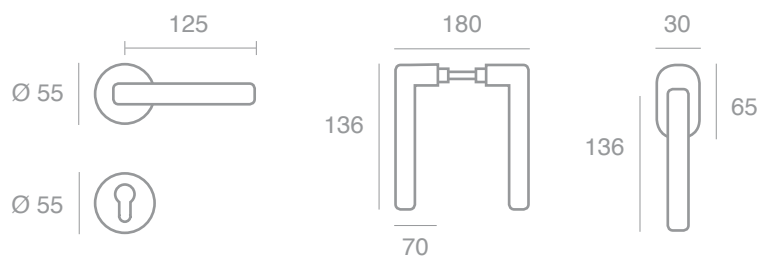

A57

# Adelaide

A571171Y

- IT** Guarnitura maniglia con rosette e bocchette Ø 55 foro Yale
- EN** Lever handle with roses and escutcheons Ø 55 PZ hole
- ES** Juego de manijas con rosetas y bocallaves Ø 55
- RU** Нажимная ручка с розетками и накладками Ø 55 с отверстием для цилиндра

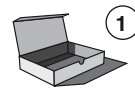

► Pag. 122

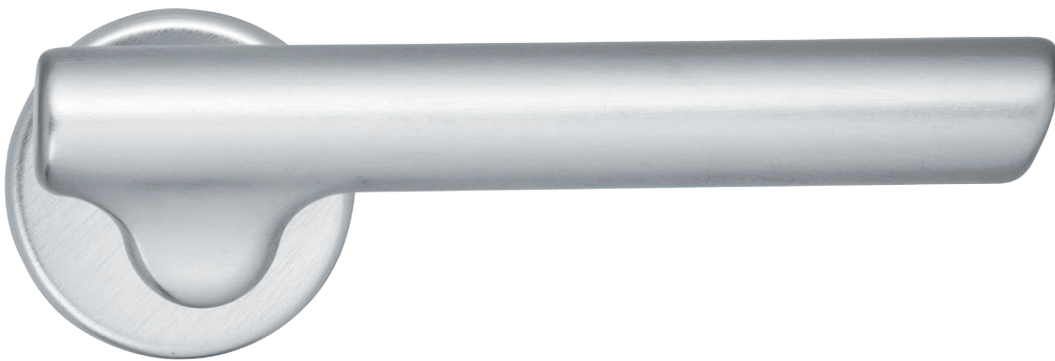

## Technical Informations

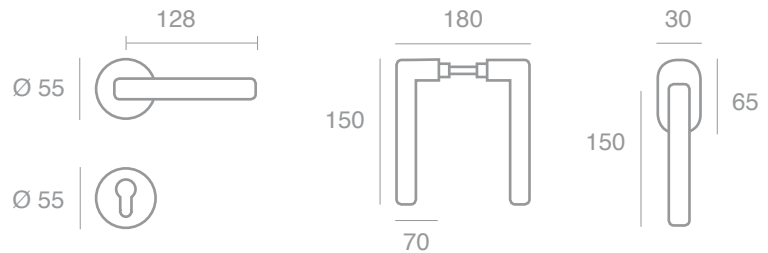

A68

# Acapulco

A688797Y

- IT** Guarnitura maniglia con rosette e bocchette quadre foro Yale
- EN** Lever handle with square roses and escutcheons PZ hole
- ES** Juego de manijas con rosetas y bocallaves cuadradas, Yale
- RU** Нажимная ручка с квадратными розетками и накладками с отверстием для цилиндра



► Pag. 122

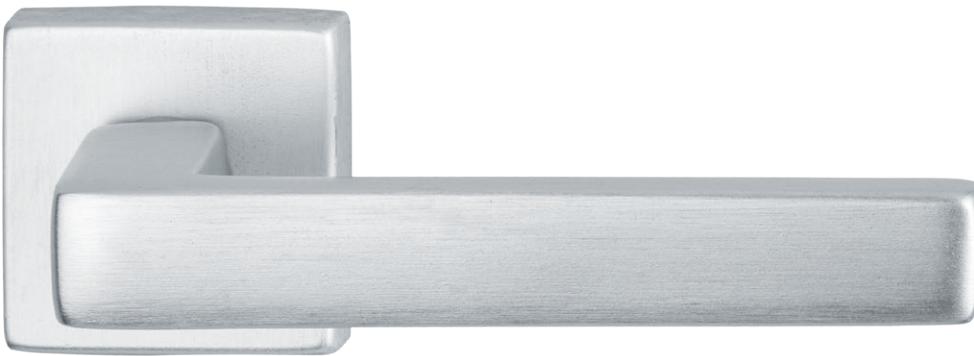

## Technical Informations

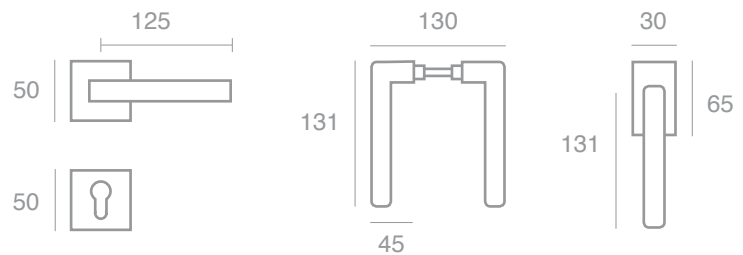

B63

# Bombay

B631171Y

- IT** Guarnitura maniglia con rosette e bocchette Ø 55 foro Yale
- EN** Lever handle with roses and escutcheons Ø 55 PZ hole
- ES** Juego de manijas con rosetas y bocallaves Ø 55
- RU** Нажимная ручка с розетками и накладками Ø 55 с отверстием для цилиндра



► Pag. 123



## Technical Informations

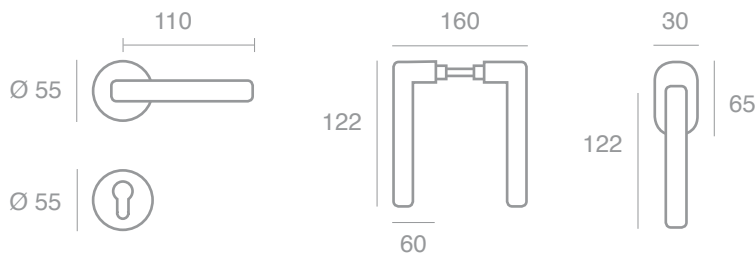

M38

# Manila

M381171Y

- IT** Guarnitura maniglia con rosette e bocchette Ø 55 foro Yale
- EN** Lever handle with roses and escutcheons Ø 55 PZ hole
- ES** Juego de manijas con rosetas y bocallaves Ø 55 Yale
- RU** Нажимная ручка с розетками и накладками Ø 55 с отверстием для цилиндра



▶ Pag. 123



### Technical Informations

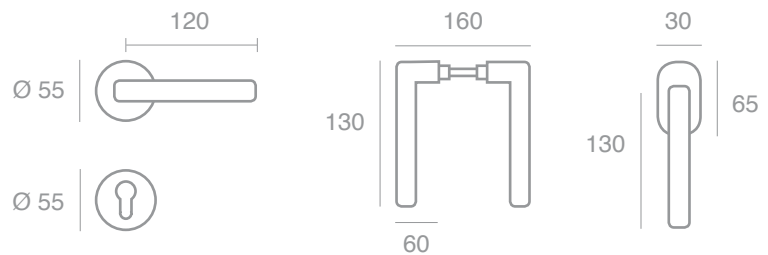

N23

# New York

N231171Y

- IT** Guarnitura maniglia con rosette e bocchette Ø 55 foro Yale
- EN** Lever handle with roses and escutcheons Ø 55 PZ hole
- ES** Juego de manijas con rosetas y bocallaves Ø 55 Yale
- RU** Нажимная ручка с розетками и накладками Ø 55 с отверстием для цилиндра



► Pag. 123

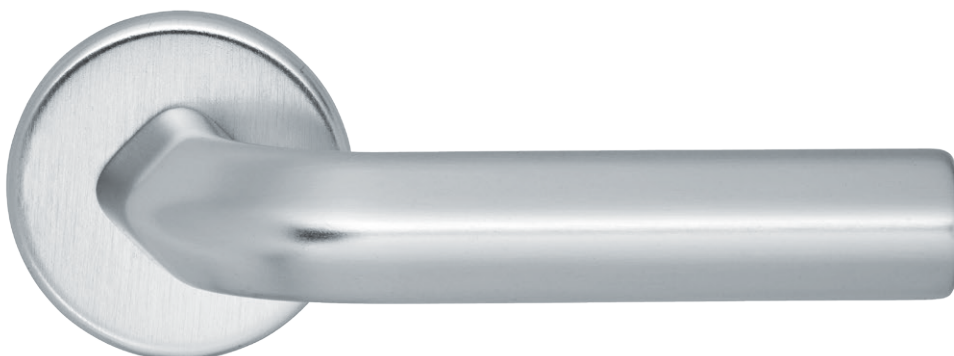

## Technical Informations

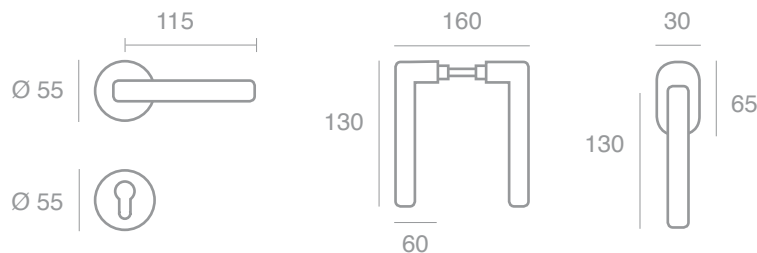

A40

# Astana

A408194P

- IT** Guarnitura maniglia con rosette e bocchette Ø 50 foro chiave
- EN** Lever handle with roses and escutcheons Ø 50 key hole
- ES** Juego de manijas con rosetas y bocallaves Ø 50, bocallaves gorjas
- RU** Пара ручек на розетке с накладкой Ø 50 с отверстием под кабинетный ключ



▶ Pag. 124



## Technical Informations

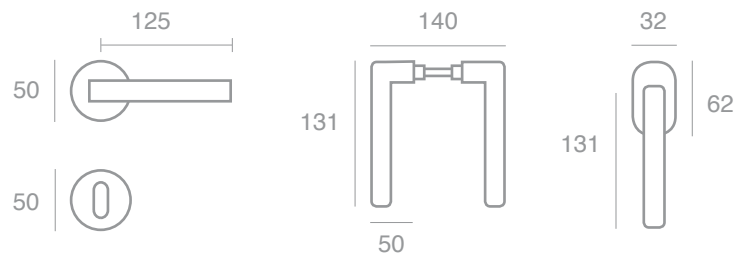



N34

# Nevada

N348194P

- IT** Guarnitura maniglia con rosette e bocchette Ø 50 foro chiave
- EN** Lever handle with roses and escutcheons Ø 50 key hole
- ES** Juego de manijas con rosetas y bocallaves Ø 50, bocallaves gorjas
- RU** Пара ручек на розетке с накладкой Ø 50 с отверстием под кабинетный ключ



► Pag. 124



## Technical Informations

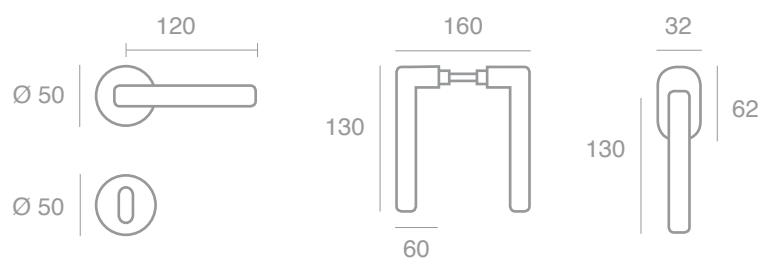



H15

# Haiti

H158194YOL

- IT** Guarnitura maniglia con rosette e bocchette Ø 50 foro Yale
- EN** Lever handle with roses and escutcheons Ø 50 PZ hole
- ES** Juego de manijas con rosetas y bocallaves Ø 50 Yale
- RU** Нажимная ручка с розетками и накладками Ø 50 с отверстием для цилиндра



► Pag. 125



### Technical Informations

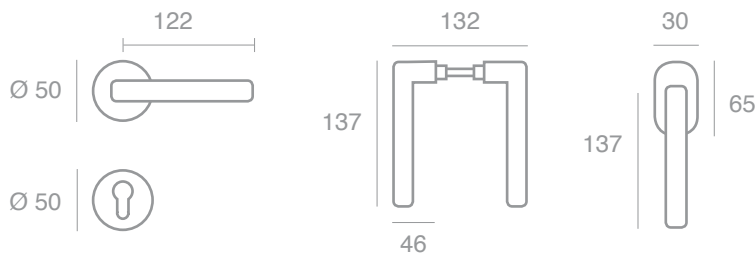

K81

# Kiev

K818194YOL

- IT** Guarnitura maniglia con rosette e bocchette Ø 50 foro Yale
- EN** Lever handle with roses and escutcheons Ø 50 PZ hole
- ES** Juego de manijas con rosetas y bocallaves Ø 50 Yale
- RU** Нажимная ручка с розетками и накладками Ø 50 с отверстием для цилиндра



▶ Pag. 125



### Technical Informations

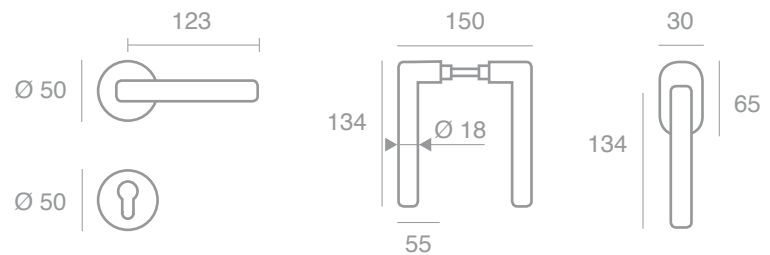

S44

# Seattle

S448194YOL

- IT** Guarnitura maniglia con rosette e bocchette Ø 50 foro Yale
- EN** Lever handle with roses and escutcheons Ø 50 PZ hole
- ES** Juego de manijas con rosetas y bocallaves Ø 50 Yale
- RU** Нажимная ручка с розетками и накладками Ø 50 с отверстием для цилиндра



► Pag. 125



## Technical Informations

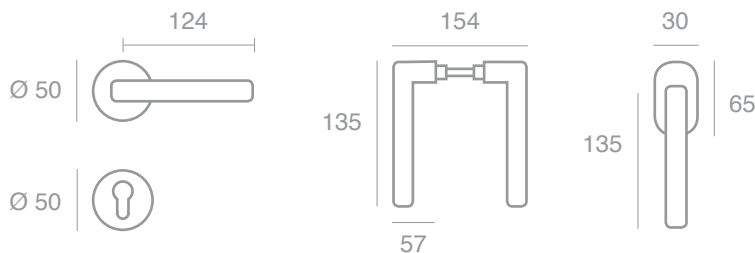

T48

# Texas

T488194YOL

- IT** Guarnitura maniglia con rosette e bocchette Ø 50 foro Yale
- EN** Lever handle with roses and escutcheons Ø 50 PZ hole
- ES** Juego de manijas con rosetas y bocallaves Ø 50 Yale
- RU** Нажимная ручка с розетками и накладками Ø 50 с отверстием для цилиндра



▶ Pag. 126



### Technical Informations

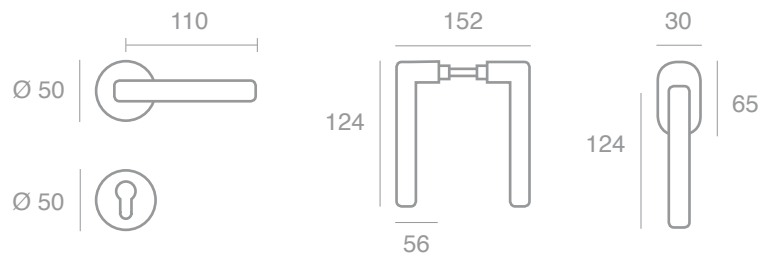

## PLI64



PLI6460OL

- IT** Pomolo con rosetta Ø 50
- EN** Knob with rose Ø 50
- ES** Pomo con roseta Ø 50
- RU** Кноб на розетке Ø 50



### Technical Informations

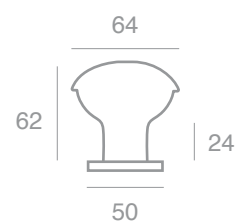

## 4000TM



4000TMOL

- IT** Nottolino WC su rosetta Ø 50 con taglio-moneta in metallo
- EN** WC set on rose Ø 50 with metallic pin
- ES** Condena por WC con desbloqueo en metal y roseta Ø 50
- RU** Комплект розеток для санузла Ø 50 с пластиковым штифтома



### Technical Informations

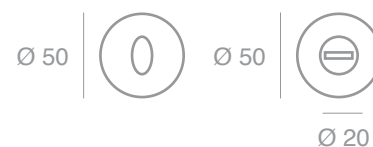

M33

# Mars

M338797Y

- IT** Guarnitura maniglia con rosette e bocchette quadre foro Yale
- EN** Lever handle with square roses and escutcheons PZ hole
- ES** Juego de manijas con rosetas y bocallaves cuadradas, Yale
- RU** Нажимная ручка с квадратными розетками и накладками розетками и накладками с отверстием для цилиндра



**Finitura disponibile**  
**F1 satinato**  
 Available finishing  
 satined F1



▶ Pag. 126



### Technical Informations

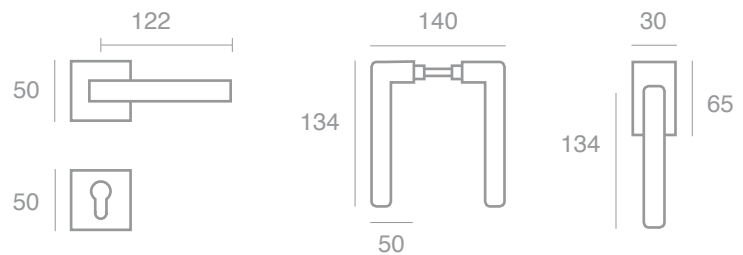



M46

# Mercury

M468797Y

- IT** Guarnitura maniglia con rosette e bocchette quadre foro Yale
- EN** Lever handle with square roses and escutcheons PZ hole
- ES** Juego de manijas con rosetas y bocallaves cuadradas, Yale
- RU** Нажимная ручка с квадратными розетками и накладками с отверстием для цилиндра



**Finitura disponibile**  
**F1 satinato**

Available finishing  
satinated F1



▶ Pag. 126



## Technical Informations

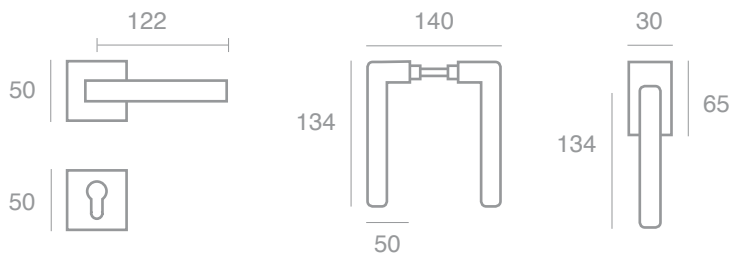

U66

# Uranus

U668797Y

- IT** Guarnitura maniglia con rosette e bocchette quadre foro Yale
- EN** Lever handle with square roses and escutcheons PZ hole
- ES** Juego de manijas con rosetas y bocallaves cuadradas, Yale
- RU** Нажимная ручка с квадратными розетками и накладками розетками и накладками с отверстием для цилиндра



**Finitura disponibile**  
**F1 satinato**  
 Available finishing  
 satined F1



▶ Pag. 127



## Technical Informations

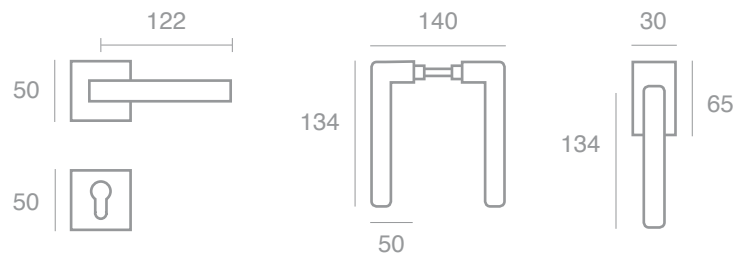

J71

# Jupiter

J718797Y

- IT** Guarnitura maniglia con rosette e bocchette quadre foro Yale
- EN** Lever handle with square roses and escutcheons PZ hole
- ES** Juego de manijas con rosetas y bocallaves cuadradas, Yale
- RU** Нажимная ручка с квадратными розетками и накладками с отверстием для цилиндра



**Finitura disponibile**  
**F1 satinato**

Available finishing  
satinated F1



▶ Pag. 127



## Technical Informations

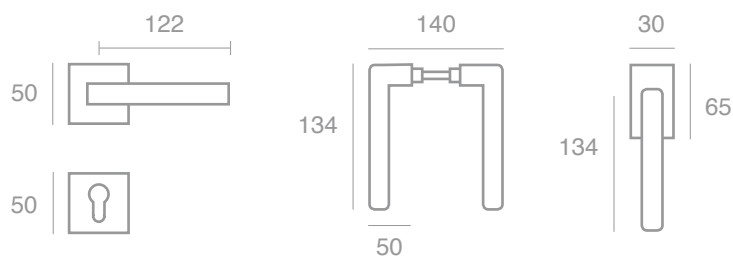

S77

# Saturn

S778595Y

- IT** Guarnitura maniglia con rosette e bocchette Ø 52 foro Yale
- EN** Lever handle with roses and escutcheons Ø 52 PZ hole
- ES** Juego de manijas con rosetas y bocallaves Ø 52 Yale
- RU** Нажимная ручка с розетками и накладками Ø 52 с отверстием для цилиндра



**Finitura disponibile**  
**F1 satinato**  
 Available finishing  
 satined F1



► Pag. 127



## Technical Informations

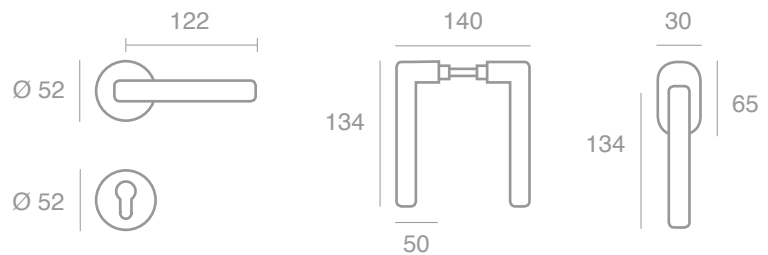

N88

# Neptune

N888595Y

- IT** Guarnitura maniglia con rosette e bocchette Ø 52 foro Yale
- EN** Lever handle with roses and escutcheons Ø 52 PZ hole
- ES** Juego de manijas con rosetas y bocallaves Ø 52 Yale
- RU** Нажимная ручка с розетками и накладками Ø 52 с отверстием для цилиндра



**Finitura disponibile**  
**F1 satinato**  
Available finishing  
satinated F1



▶ Pag. 128



### Technical Informations

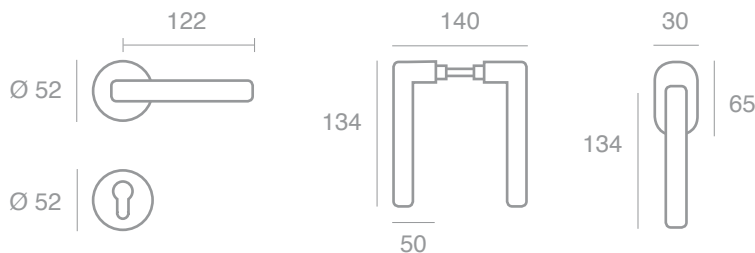

Q24

# Quadra

Q248797Y

- IT** Guarnitura maniglia con rosette e bocchette quadre foro Yale
- EN** Lever handle with square roses and escutcheons PZ hole
- ES** Juego de manijas con rosetas y bocallaves cuadradas, Yale
- RU** Нажимная ручка с квадратными розетками и накладками с отверстием для цилиндра



► Pag. 128



## Technical Informations

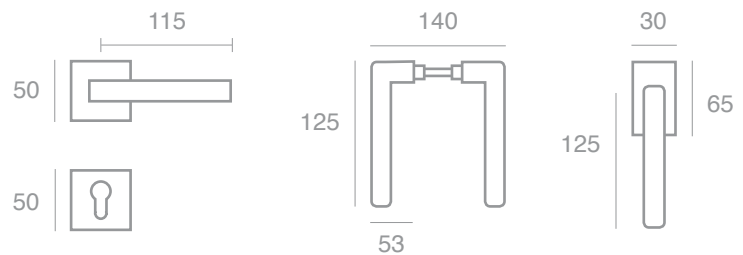

R84

# Rodi

R848595B

- IT** Guarnitura maniglia con rosette e bocchette Ø 52 foro BB
- EN** Lever handle with roses and escutcheons Ø 52 BB hole
- ES** Juego de manijas con rosetas y bocallaves Ø 52 gorjas BB
- RU** Нажимная ручка с розетками и накладками Ø 52 с отверстием для межкомнатного ключа



### Technical Informations

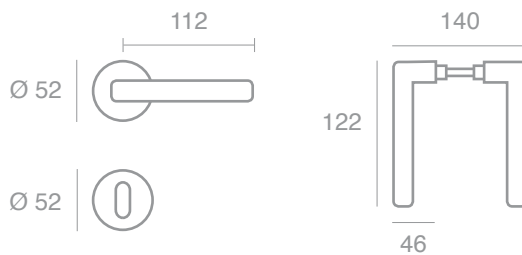

D54

# Detroit

D548194Y

- IT** Guarnitura maniglia con rosette e bocchette Ø 50 foro Yale
- EN** Lever handle with roses and escutcheons Ø 50 PZ hole
- ES** Juego de manijas con rosetas y bocallaves Ø 50 Yale
- RU** Нажимная ручка с розетками и накладками Ø 50 с отверстием для цилиндра



▶ Pag. 128

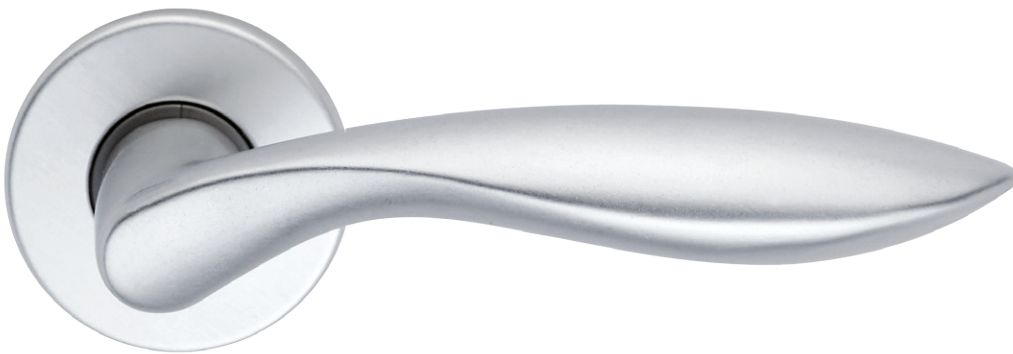

### Technical Informations

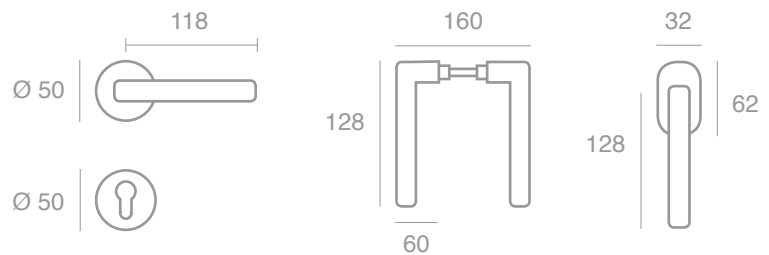



K81

# Kiev

K818194Y

- IT** Guarnitura maniglia con rosette e bocchette Ø 50 foro Yale
- EN** Lever handle with roses and escutcheons Ø 50 PZ hole
- ES** Juego de manijas con rosetas y bocallaves Ø 50 Yale
- RU** Нажимная ручка с розетками и накладками Ø 50 с отверстием для цилиндра



► Pag. 125

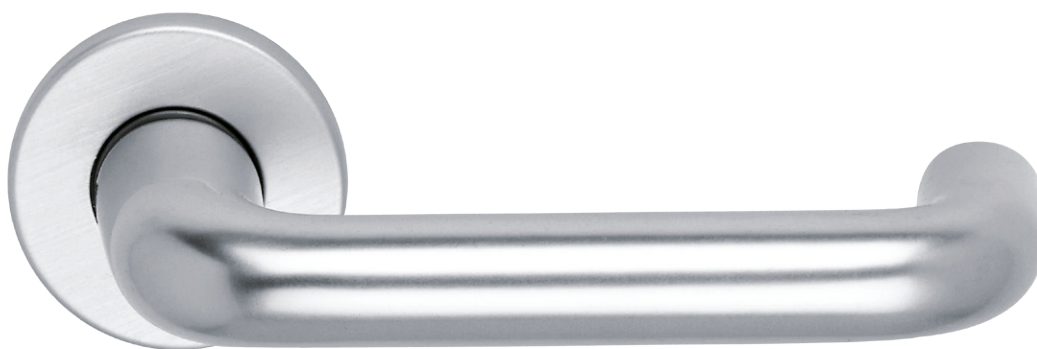

### Technical Informations

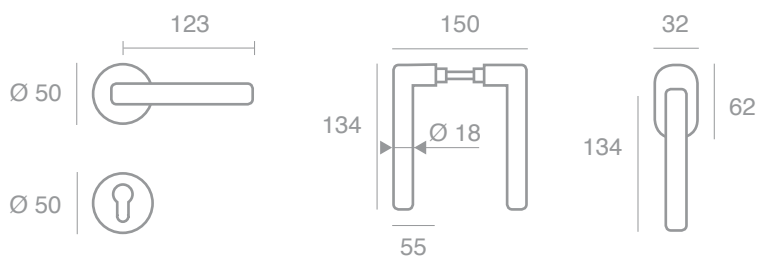

L74

# Lisbona

L748194Y

- IT** Guarnitura maniglia con rosette e bocchette Ø 50 foro Yale
- EN** Lever handle with roses and escutcheons Ø 50 PZ hole
- ES** Juego de manijas con rosetas y bocallaves Ø 50 Yale
- RU** Нажимная ручка с розетками и накладками Ø 50 с отверстием для цилиндра



▶ Pag. 129

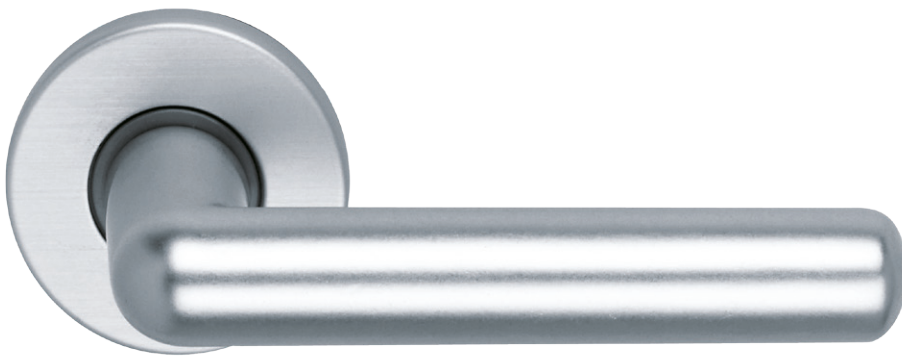

## Technical Informations

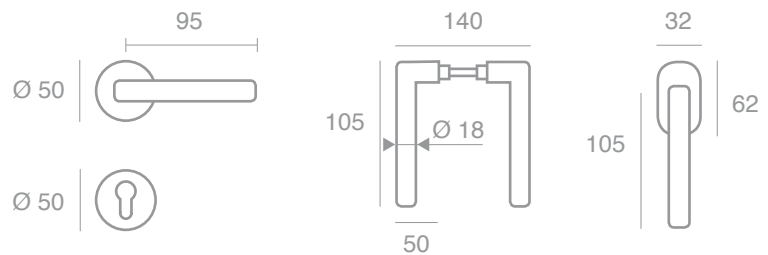

S44

# Seattle

S448194P

- IT** Guarnitura maniglia con rosette e bocchette Ø 50 foro chiave
- EN** Lever handle with roses and escutcheons Ø 50 key hole
- ES** Juego de manijas con rosetas y bocallaves Ø 50, bocallaves gorjas
- RU** Пара ручек на розетке с накладкой Ø 50 с отверстием под кабинетный ключ



► Pag. 125



### Technical Informations

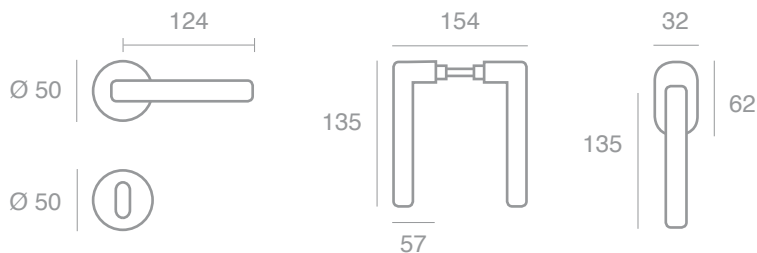

S50

# Santiago

S508194P

- IT** Guarnitura maniglia con rosette e bocchette Ø 50 foro chiave
- EN** Lever handle with roses and escutcheons Ø 50 key hole
- ES** Juego de manijas con rosetas y bocallaves Ø 50, bocallaves gorjas
- RU** Пара ручек на розетке с накладкой Ø 50 с отверстием под кабинетный ключ



▶ Pag. 129

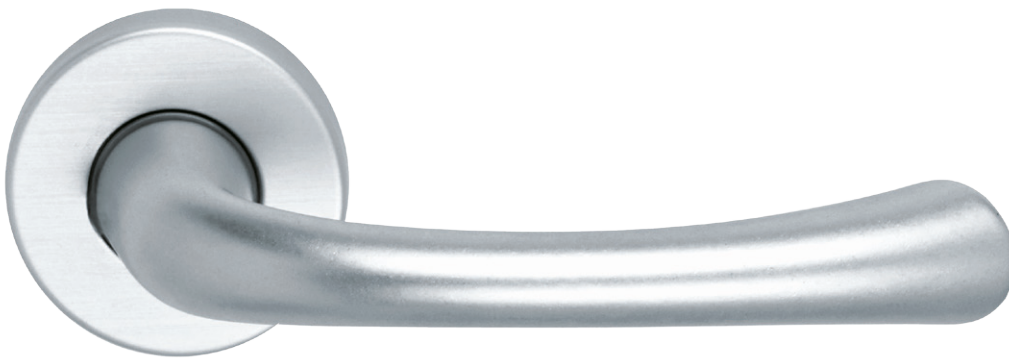

### Technical Informations

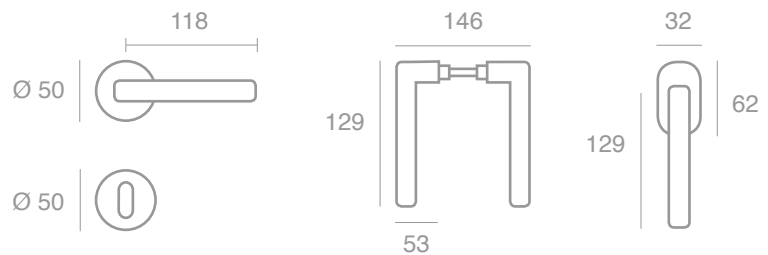

M41

# Milano

M418194Y

- IT** Guarnitura maniglia con rosette e bocchette Ø 50 foro Yale
- EN** Lever handle with roses and escutcheons Ø 50 PZ hole
- ES** Juego de manijas con rosetas y bocallaves Ø 50 Yale
- RU** Нажимная ручка с розетками и накладками Ø 50 с отверстием для цилиндра



► Pag. 129



## Technical Informations

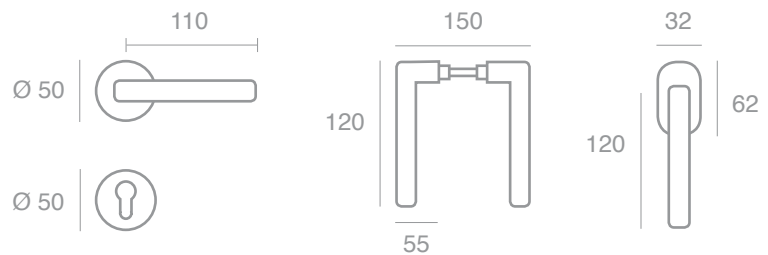

S36

# San Francisco

S368194Y

- IT** Guarnitura maniglia con rosette e bocchette Ø 50 foro Yale
- EN** Lever handle with roses and escutcheons Ø 50 PZ hole
- ES** Juego de manijas con rosetas y bocallaves Ø 50
- RU** Нажимная ручка с розетками и накладками Ø 50 с отверстием для цилиндра

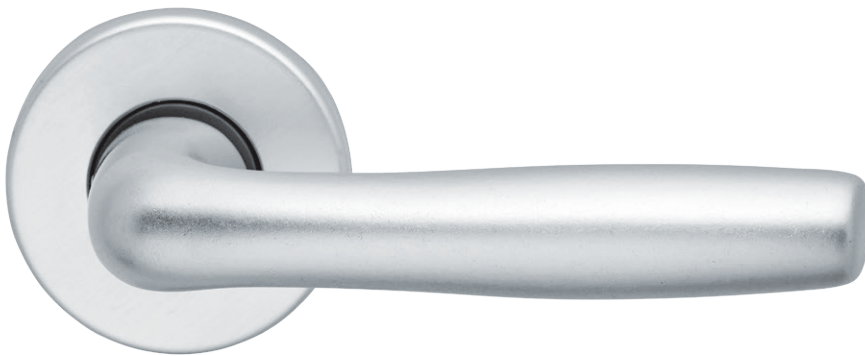

## Technical Informations

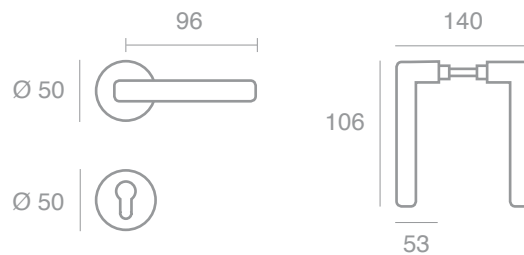

C28

# Caracas

C288595Y

- IT** Guarnitura maniglia con rosette e bocchette Ø 52 foro Yale
- EN** Lever handle with roses and escutcheons Ø 52 PZ hole
- ES** Juego de manijas con rosetas y bocallaves Ø 52
- RU** Нажимная ручка с розетками и накладками Ø 52 с отверстием для цилиндра



## Technical Informations

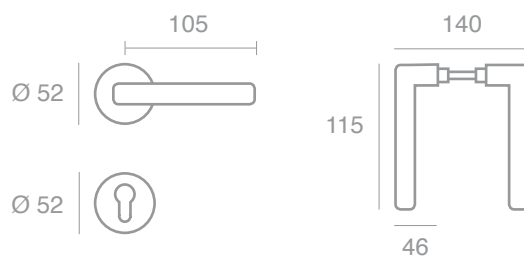

G30

# Glasgow

G308194P

- IT** Guarnitura maniglia con rosette e bocchette Ø 50 foro chiave
- EN** Lever handle with roses and escutcheons Ø 50 key hole
- ES** Juego de manijas con rosetas y bocallaves Ø 50, bocallaves gorjas
- RU** Пара ручек на розетке с накладкой Ø 50 с отверстием под кабинетный ключ



▶ Pag. 130



## Technical Informations

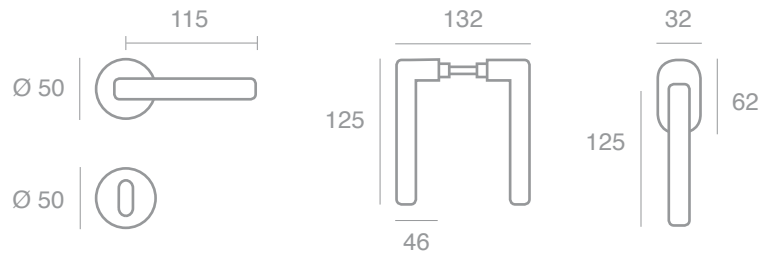



K32

# Kiruna

K328194Y

- IT** Guarnitura maniglia con rosette e bocchette Ø 50 foro Yale
- EN** Lever handle with roses and escutcheons Ø 50 PZ hole
- ES** Juego de manijas con rosetas y bocallaves Ø 50 Yale
- RU** Нажимная ручка с розетками и накладками Ø 50 с отверстием для цилиндра



► Pag. 130

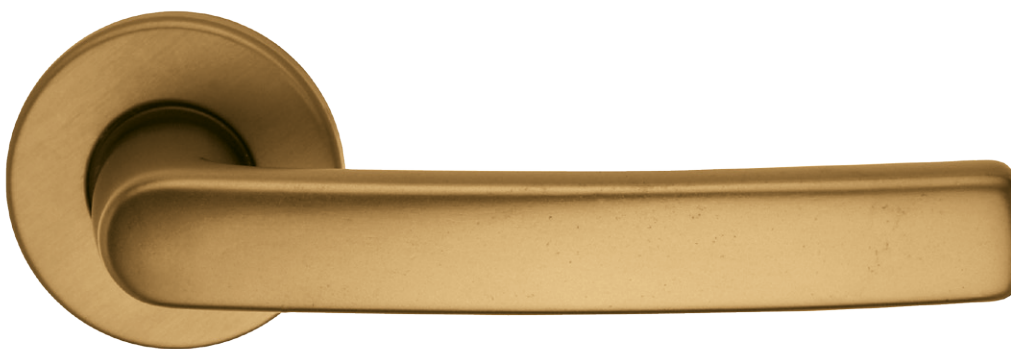

## Technical Informations

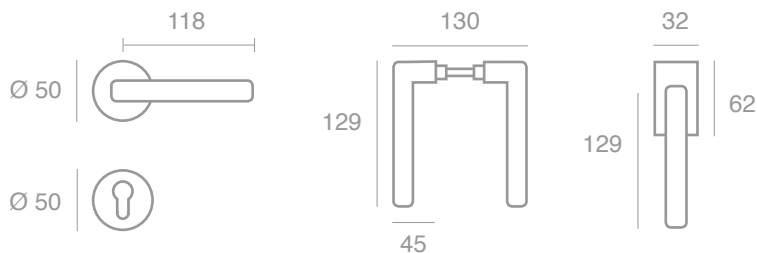

T48

# Texas

T488194Y

- IT** Guarnitura maniglia con rosette e bocchette Ø 50 foro Yale
- EN** Lever handle with roses and escutcheons Ø 50 PZ hole
- ES** Juego de manijas con rosetas y bocallaves Ø 50 Yale
- RU** Нажимная ручка с розетками и накладками Ø 50 с отверстием для цилиндра



▶ Pag. 126



### Technical Informations

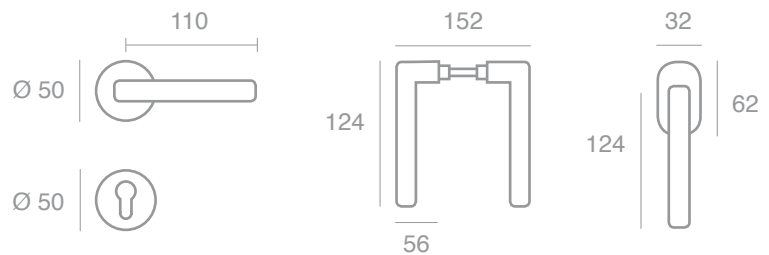

R19

# Roma

R198194B

- IT** Guarnitura maniglia con rosette e bocchette Ø 50 foro BB
- EN** Lever handle with roses and escutcheons Ø 50 BB hole
- ES** Juego de manijas con rosetas y bocallaves Ø 50 gorjas BB
- RU** Нажимная ручка с розетками и накладками Ø 50 с отверстием для межкомнатного ключа



► Pag. 130



### Technical Informations

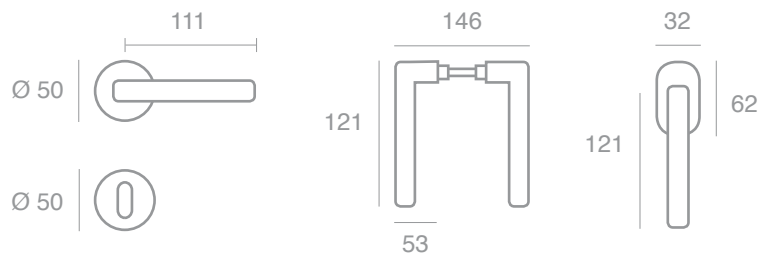

T03

# Trio

T038194B

- IT** Guarnitura maniglia con rosette e bocchette Ø 50 foro BB
- EN** Lever handle with roses and escutcheons Ø 50 BB hole
- ES** Juego de manijas con rosetas y bocallaves Ø 50 gorjas BB
- RU** Нажимная ручка с розетками и накладками Ø 50 с отверстием для межкомнатного ключа

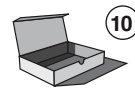

▶ Pag. 131



## Technical Informations

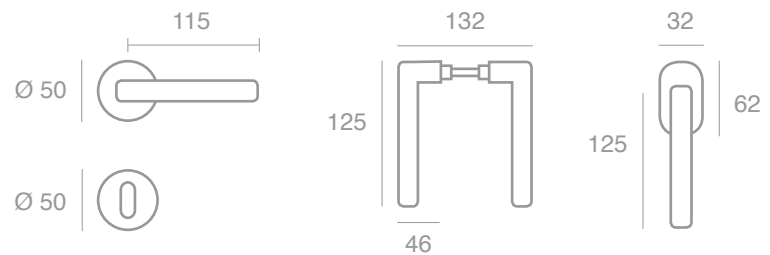

C15

# Corus

C158194B

- IT** Guarnitura maniglia con rosette e bocchette Ø 50 foro BB
- EN** Lever handle with roses and escutcheons Ø 50 BB hole
- ES** Juego de manijas con rosetas y bocallaves Ø 50 gorjas BB
- RU** Нажимная ручка с розетками и накладками Ø 50 с отверстием для межкомнатного ключа



► Pag. 131



### Technical Informations

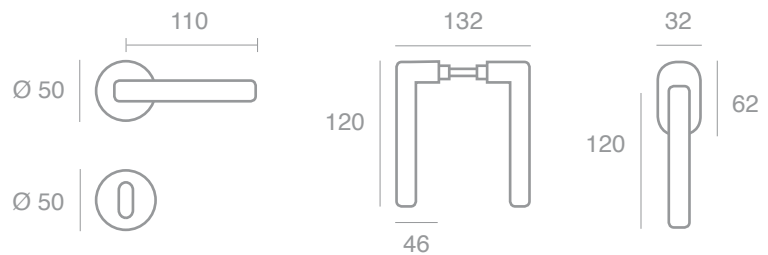

V21

# Venus

V218194B

- IT** Guarnitura maniglia con rosette e bocchette Ø 50 foro BB
- EN** Lever handle with roses and escutcheons Ø 50 BB hole
- ES** Juego de manijas con rosetas y bocallaves Ø 50 gorjas BB
- RU** Нажимная ручка с розетками и накладками Ø 50 с отверстием для межкомнатного ключа



▶ Pag. 131



### Technical Informations

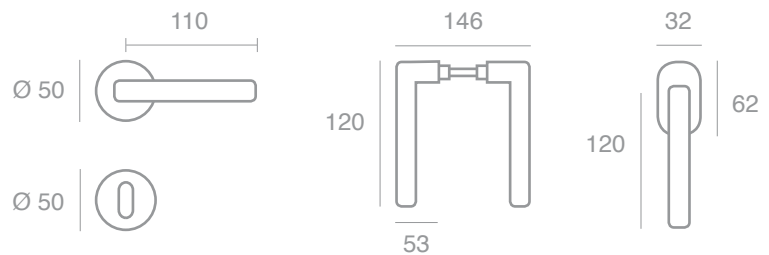

H15

# Haiti

H158194B

- IT** Guarnitura maniglia con rosette e bocchette Ø 50 foro BB
- EN** Lever handle with roses and escutcheons Ø 50 BB hole
- ES** Juego de manijas con rosetas y bocallaves Ø 50 gorjas BB
- RU** Нажимная ручка с розетками и накладками Ø 50 с отверстием для межкомнатного ключа



► Pag. 125



### Technical Informations

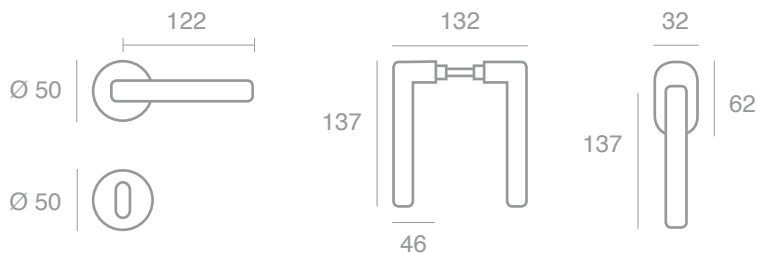

L18

# Londra

L188194Y

- IT** Guarnitura maniglia con rosette e bocchette Ø 50 foro Yale
- EN** Lever handle with roses and escutcheons Ø 50 PZ hole
- ES** Juego de manijas con rosetas y bocallaves Ø 50 Yale
- RU** Нажимная ручка с розетками и накладками Ø 50 с отверстием для цилиндра

**Finiture disponibili****F1 - F1 satinato**

Available finishing

F1 - satined F1

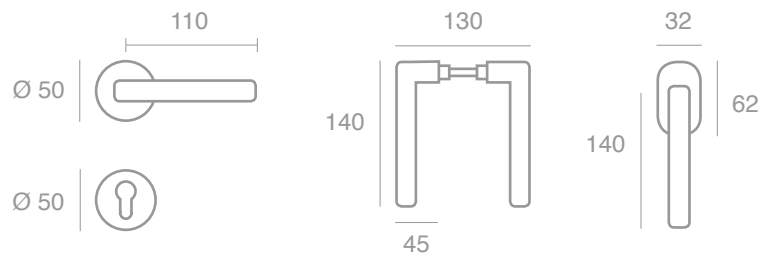

▶ Pag. 132

**Technical Informations**



A14

# Atene

A148595Y

- IT** Guarnitura maniglia con rosette e bocchette Ø 52 foro Yale
- EN** Lever handle with roses and escutcheons Ø 52 PZ hole
- ES** Juego de manijas con rosetas y bocallaves Ø 52 Yale
- RU** Нажимная ручка с розетками и накладками Ø 52 с отверстием для цилиндра



► Pag. 132



## Technical Informations

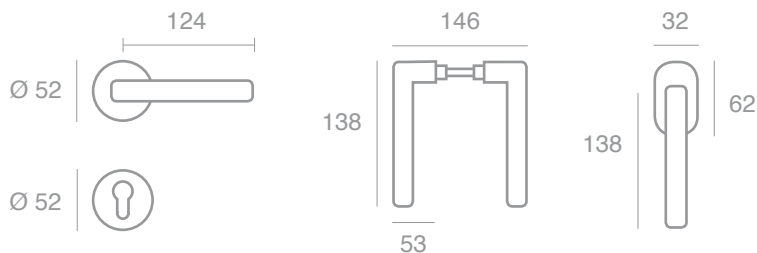

F22

# Firenze

F228498Y

- IT** Guarnitura maniglia con rosette e bocchette ovali foro Yale
- EN** Lever handle with oval roses and escutcheons PZ hole
- ES** Juego de manijas con rosetas y bocallaves ovals, Yale
- RU** Нажимная ручка с овальными розетками и накладками с отверстием для цилиндра



▶ Pag. 132



### Technical Informations

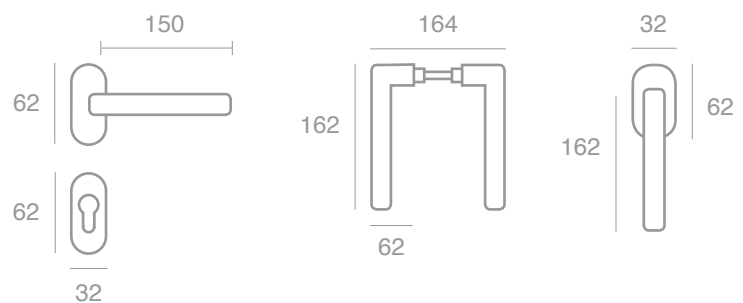

E06

# Everest

E068194B

- IT** Guarnitura maniglia con rosette e bocchette Ø 50 foro BB
- EN** Lever handle with roses and escutcheons Ø 50 BB hole
- ES** Juego de manijas con rosetas y bocallaves Ø 50 gorjas BB
- RU** Нажимная ручка с розетками и накладками Ø 50 с отверстием для межкомнатного ключа



► Pag. 133

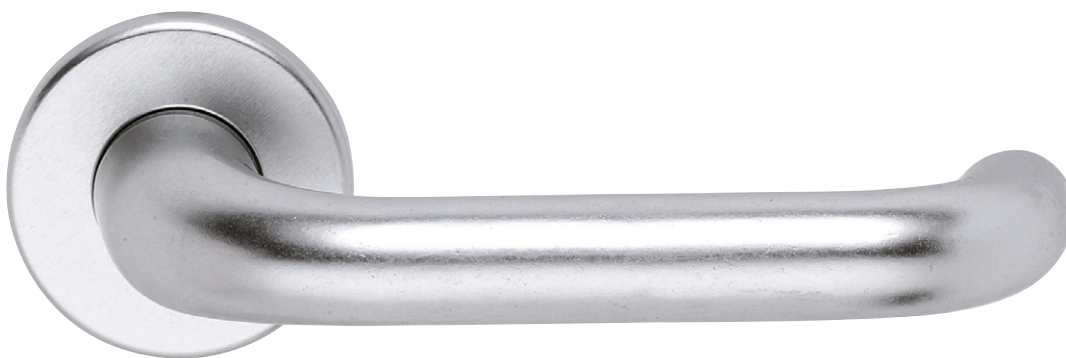

### Technical Informations

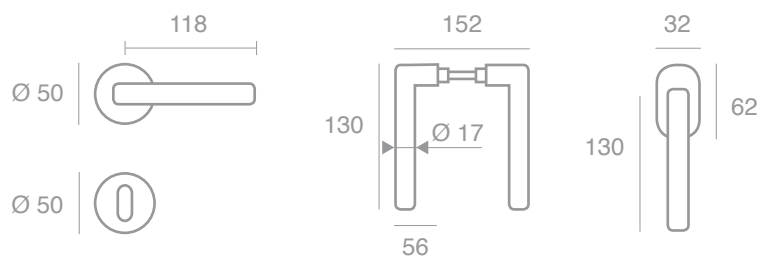

M16

# Madrid

M168595B

- IT** Guarnitura maniglia con rosette e bocchette Ø 52 foro BB
- EN** Lever handle with roses and escutcheons Ø 52 BB hole
- ES** Juego de manijas con rosetas y bocallaves Ø 52 gorjas BB
- RU** Нажимная ручка с розетками и накладками Ø 52 с отверстием для межкомнатного ключа



▶ Pag. 133



### Technical Informations

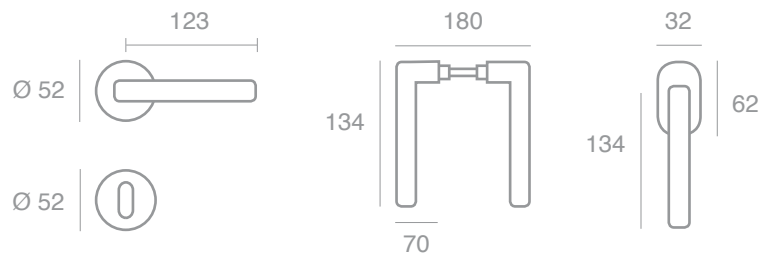

D20

# Dublino

D208194B

- IT** Guarnitura maniglia con rosette e bocchette Ø 50 foro BB
- EN** Lever handle with roses and escutcheons Ø 50 BB hole
- ES** Juego de manijas con rosetas y bocallaves Ø 50 gorjas BB
- RU** Нажимная ручка с розетками и накладками Ø 50 с отверстием для межкомнатного ключа



► Pag. 124



### Technical Informations

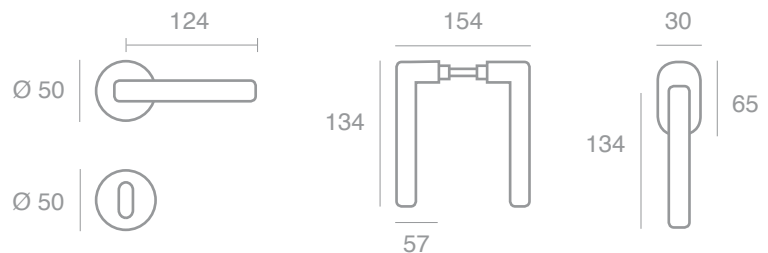

Z99

# Zagabria

Z998194Y

- IT** Guarnitura maniglia con rosette e bocchette Ø 50 foro Yale
- EN** Lever handle with roses and escutcheons Ø 50 PZ hole
- ES** Juego de manijas con rosetas y bocallaves Ø 50 Yale
- RU** Нажимная ручка с розетками и накладками Ø 50 с отверстием для цилиндра

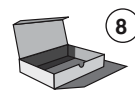

▶ Pag. 133



## Technical Informations

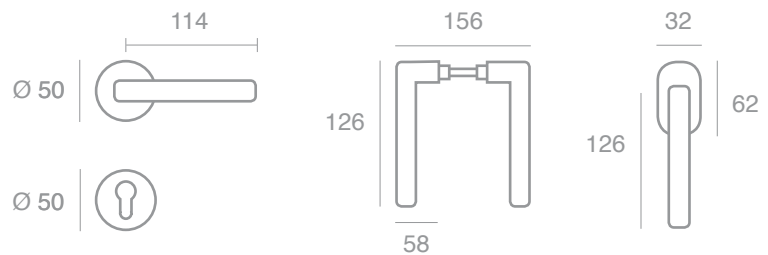

B25

# Bonn

B258498Y

- IT** Guarnitura maniglia con rosette e bocchette ovali foro Yale
- EN** Lever handle with oval roses and escutcheons PZ hole
- ES** Juego de manijas con rosetas y bocallaves ovales, Yale
- RU** Нажимная ручка с овальными розетками и накладками с отверстием для цилиндра

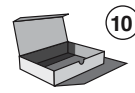

► Pag. 134



## Technical Informations

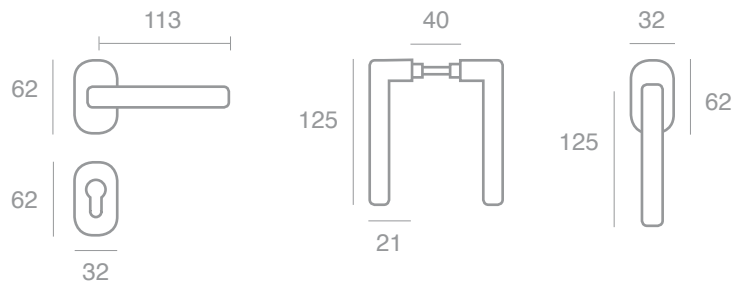

T10

# Toronto

T108194B

- IT** Guarnitura maniglia con rosette e bocchette Ø 50 foro BB
- EN** Lever handle with roses and escutcheons Ø 50 BB hole
- ES** Juego de manijas con rosetas y bocallaves Ø 50 gorjas BB
- RU** Нажимная ручка с розетками и накладками Ø 50 с отверстием для межкомнатного ключа



▶ Pag. 134



### Technical Informations

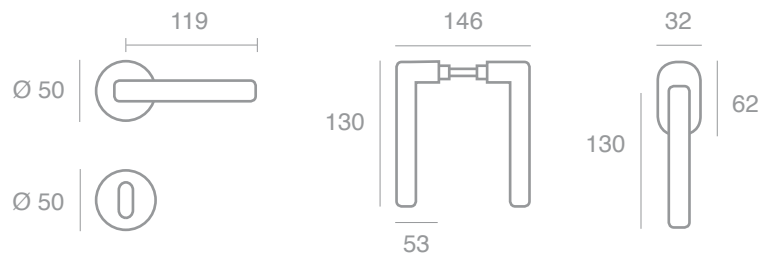



C11

# Sofia

C118194Y

- IT** Guarnitura maniglia con rosette e bocchette Ø 50 foro Yale
- EN** Lever handle with roses and escutcheons Ø 50 PZ hole
- ES** Juego de manijas con rosetas y bocallaves Ø 50 Yale
- RU** Нажимная ручка с розетками и накладками Ø 50 с отверстием для цилиндра



► Pag. 134



## Technical Informations

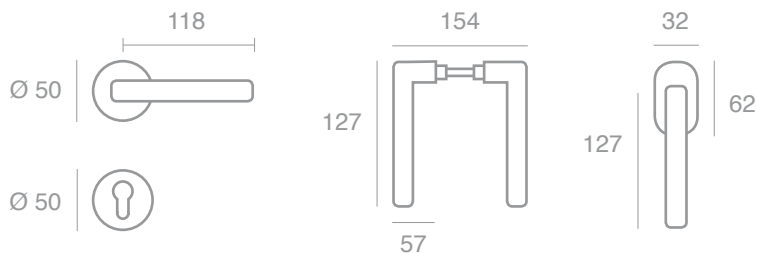

G01

# Ginevra

G018194P

- IT** Guarnitura maniglia con rosette e bocchette Ø 50 foro chiave
- EN** Lever handle with roses and escutcheons Ø 50 key hole
- ES** Juego de manijas con rosetas y bocallaves Ø 50, bocallaves gorjas
- RU** Пара ручек на розетке с накладкой Ø 50 с отверстием под кабинетный ключ



▶ Pag. 135



## Technical Informations

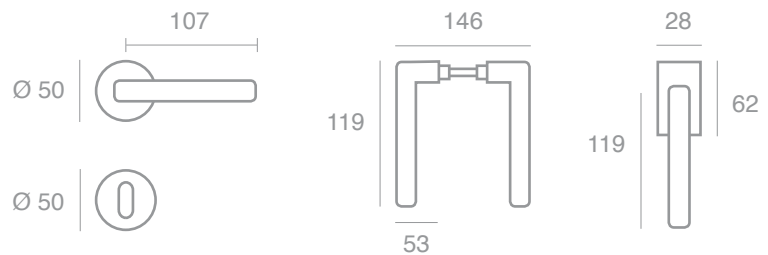

M12

# Melbourne

M128194P

- IT** Guarnitura maniglia con rosette e bocchette Ø 50 foro chiave
- EN** Lever handle with roses and escutcheons Ø 50 key hole
- ES** Juego de manijas con rosetas y bocallaves Ø 50, bocallaves gorjas
- RU** Пара ручек на розетке с накладкой Ø 50 с отверстием под кабинетный ключ



► Pag. 135



## Technical Informations

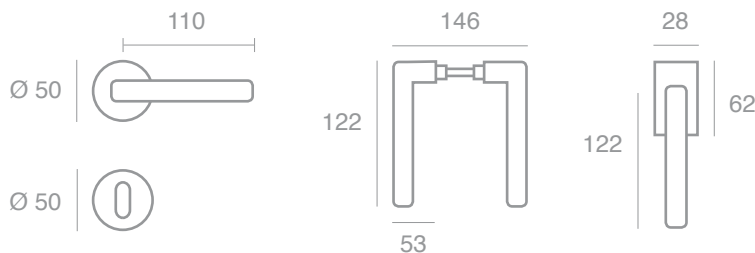

J05XL

# Japan XL

J05XL8194Y

- IT** Guarnitura maniglia con rosette e bocchette Ø 50 foro Yale
- EN** Lever handle with roses and escutcheons Ø 50 PZ hole
- ES** Juego de manijas con rosetas y bocallaves Ø 50
- RU** Нажимная ручка с розетками и накладками Ø 50 с отверстием для цилиндра



### Technical Informations

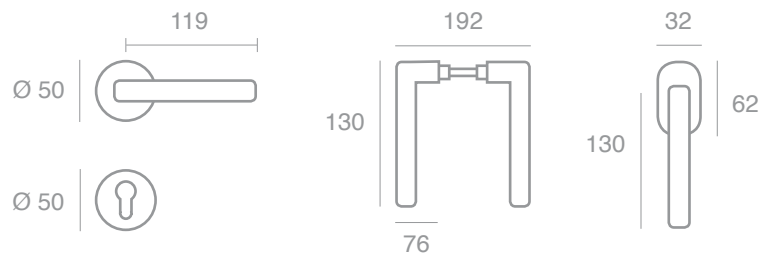

J05

# Japan

J058194P

- IT** Guarnitura maniglia con rosette e bocchette Ø 50 foro chiave
- EN** Lever handle with roses and escutcheons Ø 50 key hole
- ES** Juego de manijas con rosetas y bocallaves Ø 50, bocallaves gorjas
- RU** Пара ручек на розетке с накладкой Ø 50 с отверстием под кабинетный ключ



► Pag. 135

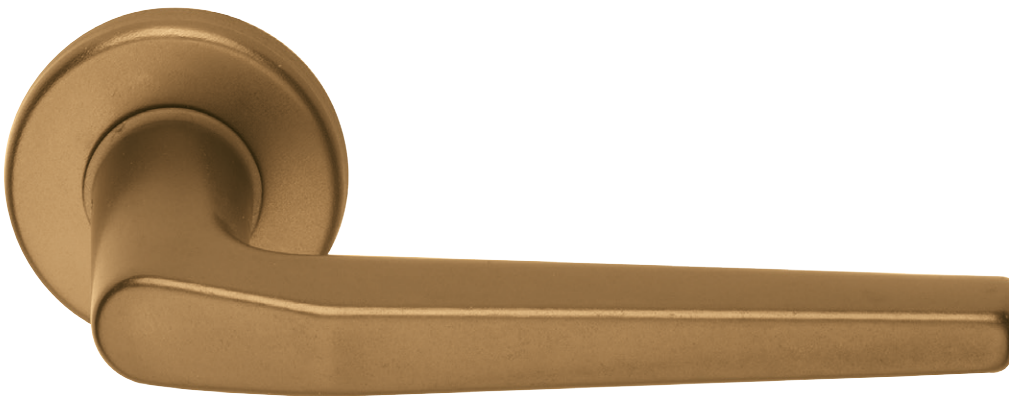

## Technical Informations

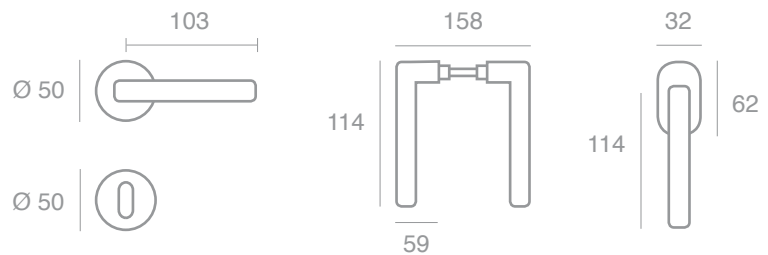

S02

# Sydney

S028194P

- IT** Guarnitura maniglia con rosette e bocchette Ø 50 foro chiave
- EN** Lever handle with roses and escutcheons Ø 50 key hole
- ES** Juego de manijas con rosetas y bocallaves Ø 50, bocallaves gorjas
- RU** Пара ручек на розетке с накладкой Ø 50 с отверстием под кабинетный ключ



▶ Pag. 136



## Technical Informations

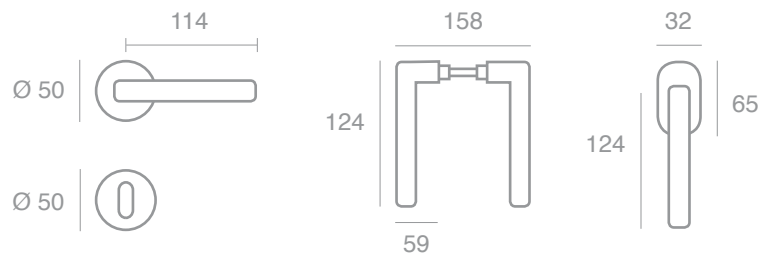

E08

# Egitto

E088194Y

- IT** Guarnitura maniglia con rosette e bocchette Ø 50 foro Yale
- EN** Lever handle with roses and escutcheons Ø 50 PZ hole
- ES** Juego de manijas con rosetas y bocallaves Ø 50 Yale
- RU** Нажимная ручка с розетками и накладками Ø 50 с отверстием для цилиндра

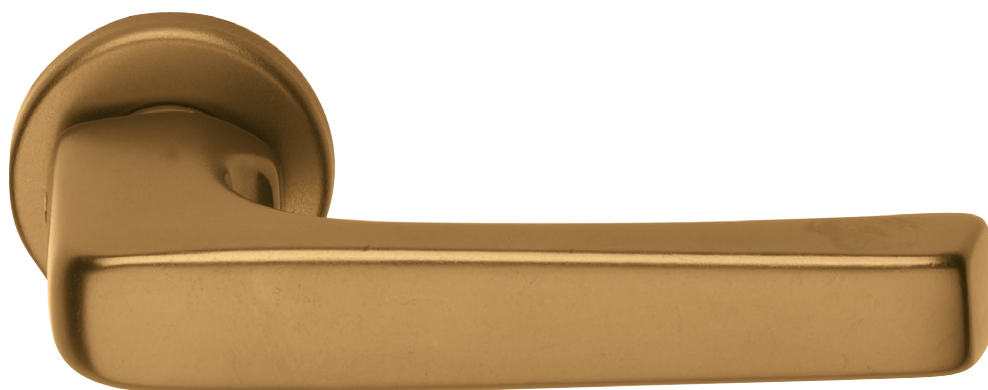

## Technical Informations

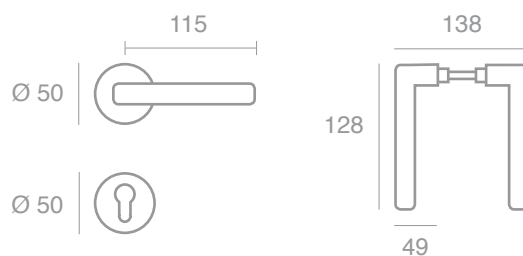

B09

# Berlino

B098194P

- IT** Guarnitura maniglia con rosette e bocchette Ø 50 foro chiave
- EN** Lever handle with roses and escutcheons Ø 50 key hole
- ES** Juego de manijas con rosetas y bocallaves Ø 50, bocallaves gorjas
- RU** Пара ручек на розетке с накладкой Ø 50 с отверстием под кабинетный ключ



## Technical Informations

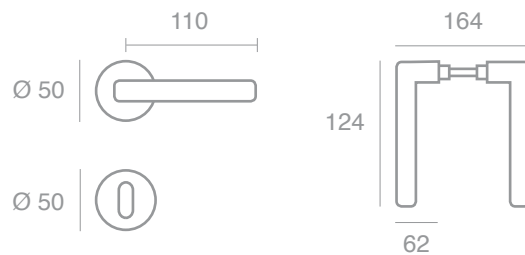



V07

# Venezia

V078194Y

- IT** Guarnitura maniglia con rosette e bocchette Ø 50 foro Yale
- EN** Lever handle with roses and escutcheons Ø 50 PZ hole
- ES** Juego de manijas con rosetas y bocallaves Ø 50 Yale
- RU** Нажимная ручка с розетками и накладками Ø 50 с отверстием для цилиндра

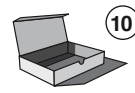

► Pag. 136

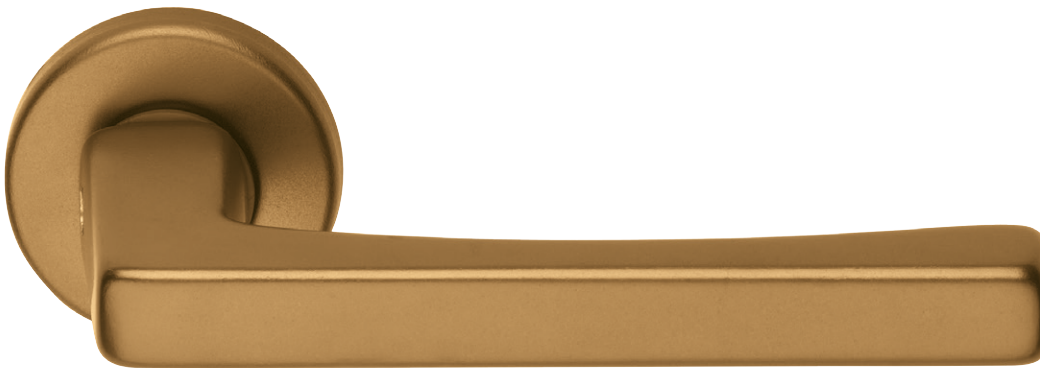

### Technical Informations

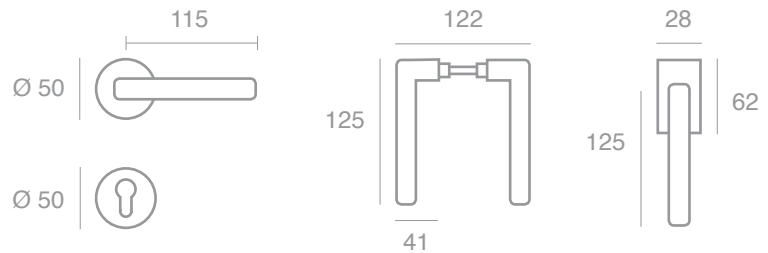

F13

# Florida

F138194B

- IT** Guarnitura maniglia con rosette e bocchette Ø 50 foro BB
- EN** Lever handle with roses and escutcheons Ø 50 BB hole
- ES** Juego de manijas con rosetas y bocallaves Ø 50 gorjas BB
- RU** Нажимная ручка с розетками и накладками Ø 50 с отверстием для межкомнатного ключа



► Pag. 136



## Technical Informations

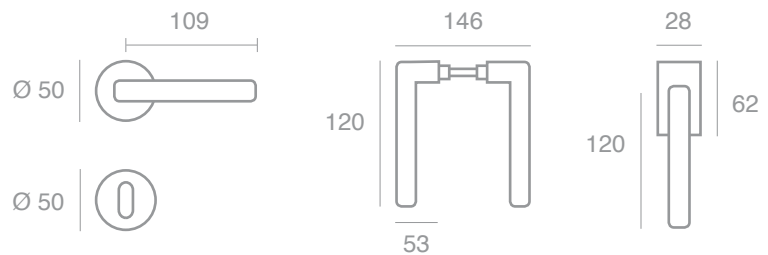

U04

# U4

U048194P

- IT** Guarnitura maniglia con rosette e bocchette Ø 50 foro chiave
- EN** Lever handle with roses and escutcheons Ø 50 key hole
- ES** Juego de manijas con rosetas y bocallaves Ø 50, bocallaves gorjas
- RU** Пара ручек на розетке с накладкой Ø 50 с отверстием под кабинетный ключ



► Pag. 137

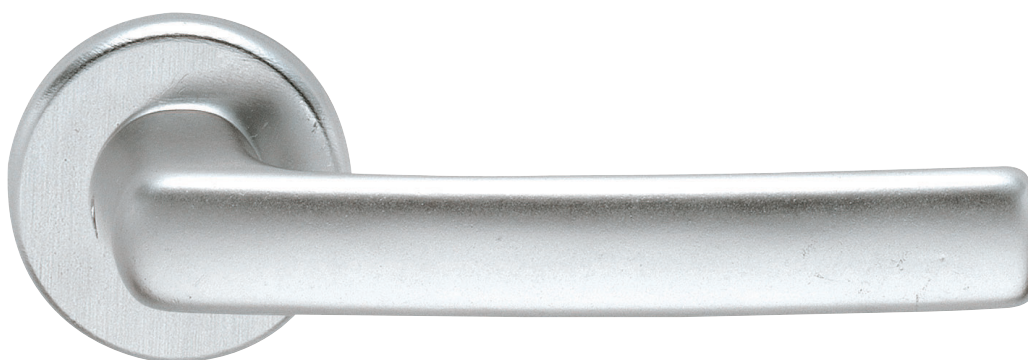

### Technical Informations

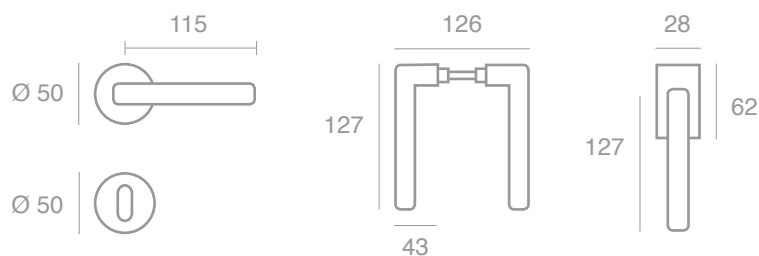



Italian Design Since 1972

**BRIALMA**  
made in italy  
since 1972



**Kit Porte**  
Kit Doors  
Kit Puertas  
КОМПЛЕКТ  
ПВХ

**Kit per porte PVC e Alluminio | Set for PVC and Aluminium doors**  
Kit para puertas PVC y Aluminio | Комплект для алюминиевых и ПВХ дверей

## A68333FY



### A68333FY

- IT** Guarnitura maniglia A68 su placca 3300 3 fori, con sottoplacca in acciaio, foro Yale
- EN** Lever handle A68 on plate type 3300 3 screw holes, with stainless steel underplate, PZ hole
- ES** Juego manilla A68 con placa tipo 3300 3 agujeros, con placa de acero, interior, Yale
- RU** Комплект нажимной ручки A68 на планке 3300 3 отверстия для винтов с под-пластиной из нержавеющей стали, отверстие для цилиндра



### Technical Informations

L available: 72 - 85 - 88 - 90 - 92

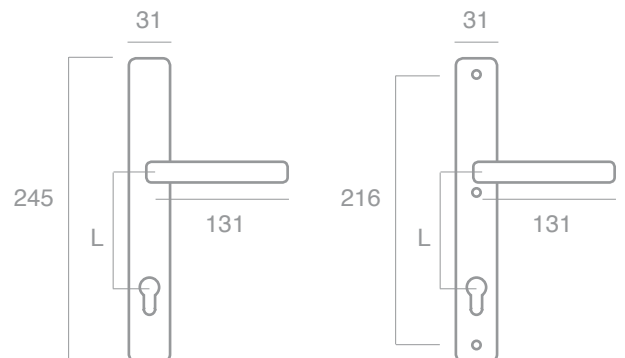

## PAL4863A68333FY



### PAL4863A68333FY

- IT** Kit pomolo PAL48 + maniglia A68 su placca 3300 3 fori vite, con sottopacca in acciaio, foro Yale
- EN** Kit knob PAL48+ handle A68 on plate type 3300 3 screw holes, with stainless steel underplate, PZ hole
- ES** Kit pomo PAL48 + manija A68 sobre placatipo 3300 3 agujeros para tornillos, con placa inferior en acero, bocallave Yale
- RU** Комплект knob PAL48+ручка A68 на планке 3300 с тремя отверстиями под винты, с планкой для фиксации из нержавеющей стали, фрезировка под евроцилиндр



### Technical Informations

L available: 72 - 85 - 88 - 90 - 92

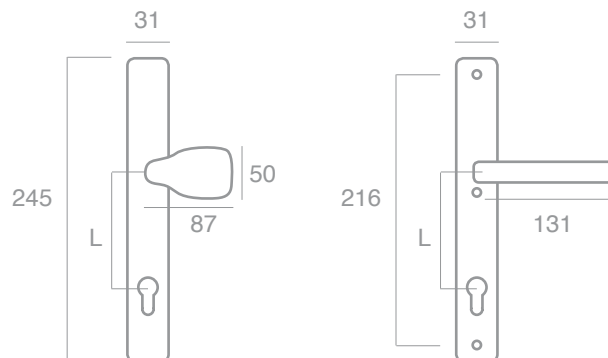

## PKS7063G30353FY



### PKS7063G30353FY

- IT** Kit pomolo PKS70 + maniglia G30 su placca 3500 3 fori vite, con sottoplacca in acciaio, foro Y
- EN** Kit knob PKS70 + handle G30 on plate type 3500 3 screw holes, with stainless steel underplate, PZ hole
- ES** Kit con pomolo PKS70 y manilla G30 con placa 3500, 3 agujeros
- RU** Комплект knob PKS70 + ручка G30 на овальной планке 3500 типа с 3 отверстиями для саморезов с пластиной из нержавеющей стали, с отверстием под цилиндр

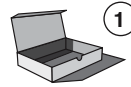

### Technical Informations

L available: 72 - 85 - 88 - 90 - 92

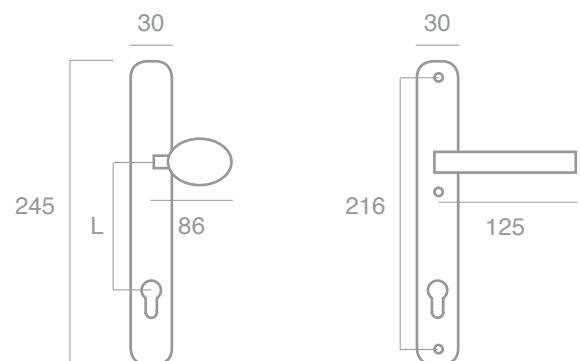



## G30353FY



### G30353FY

- IT** Guarnitura maniglia G30 su placca 3500 3 fori vite, con sottopacca in acciaio, foro Y
- EN** Lever handle G30 on plate type 3500 3 screw holes, with stainless steel underplate, PZ hole
- ES** Juego manilla G30 con placa tipo 3500 3 agujeros, con placa de acero, interior, Yale
- RU** Комплект нажимной ручки G30 на планке 3300 3 отверстия для винтов с подпластиной из нержавеющей стали, отверстие для цилиндра



### Technical Informations

L available: 72 - 85 - 88 - 90 - 92

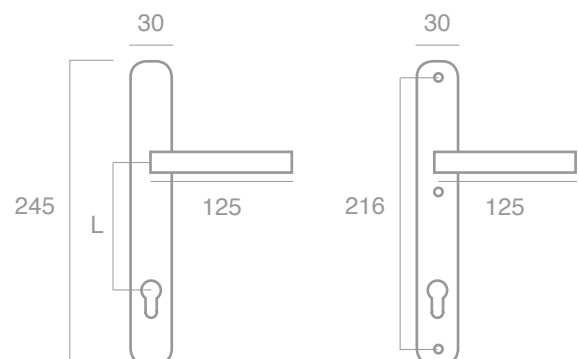

## 602063G30353FY

### 602063G30353FY

- IT** Kit maniglione 6020 + maniglia G30 su placca 3500 3 fori vite
- EN** Pull handle 6020 on plate type 3500 3 screw holes, with stainless steel underplate, PZ hole
- ES** Kit con manillon 6020 y manilla G30 con placa 3500 3 agujeros
- RU** Комплект ручки скобы 6020 + ручка G30 на планке 3500 3 отверстия для винтов, с под-пластиной из нержавеющей стали, отверстие для цилиндра



### Technical Informations

L available: 90 - 92

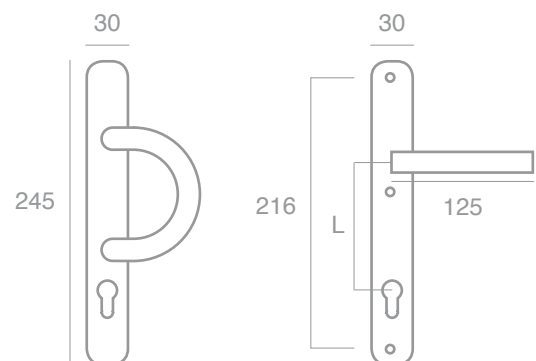

## 608563G30353FY



### 608563G30353FY

- IT** Kit maniglione 6085 + maniglia G30 su placca 3500 3 fori vite
- EN** Pull handle 6085 on plate type 3500 3 screw holes, with stainless steel underplate, PZ hole
- ES** Kit con manillon 6085 y manilla G30 con placa 3500 3 agujeros
- RU** Комплект ручки скобы 6085 + ручка G30 на планке 3500 3 отверстия для винтов, с под-пластиной из нержавеющей стали, отверстие для цилиндра



### Technical Informations

L available: 90 - 92

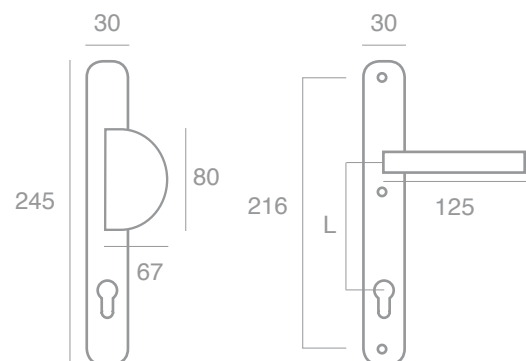



Italian Design Since 1972

**BRIALMA**  
made in italy  
since 1972



**Maniglioni**  
Pull Handles  
Manillones  
Ручки скобы

## 19000



### 19000

- IT** Singolo maniglione alzante quadro  
L. 250 mm. con placca cieca e nicchia quadra
- EN** Single square lift-slide handle, L. 250  
on blind plate with square flush pull handle.
- ES** Manillon cuadrado individual L. 250 con sistema levanta  
y desliza con placa ciega y nicho cuadrado.
- RU** Ручка раздельная для подъемно-раздвижной  
системы L.250 на глухой планке с квадратной  
врезной ручкой.



### Technical Informations

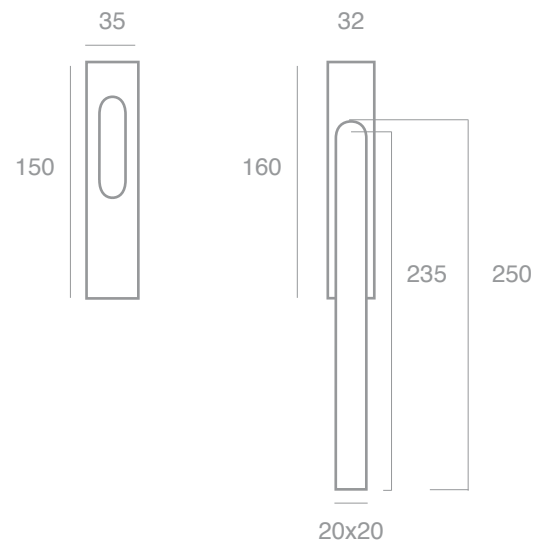

## 18050



### 18050

- IT** Singolo maniglione alzante, L.250 mm. con placca cieca e nicchia corta
- EN** Single lift-slide handle, L.250 on blind plate with short flush pull handle
- ES** Manillon individual L. 250 con sistema levanta y desliza con placa ciega y nicho corto.
- RU** Ручка раздельная для раздвижного приподнимателя L.250 на глухой планке с короткой врезной ручкой



### Technical Informations

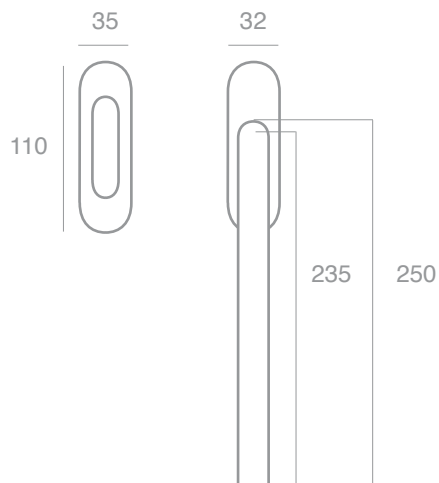

## 18000 | 18100 | 18200 | 18300 | 18400



- 18000**
- IT** Singolo maniglione alzante, L. 250 con placca cieca e nicchia
  - EN** Single lift-slide handle, L. 250 on blind plate with flush pull handle
  - ES** Manillon individual L.250 con sistema levanta y desliza con placa ciega y nicho
  - RU** Ручка раздельная для раздвижного приподнимателя L. 250 на глухой планке с врезной ручкой



- 18100**
- IT** Singolo maniglione alzante, L. 250 con placca foro Yale e nicchia
  - EN** Single lift-slide handle, L. 250 on Yale plate with flush pull handle
  - ES** Manillon individual L.250 con sistema levanta y desliza con placa ciega y nicho con bocallave Yale
  - RU** Ручка раздельная для раздвижного приподнимателя L. 250 на планке с отверстием для цилиндра с врезной ручкой



- 18200**
- IT** Coppia maniglioni alzanti, L. 250 con placca foro Yale senza nicchia
  - EN** Pair of lift-slide handle, L. 250 on Yale plate without flush pull handle
  - ES** Par de Manillones L.250 con sistema levanta y desliza con placa con bocallave Yale
  - RU** Пара ручек для раздвижного приподнимателя L. 250 на планке с отверстием для цилиндра



- 18300**
- IT** Singolo maniglione alzante, L.250 con placca cieca senza nicchia
  - EN** Single lift-slide handle, L.250 on blind plate without flush pull handle
  - ES** Manillon individual L.250 con sistema levanta y desliza con placa ciega sin nicho
  - RU** Ручка раздельная для раздвижного приподнимателя L.250 на глухой планке



- 18400**
- IT** Singolo maniglione alzante, L. 250 con placca foro Yale senza nicchia
  - EN** Single lift-slide handle, L. 250 on Yale plate without flush pull handle
  - ES** Manillon individual L.250 con sistema levanta y desliza con placa con bocallave Yale sin nicho
  - RU** Ручка раздельная для раздвижного приподнимателя L. 250 на планке с отверстием для цилиндра



## Technical Informations

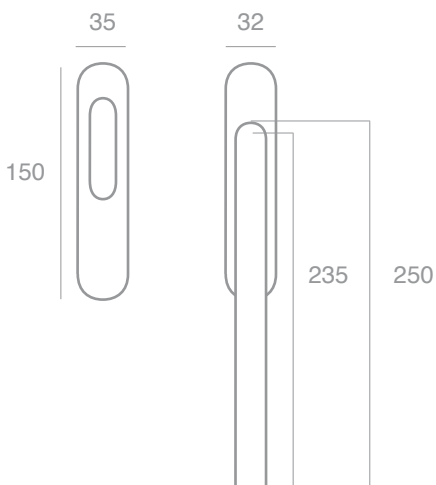



**17000 | 17100 | 17200 | 17300 | 17400**



- 17000**
- IT** Singolo maniglione alzante, L.185 con placca cieca e nicchia
  - EN** Single lift-slide handle, L.185 on blind plate with flush pull handle
  - ES** Manillon individual L.185 con sistema levanta y desliza con placa ciega y nicho
  - RU** Ручка раздельная для раздвижного приподнимателя L.185 на глухой планке с врезной ручкой



- 17100**
- IT** Singolo maniglione alzante, L.185 con placca foro Yale e nicchia
  - EN** Single lift-slide handle, L.185 on Yale plate with flush pull handle
  - ES** Manillon individual L.185 con sistema levanta y desliza con placa ciega y nicho con bocallave Yale
  - RU** Ручка раздельная для раздвижного приподнимателя L.185 на планке с отверстием для цилиндра с врезной ручкой



- 17200**
- IT** Coppia maniglioni alzanti, L.185 con placca foro Yale senza nicchia
  - EN** Pair of lift-slide handle, L.185 on Yale plate without flush pull handle
  - ES** Par de Manillones L.185 con sistema levanta y desliza con placa con bocallave Yale
  - RU** Пара ручек для раздвижного приподнимателя L.185 на планке с отверстием для цилиндра



- 17300**
- IT** Singolo maniglione alzante, L.185 con placca cieca senza nicchia
  - EN** Single lift-slide handle, L.185 on blind plate without flush pull handle
  - ES** Manillon individual L.185 con sistema levanta y desliza con placa ciega sin nicho
  - RU** Ручка раздельная для раздвижного приподнимателя L.185 на глухой планке.



- 17400**
- IT** Singolo maniglione alzante, L.185 con placca foro Yale senza nicchia
  - EN** Single lift-slide handle, L.185 on Yale plate without flush pull handle.
  - ES** Manillon individual L.185 con sistema levanta y desliza con placa con bocallave Yale sin nicho.
  - RU** Ручка раздельная для раздвижного приподнимателя L.185 на планке с отверстием для цилиндра



**Technical Informations**

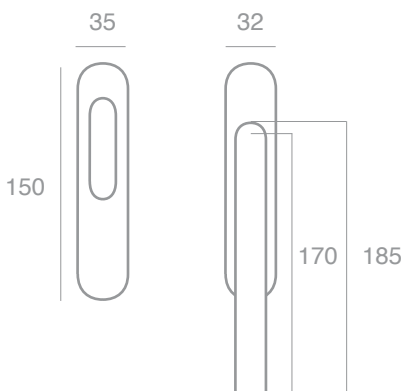

**6200**



- 6200** **IT** Maniglione sezione quadrata 25x25, lunghezza L, interasse D
- EN** Square pull handle 25x25, length L, distance screw D
- ES** Manija de sección cuadrada 25x25, longitud L, distancia entre ejes D
- RU** Стационарная дверная ручка-скоба с квадратным сечением 25x25, высота L, межосевое расстояние D



lunghezza	interasse
length	distance screw
longitud	distancia entre ejes
длина	межосевое расстояние
L 400 mm	D 300 mm
L 600 mm	D 400 mm
L 800 mm	D 600 mm
L 1000 mm	D 700 mm
L 1200 mm	D 900 mm
L 1400 mm	D 1000 mm
L 1600 mm	D 1200 mm

**Technical Informations**

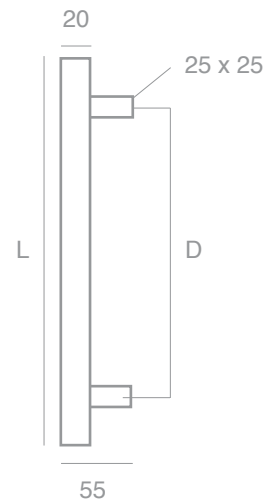

- **Pag. 186** **Componenti per fissaggio**  
For fixing square parts  
Kit componentes para fijación  
Комплект компонентов для фиксации

## 6210



- 6210**
- IT** Maniglione sezione quadrata 20x20, lunghezza L, interasse D
  - EN** Square pull handle 20x20, length L, distance screw D
  - ES** Manija de sección cuadrada 20x20, longitud L, distancia entre ejes D
  - RU** Стационарная дверная ручка-скоба с квадратным сечением 20x20, высота L, межосевое расстояние D



lunghezza	interasse
length	distance screw
longitud	distancia entre ejes
длина	межосевое расстояние

L 400 mm	D 300 mm
L 600 mm	D 400 mm
L 800 mm	D 600 mm
L 1000 mm	D 700 mm
L 1200 mm	D 900 mm
L 1400 mm	D 1000 mm
L 1600 mm	D 1200 mm

### Technical Informations

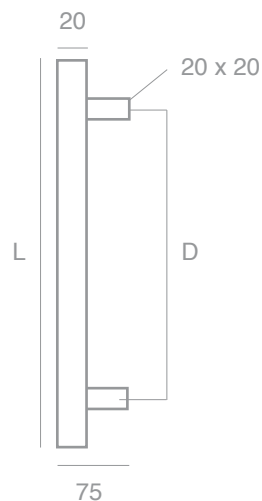

- **Pag. 186** **Componenti per fissaggio**  
For fixing square parts  
Kit componentes para fijación  
Комплект компонентов  
для фиксации

**6220**



- IT** Maniglione sezione quadrata 20x20, lunghezza L, interasse D
- EN** Square pull handle 20x20, length L, distance screw D
- ES** Manillon cuadrado 20x20, largo L, distancia entre ejes D
- RU** Квадратная ручка скоба 20x20, длина L, межосевое расстояние D



lunghezza	interasse
length	distance screw
longitud	distancia entre ejes
длина	межосевое расстояние
<hr/>	
L 400 mm	D 380 mm
L 600 mm	D 580 mm
L 800 mm	D 780 mm
L 1000 mm	D 980 mm

**Technical Informations**

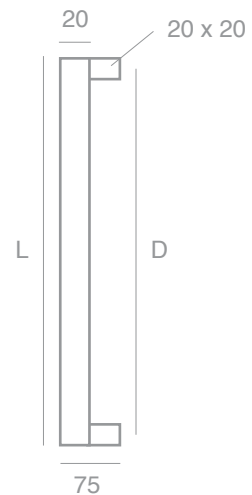

► **Pag. 186 Componenti per fissaggio**  
 For fixing square parts  
 Kit componentes para fijación  
 Комплект компонентов для фиксации

## 6500



- 6500**
- IT** Maniglione sezione quadrata 25x25, lunghezza L, interasse D
  - EN** Square pull handle 25x25, length L, distance screw D
  - ES** Manillon cuadrado 25x25, largo L, distancia entre ejes D
  - RU** Квадратная ручка скоба 25x25, длина L, межосевое расстояние D



lunghezza	interasse
length	distance screw
longitud	distancia entre ejes
длина	межосевое расстояние

L 400 mm	D 300 mm
L 600 mm	D 400 mm
L 800 mm	D 600 mm
L 1000 mm	D 700 mm
L 1200 mm	D 900 mm
L 1400 mm	D 1000 mm
L 1600 mm	D 1200 mm

### Technical Informations

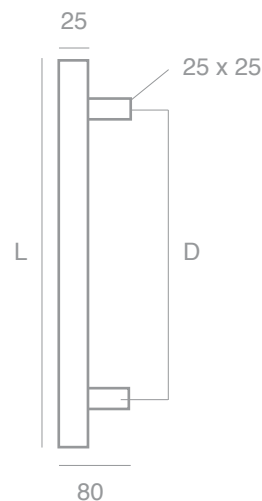

- **Pag. 186** **Componenti per fissaggio**  
For fixing square parts  
Kit componentes para fijación  
Комплект компонентов  
для фиксации

**6510**



- 6510** **IT** Maniglione sezione quadrata 25x25, lunghezza L, interasse D
- EN** Square pull handle 25x25, length L, distance screw D
- ES** Manillon cuadrado 25x25, largo L, distancia entre ejes D
- RU** Квадратная ручка скоба 25x25, длина L, межосевое расстояние D



lunghezza	interasse
length	distance screw
longitud	distancia entre ejes
длина	далеко от отверстия
<hr style="border-top: 1px dashed black;"/>	
L 400 mm	D 375 mm
L 800 mm	D 775 mm
L 1000 mm	D 975 mm

**Technical Informations**

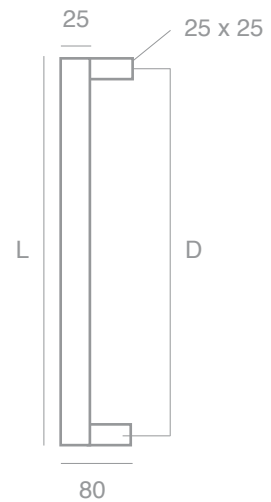

► **Pag. 186** **Componenti per fissaggio**  
 For fixing square parts  
 Kit componentes para fijación  
 Комплект компонентов для фиксации

## 6515



6515

- IT** Maniglione sezione quadrata 25x25, lunghezza L, interasse D, inclinato 45°
- EN** Square pull handle 25x25, length L, distance screw D
- ES** Manija de sección cuadrada 25x25, longitud L, distancia entre ejes D, inclinado 45°
- RU** Стационарная дверная ручка-скоба с квадратным сечением 25x25, высота L, межосевое расстояние D, угол наклона 45°



<b>lunghezza</b>	<b>interasse</b>
length	distance screw
longitud	distancia entre ejes
длина	далеко от отверстия

L 400 mm	D 300 mm
L 600 mm	D 400 mm
L 800 mm	D 600 mm
L 1000 mm	D 700 mm
L 1600 mm	D 1200 mm
L 2000 mm	D 2000 mm

### Technical Informations

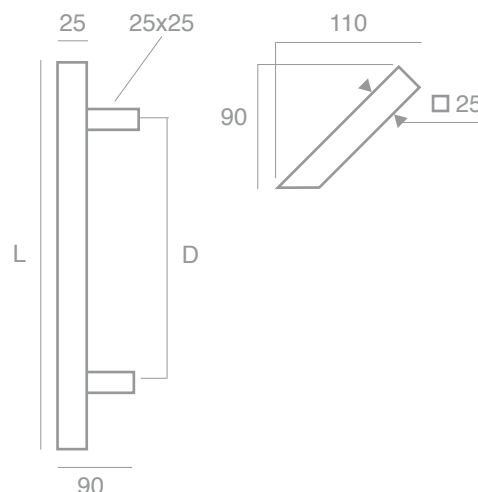

- **Pag. 186** **Componenti per fissaggio**  
For fixing square parts  
Kit componentes para fijación  
Комплект компонентов  
для фиксации

## 6400



- 6400**
- IT** Manigione sezione quadrata 30x30, lunghezza L, interasse D
  - EN** Square pull handle 30x30, length L, distance screw D
  - ES** Manillon cuadrado 30x30, largo L, distancia entre ejes D
  - RU** Квадратная ручка скоба 30x30, длина L, межосевое расстояние D



lunghezza	interasse
length	distance screw
longitud	distancia entre ejes
длина	далеко от отверстия

L 300 mm	D 200 mm
L 400 mm	D 300 mm
L 500 mm	D 300 mm
L 600 mm	D 400 mm
L 800 mm	D 600 mm
L 1000 mm	D 700 mm
L 1200 mm	D 900 mm
L 1400 mm	D 1000 mm
L 1500 mm	D 1100 mm
L 1600 mm	D 1200 mm
L 1800 mm	D 1400 mm
L 2000 mm	D 1500 mm

### Technical Informations

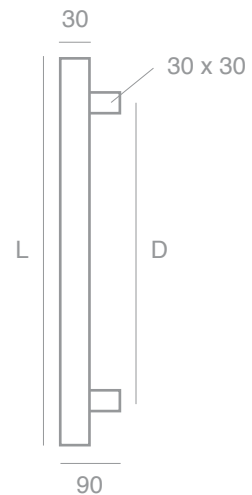

- **Pag. 186** **Componenti per fissaggio**  
 For fixing square parts  
 Kit componentes para fijación  
 Комплект компонентов для фиксации



## 6410



- 6410**
- IT** Maniglione sezione quadrata 30x30, lunghezza L, interasse D
  - EN** Square pull handle 30x30, length L, distance screw D
  - ES** Manillon cuadrado 30x30, largo L, distancia entre ejes D
  - RU** Квадратная ручка скоба 30x30, длина L, межосевое расстояние D



lunghezza	interasse
length	distance screw
longitud	distancia entre ejes
длина	далеко от отверстия
<hr/>	
L 300 mm	D 270 mm
L 400 mm	D 370 mm
L 600 mm	D 570 mm
L 800 mm	D 770 mm
L 1000 mm	D 970 mm

### Technical Informations

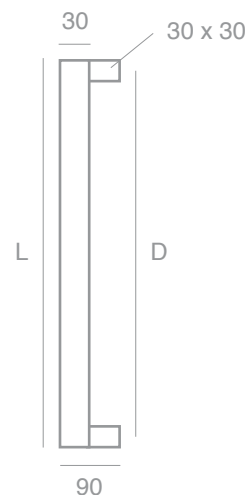

- **Pag. 186** **Componenti per fissaggio**  
For fixing square parts  
Kit componentes para fijación  
Комплект компонентов  
для фиксации

## 6415

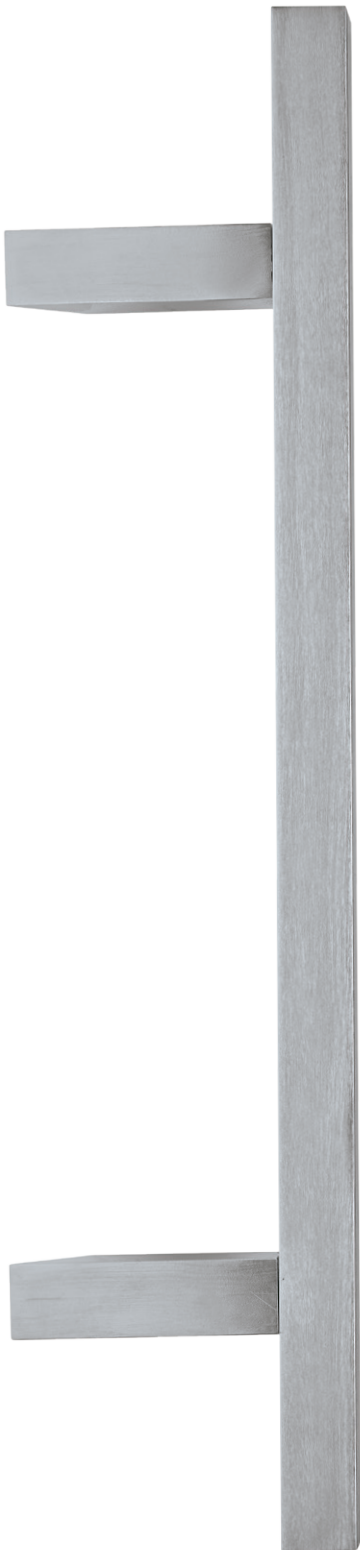

<b>lunghezza</b>	<b>interasse</b>
length	distance screw
longitud	distancia entre ejes
длина	далеко от отверстия

L 300 mm	D 200 mm
L 400 mm	D 300 mm
L 500 mm	D 300 mm
L 600 mm	D 400 mm
L 800 mm	D 600 mm
L 1000 mm	D 700 mm
L 1200 mm	D 900 mm
L 1400 mm	D 1000 mm
L 1500 mm	D 1100 mm
L 1600 mm	D 1200 mm
L 1800 mm	D 1400 mm
L 2000 mm	D 1500 mm



- 6415** **IT** Maniglione sezione quadrata 30x30, lunghezza L, interasse D, inclinato 45°
- EN** Square pull handle 30x30, length L, distance screw D, inclined by 45°
- ES** Manija de sección cuadrada 30x30, longitud L, distancia entre ejes D, inclinado 45°
- RU** Стационарная дверная ручка-скоба с квадратным сечением 30x30, высота L, межосевое расстояние D, угол наклона 45°



### Technical Informations

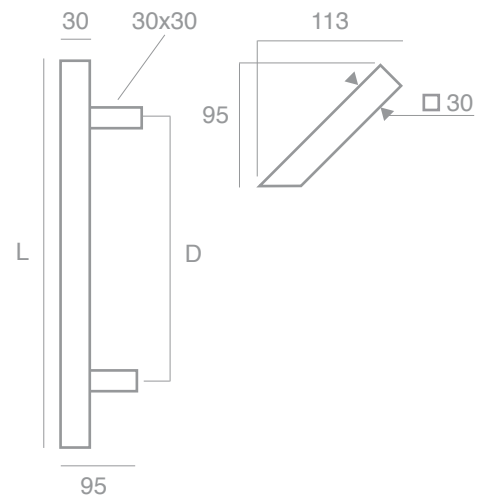

**Pag. 186** **Componenti per fissaggio**  
 For fixing square parts  
 Kit componentes para fijación  
 Комплект компонентов  
 для фиксации

## 6300



- 6300**
- IT** Maniglione sezione tonda Ø 22, lunghezza L, interasse D
  - EN** Pull handle Ø 22, length L, distance screw D
  - ES** Manillon redondo Ø 22, largo L, distancia entre ejes D
  - RU** Круглая ручка скоба Ø 22, длина L, межосевое расстояние D



lunghezza	interasse
length	distance screw
longitud	distancia entre ejes
длина	далеко от отверстия
L 300 mm	D 200 mm
L 400 mm	D 300 mm
L 600 mm	D 400 mm
L 800 mm	D 600 mm
L 1000 mm	D 800 mm

### Technical Informations

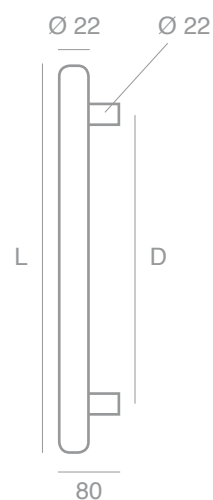

- Pag. 186 **Componenti per fissaggio**  
For fixing square parts  
Kit componentes para fijación  
Комплект компонентов  
для фиксации

## 6310



- 6310**
- IT** Maniglione sezione tonda Ø 30, lunghezza L, interasse D
  - EN** Pull handle Ø 30, length L, distance screw D
  - ES** Manillon cuadrado Ø 30, largo L, distancia entre ejes D
  - RU** Квадратная ручка скоба Ø 30, длина L, межосевое расстояние D



<b>lunghezza</b>	<b>interasse</b>
length	distance screw
longitud	distancia entre ejes
длина	межосевое расстояние

L 300 mm	D 200 mm
L 400 mm	D 300 mm
L 500 mm	D 300 mm
L 600 mm	D 400 mm
L 800 mm	D 600 mm
L 1000 mm	D 800 mm
L 1200 mm	D 900 mm
L 1400 mm	D 1000 mm
L 1500 mm	D 1100 mm
L 1600 mm	D 1200 mm
L 1800 mm	D 1400 mm
L 2000 mm	D 1500 mm

### Technical Informations

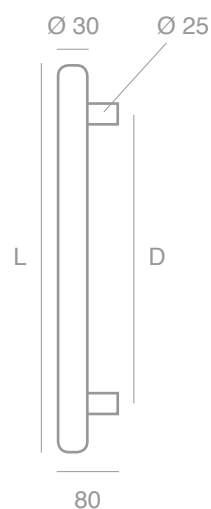

- **Pag. 186** **Componenti per fissaggio**  
 For fixing square parts  
 Kit componentes para fijación  
 Комплект компонентов  
 для фиксации

## 6315

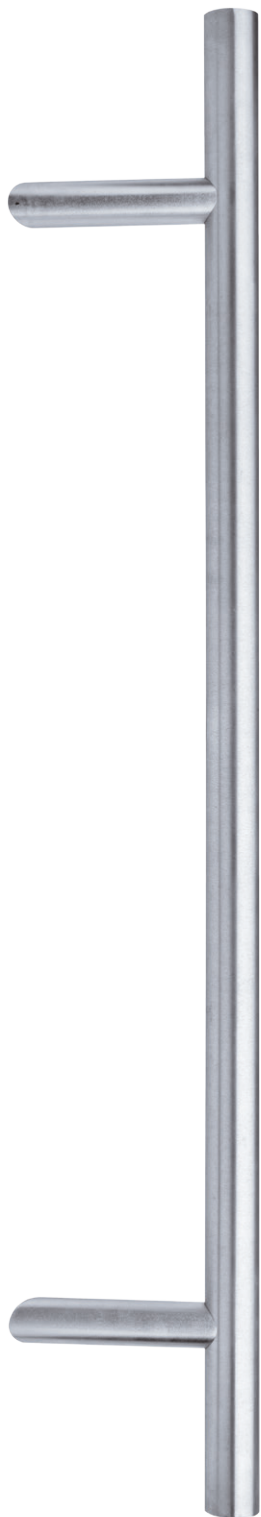

lunghezza	interasse
length	distance screw
longitud	distancia entre ejes
длина	межосевое расстояние

L 300 mm	D 200 mm
L 400 mm	D 300 mm
L 500 mm	D 300 mm
L 600 mm	D 400 mm
L 800 mm	D 600 mm
L 1000 mm	D 700 mm
L 1200 mm	D 900 mm
L 1400 mm	D 1000 mm
L 1500 mm	D 1100 mm
L 1600 mm	D 1200 mm
L 1800 mm	D 1400 mm
L 2000 mm	D 1500 mm



6515

**IT** Maniglione sezione tonda Ø 30, lunghezza L, interasse D, inclinato 45°

**EN** Pull handle Ø 30, length L, distance screw D inclined by 45°

**ES** Manija sección redonda Ø30, longitud L, distancia entre ejes D, inclinado 45°

**RU** Стационарная дверная ручка-скоба с круглым сечением 25x25, высота L, межосевое расстояние D, угол наклона 45°



### Technical Informations

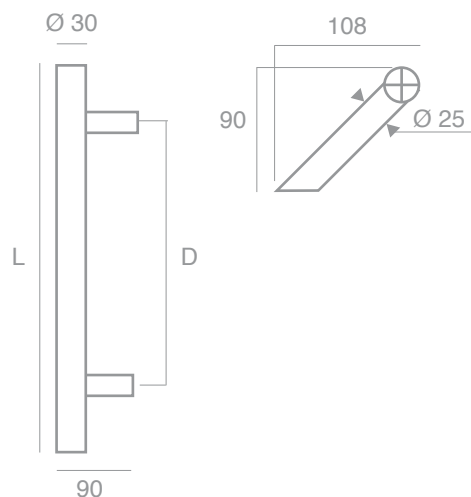

► Pag. 186 **Componenti per fissaggio**

For fixing square parts  
Kit componentes para fijación  
Комплект компонентов  
для фиксации

## 6001



- 6001**
- IT** Maniglione lunghezza 278
  - EN** Pull handle length 278
  - ES** Manillon largo 278 mm
  - RU** Ручка скоба длина 278 мм

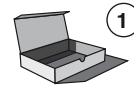

### Technical Informations

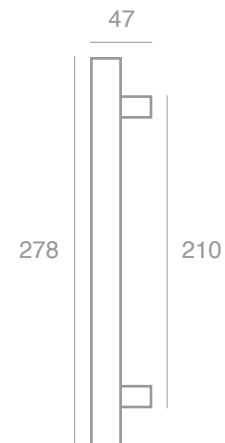

- **Pag. 186** **Componenti per fissaggio**  
For fixing square parts  
Kit componentes para fijación  
Комплект компонентов  
для фиксации

**6003**



**6003**

- IT** Maniglione lunghezza 278
- EN** Pull handle length 278
- ES** Manillon largo 278 mm
- RU** Ручка скоба длина 278 мм



#### Technical Informations

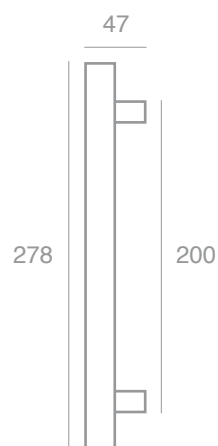

- **Pag. 186 Componenti per fissaggio**  
For fixing square parts  
Kit componentes para fijación  
Комплект компонентов  
для фиксации

## 6005



6005

- IT** Maniglione lunghezza 265
- EN** Pull handle length 265
- ES** Manillon largo 265 mm
- RU** ручка скоба длина 265 мм

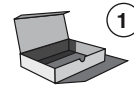

### Technical Informations

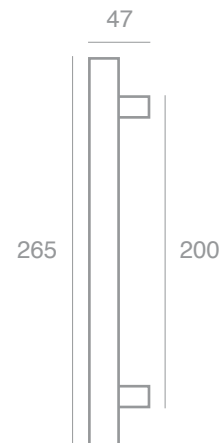

- **Pag. 186** **Componenti per fissaggio**  
For fixing square parts  
Kit componentes para fijación  
Комплект компонентов  
для фиксации



**6007**



**6007**

- IT** Maniglione lunghezza 265
- EN** Pull handle length 265
- ES** Manillon largo 265 mm
- RU** ручка скоба длина 265 мм



**Technical Informations**

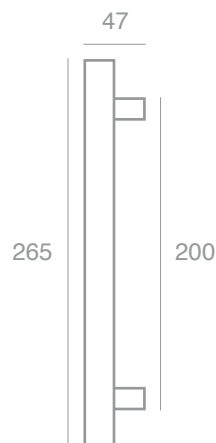

- **Pag. 186 Componenti per fissaggio**  
For fixing square parts  
Kit componentes para fijación  
Комплект компонентов  
для фиксации

6000



6050



602081



► Pag. 186 **Componenti per fissaggio**  
 For fixing square parts  
 Kit componentes para fijación  
 Комплект компонентов  
 для фиксации

**6000** **IT** Maniglione a ponte  
**EN** Large pull handle  
**ES** Manillon en forma de puente  
**RU** Ручка скоба



**Technical Informations**

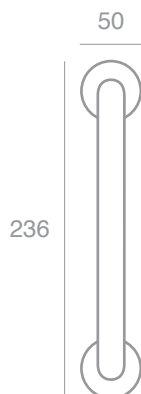

**6050** **IT** Coppia di maniglione a ponte **602081**  
**EN** Pair of large pull handles  
**ES** Par de manijas a puente  
**RU** Пара стационарных дверных  
 ручек закругленной формы



**Technical Informations**

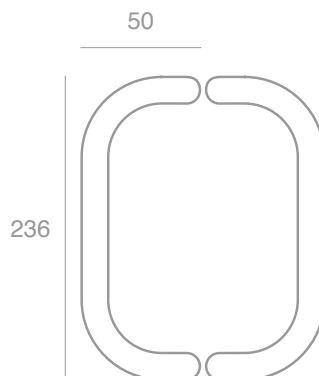

**602081** **IT** Maniglione 6020 su rosetta Ø 50  
**EN** Pull handle 6020 on roses Ø 50  
**ES** Manillon 6020 con roseta Ø 50  
**RU** Ручка скоба 6020  
 на круглой розете Ø 50



**Technical Informations**

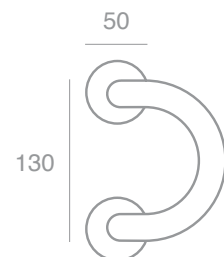

## 6030



### 603024

- IT** Maniglione a ponte 6030 su placca 2400
- EN** Pull handle 6030 on plate type 2400
- ES** Manillón en forma de puente 6030 con placa 2400
- RU** Ручка скоба 6030 типа на планке 2400 типа

#### Technical Informations

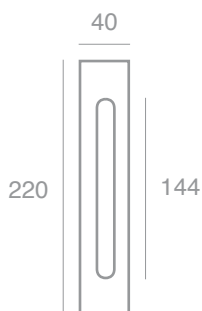

## 6010



### 601024Y

- IT** Maniglione a ponte con placca a foro Yale
- EN** Large pull handle with plate PZ hole
- ES** Manillón en forma de puente con placa bocallaves Yale
- RU** большая ручка скоба на плаке с отверстием под цилиндр

#### Technical Informations

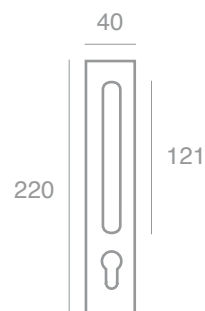



Italian Design Since 1972

**BRIALMA**  
made in italy  
since 1972



Pomoli  
Knobs  
Pomos  
КНОБЫ

**PMG99**

PMG9950

- IT** Bilancino pomolo
- EN** Pair of knobs
- ES** Juego de pomos sin rosetas
- RU** Пара кнобов

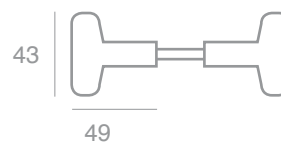
**Technical Informations****PCR54**

PCR5450

- IT** Bilancino pomolo
- EN** Pair of knobs
- ES** Juego de pomos sin rosetas
- RU** Пара кнобов

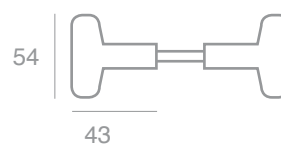
**Technical Informations****PLI64**

PLI6460

- IT** Pomolo con rosetta Ø 50
- EN** Knob with rose Ø 50
- ES** Pomo con roseta Ø 50
- RU** Кноб на розетке Ø 50

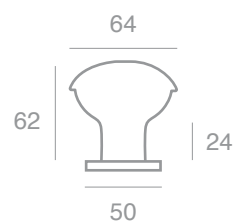
**Technical Informations**

## PSS61



PSS6160

- IT** Pomolo con rosetta Ø 50
- EN** Knob with rose Ø 50
- ES** Pomo con roseta Ø 50
- RU** Кноб на розетке Ø 50



### Technical Informations

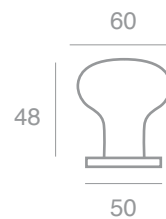

## PBR60



PBR6060

- IT** Pomolo con rosetta Ø 50
- EN** Knob with rose Ø 50
- ES** Pomo con roseta Ø 50
- RU** Кноб на розетке Ø 50



### Technical Informations



## PUN70



PUN7060

- IT** Pomolo con rosetta Ø 50
- EN** Knob with rose Ø 50
- ES** Pomo con roseta Ø 50
- RU** Кноб на розетке Ø 50



### Technical Informations



**PMA44**

PMA4460

- IT** Pomolo con rosetta Ø 50
- EN** Knob with rose Ø 50
- ES** Pomo con roseta Ø 50
- RU** Кноб на розетке Ø 50

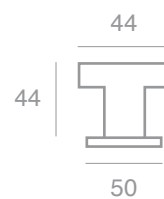
**Technical Informations****PMA50**

PMA5060

- IT** Pomolo con rosetta Ø 50
- EN** Knob with rose Ø 50
- ES** Pomo con roseta Ø 50
- RU** Кноб на розетке Ø 50

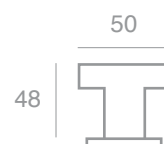
**Technical Informations****PMA56**

PMA5660

- IT** Pomolo con rosetta Ø 50
- EN** Knob with rose Ø 50
- ES** Pomo con roseta Ø 50
- RU** Кноб на розетке Ø 50

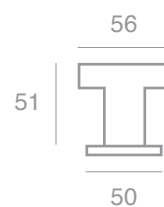
**Technical Informations**



## PBC60



PBC6060

- IT** Pomolo con rosetta Ø 50
- EN** Knob with rose Ø 50
- ES** Pomo con roseta Ø 50
- RU** Кноб на розетке Ø 50



### Technical Informations

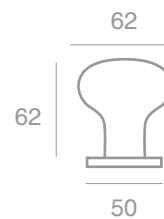

## PTR60



PTR6060

- IT** Pomolo con rosetta Ø 50
- EN** Knob with rose Ø 50
- ES** Pomo con roseta Ø 50
- RU** Кноб на розетке Ø 50



### Technical Informations

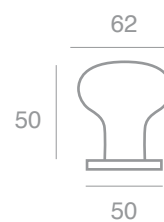

## PUN55



PUN5560

- IT** Pomolo con rosetta Ø 50
- EN** Knob with rose Ø 50
- ES** Pomo con roseta Ø 50
- RU** Кноб на розетке Ø 50



### Technical Informations



**PMA70**

PMA7060

- IT** Pomolo con rosetta Ø 50
- EN** Knob with rose Ø 50
- ES** Pomo con roseta Ø 50
- RU** Кноб на розетке Ø 50

**Technical Informations****PSQ55**

PSQ5554

- IT** Pomolo con rosetta quadra 50x50
- EN** Knob with square rose 50x50
- ES** Pomo con roseta cuadrada mm 50x50
- RU** Кноб на квадратной розетке 50x50

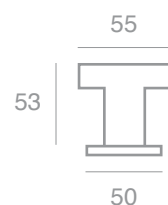
**Technical Informations****PT050**

PT05060

- IT** Pomolo con rosetta Ø 50
- EN** Knob with rose Ø 50
- ES** Pomo con roseta Ø 50
- RU** Кноб на розетке Ø 50

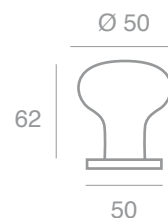
**Technical Informations**

## PUN5567



PUN5567

- IT** Pomolo con rosetta Ø 70 viti in vista
- EN** Knob with rose Ø 70 exposed fixing
- ES** Pomo con roseta Ø 70 con tornillos visibles
- RU** Кноб на розетке Ø 70 с видимой фиксацией



### Technical Informations

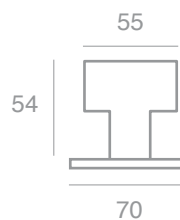

## PUN5568



PUN5568

- IT** Pomolo con rosetta Ø 70 coprivite
- EN** Knob with rose Ø 70 concealed fixing
- ES** Pomo con roseta Ø 70 sin tornillos visibles
- RU** Кноб на розетке Ø 70 со скрытой фиксацией



### Technical Informations

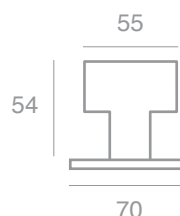

## PMI4583



PMI4583

- IT** Pomolo con rosetta ovale viti in vista
- EN** Knob with oval rose exposed fixing
- ES** Pomo con roseta ovalada con tornillos visibles
- RU** Кноб на овальной розетке с видимой фиксацией



### Technical Informations

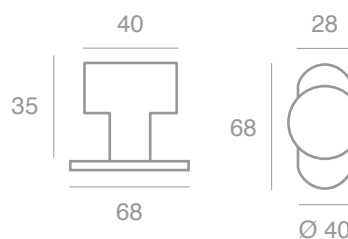

**PG10****PG108194P**

- IT** Guarnitura pomolo con rosette e bocchette Ø 50 foro chiave
- EN** Pair of knob with roses and escutcheons Ø 50 key hole
- ES** Juego de pomos con rosetas Ø 50 y bocallaves gorjas
- RU** Пара кнобов на розетке и с накладкой Ø 50 с отверстием под кабинетный ключ

**PG1050**

- IT** Bilancino pomolo
- EN** Pair of knobs
- ES** Juego de pomos sin rosetas
- RU** пара кнобов

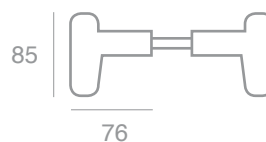
**Technical Informations****PMI45****PMI458194P**

- IT** Guarnitura pomolo con rosette e bocchette Ø 50 foro chiave
- EN** Pair of knob with roses and escutcheons Ø 50 key hole
- ES** Juego de pomos con rosetas Ø 50 y bocallaves gorjas
- RU** Пара кнобов на розетке и с накладкой Ø 50 с отверстием под кабинетный ключ

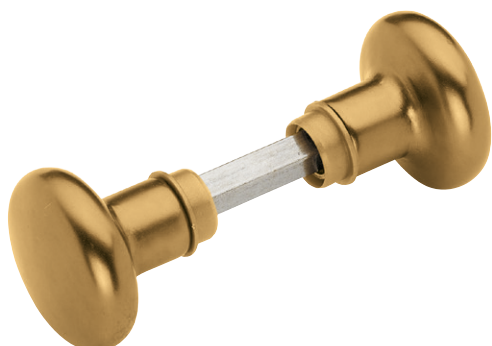
**PMI4550**

- IT** Bilancino pomolo
- EN** Pair of knobs
- ES** Juego de pomos sin rosetas
- RU** пара кнобов

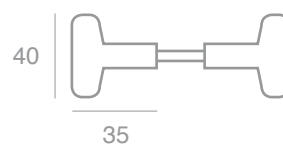
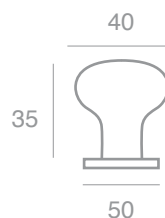
**Technical Informations**

## PBC60

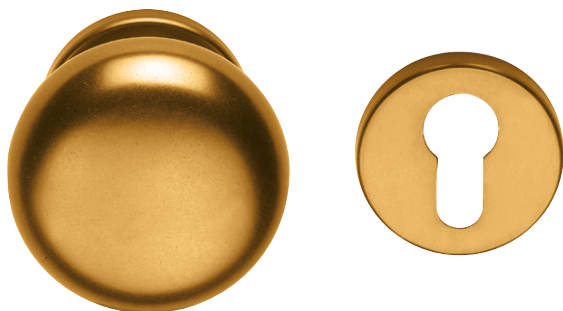

PBC608194Y

**IT** Guarnitura pomolo con rosette e bocchette Ø 50 foro Yale

**EN** Pair of knobs with roses and escutcheons Ø 50 PZ hole

**ES** Juego de pomos con rosetas Ø 50 y bocallaves Yale

**RU** Пара кнобов на розетке и с накладкой Ø 50 с отверстием под цилиндр



PBC6050

**IT** Bilancino pomolo

**EN** Pair of knobs

**ES** Juego de pomos sin rosetas

**RU** Пара кнобов

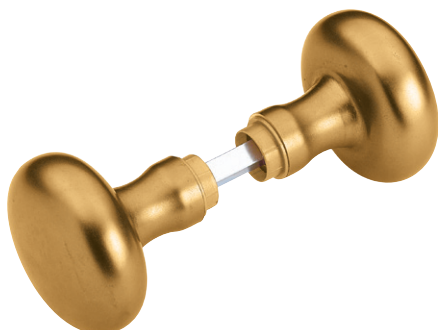

### Technical Informations

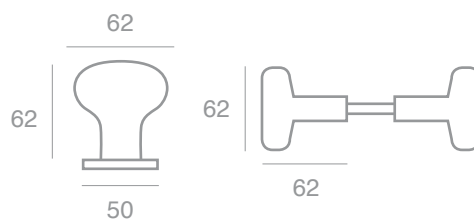

## PTR60



PTR608194Y

**IT** Guarnitura pomolo con rosette e bocchette Ø 50 foro Yale

**EN** Pair of knobs with roses and escutcheons Ø 50 PZ hole

**ES** Juego de pomos con rosetas Ø 50 y bocallaves Yale

**RU** Пара кнобов на розетке и с накладкой Ø 50 с отверстием под цилиндр



PTR6050

**IT** Bilancino pomolo

**EN** Pair of knobs

**ES** Juego de pomos sin rosetas

**RU** Пара кнобов

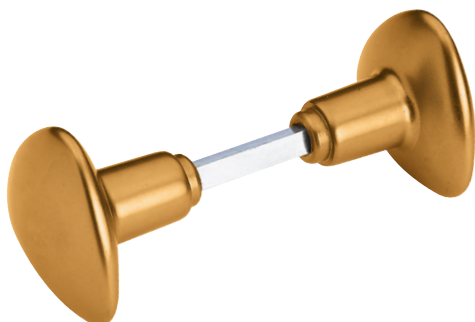
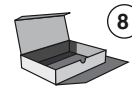

### Technical Informations

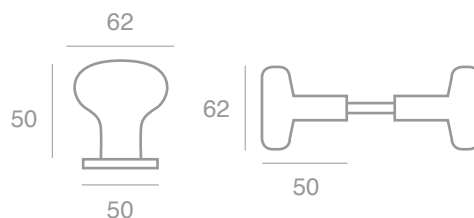

**PEL35**

PEL35

- IT** Bilancino pomolo ovale
- EN** Pair of oval knobs
- ES** Juego de pomos ovalados sin rosetas
- RU** Пара овальных кнобов

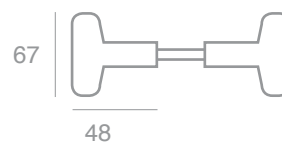
**Technical Informations**







Italian Design Since 1972

**BRIALMA**  
made in italy  
since 1972



# Martelline DK

DK Window  
Handles

Manillas D.K.

para ventanas

Ручки серии

Martelline DK

## Atlanta

A2970M



A2970M

- IT** Martellina DK a 4 scatti con inserto in metallo
- EN** DK handle 4 positions with metallic mechanism
- ES** DK manilla para ventanas 4 posiciones
- RU** Оконная ручка 4 позиции с металлическим механизмом



**Technical  
 Informations**

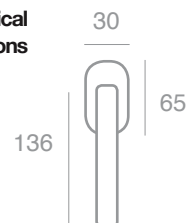

## Adelaide

A57DX70M



A57DX70M

- IT** Martellina DK a 4 scatti con inserto in metallo
- EN** DK handle 4 positions with metallic mechanism
- ES** DK manilla para ventanas 4 posiciones
- RU** Оконная ручка 4 позиции с металлическим механизмом



**Technical  
 Informations**

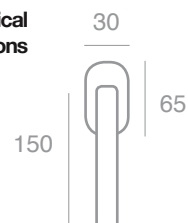

## Acapulco

A6870M



A6870M

- IT** Martellina DK a 4 scatti con inserto in metallo
- EN** DK handle 4 positions with metallic mechanism
- ES** DK manilla para ventanas 4 posiciones
- RU** Оконная ручка 4 позиции с металлическим механизмом



**Technical  
 Informations**

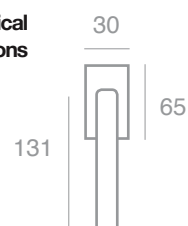

# Bombay

**B6370M**



**B6370M**

- IT** Martellina DK a 4 scatti con inserto in metallo
- EN** DK handle 4 positions with metallic mechanism
- ES** DK manilla para ventanas 4 posiciones
- RU** Оконная ручка 4 позиции с металлическим механизмом



**Technical  
Information**

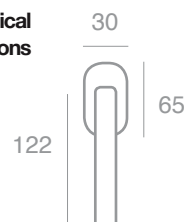

# Manila

**M3870M**



**M3870M**

- IT** Martellina DK a 4 scatti con inserto in metallo
- EN** DK handle 4 positions with metallic mechanism
- ES** DK manilla para ventanas 4 posiciones
- RU** Оконная ручка 4 позиции с металлическим механизмом

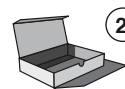

**Technical  
Information**

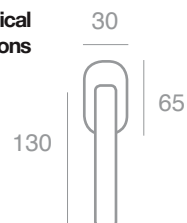

# New York

**N2370M**



**M3370M**

- IT** Martellina DK a 4 scatti con inserto in metallo
- EN** DK handle 4 positions with metallic mechanism
- ES** DK manilla para ventanas 4 posiciones
- RU** Оконная ручка 4 позиции с металлическим механизмом



**Technical  
Information**

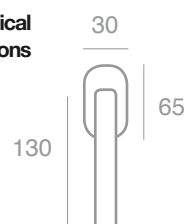

## Astana

A4070  
A4078



A4070

- IT** Martellina DK a 4 scatti
- EN** DK handle 4 positions
- ES** DK manilla para ventanas  
4 posiciones
- RU** Оконная ручка 4 позиции



A4078

- IT** Martellina DK a 8 scatti
- EN** DK handle 8 positions
- ES** DK manilla para ventanas  
8 posiciones
- RU** Оконная ручка 8 позиции

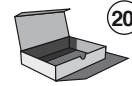

Technical  
Information

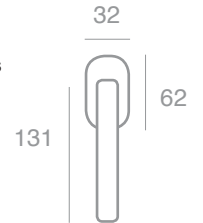

## Nevada

N3470  
N3478



N3470

- IT** Martellina DK a 4 scatti
- EN** DK handle 4 positions
- ES** DK manilla para ventanas  
4 posiciones
- RU** Оконная ручка 4 позиции

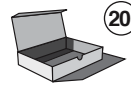

N3478

- IT** Martellina DK a 8 scatti
- EN** DK handle 8 positions
- ES** DK manilla para ventanas  
8 posiciones
- RU** Оконная ручка 8 позиции

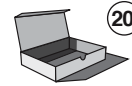

Technical  
Information

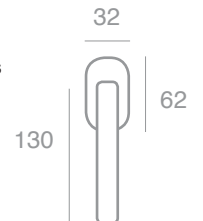

## Dublino

D2070  
D2078



D2070

- IT** Martellina DK a 4 scatti
- EN** DK handle 4 positions
- ES** DK manilla para ventanas  
4 posiciones
- RU** Оконная ручка 4 позиции

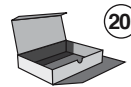

D2078

- IT** Martellina DK a 8 scatti
- EN** DK handle 8 positions
- ES** DK manilla para ventanas  
8 posiciones
- RU** Оконная ручка 8 позиции



Technical  
Information

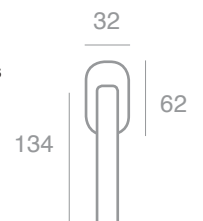

# Haiti

H1570  
 H1578



H1570

- IT** Martellina DK a 4 scatti
- EN** DK handle 4 positions
- ES** DK manilla para ventanas  
4 posiciones
- RU** Оконная ручка 4 позиции

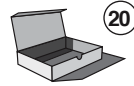

H1578

- IT** Martellina DK a 8 scatti
- EN** DK handle 8 positions
- ES** DK manilla para ventanas  
8 posiciones
- RU** Оконная ручка 8 позиции

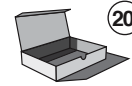

Technical  
 Informations

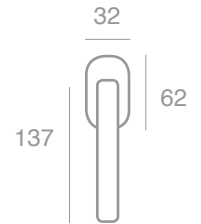

# Kiev

K8170  
 K8178



K8170

- IT** Martellina DK a 4 scatti
- EN** DK handle 4 positions
- ES** DK manilla para ventanas  
4 posiciones
- RU** Оконная ручка 4 позиции



K8178

- IT** Martellina DK a 8 scatti
- EN** DK handle 8 positions
- ES** DK manilla para ventanas  
8 posiciones
- RU** Оконная ручка 8 позиции

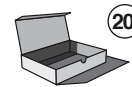

Technical  
 Informations

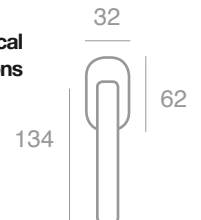

# Seattle

S4470  
 S4478



S4470

- IT** Martellina DK a 4 scatti
- EN** DK handle 4 positions
- ES** DK manilla para ventanas  
4 posiciones
- RU** Оконная ручка 4 позиции



S4478

- IT** Martellina DK a 8 scatti
- EN** DK handle 8 positions
- ES** DK manilla para ventanas  
8 posiciones
- RU** Оконная ручка 8 позиции



Technical  
 Informations

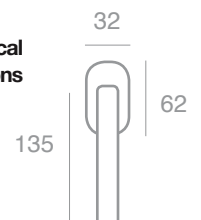

## Texas

T4870  
T4878



T4870

- IT** Martellina DK a 4 scatti
- EN** DK handle 4 positions
- ES** DK manilla para ventanas 4 posiciones
- RU** Оконная ручка 4 позиции



T4878

- IT** Martellina DK a 8 scatti
- EN** DK handle 8 positions
- ES** DK manilla para ventanas 8 posiciones
- RU** Оконная ручка 8 позиции

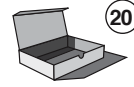

Technical  
Informations

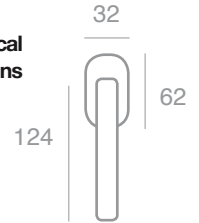

## Mars

M3370M



M3370M

- IT** Martellina DK a 4 scatti con inserto in metallo
- EN** DK handle 4 positions with metallic mechanism
- ES** DK manilla para ventanas 4 posiciones
- RU** Оконная ручка 4 позиции с металлическим механизмом

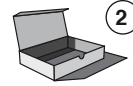

Technical  
Informations

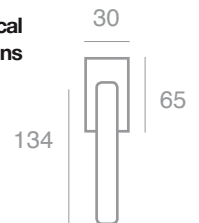

## Mercury

M4670M



M4670M

- IT** Martellina DK a 4 scatti con inserto in metallo
- EN** DK handle 4 positions with metallic mechanism
- ES** DK manilla para ventanas 4 posiciones
- RU** Оконная ручка 4 позиции с металлическим механизмом



Technical  
Informations

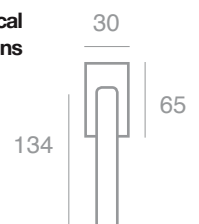

# Uranus

U6670DXM  
U6670SXM



## U6670DXM

- IT** Martellina DK destra a 4 scatti
- EN** DK right handle 4 positions
- ES** DK manilla para ventanas izquierda 4 posiciones
- RU** Оконная ручка 4 позиции



## U6670SXM

- IT** Martellina DK sinistra a 4 scatti
- EN** DK left handle 4 positions
- ES** DK manilla para ventanas derecha 4 posiciones
- RU** Оконная ручка правое 4 позиции



### Technical Informations

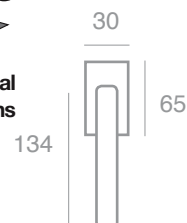

# Jupiter

J7170M



## J7170M

- IT** Martellina DK a 4 scatti con inserto in metallo
- EN** DK handle 4 positions with metallic mechanism
- ES** DK manilla para ventanas 4 posiciones
- RU** Оконная ручка 4 позиции с металлическим механизмом



### Technical Informations

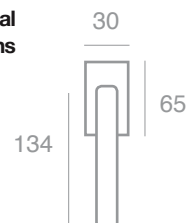

# Saturn

S7770M



## S7770M

- IT** Martellina DK a 4 scatti con inserto in metallo
- EN** DK handle 4 positions with metallic mechanism
- ES** DK manilla para ventanas 4 posiciones
- RU** Оконная ручка 4 позиции с металлическим механизмом



### Technical Informations

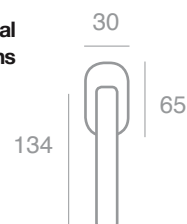

# Neptune

**N8870M**



**N8870M**

- IT** Martellina DK a 4 scatti con inserto in metallo
- EN** DK handle 4 positions with metallic mechanism
- ES** DK manilla para ventanas 4 posiciones
- RU** Оконная ручка 4 позиции с металлическим механизмом

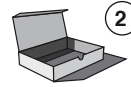

**Technical Informations**

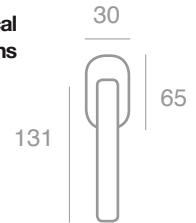

# Quadra

**Q2470M**



**Q2470M**

- IT** Martellina DK a 4 scatti con inserto in metallo
- EN** DK handle 4 positions with metallic mechanism
- ES** DK manilla para ventanas 4 posiciones
- RU** Оконная ручка 4 позиции с металлическим механизмом



**Technical Informations**

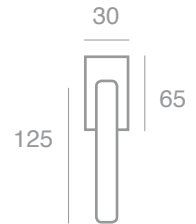

# Detroit

**D54DX70**  
**D54SX70**



**D54DX70**

- IT** Martellina DK a 4 scatti
- EN** DK right handle 4 positions
- ES** DK manilla para ventanas izquierda 4 posiciones
- RU** Оконная ручка 4 позиции



**D54SX70**

- IT** Martellina DK sinistra a 4 scatti
- EN** DK left handle 4 positions
- ES** DK manilla para ventanas derecha 4 posiciones
- RU** Оконная ручка правое 4 позиции



**Technical Informations**

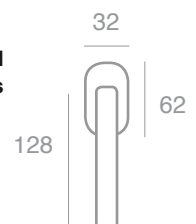



# Lisbona

L7470  
 L7478



L7470

- IT** Martellina DK destra a 4 scatti
- EN** DK right handle 4 positions
- ES** DK manilla para ventanas izquierda 4 posiciones
- RU** Оконная ручка 4 позиции

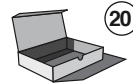

L7478

- IT** Martellina DK sinistra a 8 scatti
- EN** DK left handle 8 positions
- ES** DK manilla para ventanas derecha 8 posiciones
- RU** Оконная ручка правое 8 позиции

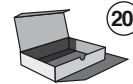

Technical  
 Informations

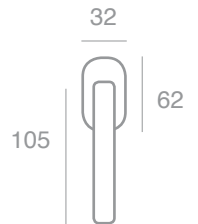

# Santiago

S5070  
 S5078



S5070

- IT** Martellina DK destra a 4 scatti
- EN** DK right handle 4 positions
- ES** DK manilla para ventanas izquierda 4 posiciones
- RU** Оконная ручка 4 позиции

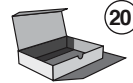

S5078

- IT** Martellina DK sinistra a 8 scatti
- EN** DK left handle 8 positions
- ES** DK manilla para ventanas derecha 8 posiciones
- RU** Оконная ручка правое 8 позиции



Technical  
 Informations

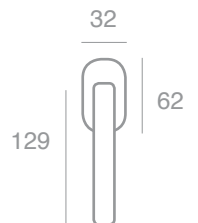

# Milano

M41DX70  
 M41SX70  
 M41DX78  
 M41SX78



M41DX70

- IT** Martellina DK destra a 4 scatti
- EN** DK right handle 4 positions
- ES** DK manilla para ventanas izquierda 4 posiciones
- RU** Оконная ручка 4 позиции



M41SX70

- IT** Martellina DK sinistra a 4 scatti
- EN** DK left handle 4 positions
- ES** DK manilla para ventanas derecha 4 posiciones
- RU** Оконная ручка правое 4 позиции



Technical  
 Informations

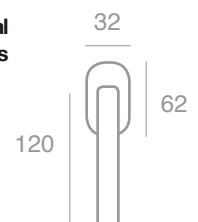

# Glasgow

G3070  
G3078



G3070

- IT** Martellina DK a 4 scatti
- EN** DK handle 4 positions
- ES** DK manilla para ventanas 4 posiciones
- RU** Оконная ручка 4 позиции

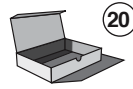

G3078

- IT** Martellina DK a 8 scatti
- EN** DK handle 8 positions
- ES** DK manilla para ventanas 8 posiciones
- RU** Оконная ручка 8 позиции

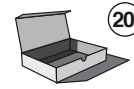

Technical  
Informations

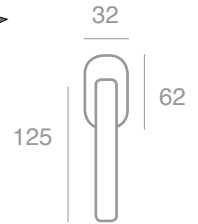

# Kiruna

K3270  
K3278



K3270

- IT** Martellina DK a 4 scatti
- EN** DK handle 4 positions
- ES** DK manilla para ventanas 4 posiciones
- RU** Оконная ручка 4 позиции



K3278

- IT** Martellina DK a 8 scatti
- EN** DK handle 8 positions
- ES** DK manilla para ventanas 8 posiciones
- RU** Оконная ручка 8 позиции

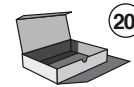

Technical  
Informations

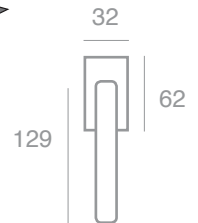

# Roma

R1970  
R1978



R1970

- IT** Martellina DK a 4 scatti
- EN** DK handle 4 positions
- ES** DK manilla para ventanas 4 posiciones
- RU** Оконная ручка 4 позиции



R1978

- IT** Martellina DK a 8 scatti
- EN** DK handle 8 positions
- ES** DK manilla para ventanas 8 posiciones
- RU** Оконная ручка 8 позиции



Technical  
Informations

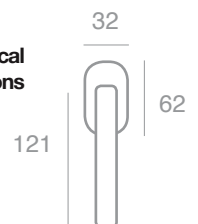

## Trio

T0370  
T0378



T0370

- IT** Martellina DK a 4 scatti
- EN** DK handle 4 positions
- ES** DK manilla para ventanas 4 posiciones
- RU** Оконная ручка 4 позиции



T0378

- IT** Martellina DK a 8 scatti
- EN** DK handle 8 positions
- ES** DK manilla para ventanas 8 posiciones
- RU** Оконная ручка 8 позиции

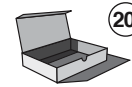

Technical  
 Informations

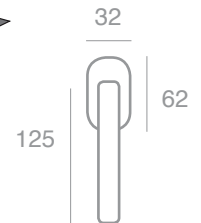

## Corus

C1570  
C1578



C1570

- IT** Martellina DK a 4 scatti
- EN** DK handle 4 positions
- ES** DK manilla para ventanas 4 posiciones
- RU** Оконная ручка 4 позиции



C1578

- IT** Martellina DK a 8 scatti
- EN** DK handle 8 positions
- ES** DK manilla para ventanas 8 posiciones
- RU** Оконная ручка 8 позиции



Technical  
 Informations

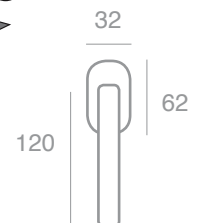

## Venus

V2170  
V2178



V2170

- IT** Martellina DK a 4 scatti
- EN** DK handle 4 positions
- ES** DK manilla para ventanas 4 posiciones
- RU** Оконная ручка 4 позиции



V2178

- IT** Martellina DK a 8 scatti
- EN** DK handle 8 positions
- ES** DK manilla para ventanas 8 posiciones
- RU** Оконная ручка 8 позиции



Technical  
 Informations

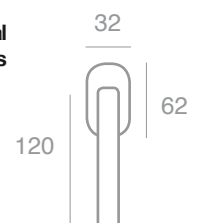

# Londra

**L1870**

**Finiture disponibili**

**F1 - F1 satinato**

Available finishing

F1 - satinato F1



**L1870**

**IT**

**Martellina DK a 4 scatti**

**EN**

DK handle 4 positions

**ES**

DK manilla para ventanas 4 posiciones

**RU**

Оконная ручка 4 позиции

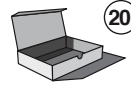

**Technical  
 Informations**

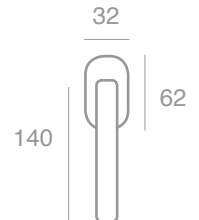

# Atene

**A1470**

**A1478**



**A1470**

**IT**

**Martellina DK a 4 scatti**

**EN**

DK handle 4 positions

**ES**

DK manilla para ventanas  
 4 posiciones

**RU**

Оконная ручка 4 позиции



**A1478**

**IT**

**Martellina DK a 8 scatti**

**EN**

DK handle 8 positions

**ES**

DK manilla para ventanas  
 8 posiciones

**RU**

Оконная ручка 8 позиции

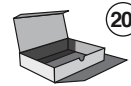

**Technical  
 Informations**

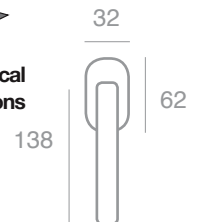

# Firenze

**F2270**

**F2278**



**F2270**

**IT**

**Martellina DK a 4 scatti**

**EN**

DK handle 4 positions

**ES**

DK manilla para ventanas  
 4 posiciones

**RU**

Оконная ручка 4 позиции



**F2278**

**IT**

**Martellina DK a 8 scatti**

**EN**

DK handle 8 positions

**ES**

DK manilla para ventanas  
 8 posiciones

**RU**

Оконная ручка 8 позиции



**Technical  
 Informations**

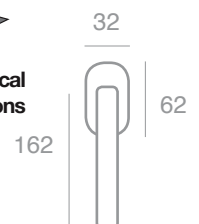

# Madrid

M1670  
 M1678



## M1670

- IT** Martellina DK a 4 scatti
- EN** DK handle 4 positions
- ES** DK manilla para ventanas 4 posiciones
- RU** Оконная ручка 4 позиции

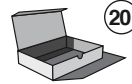

## M1678

- IT** Martellina DK a 8 scatti
- EN** DK handle 8 positions
- ES** DK manilla para ventanas 8 posiciones
- RU** Оконная ручка 8 позиции

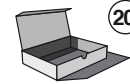

### Technical Informations

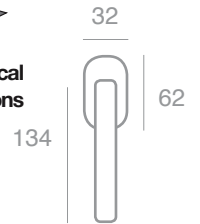

# Everest

EU0670  
 EU0678



## EU0670

- IT** Martellina DK a 4 scatti
- EN** DK handle 4 positions
- ES** DK manilla para ventanas 4 posiciones
- RU** Оконная ручка 4 позиции



## EU0678

- IT** Martellina DK a 8 scatti
- EN** DK handle 8 positions
- ES** DK manilla para ventanas 8 posiciones
- RU** Оконная ручка 8 позиции



### Technical Informations

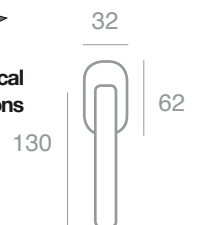

# Zagabria

Z99DX70  
 Z99SX70  
 Z99DX78  
 Z99SX78



## Z99DX70

- IT** Martellina DK destra a 4 scatti
- EN** DK right handle 4 positions
- ES** DK manilla para ventanas izquierda 4 posiciones
- RU** Оконная ручка 4 позиции



## Z99SX70

- IT** Martellina DK sinistra a 4 scatti
- EN** DK left handle 4 positions
- ES** DK manilla para ventanas derecha 4 posiciones
- RU** Оконная ручка правое 4 позиции



### Technical Informations

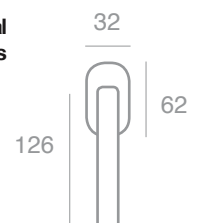

# Bonn

**B2570**  
**B2578**



## B2570

- IT** Martellina DK destra a 4 scatti
- EN** DK right handle 4 positions
- ES** DK manilla para ventanas izquierda 4 posiciones
- RU** Оконная ручка 4 позиции

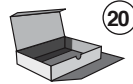

## B2578

- IT** Martellina DK a 8 scatti
- EN** DK handle 8 positions
- ES** DK manilla para ventanas 8 posiciones
- RU** Оконная ручка 8 позиции

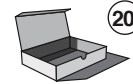

### Technical Informations

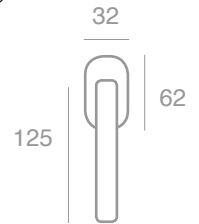

# Toronto

**T1070**  
**T1078**



## T1070

- IT** Martellina DK destra a 4 scatti
- EN** DK right handle 4 positions
- ES** DK manilla para ventanas izquierda 4 posiciones
- RU** Оконная ручка 4 позиции



## T1078

- IT** Martellina DK a 8 scatti
- EN** DK handle 8 positions
- ES** DK manilla para ventanas 8 posiciones
- RU** Оконная ручка 8 позиции

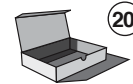

### Technical Informations

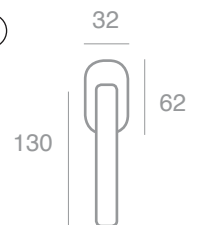

# Sofia

**C11DX70**  
**C11SX70**  
**C11DX78**  
**C11SX78**



## C11DX70

- IT** Martellina DK destra a 4 scatti
- EN** DK right handle 4 positions
- ES** DK manilla para ventanas izquierda 4 posiciones
- RU** Оконная ручка 4 позиции



## C11SX70

- IT** Martellina DK sinistra a 4 scatti
- EN** DK left handle 4 positions
- ES** DK manilla para ventanas derecha 4 posiciones
- RU** Оконная ручка правое 4 позиции



### Technical Informations

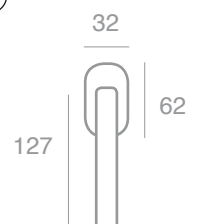

## Ginevra

GB0170  
 GB0178



**GB0170**

- IT** Martellina DK a 4 scatti
- EN** DK handle 4 positions
- ES** DK manilla para ventanas  
4 posiciones
- RU** Оконная ручка 4 позиции



**GB0178**

- IT** Martellina DK a 8 scatti
- EN** DK handle 8 positions
- ES** DK manilla para ventanas  
8 posiciones
- RU** Оконная ручка 8 позиции



**Technical  
 Informations**

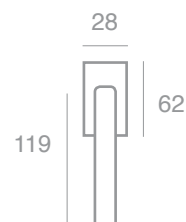

## Melbourne

M1270  
 M1278



**M1270**

- IT** Martellina DK a 4 scatti
- EN** DK handle 4 positions
- ES** DK manilla para ventanas  
4 posiciones
- RU** Оконная ручка 4 позиции



**M1278**

- IT** Martellina DK a 8 scatti
- EN** DK handle 8 positions
- ES** DK manilla para ventanas  
8 posiciones
- RU** Оконная ручка 8 позиции



**Technical  
 Informations**

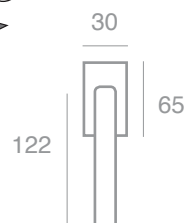

## Japan

J0570  
 J0578



**J0570**

- IT** Martellina DK a 4 scatti
- EN** DK handle 4 positions
- ES** DK manilla para ventanas  
4 posiciones
- RU** Оконная ручка 4 позиции



**J0578**

- IT** Martellina DK a 8 scatti
- EN** DK handle 8 positions
- ES** DK manilla para ventanas  
8 posiciones
- RU** Оконная ручка 8 позиции



**Technical  
 Informations**

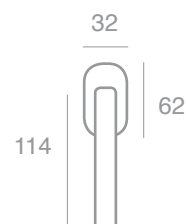

## Sydney

SS0270  
SS0278



### SS0270

- IT** Martellina DK a 4 scatti
- EN** DK handle 4 positions
- ES** DK manilla para ventanas  
4 posiciones
- RU** Оконная ручка 4 позиции



### SS0278

- IT** Martellina DK a 8 scatti
- EN** DK handle 8 positions
- ES** DK manilla para ventanas  
8 posiciones
- RU** Оконная ручка 8 позиции

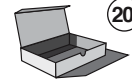

Technical  
Informations

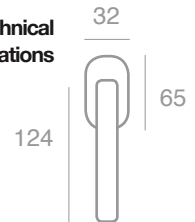

## Venezia

VN0770  
VN0778



### VN0770

- IT** Martellina DK a 4 scatti
- EN** DK handle 4 positions
- ES** DK manilla para ventanas  
4 posiciones
- RU** Оконная ручка 4 позиции



### VN0778

- IT** Martellina DK a 8 scatti
- EN** DK handle 8 positions
- ES** DK manilla para ventanas  
8 posiciones
- RU** Оконная ручка 8 позиции



Technical  
Informations

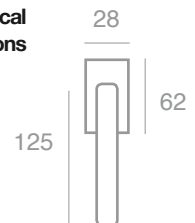

## Florida

F1370  
F1378



### F1370

- IT** Martellina DK a 4 scatti
- EN** DK handle 4 positions
- ES** DK manilla para ventanas  
4 posiciones
- RU** Оконная ручка 4 позиции



### F1378

- IT** Martellina DK a 8 scatti
- EN** DK handle 8 positions
- ES** DK manilla para ventanas  
8 posiciones
- RU** Оконная ручка 8 позиции



Technical  
Informations

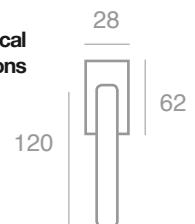



Usa

UN0470  
UN0478



UN0470

- IT** Martellina DK a 4 scatti
- EN** DK handle 4 positions
- ES** DK manilla para ventanas  
4 posiciones
- RU** Оконная ручка 4 позиции



UN0478

- IT** Martellina DK a 8 scatti
- EN** DK handle 8 positions
- ES** DK manilla para ventanas  
8 posiciones
- RU** Оконная ручка 8 позиции

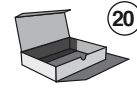

Technical  
Information

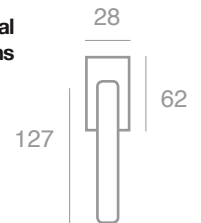

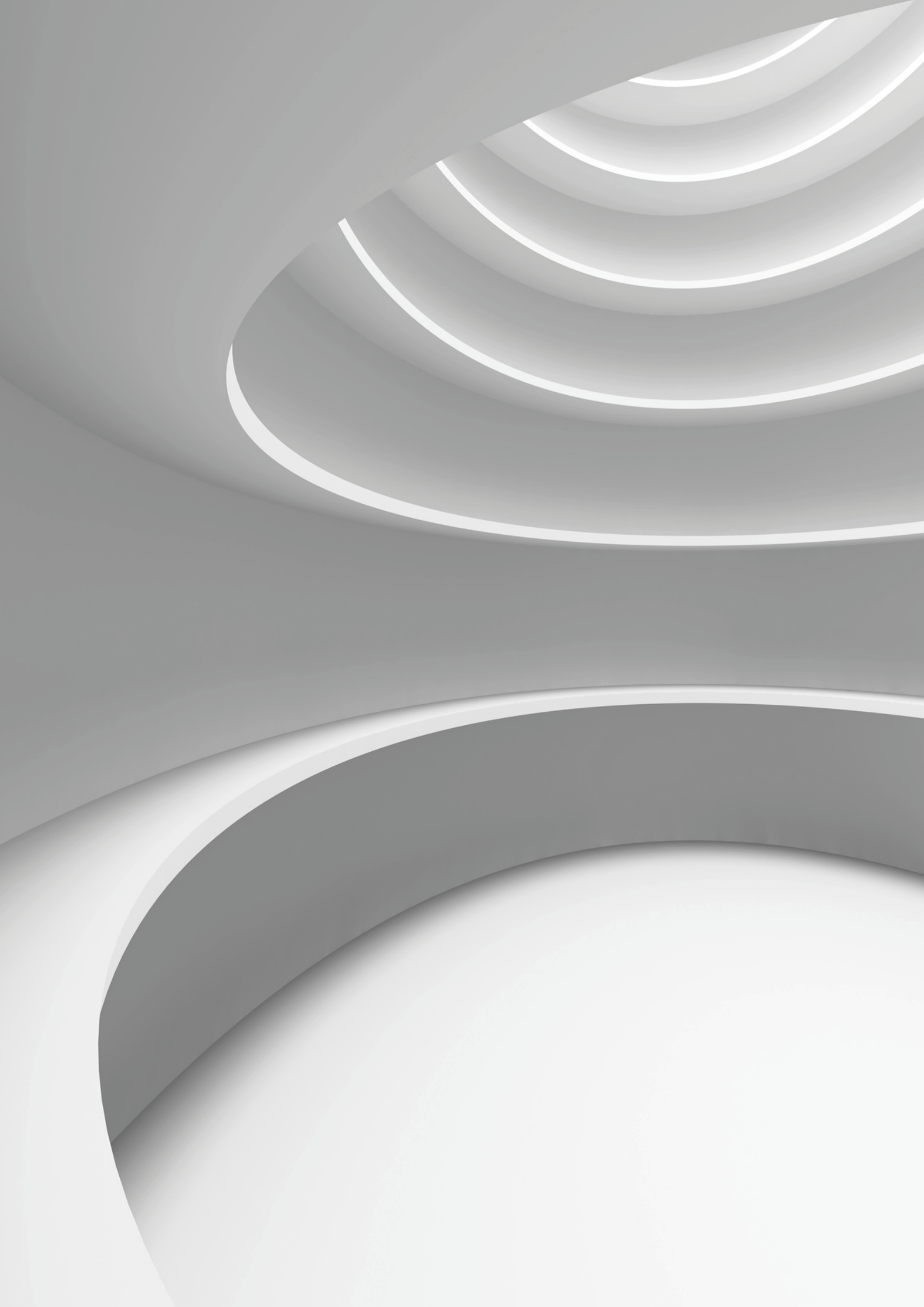

Italian Design Since 1972

**BRIALMA**  
made in italy  
since 1972



Cremonesi  
Handles  
Cremonas  
ОКОННЫЕ

# Ginevra

MT1140



MT1140

- IT** Martellina
- EN** Window handle
- ES** Manilla para ventanas
- RU** Оконная ручка

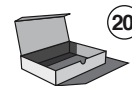

## Technical Informations



# Ginevra

MT1120



MT1120

- IT** Martellina cremonese
- EN** Window handle
- ES** Manilla para ventanas
- RU** Оконная ручка

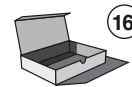

## Technical Informations

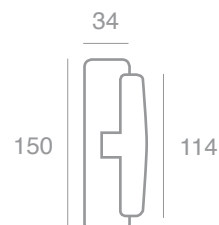

# Ginevra

MT1130



MT1130

- IT** Martellina cremonese
- EN** Window handle
- ES** Manilla para ventanas
- RU** Оконная ручка



## Technical Informations

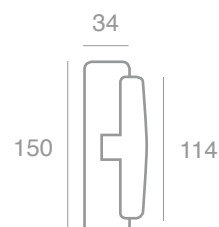

# Sydney

MTS1130



MTS1130

- IT** Martellina cremonese
- EN** Window handle
- ES** Manilla para ventanas
- RU** Оконная ручка



### Technical Informations

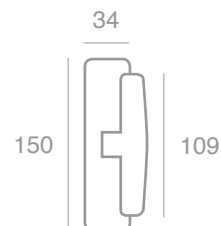

# Melbourne

MTM1120



MTM1120

- IT** Martellina cremonese
- EN** Window handle
- ES** Manilla para ventanas
- RU** Оконная ручка



### Technical Informations

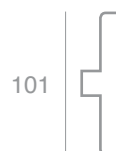

Disponibile sulle seguenti placche  
Available for this plate

# Japan

MTJ1140



MTJ1140

- IT** Martellina
- EN** Window handle
- ES** Manilla para ventanas
- RU** Оконная ручка



### Technical Informations

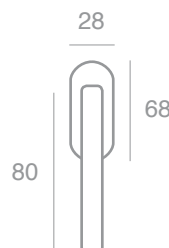

## Movimenti per cremonesi | Mechanism for window handle | Movimientos para Cremonese | движения для Оконные ручки

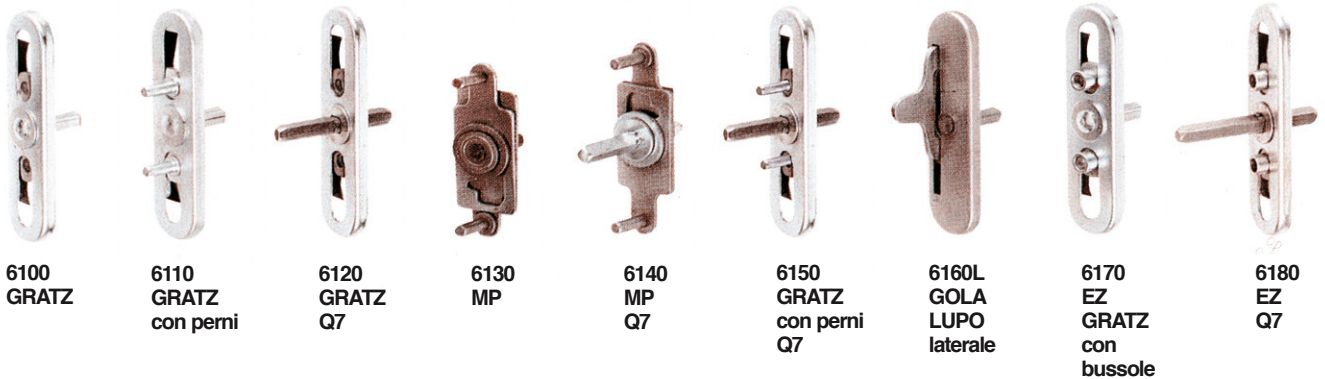

## Codici per cremonesi | Codes for window handle | Códigos para Cremonese | Коды для Оконные ручки

codice martellina window handle código martellina код Оконные ручки	codice gioco mechanism code código mecanismo Код игры	codice prodotto finito code of final product código de producto terminado код продукта законченный
MT1120		MT1120
MT1120	6100	MT1121
MT1120	6110	MT1122
MT1120	6120	MT1123
MT1120	6130	MT1124
MT1120	6140	MT1125
MT1120	6150	MT1126
MT1120	6160	MT1127C
MT1120	6160L	MT1127L
MT1120	6170	MT1128
MT1120	6180	MT1129
MT1130	•	MT1130
MT1130	6100	MT1131
MT1130	6110	MT1132
MT1130	6120	MT1133
MT1130	6130	MT1134
MT1130	6140	MT1135
MT1130	6150	MT1136
MT1130	6160	MT1137C
MT1130	6160L	MT1137L
MT1130	6170	MT1138
MT1130	6180	MT1139
MT1140	•	MT1140

Esempio: cremonesi e martelline  
Example: window handles  
Ejemplo: Cremonese y martillos  
пример: Оконные ручки



MT1128F4

maniglia	codice gioco	finitura
handle	mechanism code	finishing
manillas	código mecanismo	acabado
Ручка	Код игры	доступные

MT1120

6170

F4



### Per le martelline tipo MTS e MTM vale la stessa tabella

The same rule is valid for window handle type MTM and MTS

Para martillos tipo MTS y MTM es la misma mesa

для Оконные ручки тип MTS и MTM это же таблица







Italian Design Since 1972

**BRIALMA**  
made in italy  
since 1972



# Accessori Porte Blindate

Armored Door Accessories  
Accesorios para Puertas  
Acorazadas  
Аксессуары для дверей

## PMA50



### PMA5026Y

- IT** Coppia pomolo con placca tipo 2600 foro Yale
- EN** Pair of knobs with plate type 2600 PZ hole
- ES** Juego de pomos con placa 2600 bocallaves Yale
- RU** пара кнобов на планке 2600 типа с отверстием под цилиндра



#### Technical Informations

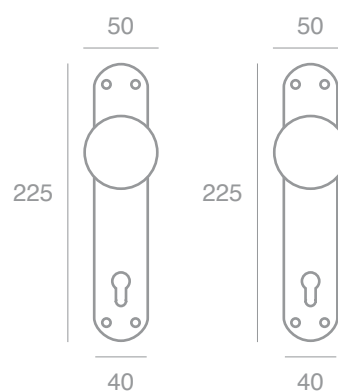

### PMA5050

- IT** Bilancino pomolo
- EN** Pair of knobs 2600 PZ hole
- ES** Juego de pomos ovalados
- RU** пара кнобов



#### Technical Informations

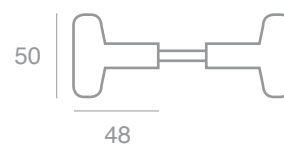

## PBC6066M12

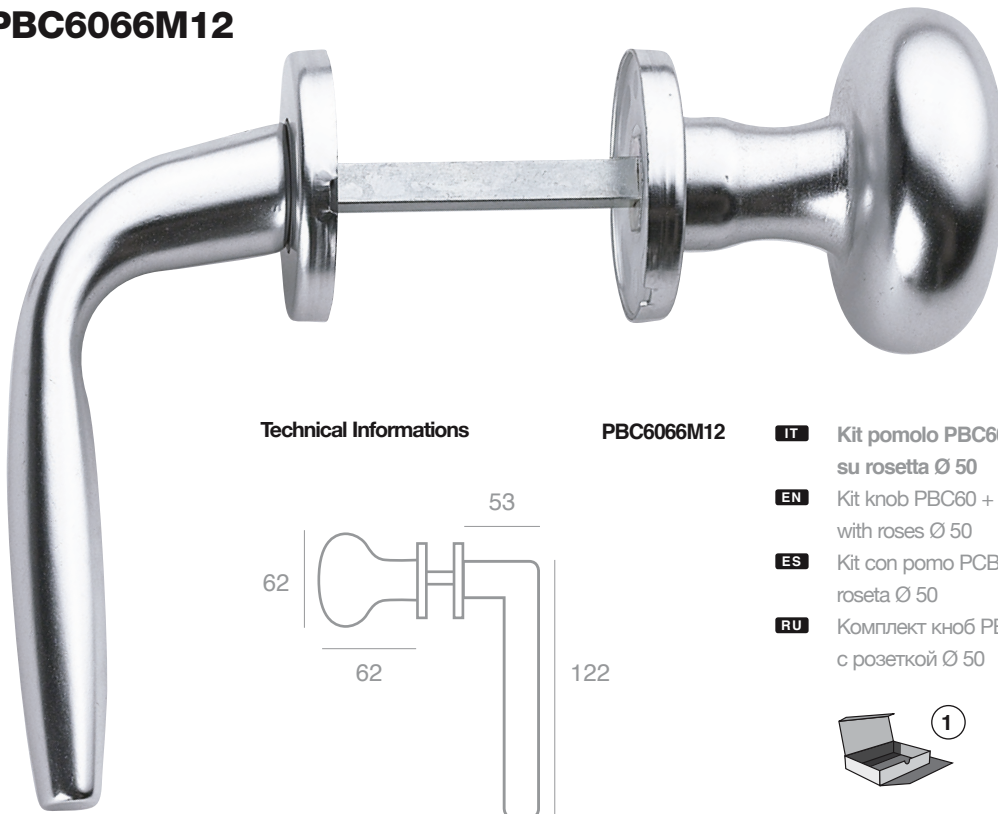

### Technical Informations

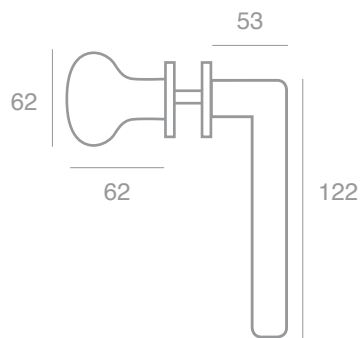

### PBC6066M12

- IT** Kit pomolo PBC60 + maniglia M12 su rosetta Ø 50
- EN** Kit knob PBC60 + handle M12 with roses Ø 50
- ES** Kit con pomolo PCB60 y manilla M12, roseta Ø 50
- RU** Комплект knob PBC60 + ручка M12 с розеткой Ø 50



## 608563T10262FY



### 608563T10262FY

- IT** Kit maniglione 6085 con maniglia T10 su placca 2600 2 fori Yale
- EN** Pull handle 6085 + handle G30 on plate type 3500 3 screw holes, with stainless steel underplate, PZ hole
- ES** Kit manijas grande 6085 con manija sobre placa 2 bocallaves Yale
- RU** Комплект стационарной дверной ручки 6085 с нажимной ручкой T10 на планке 2600 с двумя отверстиями для крепления и фрезировкой под евроцилиндр



### Technical Informations

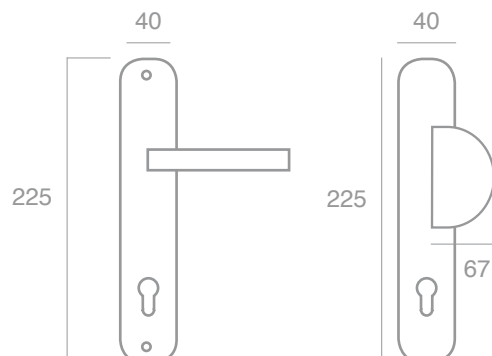

## BLI1000

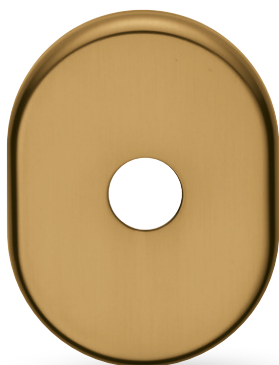

### Technical Informations



BLI1000

- IT** Rosetta ovale foro  $\varnothing$  16
- EN** Oval rose with hole  $\varnothing$  16
- ES** Roseta ovalada, agujero  $\varnothing$  16
- RU** Овальная розетка с отверстием  $\varnothing$  16



## BLI1010



### Technical Informations

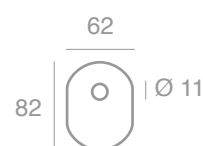

BLI1010

- IT** Rosetta ovale foro decentrato
- EN** Oval rose with decentralized hole
- ES** Roseta ovalada, agujero descentrado
- RU** Овальная розетка с децентрализованным отверстием



## BLI1020



### Technical Informations



BLI1020

- IT** Bocchetta ovale foro Yale
- EN** Oval escutcheon PZ hole
- ES** Bocallave ovalada Yale
- RU** Овальная накладка с отверстием для цилиндра



## BLI1030

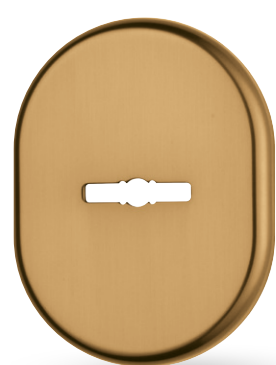

### Technical Informations

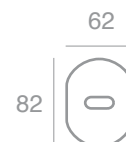

BLI1030

- IT** Bocchetta ovale foro doppia mappa
- EN** Oval escutcheon double ward hole
- ES** Bocallave ovalada para puertas acorazadas
- RU** Овальная розетка с отверстием для сувальдного ключа



## BLI1040



### Technical Informations



- BLI1040**
- IT** Rosetta ovale per limitatore
  - EN** Oval rose with limiting device hole
  - ES** Bocallave ovalada para limitador de abertura
  - RU** Овальная розетка с отверстием для ограничителя

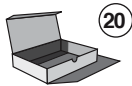

## BLI1050

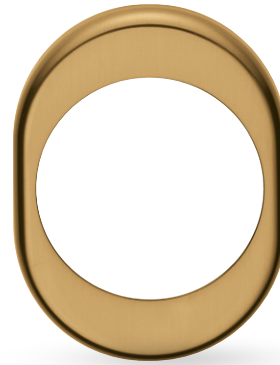

### Technical Informations



- BLI1050**
- IT** Rosetta ovale foro Ø 50
  - EN** Oval rose with hole Ø 50
  - ES** Roseta ovalada, agujero Ø 50
  - RU** Овальная розетка с отверстием Ø 50



## BLI1060



### Technical Informations



- BLI1060**
- IT** Cover Ø 50
  - EN** Cover Ø 50
  - ES** Cobertura Ø 50
  - RU** Накладка Ø 50



- BLI1066**
- IT** Cover Ø 46
  - EN** Cover Ø 46
  - ES** Cobertura Ø 46
  - RU** Накладка Ø 46



## PF35F4



### Technical Informations

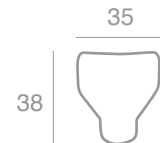

- PF35F4**
- IT** Pomolo F. 8 per cilindro
  - EN** Knob Ø.8 for cylinder
  - ES** Pomo agujero 8 para cilindro
  - RU** Рукоятка для цилиндра отверстие 8 мм



## P3610

### Technical Informations

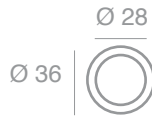

- P3610**
- IT** Pomolo per limitatore scorrevole
  - EN** Sliding opening limiting device knob
  - ES** Pomolo por limitador corredizo
  - RU** Кноб для ограничителя открывания сдвижного типа

## PST38

### Technical Informations

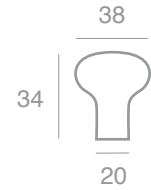

- PST38**
- IT** Nottolino Q.8 per limitatore scorrevole
  - EN** Sliding opening limiting device knob
  - ES** Pestillo cuadrado 8 para limitador de deslizamiento
  - RU** Рукоятка для сдвижного ограничителя квадрат 8 мм

## 4320

### Technical Informations



- 4320**
- IT** Nottolino Q.8 per limitatore
  - EN** Little handle square 8 for limiting
  - ES** Muletilla para cuadradillo 8 mm por limitador de abertura
  - RU** Ручка поворотная квадрат 8 мм для ограничителя

## 4300

### Technical Informations



- 4300**
- IT** Nottolino Q.8 per limitatore
  - EN** Little handle square 8 for limiting
  - ES** Muletilla para cuadradillo 8 mm por limitador de abertura
  - RU** Ручка поворотная квадрат 8 мм для ограничителя

## PBC 6066S02



- PBC6066S02**
- IT** Kit pomolo PBC60 + maniglia S02 su rosetta Ø 50
  - EN** Kit knob PBC60 + handle S02 with roses Ø 50
  - ES** Kit con pomolo PCB60 y manilla S02, roseta Ø 50
  - RU** Комплект кноб PBC60 + ручка S02 с розеткой Ø 50

### Technical Informations

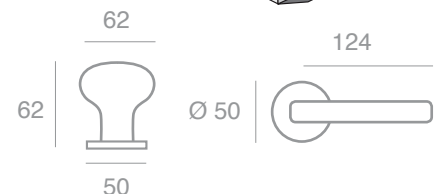

## RPI84X60Y



### Technical Informations

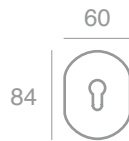

RPI84X60Y

- IT** Rosetta piana foro Yale
- EN** Flat rose PZ hole
- ES** Bocallave plana, Yale
- RU** Плоская розетка с отверстием для цилиндра

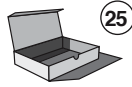

## RPI84X60D



### Technical Informations



RPI84X60D

- IT** Rosetta piana foro doppia mappa
- EN** Flat rose double ward hole
- ES** Bocallave plana para puertas acorazadas
- RU** Плоская розетка с отверстием для сувальдного ключа

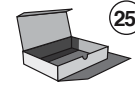

## RPI84X60L



### Technical Informations



RPI84X60L

- IT** Rosetta piana foro per limitatore
- EN** Flat rose with limiting device hole
- ES** Roseta plana con agujero por limitador de abertura
- RU** Плоская розетка с отверстием для ограничителя



## RPI84X60F46



### Technical Informations



RPI84X60L

- IT** Rosetta piana foro Ø.46
- EN** Flat rose with hole Ø.46
- ES** Roseta plana agujero Ø.46
- RU** Плоская розета с отверстием Ø.46



## BLI1000 OL



Technical  
 Informations



BLI1000 OL

- IT** Rosetta ovale foro  $\varnothing$  16
- EN** Oval rose with hole  $\varnothing$  16
- ES** Roseta ovalada, agujero  $\varnothing$  16
- RU** Овальная розетка с отверстием  $\varnothing$  16



## BLI1010 OL



Technical  
 Informations

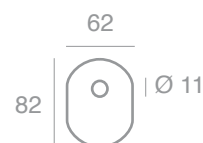

BLI1010 OL

- IT** Rosetta ovale foro decentrato
- EN** Oval rose with decentralized hole
- ES** Roseta ovalada, agujero descentrado
- RU** Овальная розетка с децентрализованным отверстием



## BLI1020 OL



Technical  
 Informations



BLI1020 OL

- IT** Bocchetta ovale foro Yale
- EN** Oval escutcheon PZ hole
- ES** Bocallave ovalada Yale
- RU** Овальная накладка с отверстием для цилиндра



## BLI1030 OL



Technical  
 Informations



BLI1030 OL

- IT** Bocchetta ovale foro doppia mappa
- EN** Oval escutcheon double ward hole
- ES** Bocallave ovalada para puertas acorazadas
- RU** Овальная розетка с отверстием для сувальдного ключа





## BLI1040 OL



### Technical Informations



BLI1040 OL

- IT** Rosetta ovale per limitatore
- EN** Oval rose with limiting device hole
- ES** Bocallave ovalada para limitador de abertura
- RU** Овальная розетка с отверстием для ограничителя

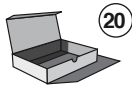

## BLI1050 OL



### Technical Informations



BLI1050 OL

- IT** Rosetta ovale foro Ø 50
- EN** Oval rose with hole Ø 50
- ES** Roseta ovalada, agujero Ø 50
- RU** Овальная розетка с отверстием Ø 50

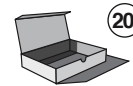

## BLI1060 OL



BLI1060 OL

- IT** Cover Ø 50
- EN** Cover Ø 50
- ES** Cobertura Ø 50
- RU** Накладка Ø 50



BLI1066 OL

- IT** Cover Ø 46
- EN** Cover Ø 46
- ES** Cobertura Ø 46
- RU** Накладка Ø 46

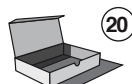

## PF35 OL



### Technical Informations



PF35 OL

- IT** Pomolo F. 8 per cilindro
- EN** Knob Ø.8 for cylinder
- ES** Pomo agujero 8 para cilindro
- RU** Ручейка для цилиндра отверстие 8 мм



### P3610 OL



#### Technical Informations

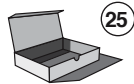

- P3610 OL**
- IT** Pomolo per limitatore scorrevole
  - EN** Sliding opening limiting device knob
  - ES** Pomolo por limitador corredizo
  - RU** Кноб для ограничителя открывания сдвижного типа

### PST38 OL



#### Technical Informations

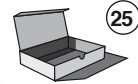
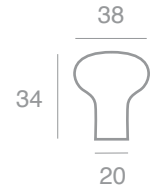

- PST38 OL**
- IT** Nottolino Q.8 per limitatore scorrevole
  - EN** Sliding opening limiting device knob
  - ES** Pestillo cuadrado 8 para limitador de deslizamiento
  - RU** Ручка для сдвижного ограничителя квадрат 8 мм

### 4320 OL



#### Technical Informations



- 4320 OL**
- IT** Nottolino Q.8 per limitatore
  - EN** Little handle square 8 for limiting
  - ES** Muletilla para cuadradillo 8 mm por limitador de abertura
  - RU** Ручка поворотная квадрат 8 мм для ограничителя

### 4300 OL



#### Technical Informations



- 4300 OL**
- IT** Nottolino Q.8 per limitatore
  - EN** Little handle square 8 for limiting
  - ES** Muletilla para cuadradillo 8 mm por limitador de abertura
  - RU** Ручка поворотная квадрат 8 мм для ограничителя

### PBC 6066502 OL



- PBC6066502 OL**
- IT** Kit pomolo PBC60 + maniglia S02 su rosetta Ø 50
  - EN** Kit knob PBC60 + handle S02 with roses Ø 50
  - ES** Kit con pomolo PCB60 y manilla S02, roseta Ø 50
  - RU** Комплект кноб PBC60 + ручка S02 с розеткой Ø 50

#### Technical Informations

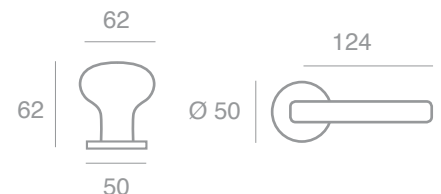



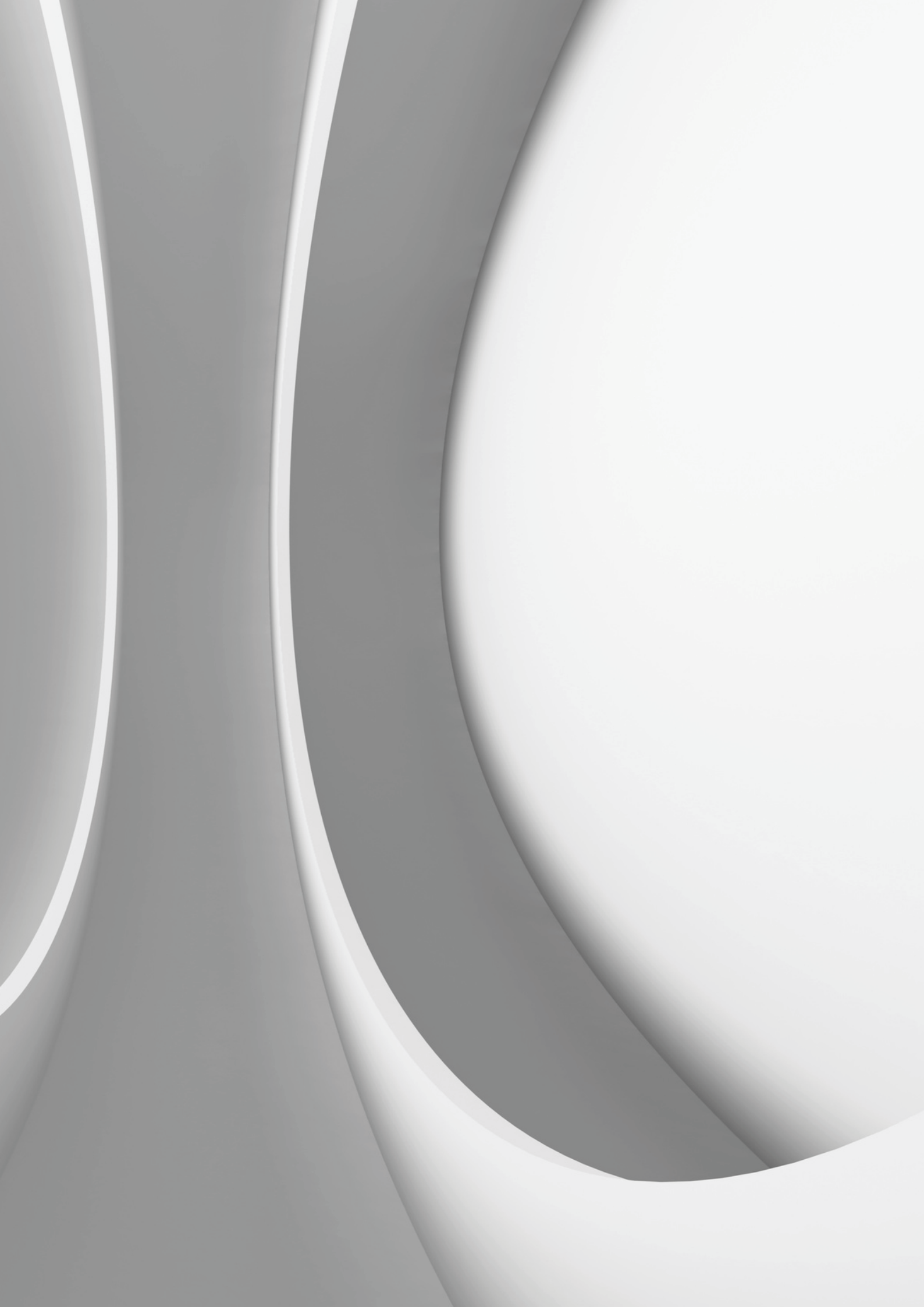

Italian Design Since 1972

**BRIALMA**  
made in italy  
since 1972



# Security Kit

Security Kit

Placas de

seguridad

Комплект

безопасности



PMA5063F1339Y



- IT** Kit sicurezza pomolo PMA50 + maniglia F13 su placca rettangolare tipo 3900 foro Yale
- EN** Security kit knob PMA50 + handle F13 on rectangular plate type 3900 PZ hole
- ES** Kit de seguridad con pomo PMA50 y manilla F13, con placa rectangular tipo 3900, bocallave Yale 4 posiciones
- RU** Комплект безопасности knob PMA50 + ручка F13 на прямоугольной планке тип 3900 с отверстием для цилиндра

**Technical Informations**

**L available:**  
72-88-90-92

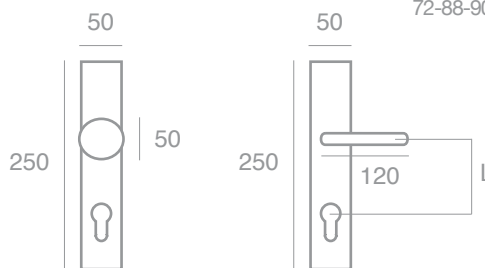

PAL4863F1339Y



- IT** Kit sicurezza pomolo PAL48 + maniglia F13 su placca rettangolare tipo 3900 foro Yale
- EN** Security kit knob PAL48 + handle F13 on rectangular plate type 3900 PZ hole
- ES** Kit de seguridad con pomo PAL48 y manilla F13, con placa rectangular tipo 3900, bocallave Yale
- RU** Комплект безопасности knob PAL48 + ручка F13 на прямоугольной планке тип 3900 с отверстием для цилиндра

**Technical Informations**

**L available:**  
72-88-90-92

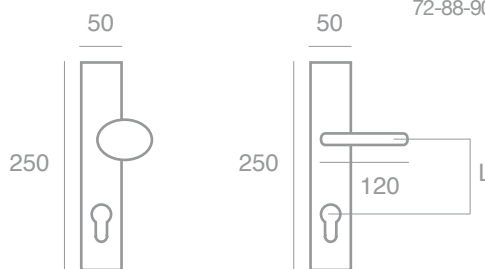

F1339Y



- IT** Kit sicurezza bilancino maniglia F13 su placca rettangolare tipo 3900 foro Yale
- EN** Security kit lever handle F13 on rectangular plate type 3900 PZ hole
- ES** Kit de seguridad y juego con manilla F13, con placa rectangular tipo 3900, bocallave Yale
- RU** Комплект безопасности нажимная ручка F13 на прямоугольной планке тип 3900 с отверстием для цилиндра

**Technical Informations**

**L available:**  
72-88-90-92

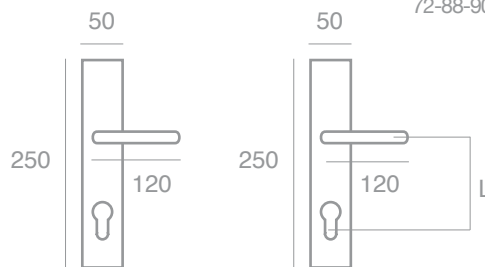



**PMA5063F1339K**



- IT** Kit sicurezza pomolo PMA50 + maniglia F13 su placca rettangolare tipo 3900 foro KS
- EN** Security kit knob PMA50 + handle F13 on rectangular plate type 3900 KS hole
- ES** Kit de seguridad con pomolo PMA50 y manilla F13, con placa rectangular tipo 3900, bocallave KS
- RU** Комплект безопасности knob PMA50 + ручка F13 на прямоугольной планке тип 3900 с отверстием KS

**Technical Informations**

**L available:**

72-88-90-92

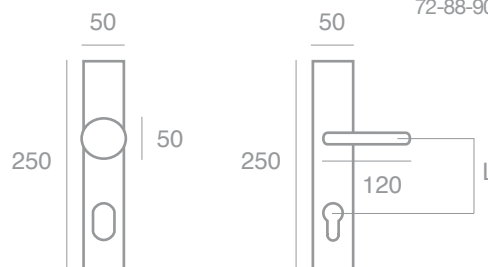

**PAL4863F1339K**



- IT** Kit sicurezza pomolo PAL48 + maniglia F13 su placca rettangolare tipo 3900 foro KS
- EN** Security kit knob PAL48 + handle F13 on rectangular plate type 3900 KS hole
- ES** Kit de seguridad con pomolo PAL48 y manilla F13, con placa rectangular tipo 3900, bocallave KS
- RU** Комплект безопасности knob PAL48 + ручка F13 на прямоугольной планке тип 3900 с отверстием KS

**Technical Informations**

**L available:**

72-88-90-92

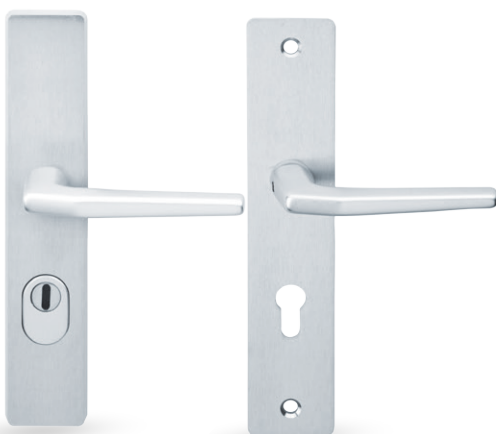
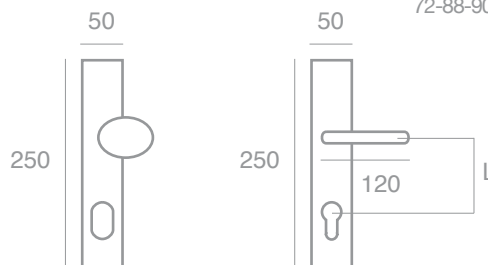

**F1339K**



- IT** Kit sicurezza bilancino maniglia F13 su placca rettangolare tipo 3900 foro KS
- EN** Security kit lever handle F13 on rectangular plate type 3900 KS hole
- ES** Kit de seguridad y juego con manilla F13, con placa rectangular tipo 3900, bocallave KS
- RU** Комплект безопасности нажимная ручка F13 на прямоугольной планке тип 3900 с отверстием KS

**Technical Informations**

**L available:**

72-88-90-92

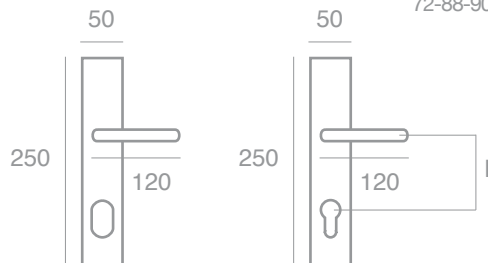



PMA5063E0637Y



- IT** Kit sicurezza pomolo PMA50 + maniglia E06 su placca ovale tipo 3700 foro Yale
- EN** Security kit knob PMA50 + handle E06 on oval plate type 3700 PZ hole
- ES** Kit de seguridad con pomo PMA50 y manilla E06, con placa oval tipo 3700, bocallave Yale
- RU** Комплект безопасности knob PMA50 + ручка E06 на овальной планке 3700 типа с отверстием под цилиндр

**Technical Informations**

**L available:**  
72-88-90-92

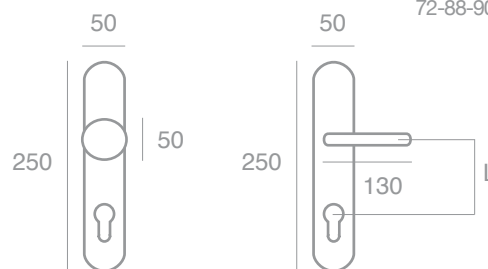

PKS7063E0637Y



- IT** Kit sicurezza pomolo PKS70 + maniglia E06 su placca ovale tipo 3700 foro Yale
- EN** Security kit knob PKS70 + handle E06 on oval plate type 3700 PZ hole
- ES** Kit de seguridad con pomo PKS70 y manilla E06, con placa oval tipo 3700, bocallave Yale
- RU** комплект безопасности knob PKS70 + ручка E06 на овальной планке 3700 типа с отверстием под цилиндр

**Technical Informations**

**L available:**  
72-88-90-92

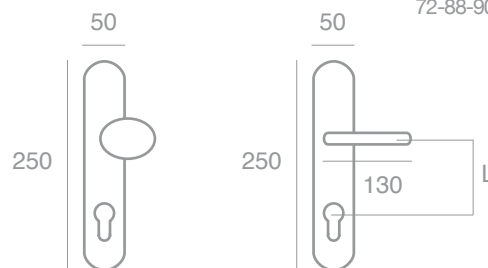

E0637Y



- IT** Kit sicurezza bilancino maniglia E06 su placca ovale tipo 3700 foro Yale
- EN** Security kit lever handle E06 on oval plate type 3700 PZ hole
- ES** Kit de seguridad con juego y manilla E06, con placa oval tipo 3700, bocallave Yale
- RU** Комплект безопасности нажимная ручка E06 на овальной планке 3700 типа с отверстием под цилиндр

**Technical Informations**

**L available:**  
72-88-90-92

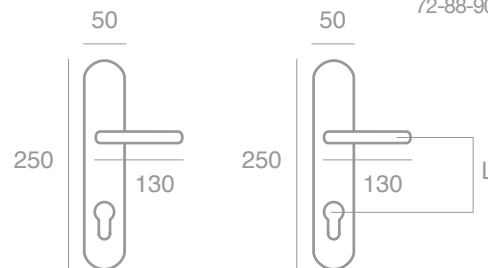





**PMA5063E0637K**



- IT** Kit sicurezza pomolo PMA50 + maniglia E06 su placca ovale tipo 3700 foro KS
- EN** Security kit knob PMA50 + handle E06 on oval plate type 3700 KS hole
- ES** Kit de seguridad con pomo PMA50 y manilla E06, con placa oval tipo 3700, bocallave KS
- RU** Комплект безопасности knob PMA50 + ручка E06 на закругленной планке 3700 типа с отверстием под цилиндр

**Technical Informations**

**L available:**

72-88-90-92

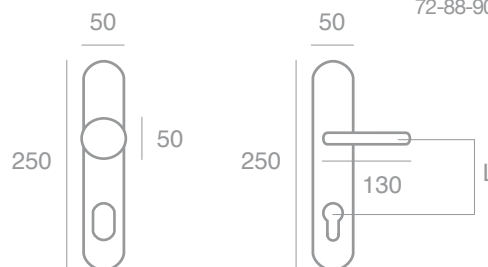

**PKS7063E0637K**



- IT** Kit sicurezza pomolo PKS70 + maniglia E06 su placca ovale tipo 3700 foro KS
- EN** Security kit knob PKS70 + handle E06 on oval plate type 3700 KS hole
- ES** Kit de seguridad con pomo PKS70 y manilla E06, con placa oval tipo 3700, bocallave KS
- RU** Комплект безопасности knob PKS70 + ручка E06 на закругленной планке 3700 типа с отверстием под цилиндр

**Technical Informations**

**L available:**

72-88-90-92

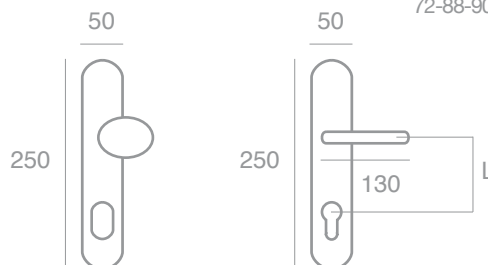

**E0637K**



- IT** Kit sicurezza bilancino maniglia E06 su placca ovale tipo 3700 foro KS
- EN** Security kit lever handle E06 on oval plate type 3700 KS hole
- ES** Kit de seguridad con juego y manilla E06, con placa oval tipo 3700, bocallave KS
- RU** Комплект безопасности нажимная ручка E06 на овальной планке 3700 типа с отверстием под цилиндр

**Technical Informations**

**L available:**

72-88-90-92

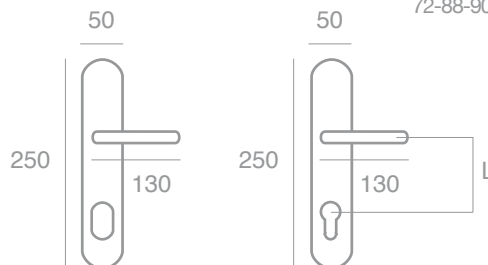

## 3710K

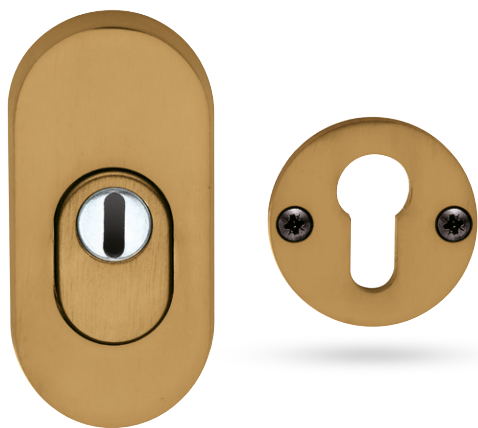

- 3710K**
- IT** Rosetta di sicurezza
  - EN** Security rose
  - ES** Roseta de seguridad
  - RU** Розетка безопасности



### Technical Informations



## 3910Y



- 3910Y**
- IT** Rosetta di sicurezza
  - EN** Security rose
  - ES** Roseta de seguridad
  - RU** Розетка безопасности



### Technical Informations

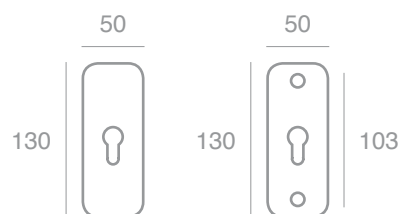

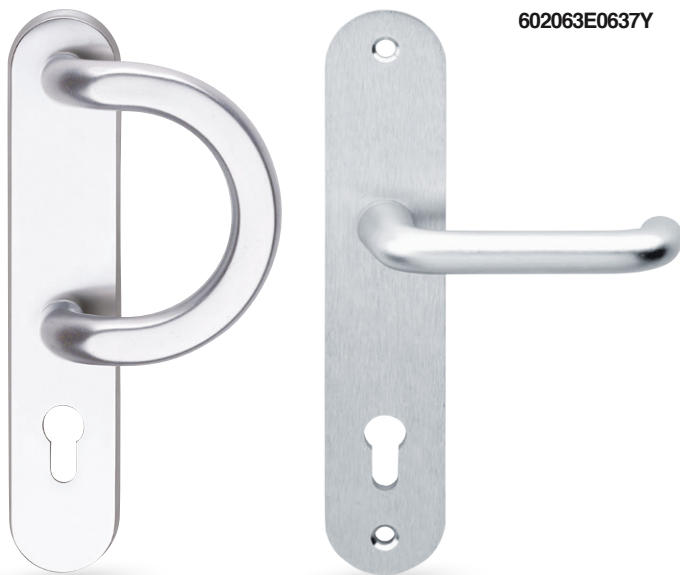

602063E0637Y

**IT** Kit sicurezza maniglione 6020 + maniglia E06 su placca ovale tipo 3700 foro yale

**EN** Security kit pull handle 6020 + handle E06 on oval plate type 3700 PZ hole

**ES** Kit de seguridad manillones 6020 y manilla E06, con placa oval tipo 3700, bocallave Yale

**RU** Комплект безопасности ручка скоба 6020+ ручка E06 на овальной планке 3700 типа с отверстием под цилиндр



**Technical Informations**

**L available: 90**

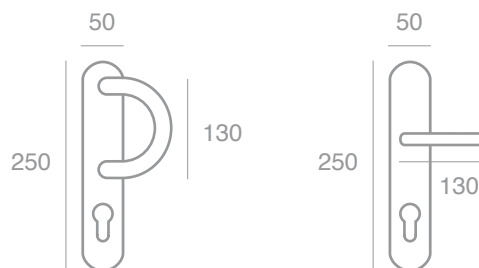

## Kit Hotel

PTO5063E0636Y85

**IT** Kit Hotel pomolo PTO50 + maniglia E06 su placca 3600 Y 85

**EN** Kit Hotel knob PTO50 + handle E06 on plate 3600 PZ 85

**ES** Kit para Hotel pomo PTO50 y manilla E06, con placa ovalada tipo 3600, bocallave Yale

**RU** Комплект Hotel knob PTO50 + ручка E06 на планке 3600 с отверстием для цилиндра



**Technical Informations**

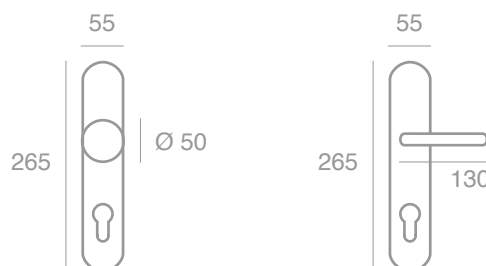

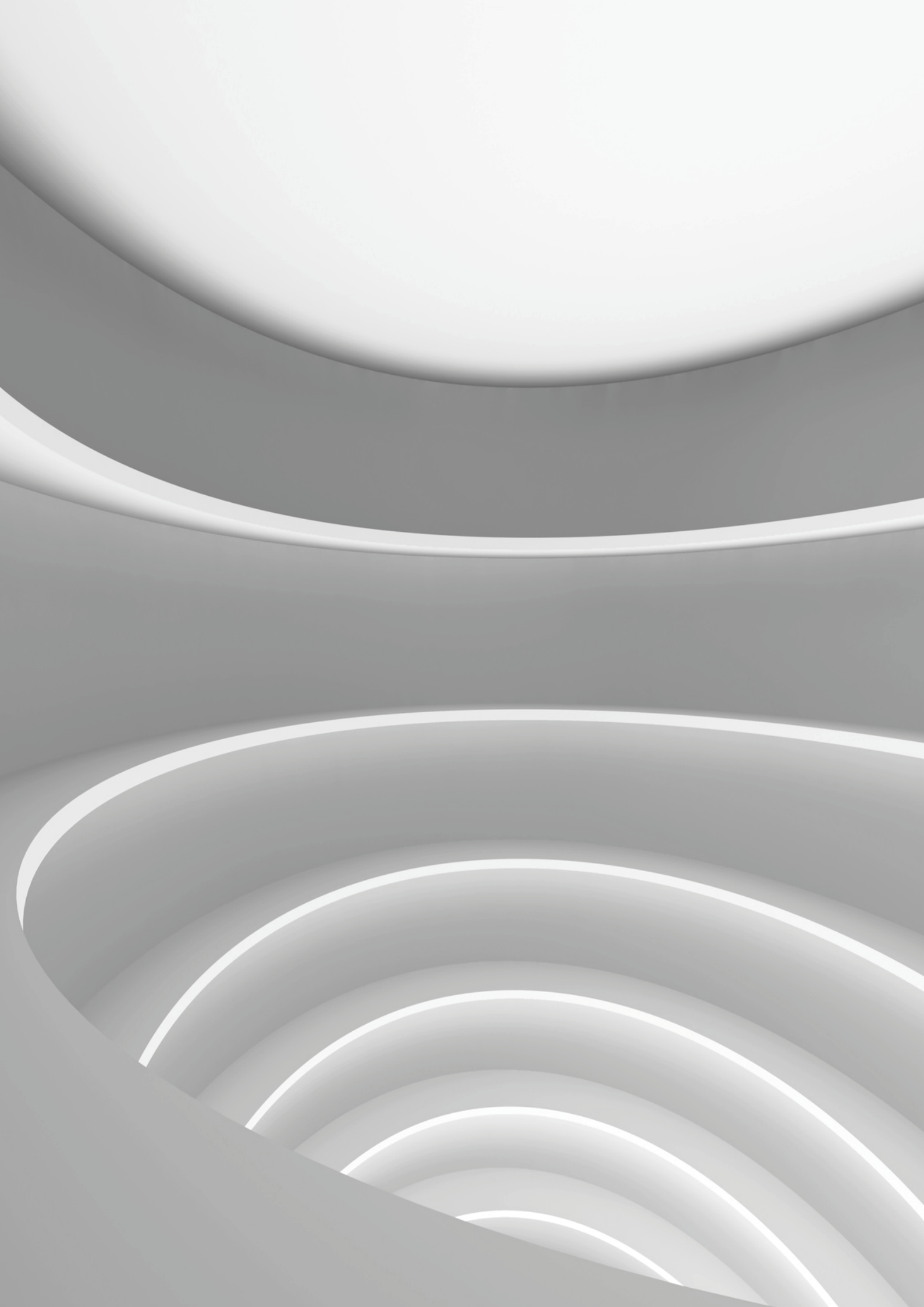

Italian Design Since 1972

**BRIALMA**  
made in italy  
since 1972



# Accessori Porte Scorrevoli

Accessories for  
Sliding Doors  
Accesorios para  
Puertas Correderas  
Аксессуары для  
раздвижных дверей

## 3805



3805

- IT** Maniglia incasso ovale, coprivite
- EN** Oval handle for sliding door, concealed fixing
- ES** Manilla de encajo ovalada sin tornillos visibles
- RU** Врезная ручка, скрытая фиксация



## Technical Informations



## 3806



3806

- IT** Maniglia incasso ovale, viti in vista
- EN** Oval handle for sliding door, exposed fixing
- ES** Manilla de encajo ovalada con tornillos visibles
- RU** Овальная ручка для раздвижных дверей, с видимой фиксацией



## Technical Informations

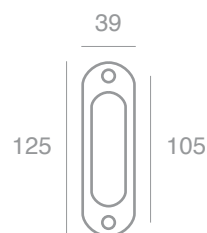

## 3800



3800

- IT** Maniglia incasso, viti in vista
- EN** Sliding door handle, exposed fixing
- ES** Manilla de encajo con tornillos visibles
- RU** Ручка для раздвижных дверей, с видимой фиксацией



### Technical Informations

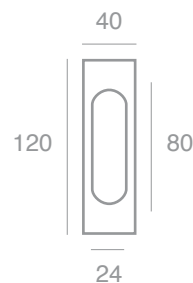

## 3810



3810

- IT** Maniglia per porta scorrevole, viti in vista
- EN** Sliding door handle, exposed fixing
- ES** Tirador para puerta corredera
- RU** Ручка для раздвижных дверей, видимая фиксация



### Technical Informations



## 15000



- 15000**
- IT** Coppia maniglia incasso Ø 59 x 11.5 con nottolino
  - EN** Pair of sliding door handle Ø 59 x 11.5 with turn
  - ES** Juego tiradores para puerta corredera Ø.59 X 11.5 con muletilla y desbloqueo
  - RU** Пара ручек для раздвижных дверей Ø.59 X 11.5 с сантехнической заверткой



## Technical Informations



## 15100



- 15100**
- IT** Coppia maniglia incasso Ø 59 x 11 con doppio nottolino
  - EN** Pair of sliding door handle Ø.59 X 11 with turn on both sides
  - ES** Juego tiradores para puerta corredera Ø 59 X 11 con muletilla en los dos lados
  - RU** пара ручек для раздвижных дверей Ø 59 X 11 с заверткой на обеих сторонах



## Technical Informations



## 16000



- 16000**
- IT** Trascinatore
  - EN** Flush pull hole
  - ES** Tirador frontal
  - RU** Торцевой захват

## Technical Informations

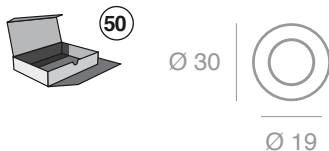

## 3820C



- 3820C**
- IT** Bocchetta
  - EN** Escutcheon
  - ES** Bocallave
  - RU** Накладка

## Technical Informations

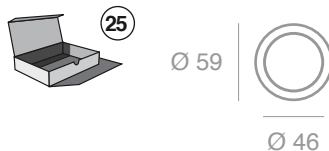

## 3820P



- 3820P**
- IT** Bocchetta
  - EN** Escutcheon
  - ES** Bocallave
  - RU** Накладка

## Technical Informations

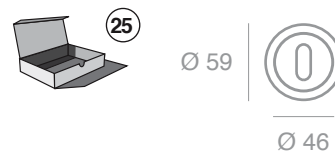



## 15500



15500

- IT** Coppia maniglia incasso 59x59 con nottolino
- EN** Pair of sliding door square handle 59 x 59 with turn
- ES** Par de manijas de embutir o manijas empotradas 59x59 con pestillo
- RU** Пара врезных ручек 59x59 с заверткой

### Technical Informations



## 3830C



3830C

- IT** Bocchetta
- EN** Escutcheon
- ES** Bocallave
- RU** Накладка

### Technical Informations



## 3830P



3830P

- IT** Bocchetta
- EN** Escutcheon
- ES** Bocallave
- RU** Накладка

### Technical Informations

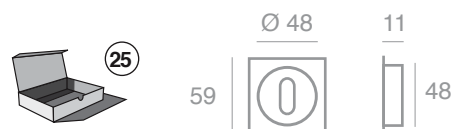

## LOCK01



### LOCK01

- IT** Serratura per maniglia incasso
- EN** Lock for sliding door handles
- ES** Picaporte para tiradores puerta corredera
- RU** Замок для раздвижных дверей

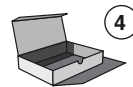

#### Technical Informations

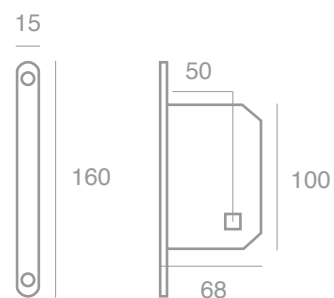

## LOCK02

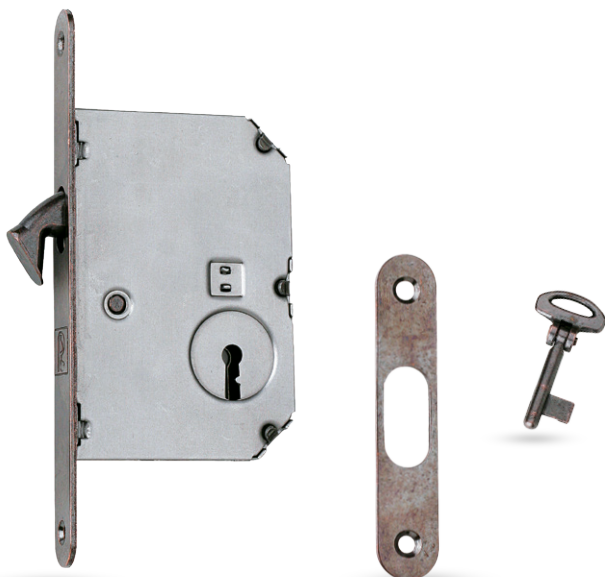

### LOCK02

- IT** Serratura con foro chiave per maniglia incasso
- EN** Lock with key hole for sliding door handles
- ES** Cerradura con bocallave gorjas para tiradores puerta corredera
- RU** Замок для раздвижных дверей с отверстием под кабинетный ключ



#### Technical Informations

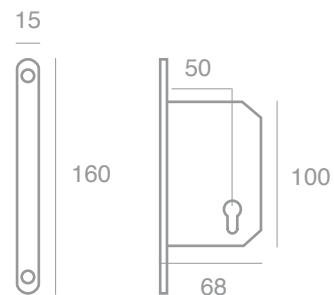

Ø 45

### 9100P



#### Technical Informations



- IT** Bocchetta
- EN** Escutcheon
- ES** Bocallave
- RU** Накладка

### 8000



#### Technical Informations



- IT** Rosetta
- EN** Rose
- ES** Roseta
- RU** Розетка

### 9100Y



#### Technical Informations



- IT** Bocchetta
- EN** Escutcheon
- ES** Bocallave
- RU** Накладка

### 9200P

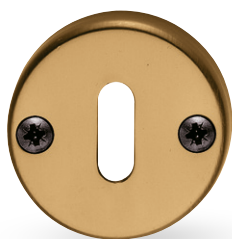

#### Technical Informations

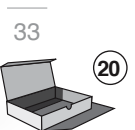

- IT** Bocchetta
- EN** Escutcheon
- ES** Bocallave
- RU** Накладка

### 8200

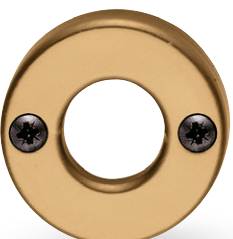

#### Technical Informations

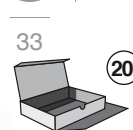

- IT** Rosetta
- EN** Rose
- ES** Roseta
- RU** Розетка

### 9200Y



#### Technical Informations

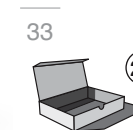

- IT** Bocchetta
- EN** Escutcheon
- ES** Bocallave
- RU** Накладка

### 4100

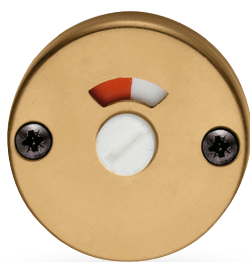

- IT** Rosetta con nottolino WC Ø 50 viti in vista
- EN** WC set with rose Ø 50, exposed fixing
- ES** Condena y desbloqueo por WC con roseta Ø 50 con tornillos visibles
- RU** Комплект для санузла на розетке Ø 50 с видимой фиксацией



#### Technical Informations

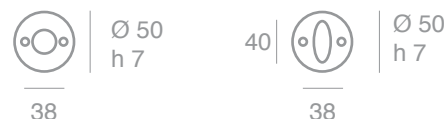

### 4500

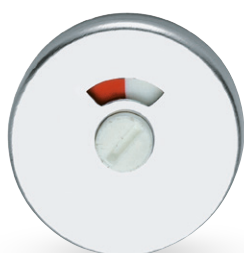

- IT** Rosetta con nottolino WC Ø 45 coprivite
- EN** WC set with rose Ø 45, concealed fixing
- ES** Condena y desbloqueo por WC con roseta Ø 45
- RU** Комплект для санузла на розетке Ø 45 со скрытой фиксацией



#### Technical Informations



Ø 47

**8900**



**8900** **IT** Rosetta  
**EN** Rose  
**ES** Roseta  
**RU** Розетка

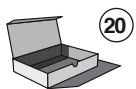

20

**Technical Informations**



Ø 47  
h 11

**9900Y**



**9900Y** **IT** Bocchetta  
**EN** Escutcheon  
**ES** Bocallave  
**RU** Накладка



20

**Technical Informations**



Ø 47  
h 11

**9900B**



**9900B** **IT** Bocchetta  
**EN** Escutcheon  
**ES** Bocallave  
**RU** Накладка

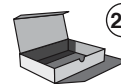

20

**Technical Informations**



Ø 47  
h 11

Ø 50

**9400P**

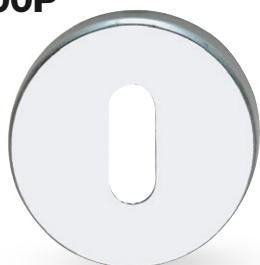

**9400P** **IT** Bocchetta  
**EN** Escutcheon  
**ES** Bocallave  
**RU** Накладка



20

**Technical Informations**



Ø 50 h 7

**8100**

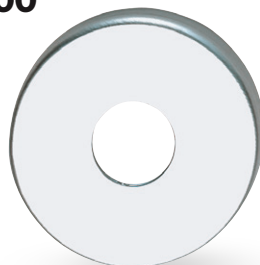

**8100** **IT** Rosetta  
**EN** Rose  
**ES** Roseta  
**RU** Розетка



20

**Technical Informations**



Ø 50 h 7

**9400Y**



**9400Y** **IT** Bocchetta  
**EN** Escutcheon  
**ES** Bocallave  
**RU** Накладка



20

**Technical Informations**



Ø 50 h 7

∅ 50

### 9400D



- IT** Bocchetta Ø 50 foro doppia mappa
- EN** Escutcheon Ø 50 double ward hole
- ES** Bocallave Ø 50 para puertas acorazadas
- RU** Накладка Ø 50 с отверстием под сувальдный ключ

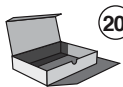

#### Technical Informations



∅ 50 h 7

### 9400T

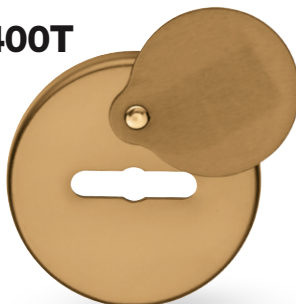

- IT** Rosetta Ø 50 con schermo
- EN** Round rose Ø 50 double ward hole, with shield
- ES** Roseta Ø 50 con protección
- RU** Накладка Ø 50 с отверстием под сувальдный ключ, со шторкой



#### Technical Informations



∅ 50 h 7

### 9400C



- IT** Rosetta Ø 50 cieca
- EN** Blind escutcheon Ø 50
- ES** Roseta Ø 50 ciega
- RU** Глухая накладка Ø 50



#### Technical Informations



∅ 50 h 7

### 9400K



### 9400K

- IT** Bocchetta Ø 50
- EN** Escutcheon Ø 50
- ES** Bocallave Ø 50
- RU** Накладка Ø 50



#### Technical Informations



∅ 50 h 7



∅ 50 h 7

## 5000TM



## 5000TM

- IT** Nottolino WC su rosetta Ø 50 con taglio-moneta in metallo
- EN** WC set on rose Ø 50 with metallic pin
- ES** Condena por WC con desbloqueo en metal y roseta Ø 50
- RU** Комплект розеток для санузла Ø 50 с пластиковым штифтом



### Technical Informations

Ø 20 | | Ø 50 h 7    Ø 20 | | Ø 50 h 7

## 4000



## 4000

- IT** Rosetta con nottolino WC Ø 50 coprivite
- EN** WC set with rose Ø 50, concealed fixing
- ES** Condena y desbloqueo por WC con roseta Ø 50
- RU** Комплект розеток для санузла Ø 50 с пластиковым штифтом



### Technical Informations

| Ø 50 h 7    40 | | Ø 50 h 7

## 4000TM



## 4000TM

- IT** Nottolino WC su rosetta Ø 50 con taglio-moneta in metallo
- EN** WC set on rose Ø 50 with metallic pin
- ES** Condena por WC con desbloqueo en metal y roseta Ø 50
- RU** Комплект розеток для санузла Ø 50 с пластиковым штифтом



### Technical Informations

Ø 20 | | Ø 50 h 7    40 | | Ø 50 h 7

## 7000P



- IT** Bocchetta spessore ridotto
- EN** Escutcheon reduced thickness
- ES** Bocallave con espesor reducido
- RU** Накладка с уменьшенной толщиной

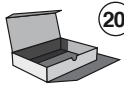

### Technical Informations



Ø 50 h 3,5

## 10000



- IT** Rosetta spessore ridotto
- EN** Rose reduced thickness
- ES** Roseta con espesor reducido
- RU** Розетка с уменьшенной толщиной

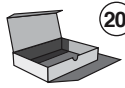

### Technical Informations



Ø 50 h 3,5

## 7000Y



- IT** Bocchetta spessore ridotto
- EN** Escutcheon reduced thickness
- ES** Bocallave con espesor reducido
- RU** Накладка с уменьшенной толщиной

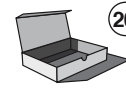

### Technical Informations



Ø 50 h 3,5

## 7200P



- IT** Bocchetta quadra 50x50 foro ovale spessore ridotto
- EN** Square rose 50x50 oval hole reduced thickness
- ES** Bocallave cuadrada mm 50x50 gorjas oval con espesor reducido
- RU** Квадратная накладка 50x50 с отверстием под кабинетный ключ, с уменьшенной толщиной



### Technical Informations



50 h 3,5

## 12000



- IT** Rosetta quadra 50x50 spessore ridotto
- EN** Square rose 50x50 reduced thickness
- ES** Roseta cuadrada mm 50x50 con espesor reducido
- RU** Квадратная накладка 50x50 с отверстием под кабинетный ключ, с уменьшенной толщиной



### Technical Informations



50 h 3,5

## 7200Y



- IT** Bocchetta quadra 50x50 foro Yale spessore ridotto
- EN** Square rose 50x50 PZ hole reduced thickness
- ES** Bocallave cuadrada mm 50x50 Yale con espesor reducido
- RU** Квадратная накладка 50x50 с отверстием под цилиндр, с уменьшенной толщиной



### Technical Informations



50 h 3,5

# 50x50

## 4700TM



**IT** Nottolino WC su rosetta quadra 50x50 con taglio-moneta in metallo

**EN** WC set on square rose 50x50 with metallic pin

**ES** Pestillo WC sobre roseta cuadrada con desbloqueo en metal

**RU** Комплект заверток для санузла на квадратной розете 50x50 с металлическим штифтом и наружной прорезью видимая фиксация

### Technical Informations



## 4700



**IT** Nottolino WC su rosetta quadra 50x50 coprivite

**EN** WC set on square rose 50x50, concealed fixing

**ES** Condena y desbloqueo por WC con roseta cuadrada mm 50x50

**RU** Комплект розеток для санузла 50x50 видимая фиксация

### Technical Informations



## 9700P



## 9700Y



### 9700P

**IT** Bocchetta quadra 50x50 foro chiave

**EN** Square escutcheon 50x50 key hole

**ES** Bocallave cuadrada mm 50x50, bocallaves gorjas

**RU** Квадратная накладка 50x50 с отверстием под кабинетный ключ

### 9700Y

**IT** Bocchetta quadra 50x50 foro Yale

**EN** Square escutcheon 50x50 PZ hole

**ES** Bocallave cuadrada mm 50x50, bocallaves Yale

**RU** Квадратная накладка 50x50 с отверстием под цилиндр



## 8700



### 8700

**IT** Rosetta quadra 50x50

**EN** Square rose 50x50

**ES** Roseta cuadrada mm 50x50

**RU** Квадратная розетка 50x50





Ø 52

### 9500B



**9500B**

- IT** Bocchetta
- EN** Escutcheon
- ES** Bocallave
- RU** Накладка



**Technical Informations**



Ø 52 h 10

### 8500



**8500**

- IT** Rosetta
- EN** Rose
- ES** Roseta
- RU** Розетка



**Technical Informations**



Ø 52 h 10

### 9500Y



**9500Y**

- IT** Bocchetta
- EN** Escutcheon
- ES** Bocallave
- RU** Накладка

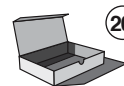

**Technical Informations**



Ø 52 h 10

### 4200



**4200**

- IT** Rosetta con nottolino WC Ø 52 coprivate
- EN** WC set with rose Ø 52, concealed fixing
- ES** Condena y desbloqueo por WC con roseta Ø 52
- RU** Комплект розеток для санузла Ø 52 с пластиковым штифтом



**Technical Informations**



Ø 52 h 10

40



Ø 52 h 10

## 4200PM



4200PM

- IT** Nottolino WC su rosetta Ø 52 con taglio-moneta in plastica
- EN** WC set on rose Ø 52 with plastic pin
- ES** Condena por WC con desbloqueo en plástico y roseta Ø 52
- RU** Комплект розеток для санузла Ø 52 с пластиковым штифтом



### Technical Informations



## 4200TM



4200TM

- IT** Nottolino WC su rosetta Ø 52 con taglio-moneta in metallo
- EN** WC set on rose Ø 52 with metallic pin
- ES** Condena por WC con desbloqueo en metal y roseta Ø 52
- RU** Комплект розеток для санузла Ø 52 с пластиковым штифтом



### Technical Informations



∅ 55

### 4800TM



**4800TM** **IT** Nottolino WC su rosetta ∅.55 con taglio-moneta in metallo  
**EN** WC set on rose ∅ 55 with metallic pin  
**ES** Pestillo WC sobre roseta ∅.55 con desbloqueo en metal  
**RU** Комплект заверток для санузла на розете ∅.55 с металлическим штифтом и наружной прорезью



#### Technical Informations

∅ 20 |  | ∅ 55 h 10 | 40 |  | ∅ 55 h 10

### 7100P



**IT** Bocchetta  
**EN** Escutcheon  
**ES** Bocallave  
**RU** Накладка



#### Technical Informations

 | ∅ 55 h 9

### 11000



**IT** Rosetta  
**EN** Rose  
**ES** Roseta  
**RU** Розетка



#### Technical Informations

 | ∅ 55 h 9

### 7100Y



**IT** Bocchetta  
**EN** Escutcheon  
**ES** Bocallave  
**RU** Накладка



#### Technical Informations

 | ∅ 55 h 9

68 x 28

### 9600P

**IT** Bocchetta  
**EN** Escutcheon  
**ES** Bocallave  
**RU** Накладка

#### Technical Informations

68 |  | 28



### 8300

**IT** Rosetta  
**EN** Rose  
**ES** Roseta  
**RU** Розетка

#### Technical Informations

68 |  | 28



### 9600Y

**IT** Bocchetta  
**EN** Escutcheon  
**ES** Bocallave  
**RU** Накладка

#### Technical Informations

68 |  | 28



62 x 32

### 9800P

- IT** Bocchetta
- EN** Escutcheon
- ES** Bocallave
- RU** Накладка



#### Technical Informations



### 8400

- IT** Rosetta
- EN** Rose
- ES** Roseta
- RU** Розетка



#### Technical Informations



### 9800Y

- IT** Bocchetta
- EN** Escutcheon
- ES** Bocallave
- RU** Накладка



#### Technical Informations

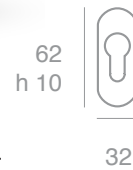

### 4600



### 4600

- IT** Nottolino WC su rosetta ovale coprivite
- EN** WC set on oval rose, concealed fixing
- ES** Condena y desbloqueo por WC con roseta ovalada
- RU** Комплект розеток для санузла Ø 52 со скрытой фиксацией

#### Technical Informations



### 4600TM



### 4600TM

- IT** Nottolino WC su rosetta ovale con taglio-moneta in metallo
- EN** WC set on oval rose with metallic pin
- ES** Pestillo WC sobre roseta ovalada con desbloqueo en metal
- RU** Комплект заверток для санузла на овальной розете с металлическим штифтом и наружной прорезью

#### Technical Informations



60 x 30

### 8600

- IT** Rosetta
- EN** Rose
- ES** Roseta
- RU** Розетка



#### Technical Informations

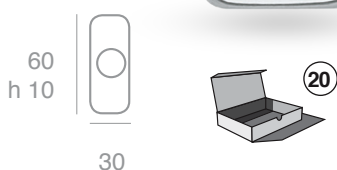

### 9000Y

- IT** Bocchetta
- EN** Escutcheon
- ES** Bocallave
- RU** Накладка



#### Technical Informations

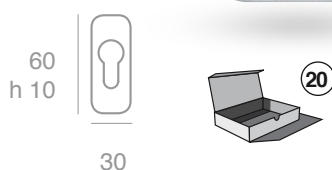

### 9000P

- IT** Bocchetta
- EN** Escutcheon
- ES** Bocallave
- RU** Накладка



#### Technical Informations

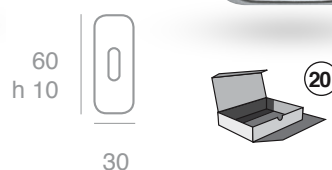

### 4400TM



### 4400TM

- IT** Nottolino WC su rosetta rettangolare con taglio moneta in metallo
- EN** WC set on rectangular rose with metallic pin
- ES** Pestillo WC sobre roseta rectangular con desbloqueo en metal
- RU** Комплект заверток для санузла на прямоугольной Ø.55 с металлическим штифтом и наружной прорезью

#### Technical Informations



2000



- IT** Placca
- EN** Plate
- ES** Placa
- RU** Планка

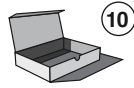

Technical Information

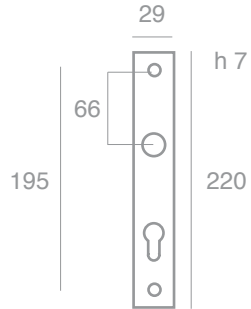

2000L

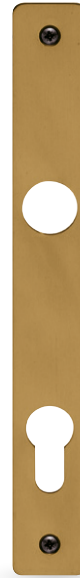

- IT** Placca
- EN** Plate
- ES** Placa
- RU** Планка



Technical Information

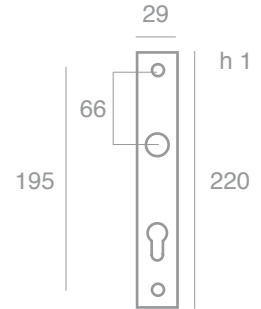

2100



- IT** Placca
- EN** Plate
- ES** Placa
- RU** Планка



Technical Information

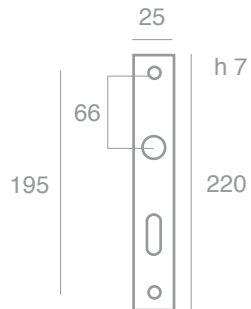

2200



- IT** Placca
- EN** Plate
- ES** Placa
- RU** Планка



Technical Information

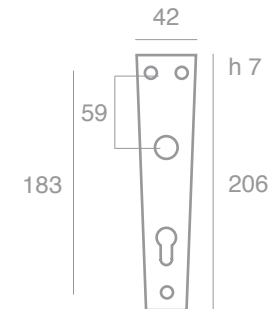

2200WC

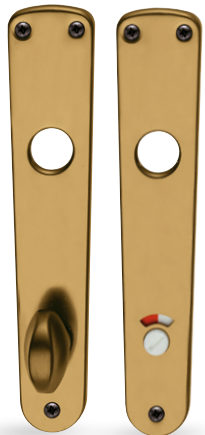

- IT** Placca
- EN** Plate
- ES** Placa
- RU** Планка

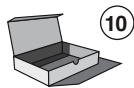

Technical Information

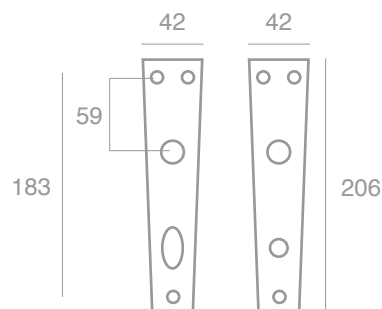

2300



- IT** Placca
- EN** Plate
- ES** Placa
- RU** Планка



Technical Information

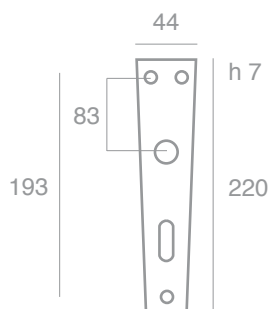

**2400**



- IT** Placca
- EN** Plate
- ES** Placa
- RU** Планка



**Technical Informations**

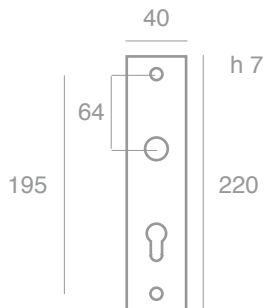

**2500**



- IT** Placca
- EN** Plate
- ES** Placa
- RU** Планка



**Technical Informations**

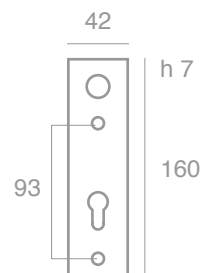

**26002F**



- IT** Placca
- EN** Plate
- ES** Placa
- RU** Планка



**Technical Informations**

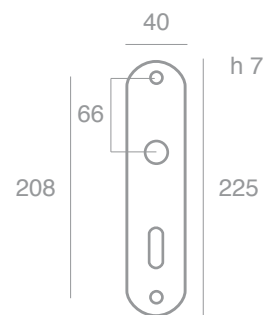

**26004F**



- IT** Placca
- EN** Plate
- ES** Placa
- RU** Планка



**Technical Informations**

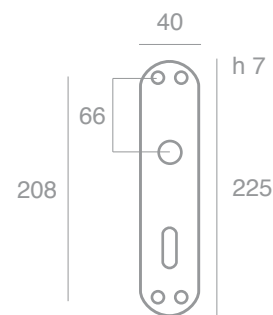

**2700**



- IT** Placca
- EN** Plate
- ES** Placa
- RU** Планка



**Technical Informations**

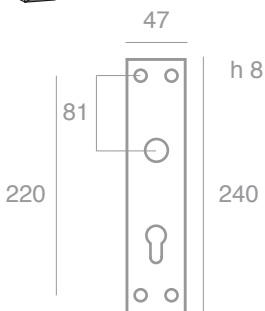

**2800**



- IT** Placca
- EN** Plate
- ES** Placa
- RU** Планка



**Technical Informations**

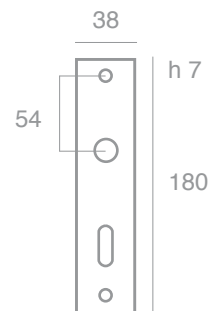

2900



- IT** Placca ovale 225x24
- EN** Oval plate 225x24
- ES** Placa oval 225x24
- RU** Овальная планка 225x24

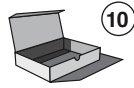

**Technical  
Information**

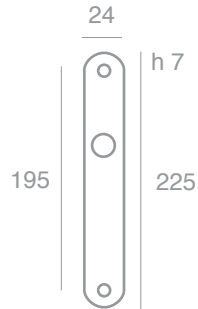

3000



- IT** Placca
- EN** Plate
- ES** Placa
- RU** Планка

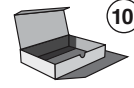

**Technical  
Information**

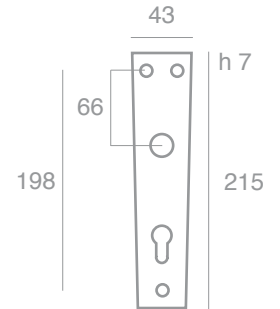

3100



- IT** Placca ovale 185x40
- EN** Oval plate 185x40
- ES** Placa oval 185x40
- RU** Овальная планка 185x40

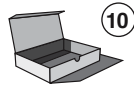

**Technical  
Information**

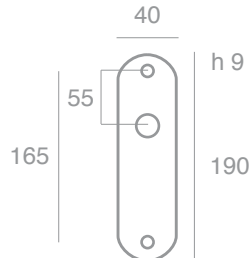

3200



- IT** Placca rettangolare 185x40
- EN** Rectangular plate 185x40
- ES** Placa rectangular 185x40
- RU** Прямоугольная планка 185x40

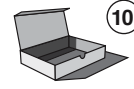

**Technical  
Information**

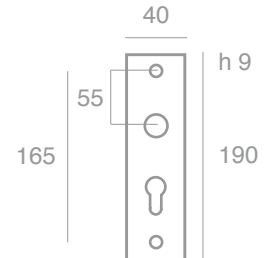

3300



- IT** Placca rettangolare 245x31
- EN** Rectangular plate 245x31
- ES** Placa rectangular 245x31
- RU** Прямоугольная планка 245x31



**Technical  
Information**

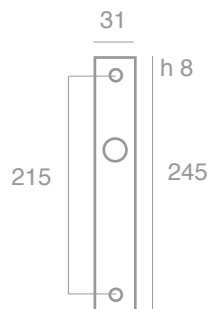

34002F



- IT** Placca ovale 245x30
- EN** Oval plate 245x30
- ES** Placa oval 245x30
- RU** Овальная планка 245x30



**Technical  
Information**

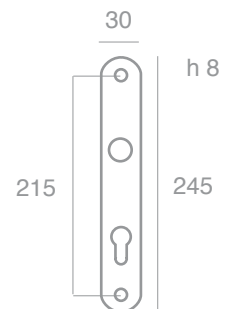





# Parti metalliche

Components | Componentes metálicos | комплектующие из металла

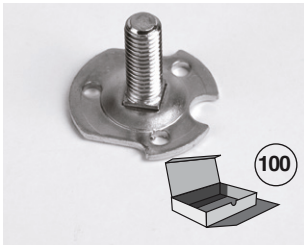

## PF35M8X25

- IT** Piastrina di fissaggio univ. D.35 con filetto M8X25
- EN** Standard fixing plate D.35 with thread M8X25
- ES** Plaqueta de fijación universal D.35 con rosca M8x25
- RU** Пластина для фиксации универсальная D.35 с резьбой M8X25



## PF35Q8X25

- IT** Piastrina di fissaggio univer. D.35 con ferro Q.8
- EN** Standard fixing plate D.35 with spindle Q.8
- ES** Plaqueta de fijación universal D35 con cuadro 8
- RU** Пластина для фиксации универсальная D.35 с металлическим квадратом 8 мм



## F8X120T1FZN

- IT** Ferro 8X120 mm. tipo taglio 1 fresatura - zincato
- EN** Spindle 8x120 mm. type: 1 cut zinc plated
- ES** Eje 8x120 mm tipo 1 corte 1 surco • galvanizado
- RU** Квадрат 8X120 мм с прорезью и фрезировкой оцинкованный



## F8X120T2FZN

- IT** Ferro 8X120 mm. tipo tagli 2 fresature - zincato
- EN** Spindle 8x120 mm. type: 2 cut zinc plated
- ES** Eje 8x120 mm Tipo 2 cortes 2 surcos galvanizado
- RU** Квадрат 8X120 мм с прорезями и фрезировкой с двух сторон оцинкованный

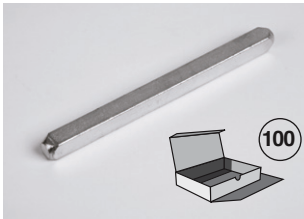

## F8X120INGR

- IT** Ferro 8X120 mm. tipo intero - zincato
- EN** Spindle 8x120 mm. whole made zinc plated
- ES** Eje 8x120 mm Tipo entero galvanizado
- RU** Квадрат 8X120 мм цельный оцинкованный

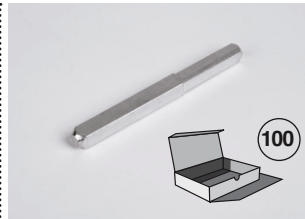

## F6-7X65INZN

- IT** Ferro 6-7X65 mm. tipo intero - zincato
- EN** Spindle 6-7x65 mm. whole made zinc plated
- ES** Eje 6-7x65 mm Tipo entero galvanizado
- RU** Квадрат 6-7X65 мм цельный оцинкованный



## F8X80ESZN

- IT** Ferro 8X80 mm. tipo espansione - zincato
- EN** Spindle 8x80 mm. expansion type zinc plated
- ES** Eje 8x80 tipo de expansion galvanizado
- RU** Квадрат 8X80 мм распорный оцинкованный

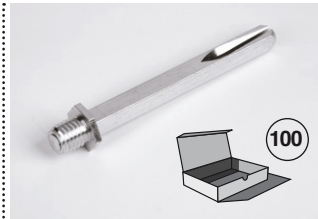

## F8X80N1GR

- IT** Ferro 8X80 mm. tipo con niple MB14 - zincato
- EN** Spindle 8x80 mm. with niple MB 14 type zinc plated
- ES** Eje 8x80 tipo con nipes galvanizado
- RU** Квадрат F8X80 мм с резьбой MB14



## F8X90N3GR

- IT** Ferro 8X90 mm. tipo con niple MA10 - zincato
- EN** Spindle 8x90 mm. with niple MA 10 type zinc plated
- ES** Eje 8x90 tipo nipes
- RU** Квадрат 8X90 мм с резьбой MA10 оцинкованный



## F8X70RRZN

- IT** Ferro 8x70 mm. con rondella - zincato
- EN** Spindel 8X70 mm. with round lock • zinc plated
- ES** Eje 8x70mm con rondana galvanizado
- RU** Квадрат 8X70 мм с шайбой оцинкованный

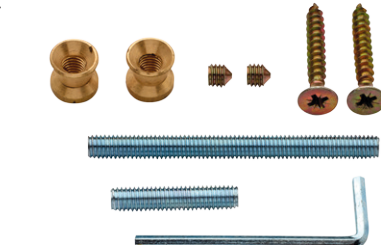

## KIT - FIS

- IT** Kit componenti per fissaggio maniglioni
- EN** Fixing spare parts for pull handles
- ES** Kit componentes para la fijación de los manillones
- RU** Комплект компонентов для фиксации стационарных ручек-скоб

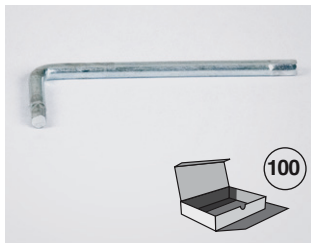

### CHIAVE3

- IT** Chiave esagonale 3 mm
- EN** Hexagonal key 3 mm
- ES** Llave hexagonal 3 mm
- RU** Гексагональный ключ 3 мм

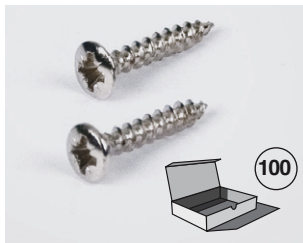

### VL3,5X20NKC2

- IT** Conf. 2 viti legno 3,5X20 mm TGS croce nichelate
- EN** Set of 2 screws for wood 3,5X20 mm. nickel plated
- ES** Conf. 2 tornillos para madera 3,5x20mm TGS de cruz níquel
- RU** Комплект из 2 винтов для фиксации в дерево 3,5X20 мм TGS покрытых никелем



### VM5X40C2

- IT** Conf. 2 viti M5X40 mm TPS croce nichelate
- EN** Set of 2 screws M5X40 mm. nickel plated
- ES** Conf. 2 tornillos M5X40 mm de cruz níquel
- RU** Комплект из 2 винтов M5X40 мм TPS покрытых никелем

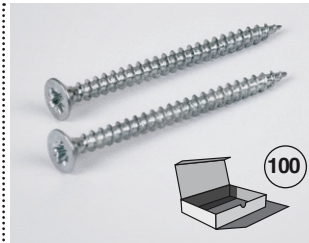

### VA4X50NKC2

- IT** Conf. 2 viti autofilettanti 4X50mm TPS croce nichelate
- EN** Set of 2 tapping screws 4X50 mm. nickel plated
- ES** Conf. 2 tornillos autorroscantes 4X50mm TPS de cruz níquel
- RU** Комплект из 2 самонарезающихся винтов 4X50 мм TPS покрытых никелем



### VKIT1

- IT** Conf. 2 viti M4X60 TGS + 2 bussole 4X20 TGS nichelate
- EN** Kit of 2 screws M4X60 TGS + 2 bushes 4X20 nickel plated
- ES** Conf. 2 tornillos M4x60 + 2 tuercas conector 4x20 TGS níquel
- RU** Комплект из 2 винтов M4X60 TGS + 2 болта 4X20 TGS покрытых никелем

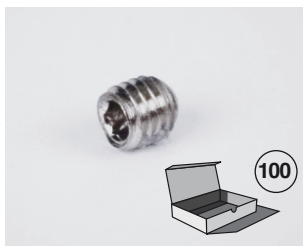

### G6X6CB

- IT** Grano 6X6 a coppa nichelato
- EN** Flat fixing screw 6X6 nickel plated
- ES** Tornillo de fijación plano 6x6 de punta plana níquel
- RU** Гужон 6X6 никелированный



### F8X80N1GR

- IT** Grano 6X9 punta 60° nichelato
- EN** Fixing screw 6X9 60° nickel plated
- ES** Tornillo de fijación plano 6x9 puntiagudo 60° níquel
- RU** Гужон 6X9 никелированный

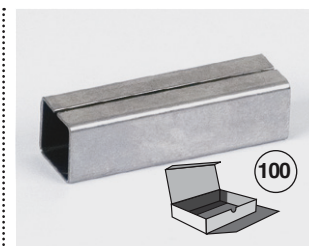

### RID6X7X30

- IT** Riduzione di ferro da 6 a 7 lungh. 30 mm
- EN** Metallic reduction from 6 to 7 lenght 30 mm
- ES** Adapdador de eje de 6 a 7 longitud 30mm
- RU** Металлический редуктор на 6 и на 7 мм длиной 30 мм

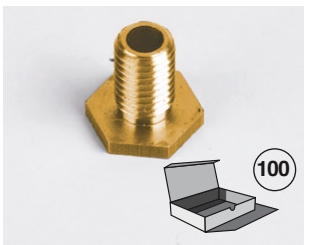

### D10X9

- IT** Dadino ottone MA10 altezza 19 mm forato
- EN** Brass fixing nut MA10 hight 19
- ES** Tuerca MA10h. 19 mm perforada
- RU** Гайка MA10 h. 19 мм с отверстием внутри

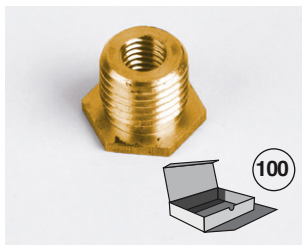

### D14X14

- IT** Dadino ottone MB14 H 14 mm con filetto interno M8
- EN** Brass fixing nut MB14 H 14 with internal threath M8
- ES** Tuerca MB14 h. 14 mm con rosca hembra M8
- RU** Гайка MB14 h. 14 мм с внутренней резьбой M8

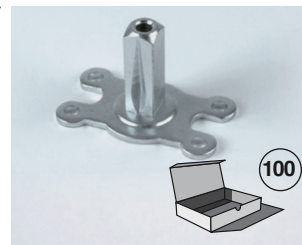

### PF48Q8X25

- IT** Piastrina di fissaggio per rosetta ovale con ferro Q.8
- EN** Standard fixing plate for oval rose with spindle Q.8
- ES** Plaqueta de fijación para roseta ovalada con eje cuadro 8
- RU** Пластина для фиксации для овальной розеты с квадратом Q.8

## Parti metalliche | Components | Componentes metálicos | комплектующие из металла



<b>codice</b> <small>code   código   код</small>	<b>descrizione</b> <small>description   descripción   описание</small>
<b>RID6X7X20</b>	<b>Riduzione di ferro da 6 a 7 lunghezza 20 mm</b>   Metallic reduction from 6 to 7 lenght 20 mm   Adapdador de eje de 6 a 7 longitud 20mm   Металлический редуктор на 6 и на 7 мм длиной 20 мм
<b>RID6X8X20</b>	<b>Riduzione di ferro da 6 a 8 lunghezza 20 mm</b>   Metallic reduction from 6 to 8 lenght 20 mm   Adapdador de eje de 6 a 8 longitud 20mm   Металлический редуктор на 6 и на 8 мм длиной 20 мм
<b>RID6X8X30</b>	<b>Riduzione di ferro da 6 a 8 lunghezza 30 mm</b>   Metallic reduction from 6 to 8 lenght 30 mm   Adapdador de eje de 6 a 8 longitud 30mm   Металлический редуктор на 6 и на 8 мм длиной 30 мм
<b>RID7X8X30</b>	<b>Riduzione di ferro da 7 a 8 lunghezza 30 mm</b>   Metallic reduction from 7 to 8 lenght 30 mm   Adapdador de eje de 7 a 8 longitud 30mm   Металлический редуктор на 7 и на 8 мм длиной 30 мм
<b>RID8X8,5X28,5</b>	<b>Riduzione di ferro da 8 a 8,5 lunghezza 28,5 mm</b>   Metallic reduction from 8 to 8,5 lenght 28,5 mm   Adapdador de eje de 8 a 8,5 longitud 28,5 mm   Металлический редуктор на 8 и на 8,5 мм длиной 28,5 мм
<b>RID8X9X30</b>	<b>Riduzione di ferro da 8 a 9 lunghezza 30 mm</b>   Metallic reduction from 8 to 9 lenght 30 mm   Adapdador de eje de 8 a 9 longitud 30mm   Металлический редуктор на 8 и на 9 мм длиной 30 мм



## Condizioni generali di vendita

- 1 **ORDINI:** Brialma si riserva di accettare in tutto o in parte gli ordini che riceverà direttamente o tramite i propri agenti. Le quantità ordinate saranno arrotondate al multiplo superiore della confezione prevista.
- 2 **SPEDIZIONI:** La merce si intende sempre resa franco nostra fabbrica. La merce viaggia in ogni caso a rischio e pericolo del committente.
- 3 **CONSEGNE:** Il termine di consegna e di spedizione, anche se confermato, costituisce una semplice previsione ed ha perciò un valore indicativo, quindi non comporta nessuna garanzia e nessun indennizzo è dovuto per la mancata consegna nel termine previsto.
- 4 **PAGAMENTI:** i pagamenti devono essere effettuati al domicilio della nostra sede o presso la Banca indicata dalla stessa, entro e non oltre la scadenza concordata. Trascorso il termine stabilito saranno conteggiati interessi di mora. Il mancato pagamento autorizza Brialma a sospendere ulteriori invii di merce.
- 5 **RECLAMI E SOSTITUZIONI:** si accettano eventuali reclami se fatti pervenire entro 8 giorni dalla data di ricevimento della merce. Eventuali resi/sostituzioni devono essere effettuati previa nostra autorizzazione. Per eventuali articoli speciali o personalizzati non saranno accettati resi per nessun motivo.
- 6 **ARTICOLI:** Brialma di riserva la facoltà di apportare in qualunque momento modifiche ai prodotti presentati in questo catalogo, per ragioni interne e/o tecniche e/o commerciali, senza doverne dare preavviso alla clientela.
- 7 **FORO COMPETENTE:** per qualsiasi controversia è competente unico il Foro di Brescia.

## General terms and sales conditions

- 1 **ORDERS:** Brialma reserves to accept fully or partially all the orders received directly or through our salesmen or agents. The quantities ordered will be automatically rounded up to the superior multiple of the foreseen packaging.
- 2 **SHIPMENTS:** Even if goods are supplied free destination, they are forwarded at the exclusive risk of the buyer, who is obliged to collect them.
- 3 **DELIVERIES:** the delivery terms are not binding and are always to be considered approximate. In case of delay of delivery or in executing an order, Brialma will not be liable for damages.
- 4 **PAYMENTS:** all payments must be made within the terms agreed upon and exclusively to our domicile. After this term, we will debit interest for delay based on the legal interest rate. In case of missing or partial payment, Brialma is allowed to send no more goods.
- 5 **CLAIMS AND REPLACEMENTS:** Claims will only be accepted if received within 8 days from the date of receiving of goods. Returned goods without our prior approval are not allowed. In case of "customed" or special items, we will not accept the return of goods for any reason.
- 6 **PRODUCTS:** Brialma keeps the right to modify the features of any item for internal and/or technical and/or trade reasons, without providing any notice to the customers.
- 7 **COMPETENT LAW-COURT:** for any dispute, the competence belongs to the law-court of Brescia (Italy) only.

## Condiciones generales de venta

- 1 PEDIDOS: Brialma se reserva de aceptar en su totalidad o en parte los pedidos que recibirá directamente o a través de sus agentes. Se redondearán las cantidades pedidas a los múltiplos mayor que proporciona el embalaje.
- 2 EXPEDICIONES: La mercancía siempre con entrega EXW en nuestra fábrica. La mercancía viaja en todos casos a riesgo y peligro del cliente
- 3 ENTREGAS: el término de entrega y envío, incluso en caso de confirmarse, constituirá una simple previsión y por lo tanto tiene un valor aproximativo, por lo que no implica ninguna garantía y no se le debe compensación por la falta de entrega dentro del plazo establecido.
- 4 PAGOS: los pagos deben realizarse en el banco indicado por la misma, a más tardar en el plazo acordado. Después del plazo establecido serán aplicados intereses de demora. La falta de pago autoriza Brialma a suspender los envíos de mercancías.
- 5 QUEJAS Y REEMPLAZOS: se aceptan las quejas que serán presentadas dentro de los 8 días de la entrega de la mercancía. Cualquier devoluciones y sustituciones deben llevarse a cabo después de nuestra aprobación. Para los elementos especiales o personalizados no se aceptan devoluciones en ningún caso.
- 6 PRODUCTOS: Brialma se reserva el derecho de modificar, en cualquier momento, los productos presentados en este catálogo, por razones internas y/o técnicas y/o comerciales, sin previo aviso a los clientes.
- 7 JURISDICCION: cualquier controversia será resuelta por el Foro de Brescia.

## Общие условия продаж

- 1 ЗАКАЗЫ: BRIALMA может принять все или часть заказов, которые они получают непосредственно или через своих агентов. Заказанное количество будет округлено до кратного планируемого пакета.
- 2 ПОСТАВКИ: товары всегда поставляются Ex Works от фабрики. Покупатель несет все виды риска и все расходы по перемещению товара с территории завода до указанного места назначения.
- 3 ДОСТАВКА: Поставка и перевозка груза, даже если они будут подтверждены, будет представлять собой простое предупреждение и таким образом имеет ориентировочное значение, так что не дают никакой гарантии и компенсации не происходит из-за непоставки в течение установленного срока.
- 4 ОПЛАТА: Оплата должна быть произведена в Банке, указанном последней, не позднее согласованного срока. По истечении этого срока будут учитываться проценты по умолчанию. Неуплата разрешает BRIALMA приостановить дальнейшие поставки товаров.
- 5 ЖАЛОБЫ И ЗАМЕНЫ: принимать какие-либо претензии, если факты будут получены в течение 8 дней с момента получения товара. Любой возврат / замена должна быть произведена с нашего разрешения. В случае получения каких-либо специальных или выполненных на заказ предметов, последние не будут приняты обратно ни при каких обстоятельствах.
- 6 АРТИКУЛЫ: BRIALMA оставляет за собой право вносить в любое время изменения в продуктах, показанных в этом каталоге, по внутренним причинам и / или техническим и / или коммерческим, без предварительного уведомления клиентов.
- 7 КОМПЕТЕНТНЫЕ ОРГАНЫ: Любой спор будет разрешаться только в суде Брешии.

# Note

Notes | Notas | замечания

A series of horizontal dotted lines for writing notes.



A series of horizontal dotted lines for writing notes, spanning the width of the page.







**BRIALMA S.r.l.**

Produzione maniglie  
in alluminio anodizzato

Loc. Briale, 30  
25070 Casto (Brescia) Italia  
Tel. +39 0365 88181  
Fax +39 0365 899940  
info@brialma.com  
www.brialma.com