

didheya

for doors

essential accessories

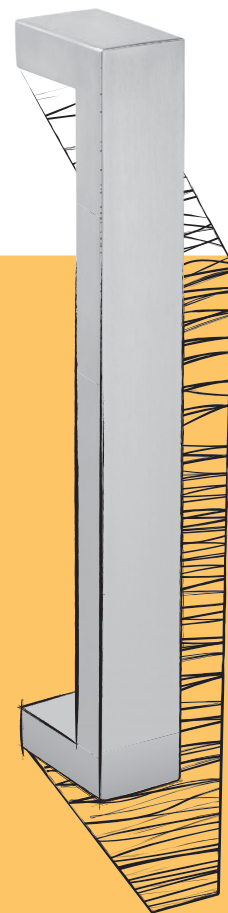



didheya

Tiradores encastrables
Flush pull handles
Poignées encastrées





i-3250



cod.	A	B	
53010	10	14	1
53012	12	16	1
53035	35	39	1
53040	40	44	1
53045	45	49	1
53050	50	54	1
53060	60	64	1

INOX MATE AISI 304

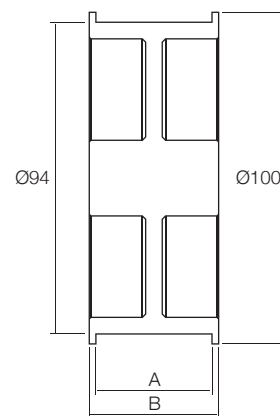
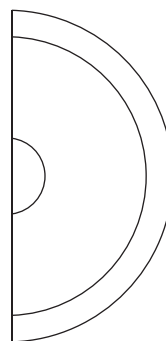

i-3250 WHITE



cod.	A	B		descripcion
53556	35	44	1	WHITE
53558	40	49	1	WHITE

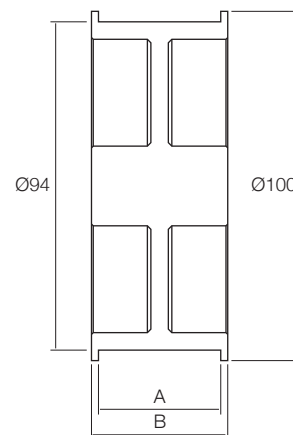
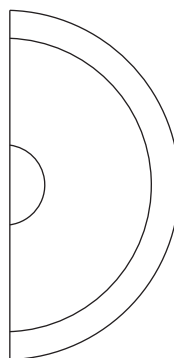

i-3250 BLACK



cod.	A	B		descripcion
53557	35	44	1	BLACK
53559	40	49	1	BLACK

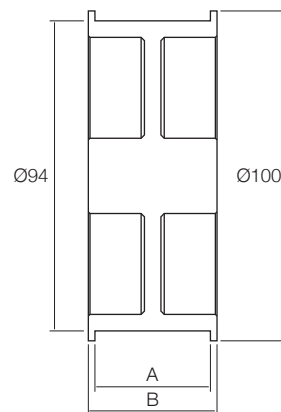
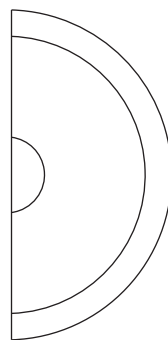

L-3250 ANTIQUE BRASS A6



cod.	A		descripcion
53661	35	1	ANTIQUÉ BRASS A6
53663	40	1	ANTIQUÉ BRASS A6

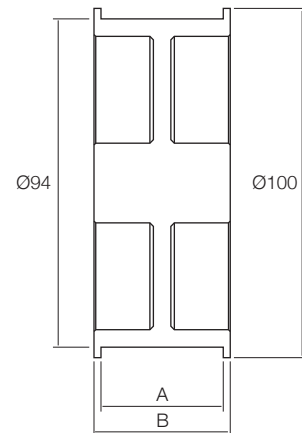
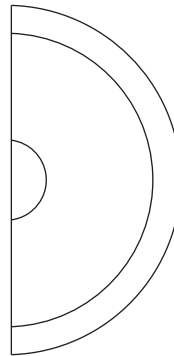

i-3250/1



cod  descripcion.

53100 1 INOX MATE

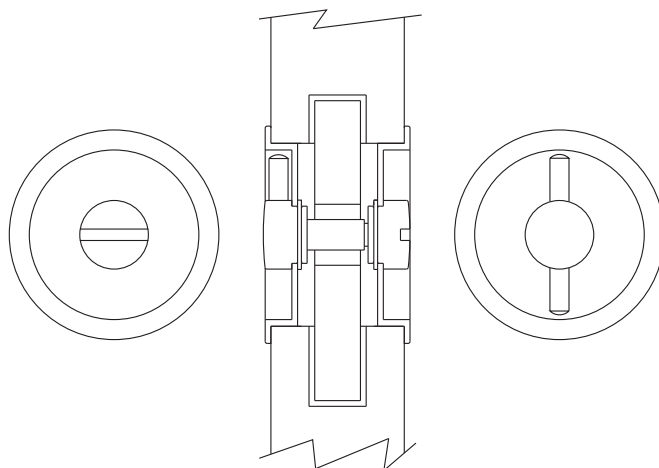
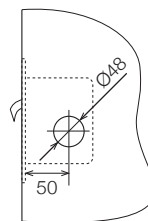

i-250



<u>cod</u>	<u>A</u>		<u>descripcion.</u>
31560	60	10	INOX MATE

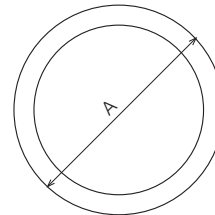
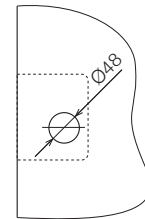



i-4250



cod.	A		descripcion.
53310	10	1	INOX MATE
53335	35	1	INOX MATE
53340	40	1	INOX MATE
53345	45	1	INOX MATE
53350	50	1	INOX MATE

KUBE

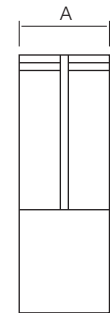
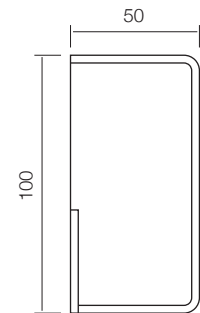

i-4250 WHITE



cod.	A		descripcion.
53606	35	1	WHITE
53608	40	1	WHITE

KUBE

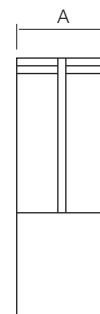
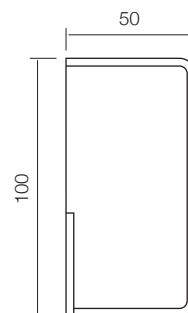

i-4250 BLACK



cod.	A		descripcion.
53607	35	1	BLACK
53609	40	1	BLACK

KUBE

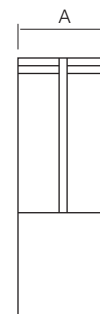
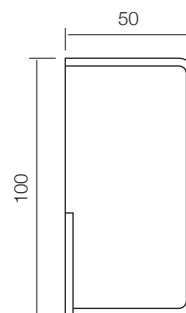



i-4251



cod.	X	Y	Z	
53701	35	120	55	1
53702	38	120	55	1
53703	40	120	55	1
53704	43	120	55	1
53705	50	120	55	1

INOX MATE AISI 304

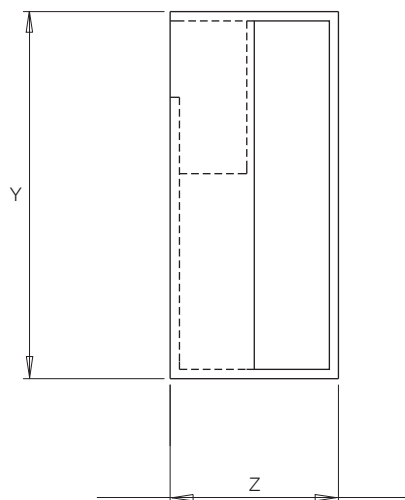
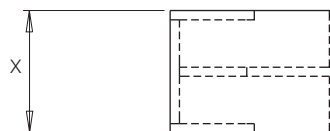



i- 4252



cod.	A		descripcion
------	---	---	-------------

53710	10	1	INOX MATE
-------	----	---	-----------

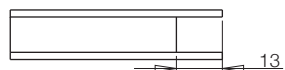
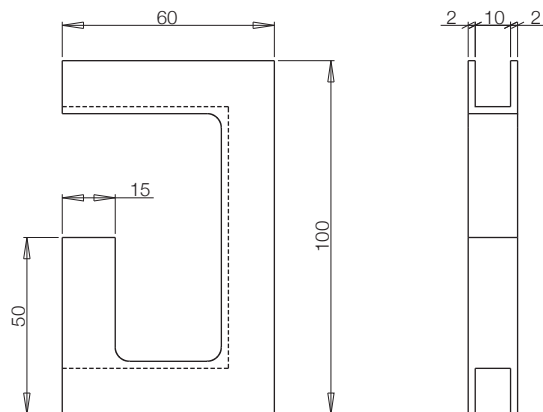

i- 4252 C



cod. A  descripcion

53711 10 1 INOX MATE

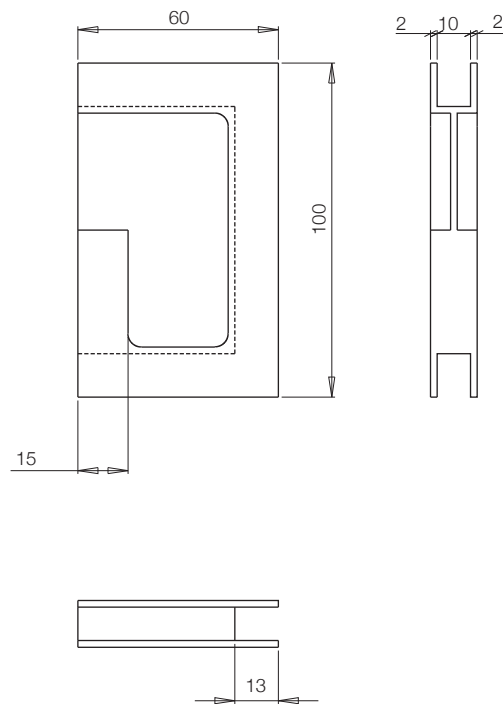

i- 4253



cod.	x	y	z	
53712	35	60	100	1
53713	38	60	100	1
53714	40	60	100	1
53715	43	60	100	1

INOX MATE

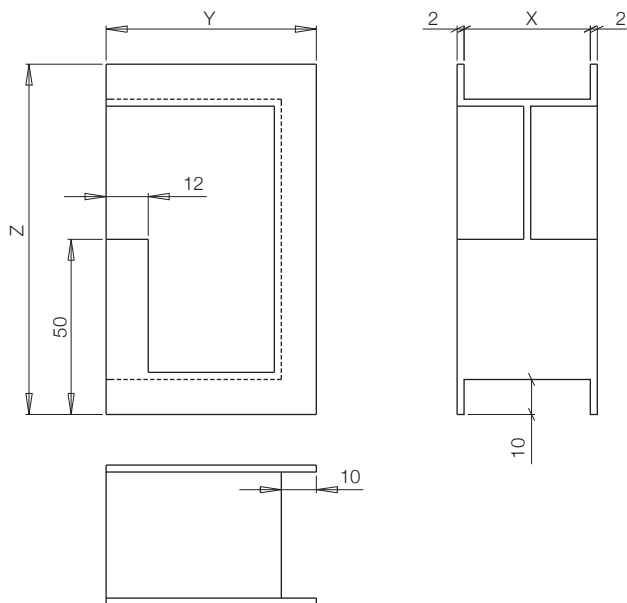





i- 4254



cod.	X	A	Z	Y	
53720	100	10	50	40	1
53721	100	35	50	40	1
53722	100	38	50	40	1
53723	100	40	50	40	1
53725	200	10	85	110	1
53726	200	35	85	110	1
53727	200	38	85	110	1
53728	200	40	85	110	1
53730	300	10	85	210	1
53731	300	35	85	210	1
53732	300	38	85	210	1
53733	300	40	85	210	1
53735	500	10	85	410	1
53736	500	35	85	410	1
53737	500	38	85	410	1
53738	500	40	85	410	1

INOX MATE

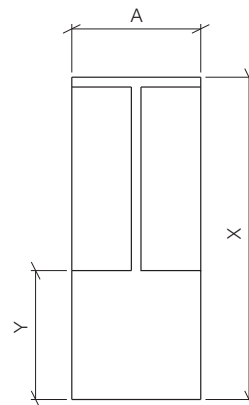
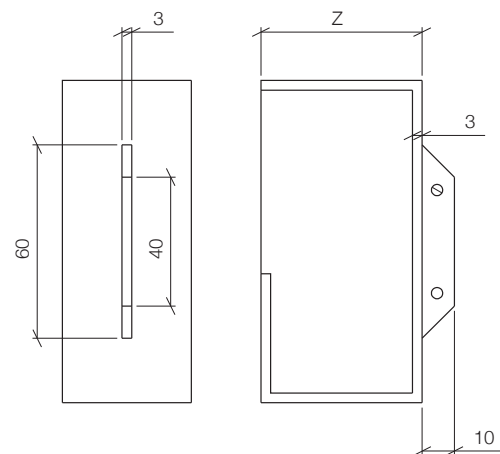

i-450

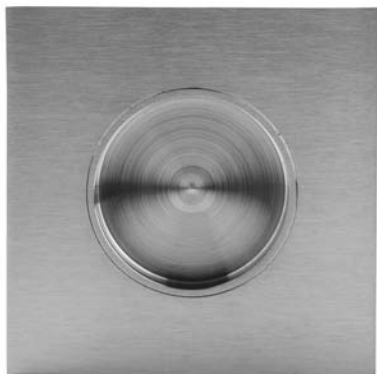

cod. 

53300 1

INOX MATE

KUBE

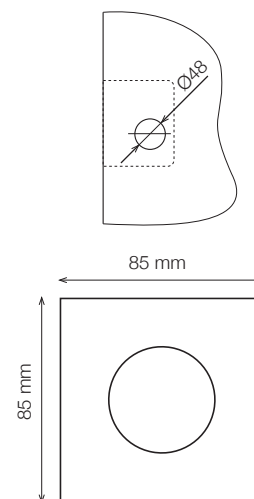

i-4250/1

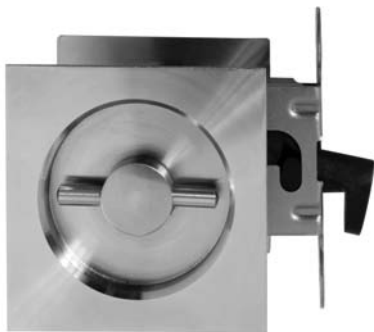

cod. 

53300 1

INOX MATE

KUBE

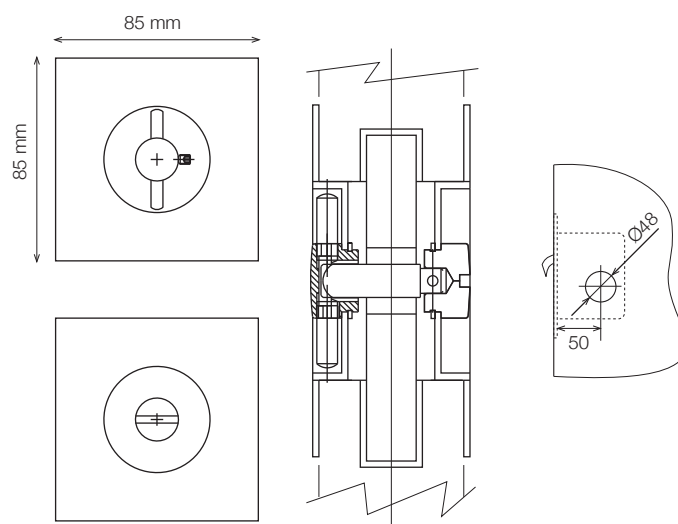





i- 5250



cod.	A		descripcion
53410	10	1	INOX MATE
53435	35	1	INOX MATE
53440	40	1	INOX MATE
53445	45	1	INOX MATE
53450	50	1	INOX MATE

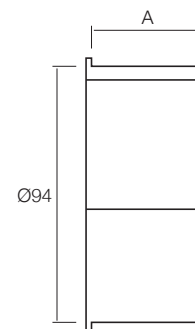
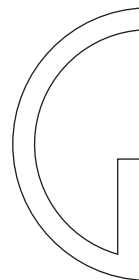



didheya

sly



i-4020





cod.	H1	H2	A1	A2	e		descripcion
53515	085	065	50	20	6	1set	INOX MATE
53516	150	130	65	35	6	1set	INOX MATE
53517	300	280	80	50	6	1set	INOX MATE

Set: 2 manillones + dedal / 2 handles + thimble

i-4030

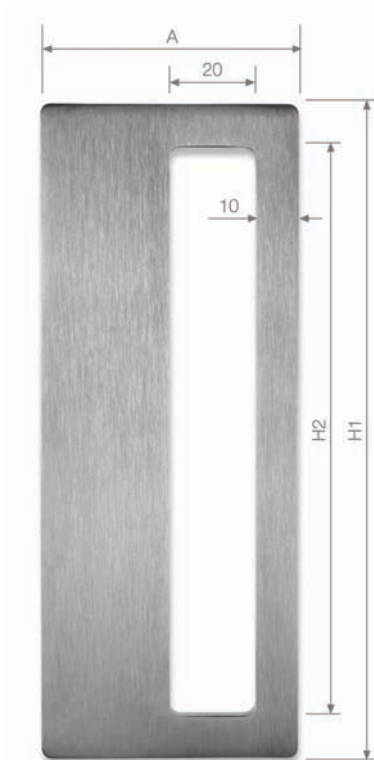
sly



cod.	H1	H2	A1	e		descripcion
53518	150	130	60	6	1set	INOX MATE
53519	300	280	75	6	1set	INOX MATE
53520	500	480	90	6	1set	INOX MATE

i-3010

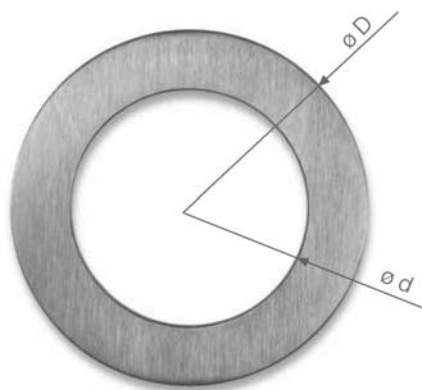

cod.	D	d	e		descripcion
53500	040	24	6	1set	INOX MATE
53501	070	46	6	1set	INOX MATE
53502	100	68	6	1set	INOX MATE

i-4010

sly

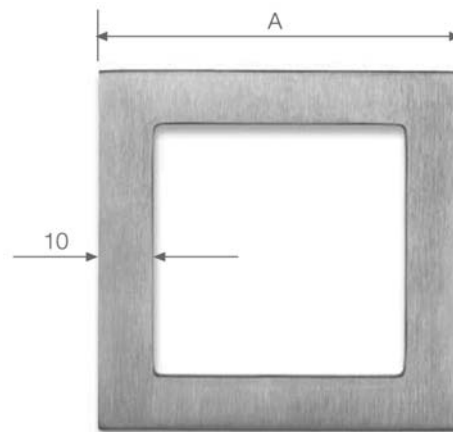

cod.	A	e		descripcion
53512	50	6	1set	INOX MATE
53513	65	6	1set	INOX MATE
53514	85	6	1set	INOX MATE



i-4040

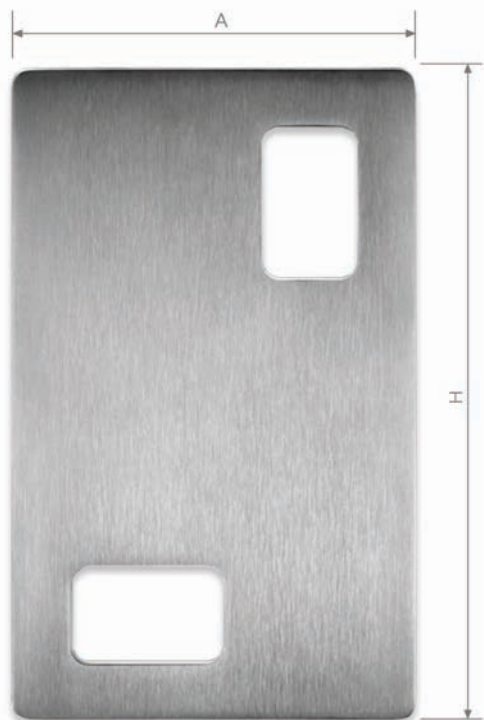

cod.	H	A	e		descripcion
53521	085	050	6	1set	INOX MATE
53522	150	092,71	6	1set	INOX MATE
53523	300	185,41	6	1set	INOX MATE

i-4050

sly

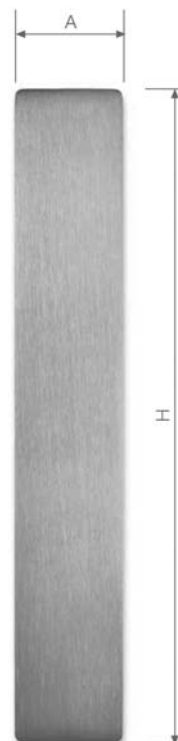



cod.	H	A	e		descripcion
53524	085	20	6	1set	INOX MATE
53525	150	25	6	1set	INOX MATE
53526	300	30	6	1set	INOX MATE

Set: 2 manillones + dedal / 2 handles + thimble

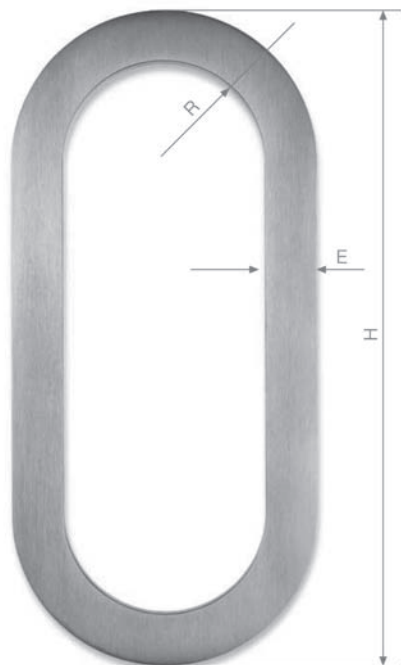

i-3020



cod.	R	H	E	e		descripcion
53503	20	085	8	6	1set	INOX MATE
53504	35	150	12	6	1set	INOX MATE
53505	50	300	16	6	1set	INOX MATE

i-4060

sly

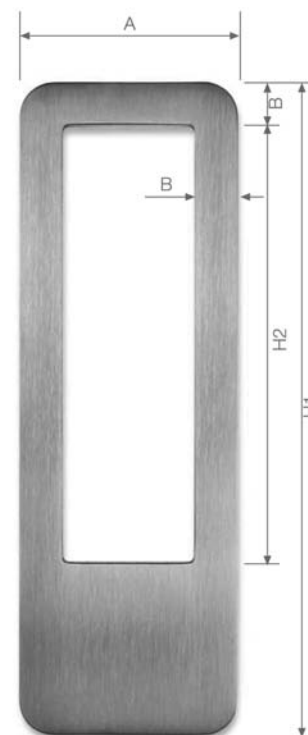



cod.	H1	H2	A	B	e		descripcion
53527	085	059	35	6	6	1set	INOX MATE
53528	150	100	50	10	6	1set	INOX MATE
53529	300	225	90	15	6	1set	INOX MATE

Set: 2 manillones + dedal / 2 handles + thimble

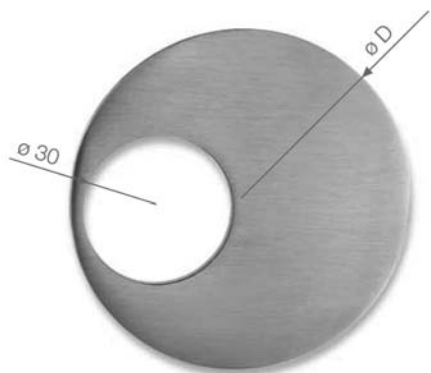

i-3030



cod.	D	e		descripcion
53506	040	6	1set	INOX MATE
53507	070	6	1set	INOX MATE
53508	105	6	1set	INOX MATE

i-3040

sly

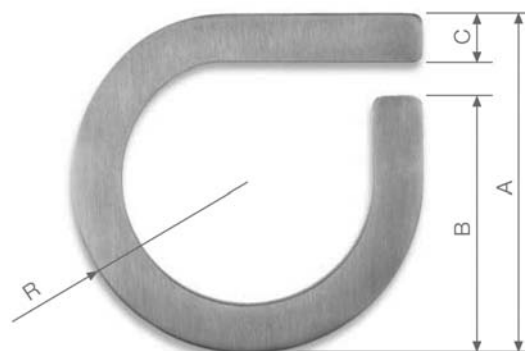

cod.	A	B	C	R	e		descripcion
53509	40	30	8	20	6	1set	INOX MATE
53510	70	60	10	35	6	1set	INOX MATE
53511	100	87,50	12	50	6	1set	INOX MATE

Set: 2 manillones + dedal / 2 handles + thimble



didheya

Tiradores de puerta
Pull handles
Bâton de maréchal

i-1000



cod.	∅	C	H	ext/set	
57420	40	200	65	ext	1
57520	40	200	65	int	1
44520	40	200	65	set	1
57430	40	300	65	ext	1
57530	40	300	65	int	1
44530	40	300	65	set	1
57450	40	500	65	ext	1
57550	40	500	65	int	1
44550	40	500	65	set	1

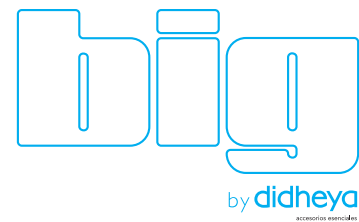

INOX MATE AISI 304

SET: EXT + INT + KIT 4

- A juego con i-100 pg.5 y serie Big Bath en pg.136-141 del catálogo general.
- Matches with ref. i-100 and Big Bath on page 136-141 of the general catalogue.
- Combine avec ref. i-100 et Big Bath sur la page 136-141 du catalogue general.

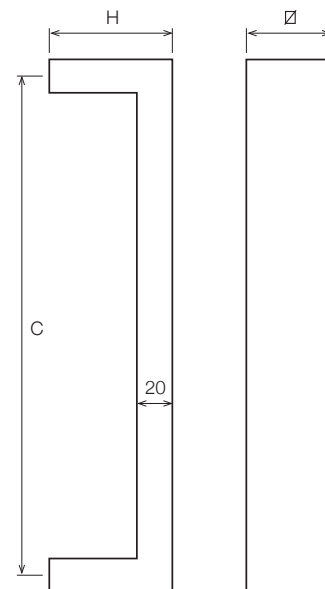

i-1260



cod.	∅	L		
53200	50	48	gir	1
53201	50	44	fix	1

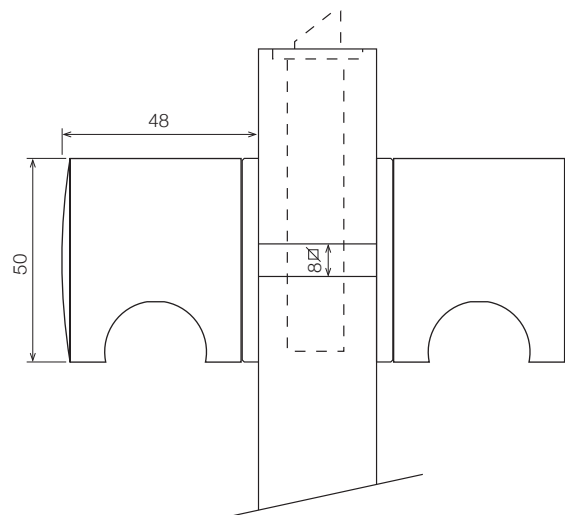

i-1310 Ø20-25-30



cod.	Ø	C	H	ext/set	
51015	20	150	55	ext	1
51115	20	150	55	int	1
42115	20	150	55	set	1
51020	20	200	55	ext	1
51120	20	200	55	int	1
42120	20	200	55	set	1
51025	20	250	55	ext	1
51125	20	250	55	int	1
42125	20	250	55	set	1
51030	20	300	55	ext	1
51130	20	300	55	int	1
42130	20	300	55	set	1
51220	25	200	70	ext	1
51320	25	200	70	int	1
42220	25	200	70	set	1
51225	25	250	70	ext	1
51325	25	250	70	int	1
42225	25	250	70	set	1
51230	25	300	70	ext	1
51330	25	300	70	int	1
42230	25	300	70	set	1
51425	30	250	90	ext	1
51525	30	250	90	int	1
42325	30	250	90	set	1
51430	30	300	90	ext	1
51530	30	300	90	int	1
42330	30	300	90	set	1
51435	30	350	90	ext	1
51535	30	350	90	int	1
42335	30	350	90	set	1
51445	30	450	90	ext	1
51545	30	450	90	int	1
42345	30	450	90	set	1
51460	30	600	90	ext	1
51560	30	600	90	int	1
42360	30	600	90	set	1

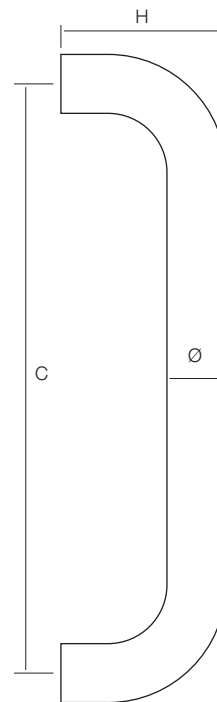

INOX MATE AISI 304

SET: EXT + INT + KIT 4

- A juego con i-131 pg.10 del catálogo general.
- Matches with ref. i-131 pg.10 of the general catalogue.
- Combine avec ref. i-131 pg.10 du catalogue general.

i-1630 Ø30



cod.	Ø	C	H	ext/set	
52025	30	250	66	ext	1
52125	30	250	66	int	1
45125	30	250	66	set	1
52030	30	300	70	ext	1
52130	30	300	70	int	1
45130	30	300	70	set	1
52035	30	350	74	ext	1
52135	30	350	74	int	1
45135	30	350	74	set	1
52045	30	450	80	ext	1
52145	30	450	80	int	1
45145	30	450	80	set	1
52060	30	600	80	ext	1
52160	30	600	80	int	1
45160	30	600	80	set	1

INOX MATE AISI 304

SET: EXT + INT + KIT 4

- A juego con tirador i-163 pg.12 del catálogo general.
- Matches with ref. i-163 pg.12 of the general catalogue.
- Combine avec ref. i-163 pg.12 du catalogue general.
- No apto para cristal.
- Not available for glass.
- Pas disponible pour porte en verre.

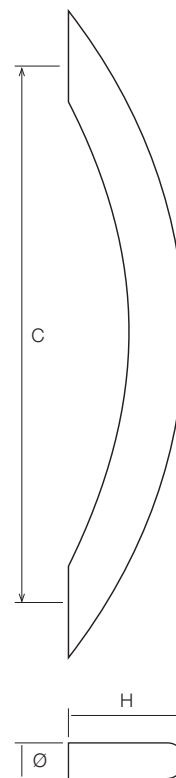



i-2000 Ø20



cod. Ø C H ext/set 

54020	20	200	300	ext	1
54120	20	200	300	int	1
43020	20	200	300	set	1
54025	20	250	400	ext	1
54125	20	250	400	int	1
43025	20	250	400	set	1
54030	20	300	450	ext	1
54130	20	300	450	int	1
43030	20	300	450	set	1
54050	20	500	700	ext	1
54150	20	500	700	int	1
43050	20	500	700	set	1

INOX MATE AISI 304

SET: EXT + INT + KIT 4

- A juego con tirador i-200 pg.13-14-15 del catálogo general.
- Matches with ref. i-200 pg.13-14-15 of the general catalogue.
- Combine avec ref. i-200 pg.13-14-15 du catalogue general.

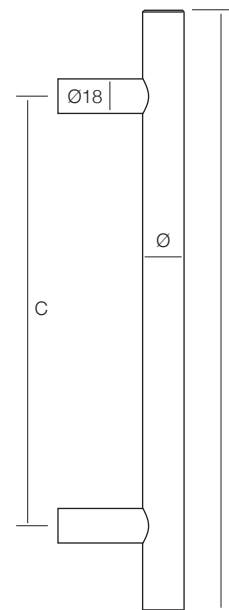

i-2000 Ø30



cod.	Ø	C	H	ext/set	
54225	30	250	550	ext	1
54325	30	250	550	int	1
43125	30	250	550	set	1
54230	30	300	600	ext	1
54330	30	300	600	int	1
43130	30	300	600	set	1
54235	30	350	650	ext	1
54335	30	350	650	int	1
43135	30	350	650	set	1
54245	30	450	750	ext	1
54345	30	450	750	int	1
43145	30	450	750	set	1
54260	30	600	900	ext	1
54360	30	600	900	int	1
43160	30	600	900	set	1
54265	30	650	950	ext	1
54365	30	650	950	int	1
43165	30	650	950	set	1

INOX MATE AISI 304

SET: EXT + INT + KIT 4

- A juego con tirador i-200 pg.13-14-15 del catálogo general.
- Matches with ref. i-200 pg.13-14-15 of the general catalogue.
- Combine avec ref. i-200 pg.13-14-15 du catalogue general.

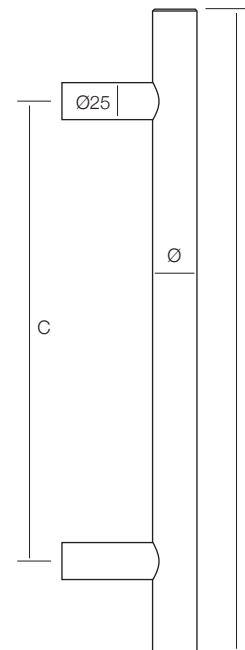

i-2700 Ø30



cod.	Ø	C	L	H	ext/set	
------	---	---	---	---	---------	---

54425	30	250	550	78	ext	1
54525	30	250	550	78	int	1
43325	30	250	550	78	set	1
54430	30	300	600	78	ext	1
54530	30	300	600	78	int	1
43330	30	300	600	78	set	1

INOX MATE AISI 304

SET: EXT + INT + KIT 4

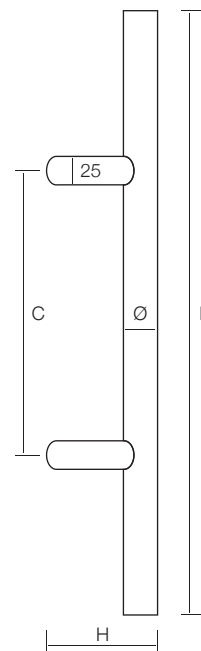
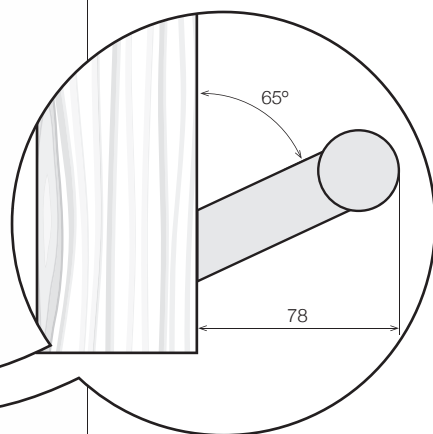



i-2630 Ø30



cod. Ø C L H ext/set 

52220	30	200	500	90	ext	1
52320	30	200	500	90	int	1
45220	30	200	500	90	set	1
52225	30	250	550	90	ext	1
52325	30	250	550	90	int	1
45225	30	250	550	90	set	1
52250	30	500	800	90	ext	1
52350	30	500	800	90	int	1
45250	30	500	800	90	set	1

INOX MATE AISI 304

SET: EXT + INT + KIT 4

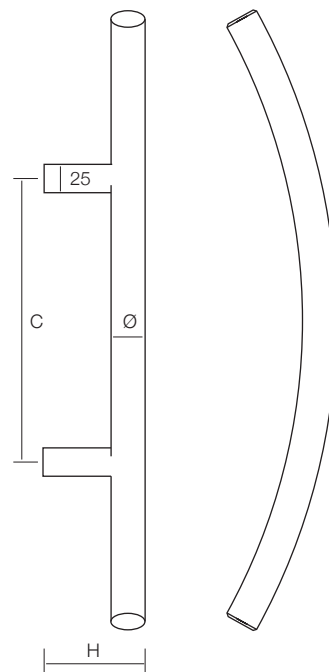

i-3310 Ø15-20-30



cod.	Ø	C	H	ext/set	
50015	15	150	55	ext	1
50115	15	150	55	int	1
42415	15	150	55	set	1
50020	15	200	55	ext	1
50120	15	200	55	int	1
42420	15	200	55	set	1
50030	15	300	55	ext	1
50130	15	300	55	int	1
42430	15	300	55	set	1
50220	20	200	65	ext	1
50320	20	200	65	int	1
42520	20	200	65	set	1
50225	20	250	65	ext	1
50325	20	250	65	int	1
42525	20	250	65	set	1
50230	20	300	65	ext	1
50330	20	300	65	int	1
42530	20	300	65	set	1
50425	30	250	90	ext	1
50525	30	250	90	int	1
42625	30	250	90	set	1
50430	30	300	90	ext	1
50530	30	300	90	int	1
42630	30	300	90	set	1
50435	30	350	90	ext	1
50535	30	350	90	int	1
42635	30	350	90	set	1
50460	30	600	90	ext	1
50560	30	600	90	int	1
42660	30	600	90	set	1

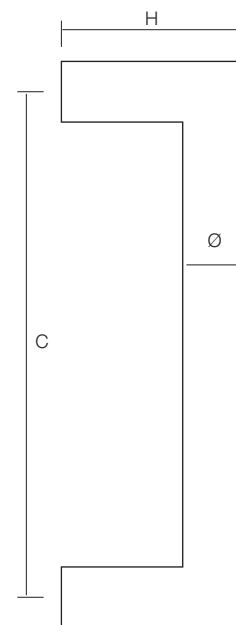

INOX MATE AISI 304

SET: EXT + INT + KIT 4

- A juego con tirador i-331 pg.20 del catálogo general.

- Matches with ref. i-331 pg.20 of the general catalogue.

- Combine avec ref. i-331 pg.20 du catalogue general.

i-3630 Ø30



cod.	Ø	C	H	ext/set	
52430	30	300	90	ext	1
52530	30	300	90	int	1
45430	30	300	90	set	1
52450	30	500	90	ext	1
52550	30	500	90	int	1
45450	30	500	90	set	1

INOX MATE AISI 304

SET: EXT + INT + KIT 4

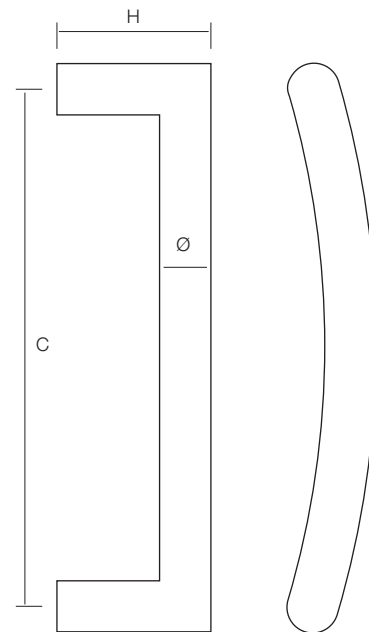

i-3330 Ø30



cod.	Ø	C	H	ext/set	
50830	30	300	90	ext	1
50930	30	300	90	int	1
42830	30	300	90	set	1
50850	30	500	90	ext	1
50950	30	500	90	int	1
42850	30	500	90	set	1

INOX MATE AISI 304

SET: EXT + INT + KIT 4

- A juego con tirador i-333 pg.22 del catálogo general.
- Matches with ref. i-333 pg.22 of the general catalogue.
- Combine avec ref. i-333 pg.22. du catalogue general.



i-4000 Ø20-30



cod.	Ø	Ø	C	L	H	ext/set	
57020	20	18	200	300	65	ext	1
57120	20	18	200	300	65	int	1
44320	20	18	200	300	65	set	1
57025	20	18	250	400	65	ext	1
57125	20	18	250	400	65	int	1
44325	20	18	250	400	65	set	1
57030	20	18	300	450	65	ext	1
57130	20	18	300	450	65	int	1
44330	20	18	300	450	65	set	1
57230	30	25	300	600	90	ext	1
57330	30	25	300	600	90	int	1
44430	30	25	300	600	90	set	1
57235	30	25	350	650	90	ext	1
57335	30	25	350	650	90	int	1
44435	30	25	350	650	90	set	1
57250	30	25	500	800	90	ext	1
57350	30	25	500	800	90	int	1
44450	30	25	500	800	90	set	1
57260	30	25	600	900	90	ext	1
57360	30	25	600	900	90	int	1
44460	30	25	600	900	90	set	1

INOX MATE AISI 304

SET: EXT + INT + KIT 4

- A juego con tirador i-400 pg.26 y pomo i-426 pg.55 del catálogo general.
- Matches with handle i-400 pg. 26 and knob i-426 pg.55 of the general catalogue.
- Combine avec poignée i-400 pg.26 et bouton i-426 pg.55 du catalogue general.

KUBE

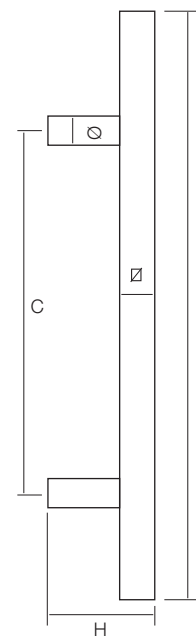

i-4400 Ø15-20-30



cod.	Ø	C	H	ext/set	
58015	15	150	55	ext	1
58115	15	150	55	int	1
44015	15	150	55	set	1
58020	15	200	55	ext	1
58120	15	200	55	int	1
44020	15	200	55	set	1
58030	15	300	55	ext	1
58130	15	300	55	int	1
44030	15	300	55	set	1
58220	20	200	65	ext	1
58320	20	200	65	int	1
44120	20	200	65	set	1
58225	20	250	65	ext	1
58325	20	250	65	int	1
44125	20	250	65	set	1
58230	20	300	65	ext	1
58330	20	300	65	int	1
44130	20	300	65	set	1
58425	30	250	90	ext	1
58525	30	250	90	int	1
44225	30	250	90	set	1
58430	30	300	90	ext	1
58530	30	300	90	int	1
44230	30	300	90	set	1
58435	30	350	90	ext	1
58535	30	350	90	int	1
44235	30	350	90	set	1
58460	30	600	90	ext	1
58560	30	600	90	int	1
44260	30	600	90	set	1

INOX MATE AISI 304

SET: EXT + INT + KIT 4

KUBE

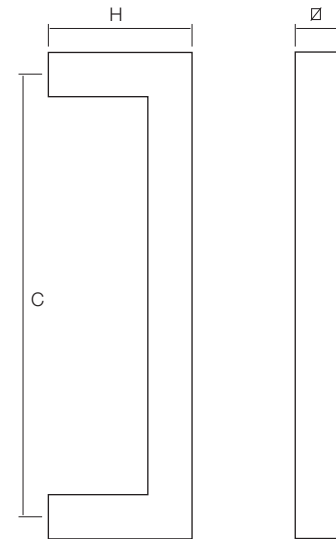

- A juego con tirador i-440 pg.27 y pomo i-410 pg.55 del catálogo general.

- Matches with handle i-440 pg.27 and knob i-410 pg.55 of the general catalogue.

- Combine avec poignée i-440 pg.27 et bouton i-410 pg.55 du catalogue general.

i-3290

Link It

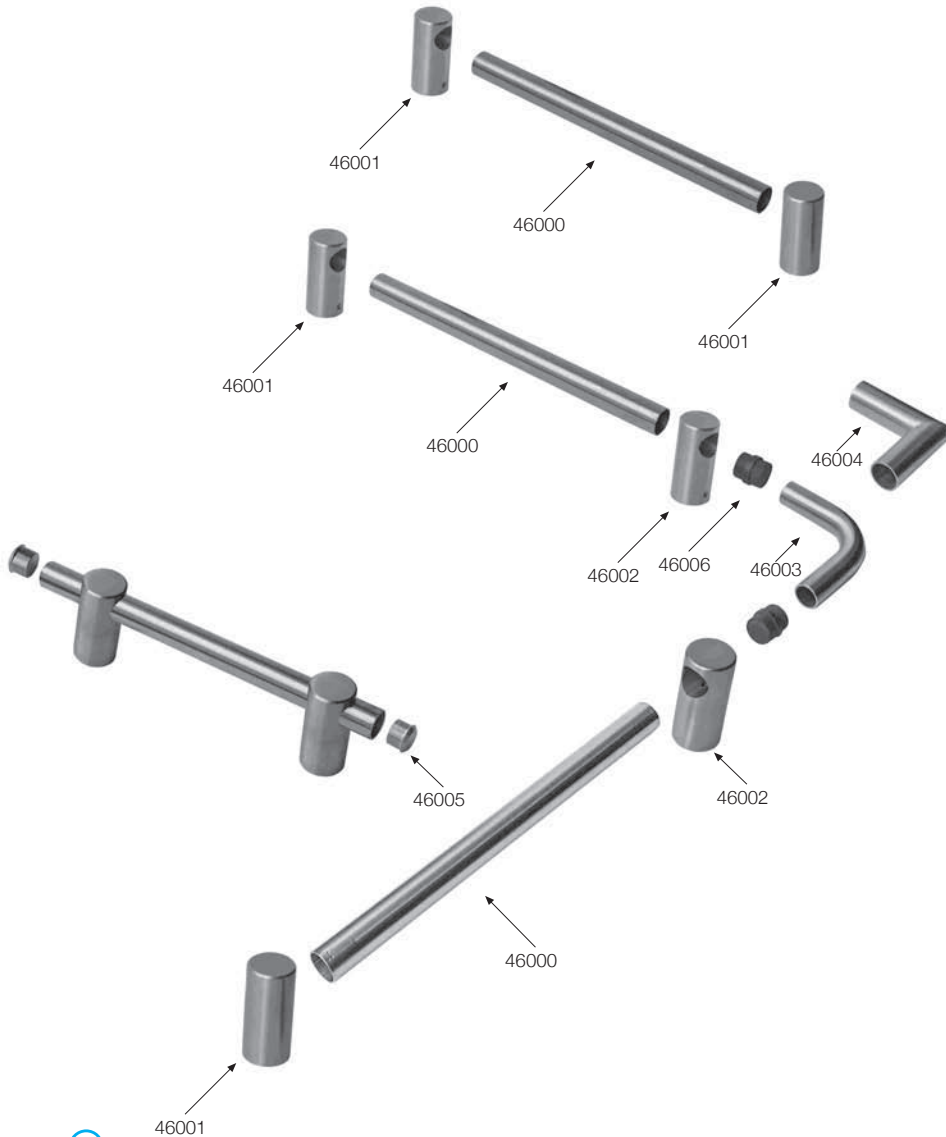

Construya su propio manillón, toallero, soporte de pasamanos o barra para cortinas adaptándolo a la medida deseada.

Make your own pull handle, towel rack, handrail or curtain rail, at any required size.

Construire votre bâton de maréchal, support serviette, main courante ou tringle à rideaux, à la mesure désirée.

cod.	descripción	
46000	I-3290 Tube 2Mts. 20mm. SS. Tubo Inox Mate	5
46007	I-3290 Tube 3Mts. 20mm. SS. Tubo Inox Mate	5
46001	I-3290 Bracket 30mm. SS. Terminal Inox Mate	14
46002	I-3290 Center bracket 30mm. SS. Soporte central	14
46003	I-3290 90° Curve Angle SS. Ángulo curvo Inox Mate	4
46004	I-3290 90° Straight Angle SS. Ángulo recto	4
46005	I-3290 20mm. End cap SS. Tapón Inox Mate	20
46006	I-3290 20mm. nylon connector.Unión nylon 20 mm.	20

i-4290

Link It

Construya su propio manillón, toallero, soporte de pasamanos o barra para cortinas adaptándolo a la medida deseada.

Make your own pull handle, towel rack, handrail or curtain rail, at any required size.

Construire votre bâton de maréchal, support serviette, main courante ou tringle à rideaux, à la mesure désirée.

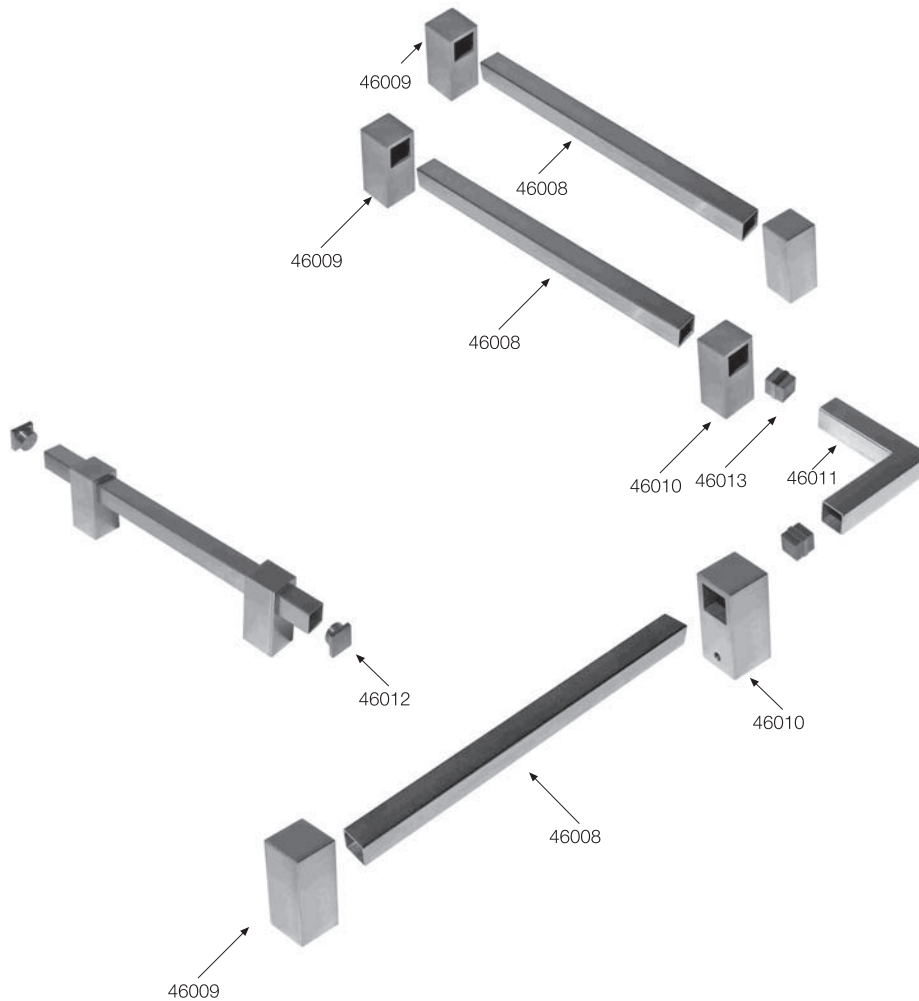

cod.	descripción	
46008	I-4290 Tube 2Mts. 20mm. SS. Cuadrado Inox Mate	5
46014	I-4290 Tube 3Mts. 20mm. SS. Cuadrado Inox Mate	5
46009	I-4290 Bracket 30mm. SS. Terminal Inox Mate	14
46010	I-4290 Center Bracket 30mm. SS. Soporte central	14
46011	I-4290 90° Straight Angle SS. Ángulo recto	4
46012	I-4290 20mm. End cap SS. Tapón Inox Mate	20
46013	I-4290 20mm. nylon connector. Unión nylon 20 mm. 20	

z-4560

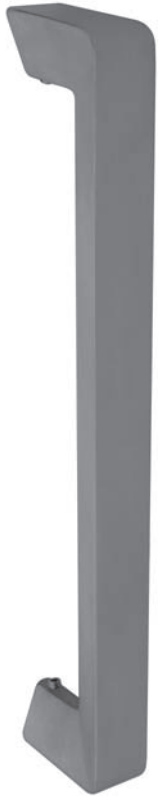

cod.	C	Descripción	
88710	200	26 Cromo Brillo	10
88711	200	02 Cromo Look	10
88712	200	15 Niquel Satinado	10
88713	200	04 Blanco Soft	10
88714	200	05 Negro Soft	10
88715	200	42 Cromo Mate	10
88716	200	A6 Latón Antiguo	10

Tirador para puertas ligeras y correderas.
Pull handle for sliding and light doors.
Poignée pour portes légères et coulissantes.

Incluye sistema de fijación universal.
Universal fixing system is included.
Fixation universel est incluse.

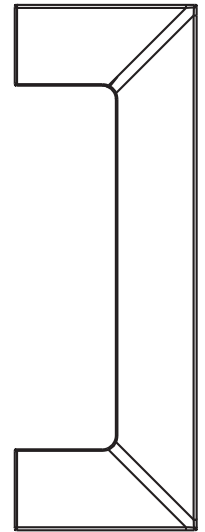
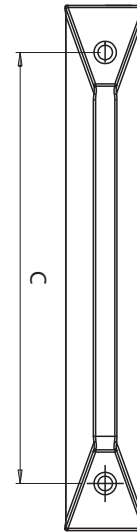

- A juego con tirador Tri z-456 pg.35 del catálogo general.
- Matches with handle Tri z-456 pg.35 of the general catalogue.
- Combine avec poignée Tri z-456 pg.35 du catalogue general.



Kits de fijación para manillones/Fixing kits/Kits de fixation

kit asidero simple a puerta de madera / cristal
bolt-through for wood / glass doors
kit fixation tirant simple pour porte en bois / verre



Cod	Descripción	Ø Taladro cristal	Modelos
94502	KIT - 2 / ø 15 mm M5	10 mm	I-3310 Ø 15
94507	KIT - 2 / □ 15 mm M5	10 mm	I-4400 Ø 15
94002	KIT - 2 / ø 20 mm M6	10 mm	I-1310 Ø20 / I-2000 Ø20 / I-3310 Ø20 / I-4000 Ø20
94302	KIT - 2 / □ 20 mm M6	10 mm	I-1000 / I-4400 Ø20
94102	KIT - 2 / ø 25 mm M8	12 mm	I-1310 Ø 25
94202	KIT - 2 / ø 30 mm M8	12 mm	I-1310 / I-1630 / I-2000 / I-2630 / I-2700 / I-3310 / I-3630 / I-4000 / I-3330
94402	KIT - 2 / □ 30 mm M8	12 mm	I-4400 Ø30

kit asidero doble a puerta de madera / cristal
back-to-back for wood / glass doors
kit fixation tirant double pour porte en bois / verre



Cod	Descripción	Ø Taladro cristal	Modelos
94504	KIT - 4 / ø 15 mm M5	10 mm	I-3310 Ø 15
94509	KIT - 4 / □ 15 mm M5	10 mm	I-4400 Ø 15
94004	KIT - 4 / ø 20 mm M6	10 mm	I-1310 Ø20 / I-2000 Ø20 / I-3310 Ø20 / I-4000 Ø20
94304	KIT - 4 / □ 20 mm M6	10 mm	I-1000 / I-4400 Ø20
94104	KIT - 4 / ø 25 mm M8	12 mm	I-1310 Ø 25
94204	KIT - 4 / ø 30 mm M8	12 mm	I-1310 / I-1630 / I-2000 / I-2630 / I-2700 / I-3310 / I-3630 / I-4000 / I-3330
94404	KIT - 4 / □ 30 mm M8	12 mm	I-4400 Ø30

kit asidero fijación pared / tornillo no pasante
wall fixing / front mounting
kit fixation mur / vis non transversant



Cod	Descripción	Modelos
94505	KIT - 5 / ø 15 mm	I-3310 Ø 15 / I-4400 Ø 15
94005	KIT - 5 / ø 20 mm	I-1310 Ø 20 / I-2000 Ø 20 / I-3310 Ø 20 / I-1000 / I-4400 Ø 20 / I-4000 Ø 20
94105	KIT - 5 / ø 25 mm	I-1310 Ø 25
94205	KIT - 5 / ø 30 mm	I-1310 / I-1630 / I-2000 / I-2630 / I-2700 / I-3310 / I-3630 / I-4000 / I-4400 / I-3330



Tel.: +34 943 610 052
Fax: +34 943 610 173

info@didheya.es
www.didheya.com

Ezurriki kalea E-20
E-20305 Irun, Spain.