

didheya

essential accessories

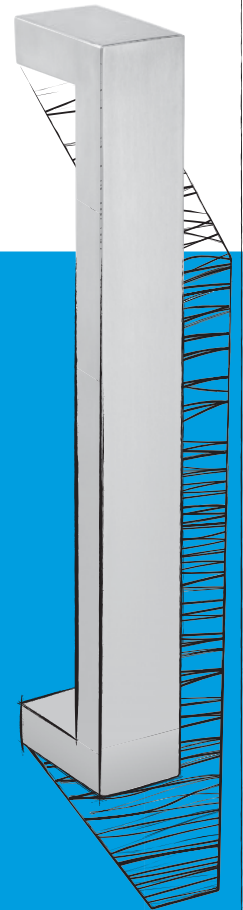

asas	handles <i>poignées</i>	03
	acero inoxidable / stainless steel / inox	
	zamak	
	aluminio / aluminium / aluminium	
pomos	knobs <i>boutons</i>	45
	acero inoxidable / stainless steel / inox	
	zamak	
tiradores de puerta, topes, soportes pasamanos		
	pull handles, door stoppers, handrail fittings	
	<i>bâton de maréchal, buttoirs de porte, support de main courante</i>	59
	acero inoxidable / stainless steel / inox	
	zamak	
tiradores de puertas correderas		79
	sliding door pull handles <i>tirant pour porte coulissante</i>	
	acero inoxidable / stainless steel / inox	
portaestantes shelf support <i>support tablette</i>		119
	acero inoxidable / stainless steel / inox	
	zamak	
separador de vidrio glass fitting <i>support verre</i>		123
	acero inoxidable / stainless steel / inox	
accesorios baño bathroom accessories <i>accessoires de bain</i>		125
	acero inoxidable / stainless steel / inox	
perchas hook & hook rack <i>patères</i>		150
	acero inoxidable / stainless steel / inox	
señalética signage <i>signalétique</i>		160
	acero inoxidable / stainless steel / inox	
índice de códigos index of codes <i>indice de codes</i>		166

asas
handles
poignées

AISI 303-304



i-100

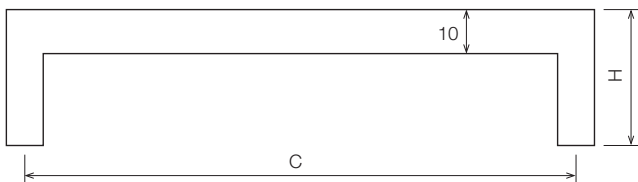
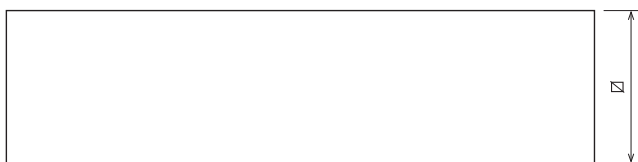

cod.	∅	C	H	
15001	40	016	40	10
15015	40	096	40	5
15020	40	128	40	5
15025	40	160	40	5
15030	40	192	40	5
15050	40	320	40	5
15080	40	512	40	5

INOX MATE AISI 304

- **Modelo de asa a juego con tirador de puerta i-1000 en la página 59 y serie Big Bath en página 136 - 141.**
- Furniture handle to match pull handle i-1000 on page 59 and Big Bath on page 136 - 141.
- *Même model de poignée que bâton de maréchal i-1000 sur la page 59 et Big Bath sur la page 136 - 141.*

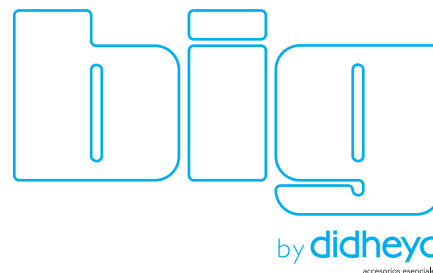

i-110

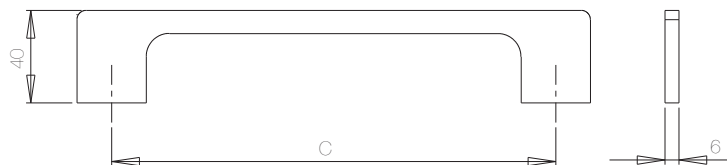
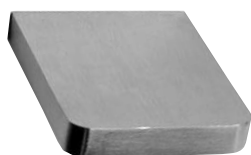



cod.	C	H	
24701	016	40	25
24715	096	40	25
24720	128	40	25
24725	160	40	25
24730	192	40	10
24750	320	40	10
24780	512	40	10

INOX MATE AISI 304

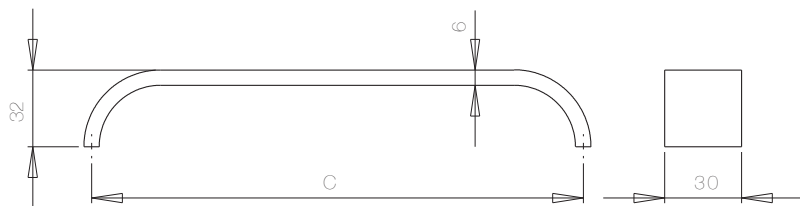
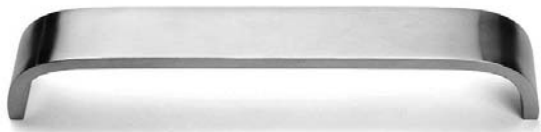

i-120





cod.	∅	C	H	
24601	40	016	32	25
24615	40	096	32	25
24620	40	128	32	25
24625	40	160	32	10
24630	40	192	32	10
24650	40	320	32	10
24680	40	512	32	10

INOX MATE AISI 304

flat
flat but deep

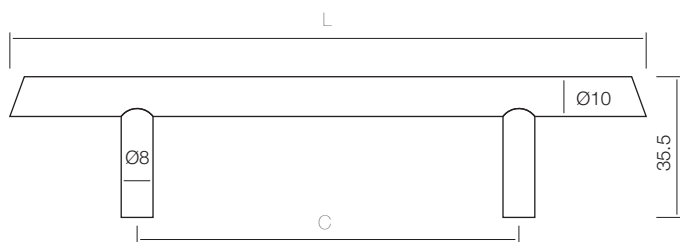
i-123



cod.	C	L	
20015	096	156	25
20020	128	188	25

INOX MATE AISI 304

i-128

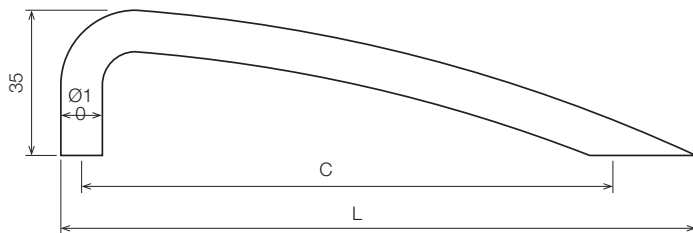

cod.	C	L	
20115	096	118	25
20120	128	153	25
20125	160	196	25

INOX MATE AISI 304

i-131 Ø8-10

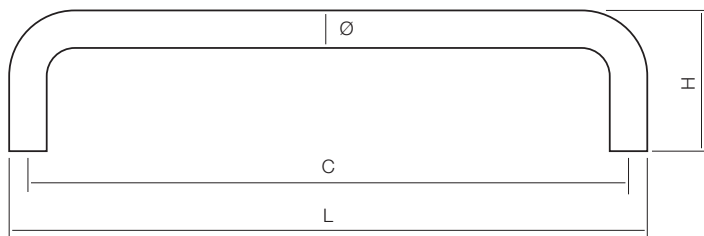

cod.	C	L	H		
Ø8	21010	064	072	30	25
	21015	096	104	30	25
	21020	128	136	30	25
	21025	160	168	30	25
	21030	192	200	30	25
Ø10	21110	064	074	35	25
	21115	096	106	35	25
	21120	128	138	35	25
	21125	160	170	35	25
	21130	192	202	35	25
	21135	224	234	35	10
	21140	256	266	35	10
	21145	288	298	35	10
	21150	320	330	35	10
	21155	352	362	35	10
	21165	416	426	35	10
	21180	512	522	35	10

INOX MATE AISI 304

- **Modelo de asa a juego con tirador de puerta i-1310 en la página 61.**

- Furniture handle to match pull handle i-1310 on page 61.

- *Même model de poignée que bâton de maréchal i-1310 sur la page 61.*

i-159

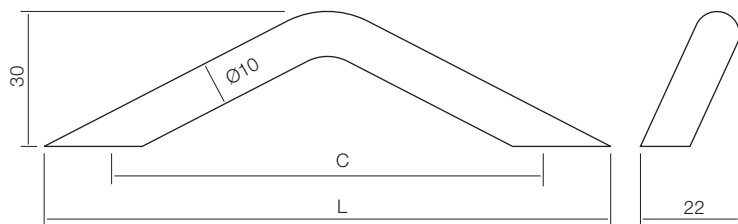

cod.	C	L	
22010	064	090	25
22015	096	126	25
22020	128	170	25

INOX MATE AISI 304

i-163 Ø10-12-14

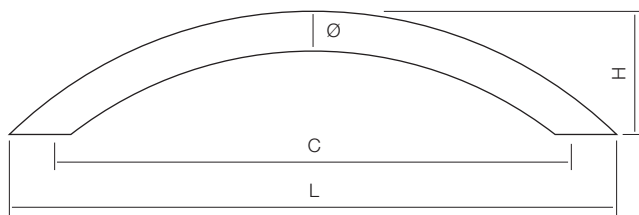

	cod.	C	L	H	
Ø10	23015	096	115	30,5	25
	23020	128	151	30,5	25
	23025	160	186	30,5	25
	23030	192	228	30,5	25
	23040	256	291	35	10
	23050	320	369	36	10
	23080	512	573	32	10

Ø12	23115	096	117	34	25
	23120	128	155	35	25
	23125	160	188	35	25
	23130	192	228	35	10

Ø14	23225	160	200	35	10
	23230	192	244	35	10
	23250	320	400	36	10

INOX MATE AISI 304

- **Modelo de asa a juego con tirador de puerta i-1630 en la página 62.**

- Furniture handle to match pull handle i-1630 on page 62.

- *Même model de poignée que bâton de maréchal i-1630 sur la page 62.*

i-200 Ø10

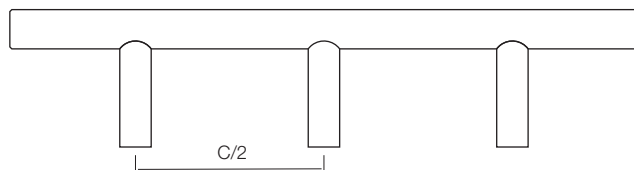
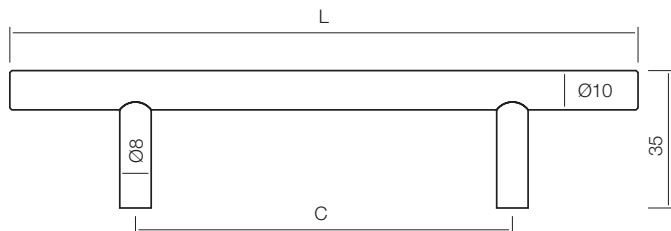

cod.	C	L	C/2	
10010	064	128		25
10015	096	160		25
10020	128	192		25
10025	160	224		25
10030	192	256		10
10035	224	288		10
10040	256	320		10
10045	288	352		10
10050	320	384		10
10055	352	416		10
10060	384	448		10
10065	416	480		10
10070	448	512		10
10075	480	544		10
10080	512	576		10
10085	544	608		10
10090	576	640		10
10095	608	672		10
10100	640	704	320	10
10105	672	736	336	10
10110	704	768	352	10
10115	736	800	368	10
10120	768	832	384	10
10125	832	896	384	10
10130	896	960	448	10
10135	960	1024	480	10
10140	1184	1248	592	10
10160	1376	1440	688	10

INOX MATE AISI 304

- **Modelo de asa a juego con tirador de puerta i-2000 en la página 63.**

- Furniture handle to match pull handle i-2000 on page 63.

- *Même model de poignée que bâton de maréchal i-2000 sur la page 63.*

i-200 Ø12

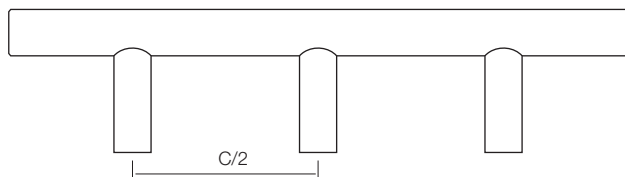
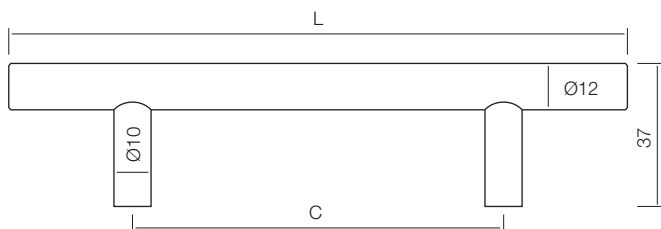

- Modelo de asa a juego con tirador de puerta i-2000 en la página 63-64.
- Furniture handle to match pull handle i-2000 on page 63-64.
- Même model de poignée que bâton de maréchal i-2000 sur la page 63-64.

cod.	C	L	C/2	
12010	064	128		25
12015	096	160		25
12020	128	192		25
12025	160	224		25
12030	192	256		10
12035	224	288		10
12040	256	320		10
12045	288	352		10
12050	320	384		10
12055	352	416		10
12060	384	448		10
12065	416	480		10
12070	448	512		10
12075	480	544		10
12080	512	576		10
12085	544	608		10
12090	576	640		10
12095	608	672		10
12100	640	704		10
12105	672	736		10
12110	704	768		10
12115	736	800	368	10
12120	768	832	384	10
12125	832	896	416	10
12130	896	960	448	10
12135	960	1024	480	10
12139	1152	1216	576	10
12140	1184	1248	592	10
12145	1280	1344	640	10
12160	1376	1440	688	10
12167	1408	1472	704	10
12172	1440	1504	720	10

INOX MATE AISI 304

i-200 Ø14

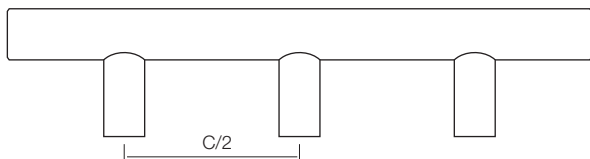
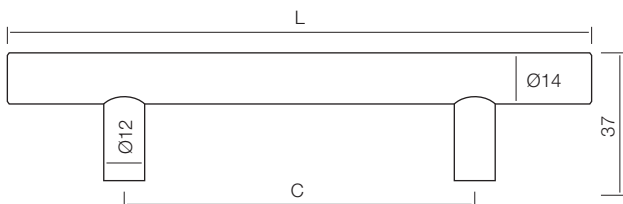

cod.	C	L	C/2	
14010	064	144		25
14015	096	176		25
14020	128	208		10
14025	160	240		10
14030	192	272		10
14035	224	304		10
14040	288	368		10
14050	320	400		10
14055	352	432		10
14060	384	464		10
14065	416	496		10
14075	480	560		10
14090	576	656		10
14100	640	720		10
14105	672	752		10
14115	736	816		10
14130	896	976		10
14135	960	1040		10
14139	1152	1232		10
14145	1280	1360	640	10
14167	1408	1488	704	10
14172	1440	1520	720	10

INOX MATE AISI 304

- **Modelo de asa a juego con tirador de puerta i-2000 en la página 63-64.**
- Furniture handle to match pull handle i-2000 on page 63-64.
- *Même model de poignée que bâton de maréchal i-2000 sur la page 63-64.*

kit i-200 Ø14



so 12

cod.	L	
------	---	---

93400	24	20
93401	50	20

INOX MATE AISI 304

Para convertir, tirador i-200 Ø14 como tirador de puerta o pequeño toallero.

To convert a handle i-200 Ø14 into a door pull handle or a towel rack.

Pour convertir poignée i-200 Ø14 comme poignée de porte ou petite porte-serviette.



cod.	ØD	L	
------	----	---	---

93200	12	40	20
-------	----	----	----

INOX MATE AISI 304

Para modelo i-200 Ø12

Only for i-200 Ø12

Pour model i-200 Ø12

edso

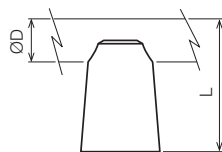

cod.	ØD	L	
------	----	---	---

93101	10	35	20
93102	12	37	20
93103	14	39	20

INOX MATE AISI 304

Para fijar a pared todas las i-200

To fit to the wall all i-200

Pour fixer au mur tous les modèles i-200

i-201

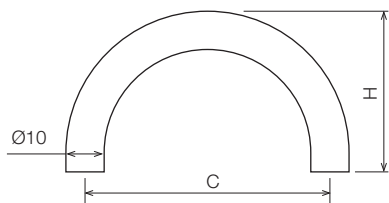

cod.	C	H	
22100	32	26	25
22101	32	40	25
22102	64	42	25

INOX MATE AISI 304

i-202

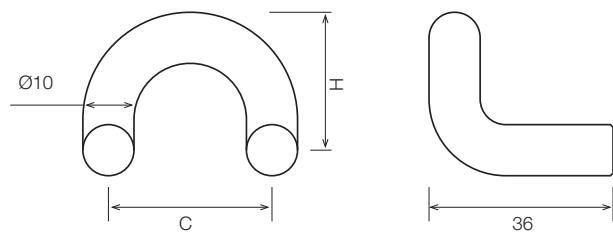



cod.	C	H	
------	---	---	---

22104	32	32	25
-------	----	----	----

INOX MATE AISI 304

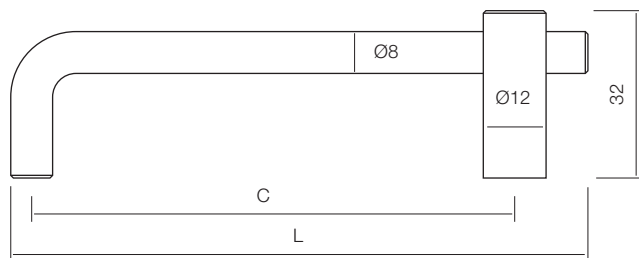
i-205



cod.	C	L	
22210	064	083	25
22215	096	118	25
22220	128	152	25

INOX MATE AISI 304

i-331 Ø12

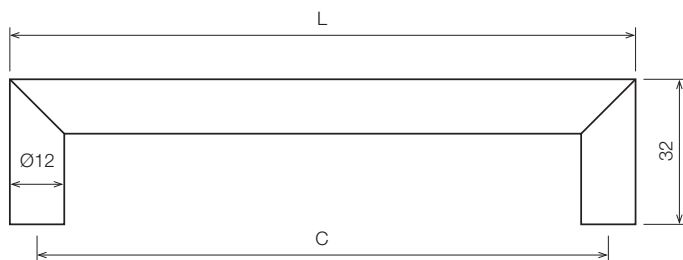

cod.	C	L	
24115	096	108	25
24120	128	140	25
24125	160	172	25
24130	192	204	10
24145	288	300	10
24150	320	332	10
24160	384	396	10
24175	480	492	10
24196	736	748	10

INOX MATE AISI 304

- **Modelo de asa a juego con tirador de puerta i-3310 en la página 67.**

- Furniture handle to match pull handle i-3310 on page 67.

- *Même model de poignée que bâton de maréchal i-3310 sur la page 67.*

i-331 Ø14

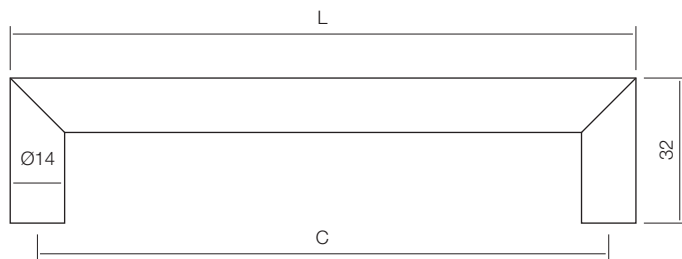

cod.	C	L	
27215	096	108	25
27220	128	142	25
27230	192	204	10
27253	342	356	10
27277	492	504	10
27294	592	606	10

TUBE INOX MATE AISI 304

- **Modelo de asa a juego con tirador de puerta i-3310 en la página 67.**

- Furniture handle to match pull handle i-3310 on page 67.

- *Même model de poignée que bâton de maréchal i-3310 sur la page 67.*

i-333

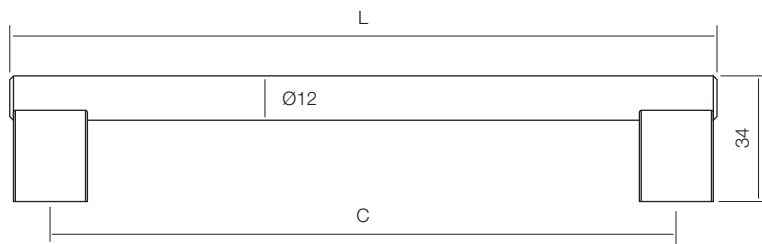

cod.	C	L	
24420	128	150	25
24425	160	182	25
24430	192	214	10
24446	292	314	10
24450	320	342	10
24453	342	364	10
24461	392	414	10
24477	492	514	10
24493	592	614	10
24497	792	814	10

INOX MATE AISI 304

- **Modelo de asa a juego con tirador de puerta i-3330 en la página 69.**
- Furniture handle to match pull handle i-3330 on page 69.
- *Même model de poignée que bâton de maréchal i-3330 sur la page 69.*



in-350

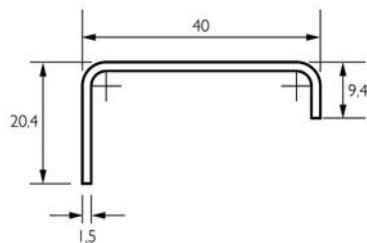
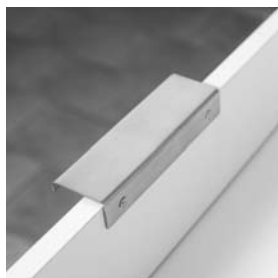
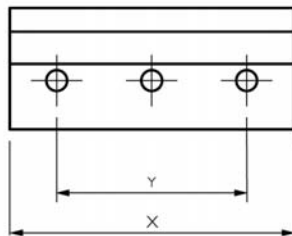
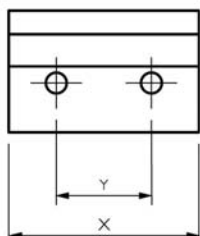

cod.	Y	X	
35005	016	032	25
35015	064	096	25
35020	096	128	25
35025	128	160	25
35030	160	192	10
35035	192	224	10
35040	224	256	10
35055	256	352	10
35085	352	544	10

INOX MATE AISI 304





i-400 Ø12

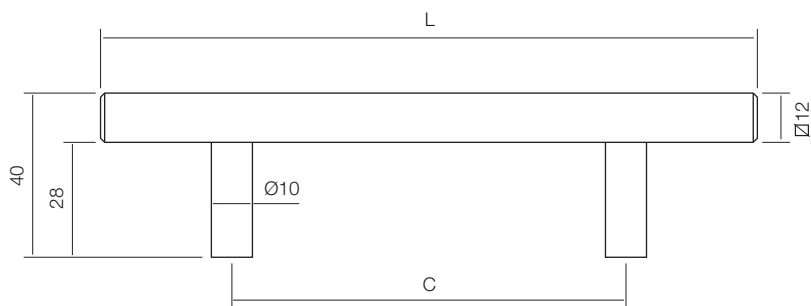

cod.	C	L	
12415	096	160	25
12420	128	192	25
12425	160	224	10
12430	192	256	10
12435	224	288	10
12440	256	320	10
12445	288	352	10
12450	320	384	10
12460	384	448	10
12475	480	544	10
12480	512	576	10
12500	640	704	10

INOX MATE AISI 304

- **Modelo de asa a juego con tirador de puerta i-4000 en la página 70 y pomo i-426 en la página 55.**
- Furniture handle to match pull handle i-4000 on page 70 and knob i-426 on page 55.
- *Même model de poignée que bâton de maréchal i-4000 sur la page 70 et bouton i-426 sur la page 55.*

KUBE

i-440 Ø12-15

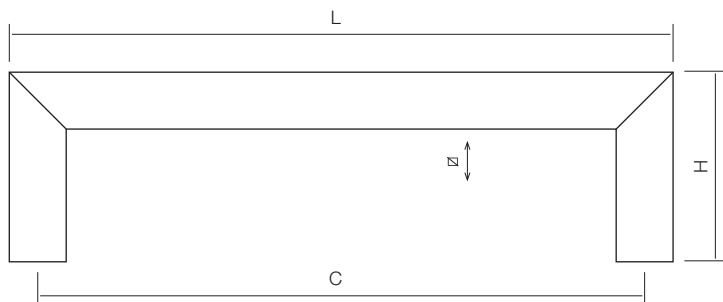

KUBE

cod.	C	L	H	
Ø12 26215	096	108	40	25
26220	128	140	40	25
26225	160	172	40	10
26230	192	204	40	10
26235	224	236	40	10
26250	320	332	40	10
26280	512	524	40	10
26296	612	624	40	10
26323	812	824	40	10

INOX MATE AISI 304

cod.	C	L	H	
Ø15 26420	128	143	45	10
26425	160	175	45	10
26430	192	207	45	5
26435	224	239	45	5
26450	320	335	45	5
26480	512	527	45	5

INOX MATE AISI 304

- **Modelo de asa a juego con tirador de puerta i-4400 en la página 71 y pomo i-410 en la página 55.**

- Furniture handle to match pull handle i-4400 on page 71 and knob i-410 on page 55.

- Môme model de poignée que bâton de maréchal i-4400 sur la page 71 et bouton i-410 sur la page 55.

z-0420



cod.	C	Descripción	
88640	032	26 Cromo Brillo	25
88630	096	26 Cromo Brillo	10
88620	192	26 Cromo Brillo	10
88642	032	15 Niquel Satinado	25
88632	096	15 Niquel Satinado	10
88622	192	15 Niquel Satinado	10
88645	032	42 Cromo Mate	25
88635	096	42 Cromo Mate	10
88625	192	42 Cromo Mate	10

 INLAY

z-0421



cod.	C	Descripción	
88590	016	26 Cromo Brillo	25
88580	032	26 Cromo Brillo	10
88570	064	26 Cromo Brillo	10
88592	016	15 Niquel Satinado	25
88582	032	15 Niquel Satinado	10
88572	064	15 Niquel Satinado	10
88595	016	42 Cromo Mate	25
88585	032	42 Cromo Mate	10
88575	064	42 Cromo Mate	10



z-450 z-457

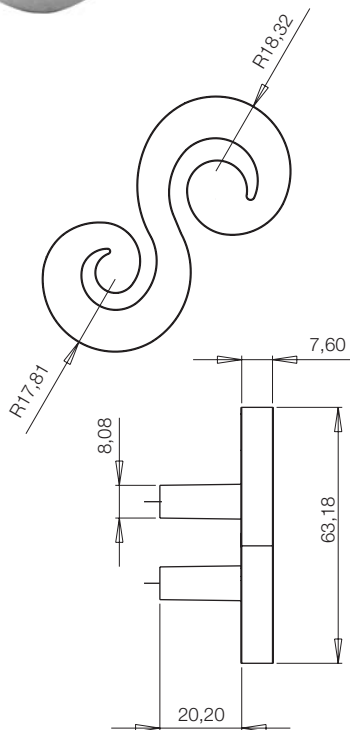
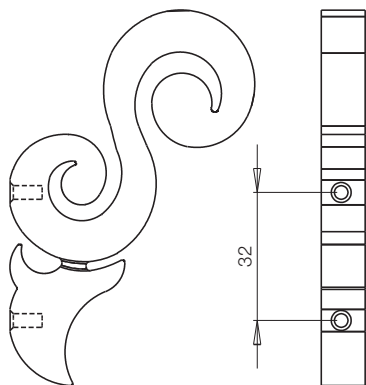
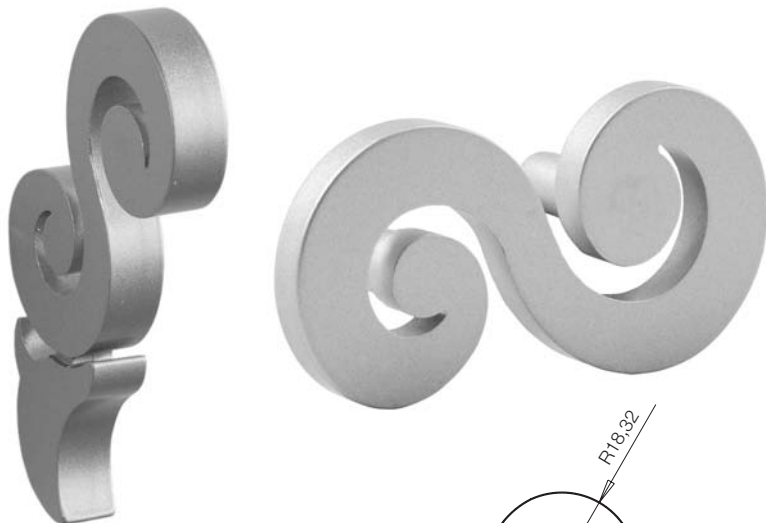



cod.	mm	Descripción	
70001	32	O2cromo look	10
70002	32	Fib Flocado Negro	10
70003	32	Wh Blanco	10
70000	32	A6 Latón Antiguo	10
70441	32	O2cromo look	10
70442	32	Fib Flocado Negro	10
70443	32	Wh Blanco	10
70440	32	A6 Latón Antiguo	10

ZAMAK

z-451

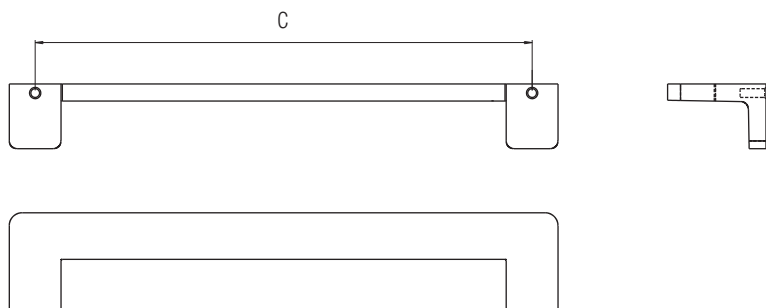
rounded zamak



cod.	C	Descripción	
70081	016	02 cromo look	25
70091	096	02 cromo look	10
70101	128	02 cromo look	10
70111	192	02 cromo look	10
70131	320	02 cromo look	10
70141	512	02 cromo look	10
70082	016	15 Niquel Satinado	25
70092	096	15 Niquel Satinado	10
70102	128	15 Niquel Satinado	10
70112	192	15 Niquel Satinado	10
70132	320	15 Niquel Satinado	10
70142	512	15 Niquel Satinado	10
70080	016	26 Cromo Brillo	25
70090	096	26 Cromo Brillo	10
70100	128	26 Cromo Brillo	10
70110	192	26 Cromo Brillo	10
70130	320	26 Cromo Brillo	10
70140	512	26 Cromo Brillo	10

ZAMAK

z-452

zamak Void

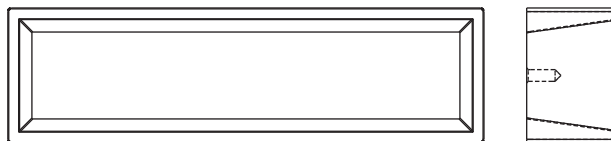
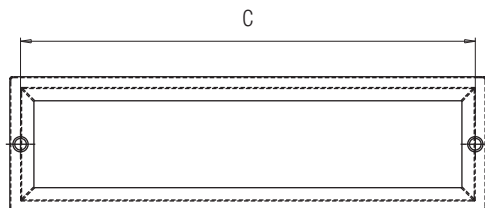



cod.	C	Descripción	
70151	032	02 cromo look	10
70161	096	02 cromo look	10
70171	128	02 cromo look	5
70181	192	02 cromo look	5
70201	320	02 cromo look	5
70211	512	02 cromo look	5
70152	032	15 Niquel Satinado	10
70162	096	15 Niquel Satinado	10
70172	128	15 Niquel Satinado	5
70182	192	15 Niquel Satinado	5
70202	320	15 Niquel Satinado	5
70212	512	15 Niquel Satinado	5
70154	032	Fib Flocado Negro	10
70164	096	Fib Flocado Negro	10
70174	128	Fib Flocado Negro	5
70184	192	Fib Flocado Negro	5
70204	320	Fib Flocado Negro	5
70214	512	Fib Flocado Negro	5

ZAMAK

z-453

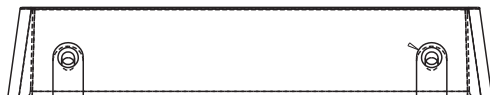
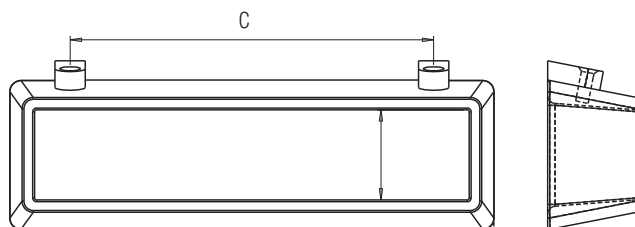
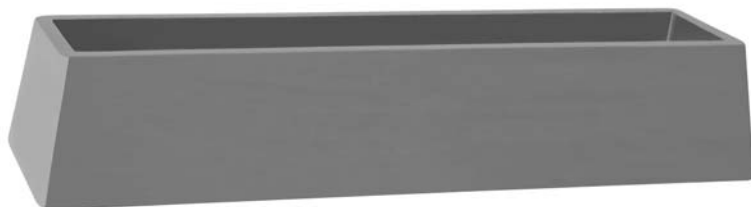
zamak
slash



cod.	C	Descripción	
70221	016	02 cromo look	10
70231	096	02 cromo look	10
70241	128	02 cromo look	10
70251	192	02 cromo look	5
70271	320	02 cromo look	5
70281	512	02 cromo look	5
70222	016	15 Niquel Satinado	10
70232	096	15 Niquel Satinado	10
70242	128	15 Niquel Satinado	10
70252	192	15 Niquel Satinado	5
70272	320	15 Niquel Satinado	5
70282	512	15 Niquel Satinado	5
70223	016	Wh Blanco	10
70233	096	Wh Blanco	10
70243	128	Wh Blanco	10
70253	192	Wh Blanco	5
70273	320	Wh Blanco	5
70283	512	Wh Blanco	5

ZAMAK



z-454

zamak
Switch

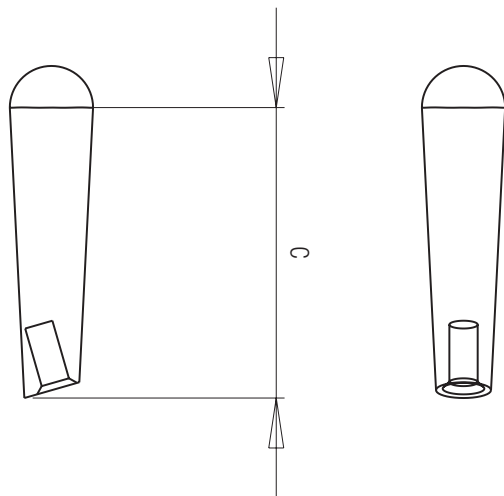

cod.	C	Descripción	
70290	40	26 Cromo Brillo	25
70291	40	02 Cromo Look	25
70292	40	15 Niquel Satinado	25

ZAMAK

z-455

zamak slope

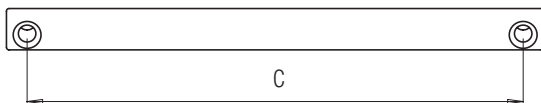
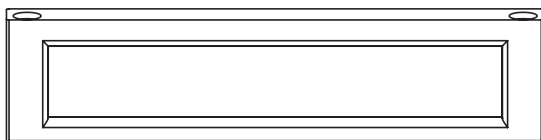

cod.	C	Descripción	
70300	032	26 Cromo Brillo	25
70310	096	26 Cromo Brillo	25
70320	128	26 Cromo Brillo	25
70330	192	26 Cromo Brillo	25
70350	320	26 Cromo Brillo	10
70360	512	26 Cromo Brillo	10
70301	032	02 Cromo Look	25
70311	096	02 Cromo Look	25
70321	128	02 Cromo Look	25
70331	192	02 Cromo Look	25
70351	320	02 Cromo Look	10
70361	512	02 Cromo Look	10
70302	032	15 Niquel Satinado	25
70312	096	15 Niquel Satinado	25
70322	128	15 Niquel Satinado	25
70332	192	15 Niquel Satinado	25
70352	320	15 Niquel Satinado	10
70362	512	15 Niquel Satinado	10

ZAMAK

z-456

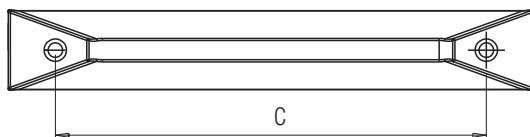
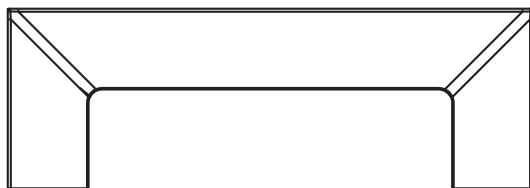

cod.	C	Descripción	
70381	096	02 Cromo Look	25
70391	128	02 Cromo Look	10
70401	192	02 Cromo Look	10
70421	320	02 Cromo Look	10
70431	512	02 Cromo Look	10
70382	096	15 Niquel Satinado	25
70392	128	15 Niquel Satinado	10
70402	192	15 Niquel Satinado	10
70422	320	15 Niquel Satinado	10
70432	512	15 Niquel Satinado	10
70380	096	26 Cromo Brillo	25
70390	128	26 Cromo Brillo	10
70400	192	26 Cromo Brillo	10
70420	320	26 Cromo Brillo	10
70430	512	26 Cromo Brillo	10

ZAMAK

- **Modelo de asa a juego con tirador de puerta z-4560 en la página 75.**
- Furniture handle to match pull handle z-4560 on page 75.
- *Même model de poignée que bâton de maréchal z-4560 sur la page 75.*



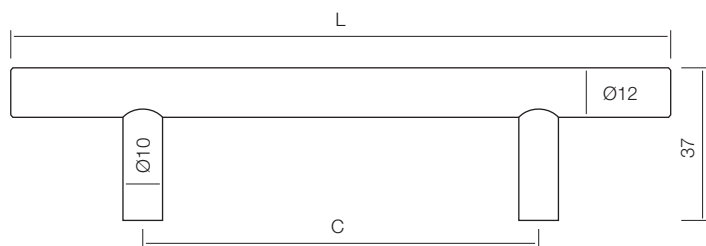

al-200 Ø12

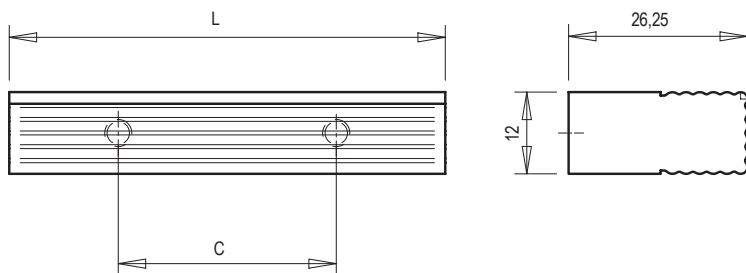
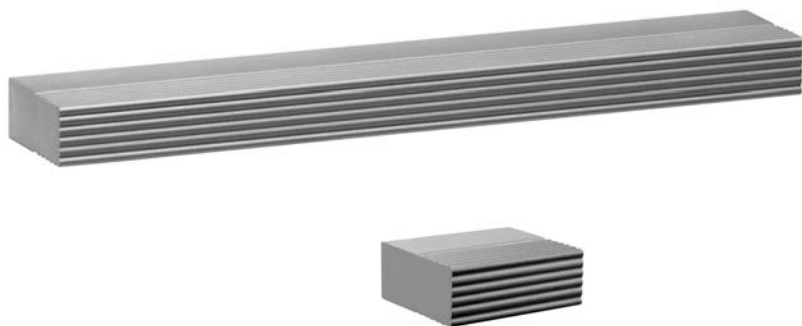

cod.	C	L	Descripción	
61215	096	160	ALUMINIO	25
61220	128	192	ALUMINIO	25
61225	160	224	ALUMINIO	10
61230	192	256	ALUMINIO	10
61235	224	288	ALUMINIO	10
61250	320	384	ALUMINIO	10

al-1



cod.	C	L	Descripción	
60101	016	032	ALUMINIO	25
60110	064	096	ALUMINIO	25
60115	096	128	ALUMINIO	25
60120	128	160	ALUMINIO	25
60125	160	192	ALUMINIO	10
60130	192	224	ALUMINIO	10
60135	224	256	ALUMINIO	10
60150	320	352	ALUMINIO	10
60180	512	544	ALUMINIO	10

al-2

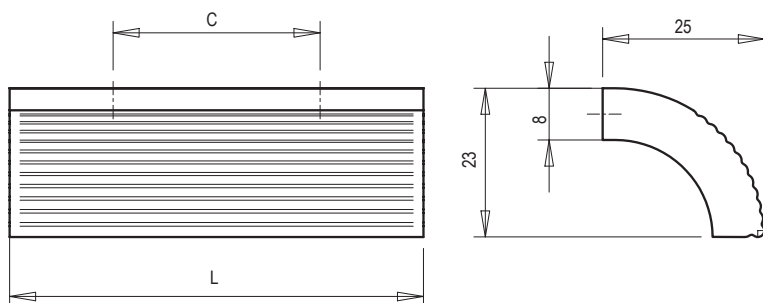
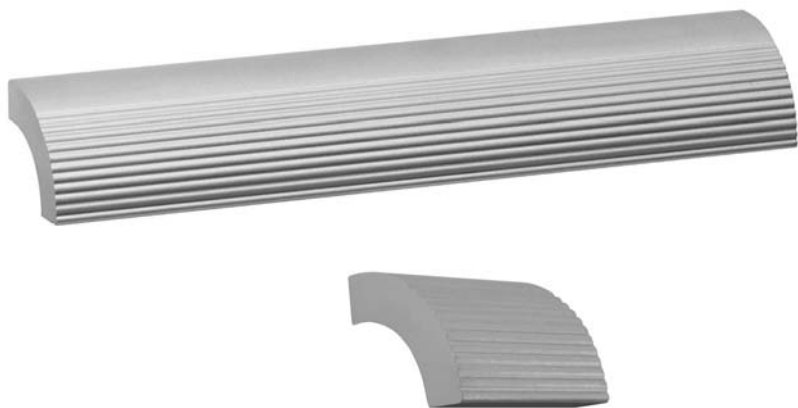

cod.	C	L	Descripción	
60201	016	032	ALUMINIO	25
60210	064	096	ALUMINIO	25
60215	096	128	ALUMINIO	25
60220	128	160	ALUMINIO	25
60225	160	192	ALUMINIO	10
60230	192	224	ALUMINIO	10
60235	224	256	ALUMINIO	10
60250	320	352	ALUMINIO	10
60280	512	544	ALUMINIO	10



al-3

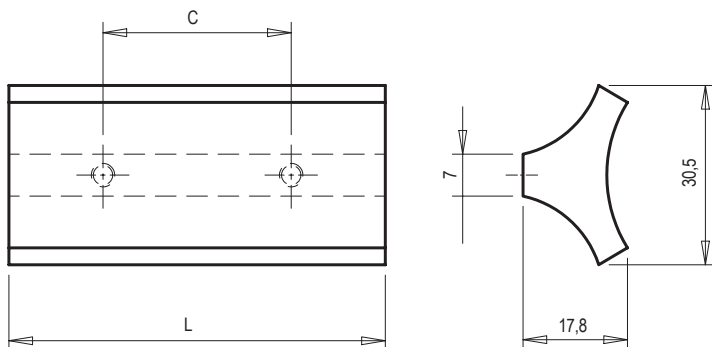
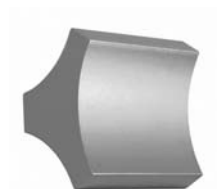

cod.	C	L	Descripción	
60301	016	032	ALUMINIO	25
60310	064	096	ALUMINIO	25
60315	096	128	ALUMINIO	25
60320	128	160	ALUMINIO	25
60325	160	192	ALUMINIO	10
60330	192	224	ALUMINIO	10
60335	224	256	ALUMINIO	10
60350	320	352	ALUMINIO	10
60380	512	544	ALUMINIO	10

al-4

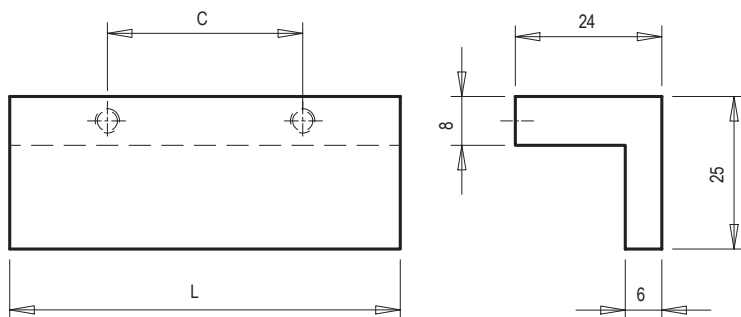

cod.	C	L	Descripción	
60401	016	032	ALUMINIO	25
60410	064	096	ALUMINIO	25
60415	096	128	ALUMINIO	25
60420	128	160	ALUMINIO	25
60425	160	192	ALUMINIO	10
60430	192	224	ALUMINIO	10
60435	224	256	ALUMINIO	10
60450	320	352	ALUMINIO	10
60480	512	544	ALUMINIO	10

pomos
knobs
boutons

AISI 303-304



i-125



cod.	ØD	ØB	L	
30025	25	18	20	25
30030	30	21	23	25
30035	35	24	27	25

INOX MATE AISI 304

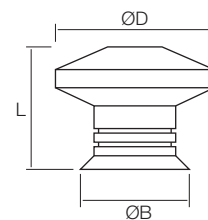

i-126



	cod.	ØD	L	
	30110	10	24	25
	30115	15	26	25
	30120	20	28	25
	30125	25	30	25
	30130	30	33	25
M-6	30140	40	48	10
*M-10	30150	50	44	2

INOX MATE AISI 304

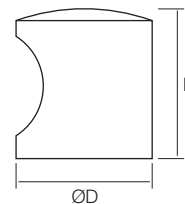

***Pomos para puertas ligeras.**

*Light door Knob.

*Bouton pour portes légères.

ed-126



cod.	ØD	L	
30215	15	22	25
30218	18	24	25
30221	20	26	25

INOX MATE AISI 304

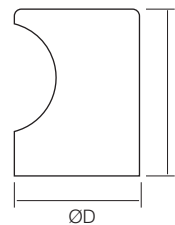

i-127



cod.	ØD	ØB	L	
30325	25	16	20	25
30330	30	19	24	25

INOX MATE AISI 304

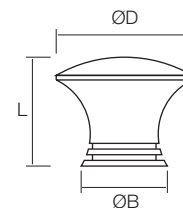

i-129



cod.	ØD	ØB	L	
31020	20	13	17	25
31025	25	17	21	25
31030	30	20	25	25
31035	35	24	27	25

INOX MATE AISI 304

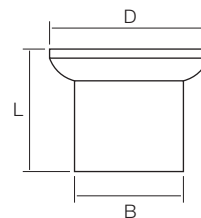

i-132



cod.	ØD	ØB	L	
31220	20	16	23	25
31225	25	20	28	25
31230	30	24	34	25

INOX MATE AISI 304

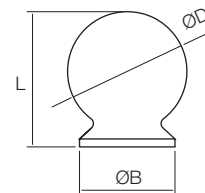

i-158



cod.	ØD	ØB	L	
31310	10	08	15	25
31315	15	08,5	20	25
31320	20	09	24,5	25
31325	25	10	30	25
31330	30	10	32,5	25
31335	35	12,5	40	25

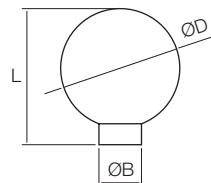

INOX MATE AISI 304

i-203



cod.	ØD	ØB	L	
32017	17	14	23	25

INOX MATE AISI 304

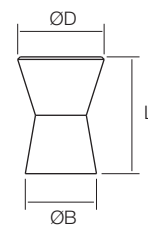

i-206



cod.	ØD	ØB	L	
------	----	----	---	---

32112	12	12	21,5	25
-------	----	----	------	----

INOX MATE AISI 304

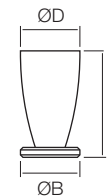

i-207

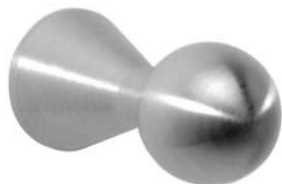

cod.	ØD	ØB	L	
------	----	----	---	---

32211	11	11	25	25
-------	----	----	----	----

INOX MATE AISI 304

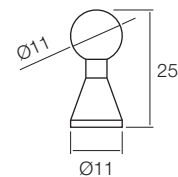

i-209



cod.	ØD	ØB	L	
32312	12	07	20	25
32316	16	08	26	25
32320	20	10	28	25
32325	24	14	29	25
32330	29	18	35	25

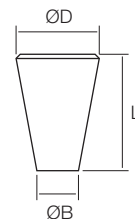

INOX MATE AISI 304

i-325



cod.	ØD	C	L	
32530	30	16	23,5	25
32535	35	16	25,5	25
32545	45	32	27,5	25

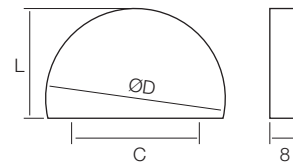

INOX MATE AISI 304

i-326



cod.	ØD	L	
32610	10	24	25
32615	15	29,5	25
32620	20	33	25
32625	25	35,5	25

INOX MATE AISI 304

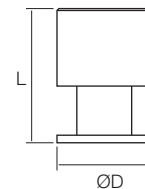

i-327



cod.	ØD	L	
32710	10	24	25
32715	15	25,5	25
32720	20	33,5	25
32725	25	35	25

INOX MATE AISI 304

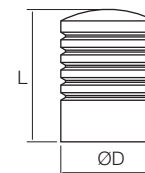

i-334



cod.	ØD	L	
33415	15	32,5	25
33420	20	37,5	25
33425	25	41,5	25

INOX MATE AISI 304

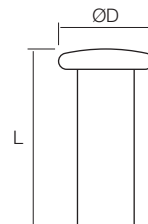

i-335



cod.	ØD	L	
33515	15	32,5	25
33520	20	37,5	25
33525	25	41,5	25

INOX MATE AISI 304

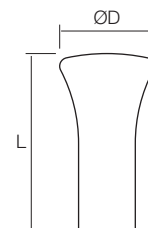

i-336



cod.	ØD	L	
33615	15	32,5	25
33620	20	37,5	25
33625	25	41,5	25

INOX MATE AISI 304

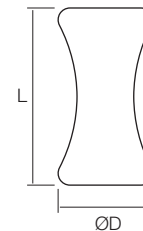

i-337



cod.	ØD	L	
33715	15	32,5	25
33720	20	37,5	25
33725	25	41,5	25

INOX MATE AISI 304

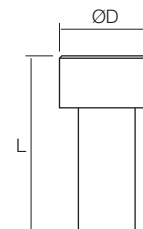

i-338



cod.	ØD	L	
33820	20	26	25
33825	25	32	25

INOX MATE AISI 304

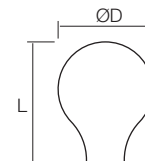

i-339



cod.	ØD	L	
33915	16	32,5	25
33920	20	37,5	25
33925	25	41,5	25

INOX MATE AISI 304

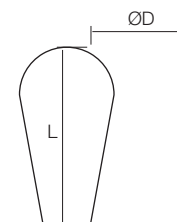

i-410



cod.	∅D	L	
34010	10	22	25
34015	15	25	25
34020	20	28	25
34025	25	30	25

INOX MATE AISI 304

KUBE

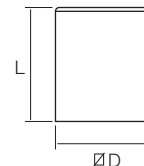

i-426



cod.	∅D	L	
34110	10	24	25
34115	15	30	25
34120	20	33	25
34125	25	36	25

INOX MATE AISI 304

KUBE

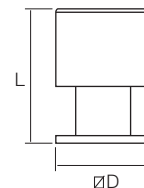

i-437



cod.	∅D	L	
34000	25	25	25

INOX MATE AISI 304

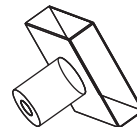
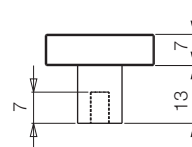
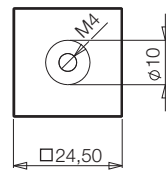

**tiradores de puerta, topes,
soportes pasamanos**

pull handles, door stoppers, handrail fittings
*bâton de maréchal, buttoirs de porte,
support de main courante*

AISI 303-304



i-1000

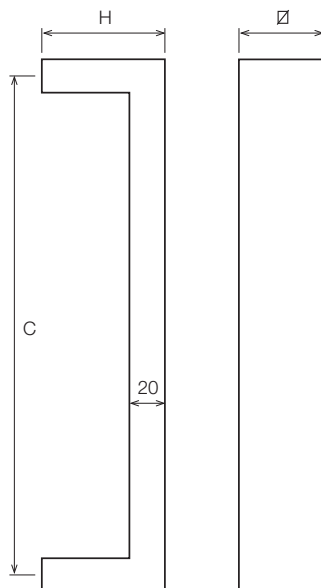

cod.	Ø	C	H	ext/set	
57420	40	200	65	ext	1
57520	40	200	65	int	1
44520	40	200	65	set	1
57430	40	300	65	ext	1
57530	40	300	65	int	1
44530	40	300	65	set	1
57450	40	500	65	ext	1
57550	40	500	65	int	1
44550	40	500	65	set	1

INOX MATE AISI 304

SET: EXT + INT + KIT 4

- A juego con i-100 pg. 5 y serie Big Bath en pg. 136 - 141.

- Matches with ref. i-100 and Big Bath on page 136 - 141.

- Combine avec ref. i-100 et Big Bath sur la page 136 - 141.

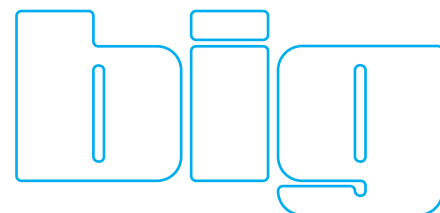

by **didheya**
accesorios esenciales

i-1260



cod.	Ø	L		
53200	50	48	gir	1
53201	50	44	fix	1

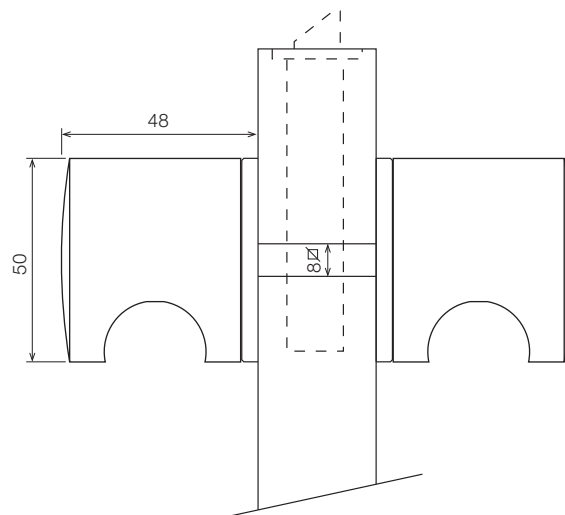

i-1310 Ø20-25-30



cod.	Ø	C	H	ext/set	
51015	20	150	55	ext	1
51115	20	150	55	int	1
42115	20	150	55	set	1
51020	20	200	55	ext	1
51120	20	200	55	int	1
42120	20	200	55	set	1
51025	20	250	55	ext	1
51125	20	250	55	int	1
42125	20	250	55	set	1
51030	20	300	55	ext	1
51130	20	300	55	int	1
42130	20	300	55	set	1
51220	25	200	70	ext	1
51320	25	200	70	int	1
42220	25	200	70	set	1
51225	25	250	70	ext	1
51325	25	250	70	int	1
42225	25	250	70	set	1
51230	25	300	70	ext	1
51330	25	300	70	int	1
42230	25	300	70	set	1
51425	30	250	90	ext	1
51525	30	250	90	int	1
42325	30	250	90	set	1
51430	30	300	90	ext	1
51530	30	300	90	int	1
42330	30	300	90	set	1
51435	30	350	90	ext	1
51535	30	350	90	int	1
42335	30	350	90	set	1
51445	30	450	90	ext	1
51545	30	450	90	int	1
42345	30	450	90	set	1
51460	30	600	90	ext	1
51560	30	600	90	int	1
42360	30	600	90	set	1
51465	30	650	90	ext	1
51565	30	650	90	int	1
42365	30	650	90	set	1

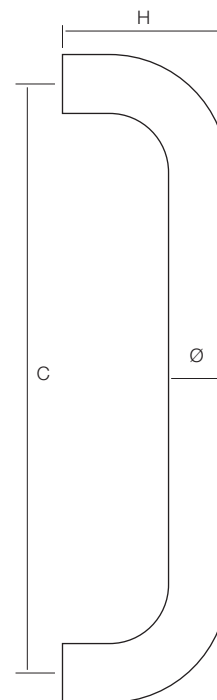

INOX MATE AISI 304

SET: EXT + INT + KIT 4

- A juego con i-131 pg. 10.
- Matches with ref. i-131 pg. 10.
- Combine avec ref. i-131 pg. 10.

i-1630 Ø30



cod.	Ø	C	H	ext/set	
52025	30	250	66	ext	1
52125	30	250	66	int	1
45125	30	250	66	set	1
52030	30	300	70	ext	1
52130	30	300	70	int	1
45130	30	300	70	set	1
52035	30	350	74	ext	1
52135	30	350	74	int	1
45135	30	350	74	set	1
52045	30	450	80	ext	1
52145	30	450	80	int	1
45145	30	450	80	set	1
52060	30	600	80	ext	1
52160	30	600	80	int	1
45160	30	600	80	set	1
52065	30	650	88	ext	1
52165	30	650	88	int	1
45165	30	650	88	set	1

INOX MATE AISI 304

SET: EXT + INT + KIT 4

- **A juego con tirador i-163 pg. 12.**

- Matches with ref. i-163 pg. 12.

- *Combine avec ref. i-163 pg. 12.*

- **No apto para cristal.**

- Not available for glass.

- *Pas disponible pour porte en verre.*

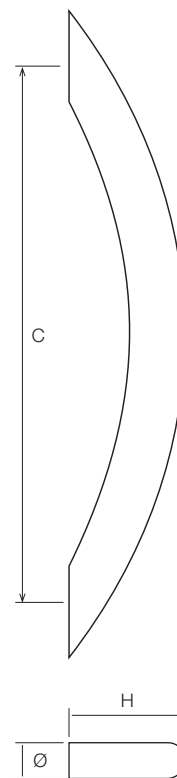

i-2000 Ø20



cod.	Ø	C	H	ext/set	
54020	20	200	300	ext	1
54120	20	200	300	int	1
43020	20	200	300	set	1
54025	20	250	400	ext	1
54125	20	250	400	int	1
43025	20	250	400	set	1
54030	20	300	450	ext	1
54130	20	300	450	int	1
43030	20	300	450	set	1
54050	20	500	700	ext	1
54150	20	500	700	int	1
43050	20	500	700	set	1
54080	20	800	1000	ext	1
54180	20	800	1000	int	1
43080	20	800	1000	set	1
54000	20	1000	1200	ext	1
54100	20	1000	1200	int	1
43000	20	1000	1200	set	1

INOX MATE AISI 304

SET: EXT + INT + KIT 4

- A juego con tirador i-200 pg. 13-14-15.

- Matches with ref. i-200 pg. 13-14-15.

- Combine avec ref. i-200 pg. 13-14-15.

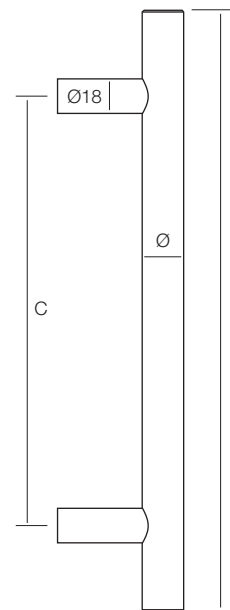

i-2000 Ø30



cod.	Ø	C	H	ext/set	
54225	30	250	550	ext	1
54325	30	250	550	int	1
43125	30	250	550	set	1
54230	30	300	600	ext	1
54330	30	300	600	int	1
43130	30	300	600	set	1
54235	30	350	650	ext	1
54335	30	350	650	int	1
43135	30	350	650	set	1
54245	30	450	750	ext	1
54345	30	450	750	int	1
43145	30	450	750	set	1
54260	30	600	900	ext	1
54360	30	600	900	int	1
43160	30	600	900	set	1
54265	30	650	950	ext	1
54365	30	650	950	int	1
43165	30	650	950	set	1

INOX MATE AISI 304

SET: EXT + INT + KIT 4

- A juego con tirador i-200 pg. 13-14-15.

- Matches with ref. i-200 pg. 13-14-15.

- Combine avec ref. i-200 pg. 13-14-15.

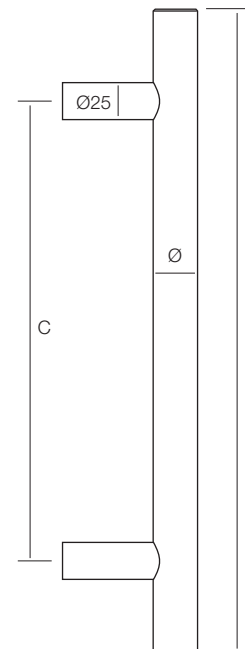

i-2630 Ø30



cod.	Ø	C	L	H	ext/set	
52220	30	200	500	90	ext	1
52320	30	200	500	90	int	1
45220	30	200	500	90	set	1
52225	30	250	550	90	ext	1
52325	30	250	550	90	int	1
45225	30	250	550	90	set	1
52250	30	500	800	90	ext	1
52350	30	500	800	90	int	1
45250	30	500	800	90	set	1

INOX MATE AISI 304

SET: EXT + INT + KIT 4

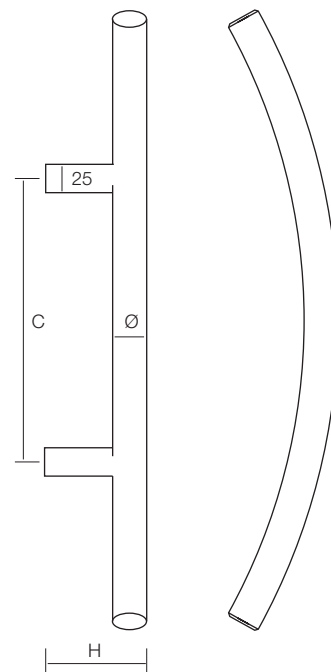

i-2700 Ø30



cod. Ø C L H ext/set 

54425	30	250	550	78	ext	1
54525	30	250	550	78	int	1
43325	30	250	550	78	set	1
54430	30	300	600	78	ext	1
54530	30	300	600	78	int	1
43330	30	300	600	78	set	1
54435	30	350	650	78	ext	1
54535	30	350	650	78	int	1
43335	30	350	650	78	set	1
54460	30	600	900	78	ext	1
54560	30	600	900	78	int	1
43360	30	600	900	78	set	1
54465	30	650	950	78	ext	1
54565	30	650	950	78	int	1
43365	30	650	950	78	set	1

INOX MATE AISI 304

SET: EXT + INT + KIT 4

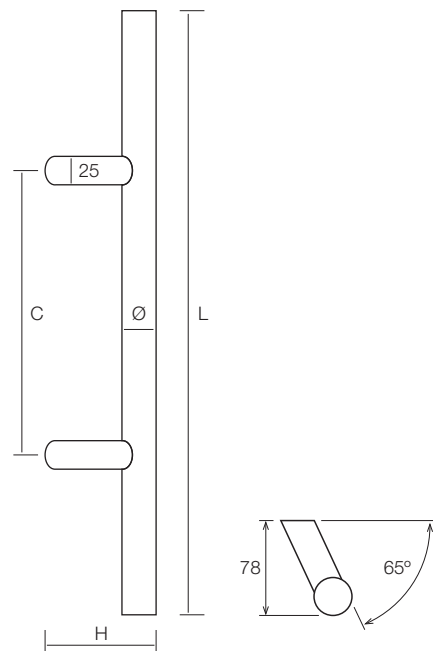

i-3310 Ø15-20-30



cod.	Ø	C	H	ext/set	
50015	15	150	55	ext	1
50115	15	150	55	int	1
42415	15	150	55	set	1
50020	15	200	55	ext	1
50120	15	200	55	int	1
42420	15	200	55	set	1
50030	15	300	55	ext	1
50130	15	300	55	int	1
42430	15	300	55	set	1
50220	20	200	65	ext	1
50320	20	200	65	int	1
42520	20	200	65	set	1
50225	20	250	65	ext	1
50325	20	250	65	int	1
42525	20	250	65	set	1
50230	20	300	65	ext	1
50330	20	300	65	int	1
42530	20	300	65	set	1
50425	30	250	90	ext	1
50525	30	250	90	int	1
42625	30	250	90	set	1
50430	30	300	90	ext	1
50530	30	300	90	int	1
42630	30	300	90	set	1
50435	30	350	90	ext	1
50535	30	350	90	int	1
42635	30	350	90	set	1
50460	30	600	90	ext	1
50560	30	600	90	int	1
42660	30	600	90	set	1

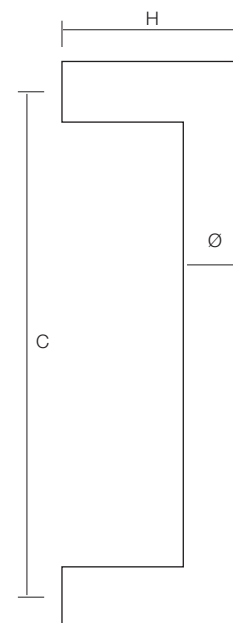

INOX MATE AISI 304

SET: EXT + INT + KIT 4

- **A juego con tirador i-331 pg. 20.**

- Matches with ref. i-331 pg. 20.

- *Combine avec ref. i-331 pg. 20.*

i-3630 Ø30



cod.	Ø	C	H	ext/set	
52430	30	300	90	ext	1
52530	30	300	90	int	1
45430	30	300	90	set	1
52450	30	500	90	ext	1
52550	30	500	90	int	1
45450	30	500	90	set	1

INOX MATE AISI 304

SET: EXT + INT + KIT 4

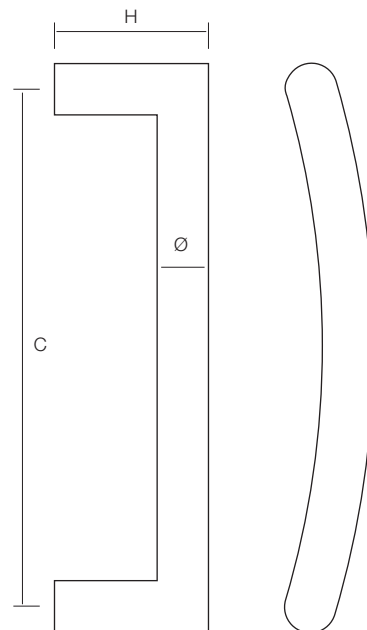

i-3330 Ø30



cod.	Ø	C	H	ext/set	
50830	30	300	90	ext	1
50930	30	300	90	int	1
42830	30	300	90	set	1
50850	30	500	90	ext	1
50950	30	500	90	int	1
42850	30	500	90	set	1

INOX MATE AISI 304

SET: EXT + INT + KIT 4

- A juego con tirador i-333 pg. 22.
- Matches with ref. i-333 pg. 22.
- Combine avec ref. i-333pg. 22.

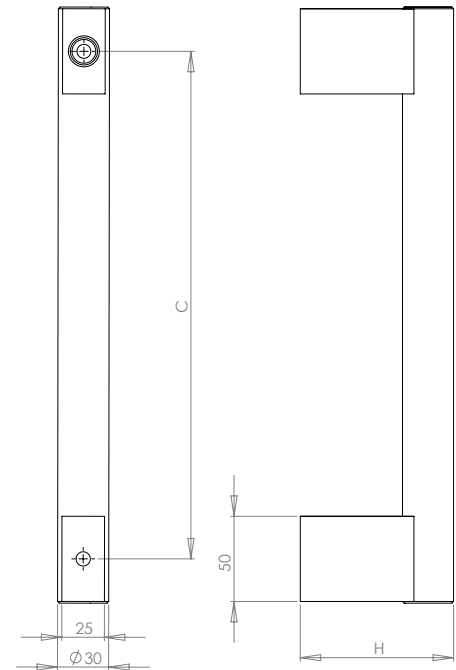

i-4000 Ø20-30



cod.	Ø	Ø	C	L	H	ext/set	
57020	20	18	200	300	65	ext	1
57120	20	18	200	300	65	int	1
44320	20	18	200	300	65	set	1
57025	20	18	250	400	65	ext	1
57125	20	18	250	400	65	int	1
44325	20	18	250	400	65	set	1
57030	20	18	300	450	65	ext	1
57130	20	18	300	450	65	int	1
44330	20	18	300	450	65	set	1
57230	30	25	300	600	90	ext	1
57330	30	25	300	600	90	int	1
44430	30	25	300	600	90	set	1
57235	30	25	350	650	90	ext	1
57335	30	25	350	650	90	int	1
44435	30	25	350	650	90	set	1
57250	30	25	500	800	90	ext	1
57350	30	25	500	800	90	int	1
44450	30	25	500	800	90	set	1
57260	30	25	600	900	90	ext	1
57360	30	25	600	900	90	int	1
44460	30	25	600	900	90	set	1

INOX MATE AISI 304

SET: EXT + INT + KIT 4

- A juego con tirador i-400 pg. 26 y pomo i-426 pg.55.
- Matches with handle i-400 pg. 26 and knob i-426 pg. 55.
- Combine avec poignée i-400 pg. 26 et bouton i-426 pg.55.

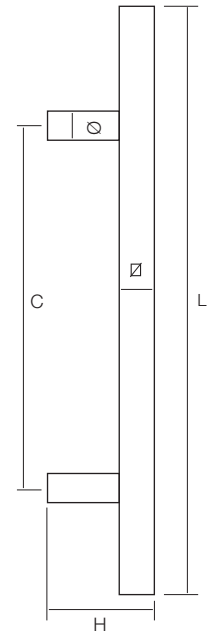

KUBE

i-4400 Ø15-20-30



cod.	Ø	C	H	ext/set	
58015	15	150	55	ext	1
58115	15	150	55	int	1
44015	15	150	55	set	1
58020	15	200	55	ext	1
58120	15	200	55	int	1
44020	15	200	55	set	1
58030	15	300	55	ext	1
58130	15	300	55	int	1
44030	15	300	55	set	1
58220	20	200	65	ext	1
58320	20	200	65	int	1
44120	20	200	65	set	1
58225	20	250	65	ext	1
58325	20	250	65	int	1
44125	20	250	65	set	1
58230	20	300	65	ext	1
58330	20	300	65	int	1
44130	20	300	65	set	1
58425	30	250	90	ext	1
58525	30	250	90	int	1
44225	30	250	90	set	1
58430	30	300	90	ext	1
58530	30	300	90	int	1
44230	30	300	90	set	1
58435	30	350	90	ext	1
58535	30	350	90	int	1
44235	30	350	90	set	1
58460	30	600	90	ext	1
58560	30	600	90	int	1
44260	30	600	90	set	1

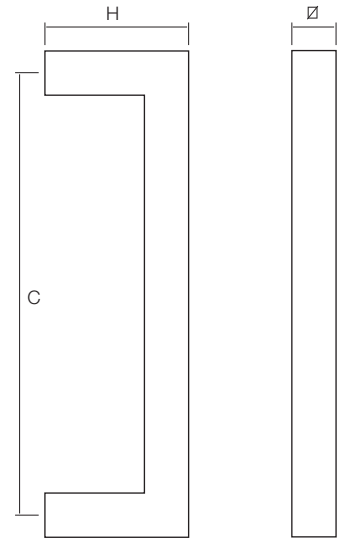

KUBE

INOX MATE AISI 304

SET: EXT + INT + KIT 4

- **A juego con tirador i-440 pg. 27 y pomo i-410 pg.55.**

- Matches with handle i-440 pg. 27 and knob i-410 pg. 55.

- Combine avec poignée i-440 pg. 27 et bouton i-410 pg.55.

Kits de fijación para manillones/Fixing kits/Kits de fixation

kit asidero simple a puerta de madera / cristal
bolt-through for wood / glass doors
kit fixation tirant simple pour porte en bois / verre



Cod	Descripción	Ø Taladro cristal	Modelos
94502	KIT - 2 / ø 15 mm M5	10 mm	I-3310 Ø 15
94507	KIT - 2 / □ 15 mm M5	10 mm	I-4400 Ø 15
94002	KIT - 2 / ø 20 mm M6	10 mm	I-1310 Ø20 / I-2000 Ø20 / I-3310 Ø20 / I-4000 Ø20
94302	KIT - 2 / □ 20 mm M6	10 mm	I-1000 / I-4400 Ø20
94102	KIT - 2 / ø 25 mm M8	12 mm	I-1310 Ø 25
94202	KIT - 2 / ø 30 mm M8	12 mm	I-1310 / I-1630 / I-2000 / I-2630 / I-2700 / I-3310 / I-3630 / I-4000 / I-3330 / I-3290
94402	KIT - 2 / □ 30 mm M8	12 mm	I-4400 Ø30 / I-4290

kit asidero doble a puerta de madera / cristal
back-to-back for wood / glass doors
kit fixation tirant double pour porte en bois / verre



Cod	Descripción	Ø Taladro cristal	Modelos
94504	KIT - 4 / ø 15 mm M5	10 mm	I-3310 Ø 15
94509	KIT - 4 / □ 15 mm M5	10 mm	I-4400 Ø 15
94004	KIT - 4 / ø 20 mm M6	10 mm	I-1310 Ø20 / I-2000 Ø20 / I-3310 Ø20 / I-4000 Ø20
94304	KIT - 4 / □ 20 mm M6	10 mm	I-1000 / I-4400 Ø20
94104	KIT - 4 / ø 25 mm M8	12 mm	I-1310 Ø 25
94204	KIT - 4 / ø 30 mm M8	12 mm	I-1310 / I-1630 / I-2000 / I-2630 / I-2700 / I-3310 / I-3630 / I-4000 / I-3330 / I-3290
94404	KIT - 4 / □ 30 mm M8	12 mm	I-4400 Ø30 / I-4290

kit asidero fijación pared / tornillo no pasante
wall fixing / front mounting
kit fixation mur / vis non transversant



Cod	Descripción	Modelos
94505	KIT - 5 / ø 15 mm	I-3310 Ø 15 / I-4400 Ø 15
94005	KIT - 5 / ø 20 mm	I-1310 Ø 20 / I-2000 Ø 20 / I-3310 Ø 20 / I-1000 / I-4400 Ø 20 / I-4000 Ø 20
94105	KIT - 5 / ø 25 mm	I-1310 Ø 25
94205	KIT - 5 / ø 30 mm	I-1310 / I-1630 / I-2000 / I-2630 / I-2700 / I-3310 / I-3630 / I-4000 / I-4400 / I-3330

i-3290

Link It

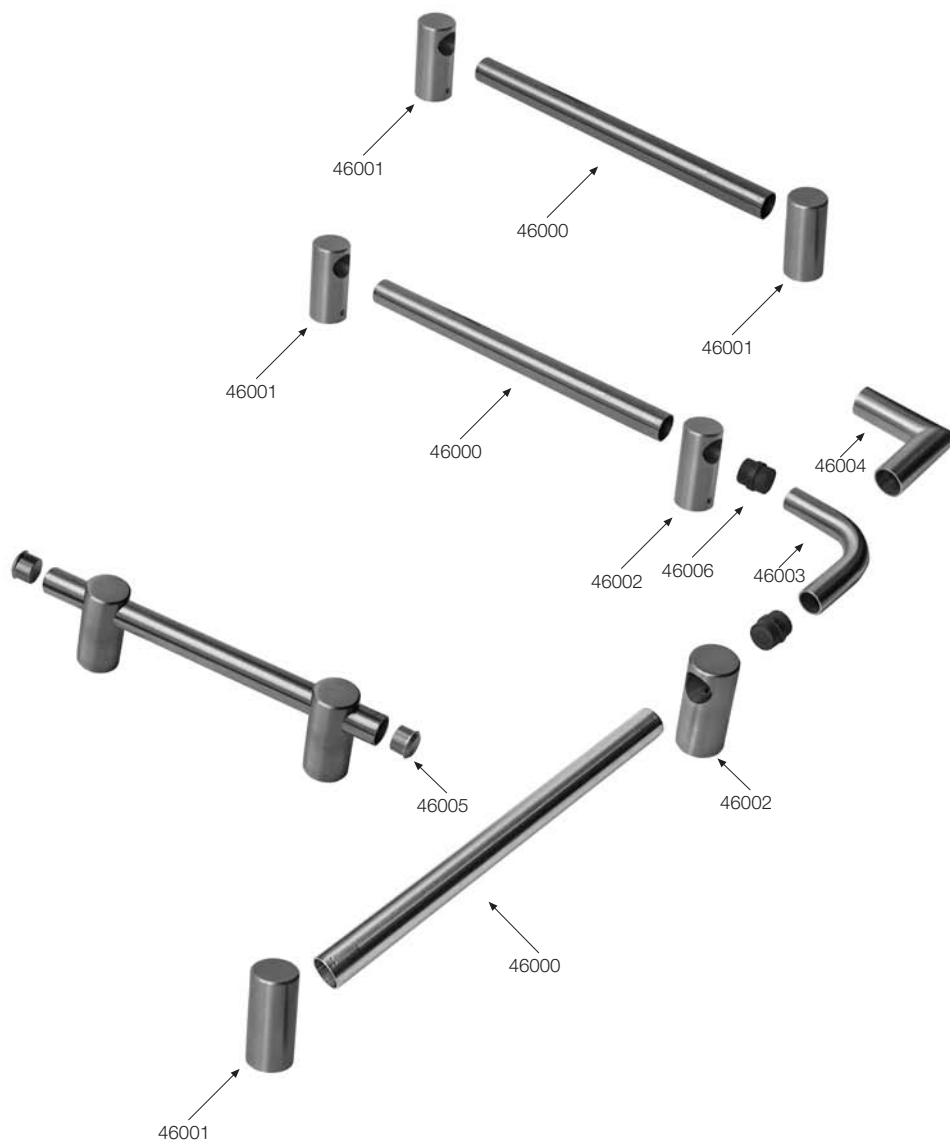

Construya su propio manillón, toallero, soporte de pasamanos o barra para cortinas adaptándolo a la medida deseada.

Make your own pull handle, towel rack, handrail or curtain rail, at any required size.

Construire votre bâton de maréchal, support serviette, main courante ou tringle à rideaux, à la mesure désirée.

cod.	descripción	
46000	I-3290 Tube 2Mts. 20mm. SS. Tubo Inox Mate	5
46007	I-3290 Tube 3Mts. 20mm. SS. Tubo Inox Mate	5
46001	I-3290 Bracket 30mm. SS. Terminal Inox Mate	14
46002	I-3290 Center bracket 30mm. SS. Soporte central	14
46003	I-3290 90° Curve Angle SS. Ángulo curvo Inox Mate	4
46004	I-3290 90° Straight Angle SS. Ángulo recto	4
46005	I-3290 20mm. End cap SS. Tapón Inox Mate	20
46006	I-3290 20mm. nylon connector.Unión nylon 20 mm.	20

i-4290

Link It

Construya su propio manillón, toallero, soporte de pasamanos o barra para cortinas adaptándolo a la medida deseada.

Make your own pull handle, towel rack, handrail or curtain rail, at any required size.

Construire votre bâton de maréchal, support serviette, main courante ou tringle à rideaux, à la mesure désirée.

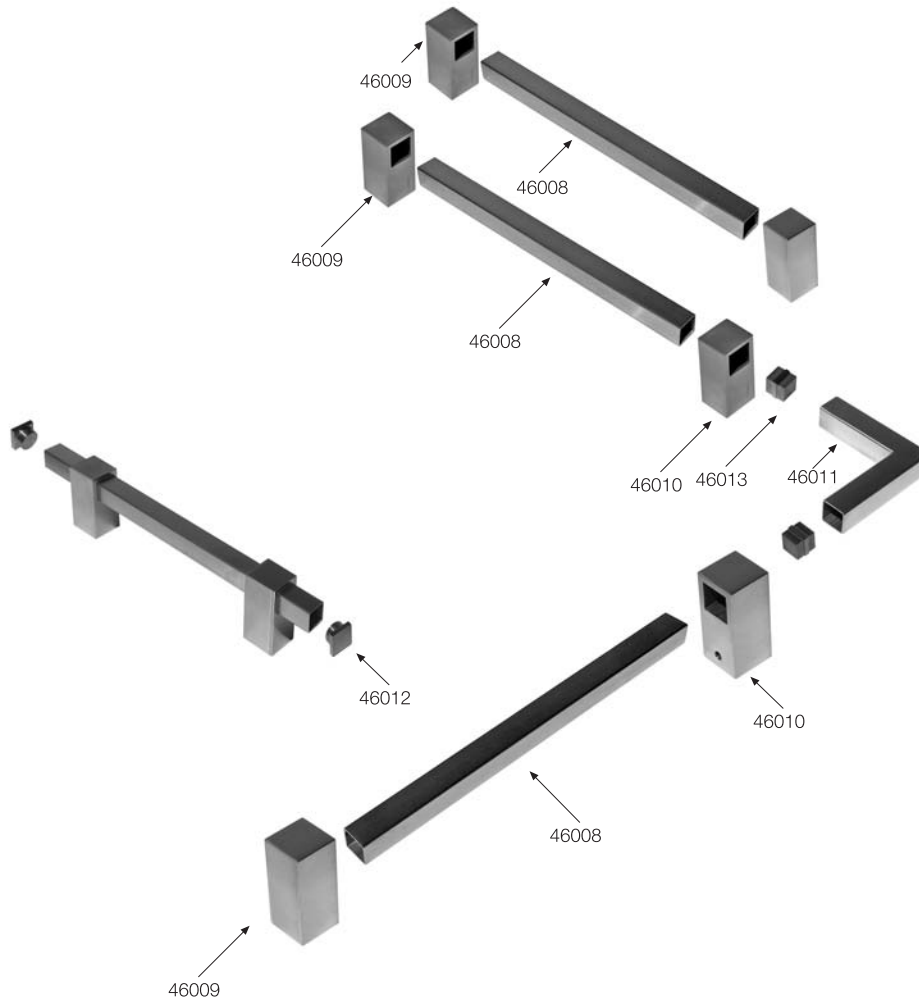

cod.	descripción	
46008	I-4290 Tube 2Mts. 20mm. SS. Cuadrado Inox Mate	5
46014	I-4290 Tube 3Mts. 20mm. SS. Cuadrado Inox Mate	5
46009	I-4290 Bracket 30mm. SS. Terminal Inox Mate	14
46010	I-4290 Center Bracket 30mm. SS. Soporte central	14
46011	I-4290 90° Straight Angle SS. Ángulo recto	4
46012	I-4290 20mm. End cap SS. Tapón Inox Mate	20
46013	I-4290 20mm. nylon connector. Unión nylon 20 mm.	20

z-4560



cod.	C	Descripción	
88710	200	26 Cromo Brillo	10
88711	200	02 Cromo Look	10
88712	200	15 Niquel Satinado	10
88713	200	04 Blanco Soft	10
88714	200	05 Negro Soft	10
88715	200	42 Cromo Mate	10
88716	200	A6 Laton Antiguo	10
88717	200	22 Old Silver	10

Tirador para puertas ligeras y correderas.

Pull handle for sliding and light doors.

Poignée pour portes légères et coulissantes.

Incluye sistema de fijación universal.

Universal fixing system is included.

Fixation universel est incluse.

- **A juego con tirador Tri z-456 pg. 35.**
- **Matches with handle Tri z-456 pg. 35.**
- **Combine avec poignée Tri z-456 pg. 35.**

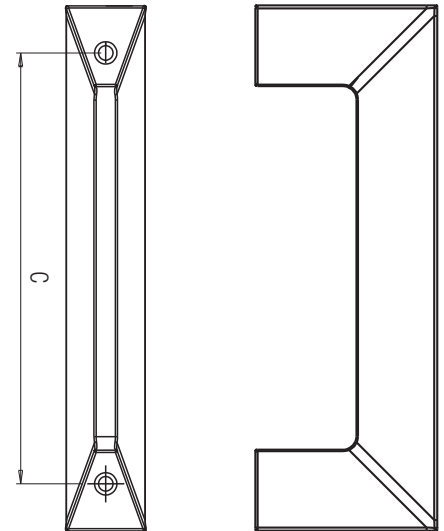

tiradores de puertas correderas
sliding door pull handles
poignées de portes coulissantes

AISI 303-304



i-3250



cod.	A	B	
53010	10	14	1
53012	12	16	1
53035	35	39	1
53040	40	44	1
53045	45	49	1
53050	50	54	1
53060	60	64	1

INOX MATE AISI 304

(A) Cualquier espesor de puerta sobre pedido.

Any door thickness available on request.

Toute epaisseur de porte sont disponibles sur demande.

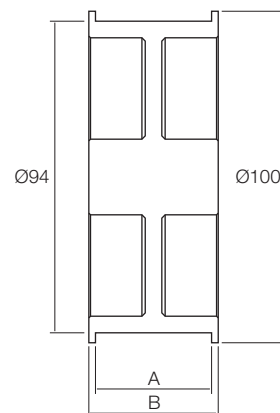
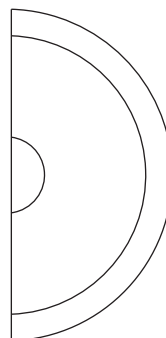

i-3250 WHITE



cod.	A	B		descripcion
53556	35	44	1	WHITE
53558	40	49	1	WHITE

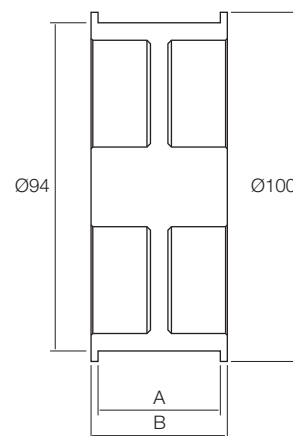
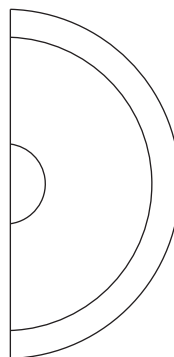

i-3250 BLACK



cod.	A	B		descripcion
53557	35	44	1	BLACK
53559	40	49	1	BLACK

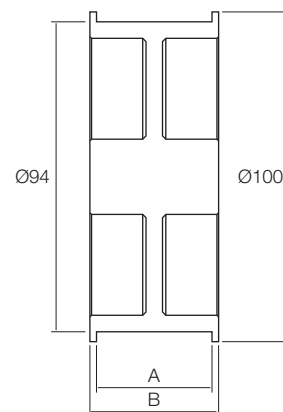
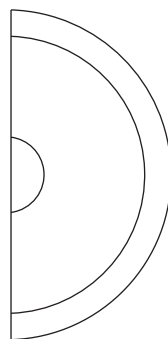

L-3250 ANTIQUE BRASS A6



cod.	A		descripcion
53661	35	1	ANTIQUÉ BRASS A6
53663	40	1	ANTIQUÉ BRASS A6

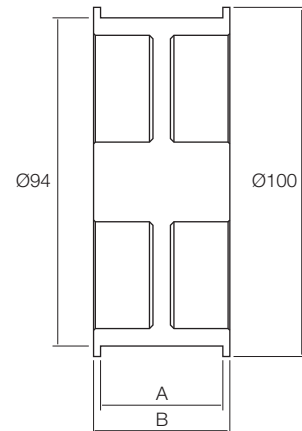
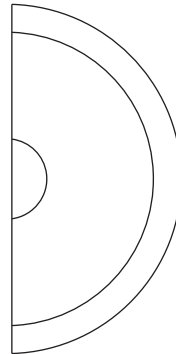

i-250



cod	A		descripcion.
31560	60	10	INOX MATE

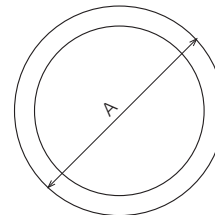
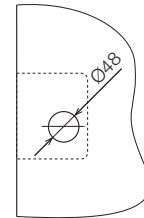

i-3250/1



cod		descripcion.
53100	1	INOX MATE

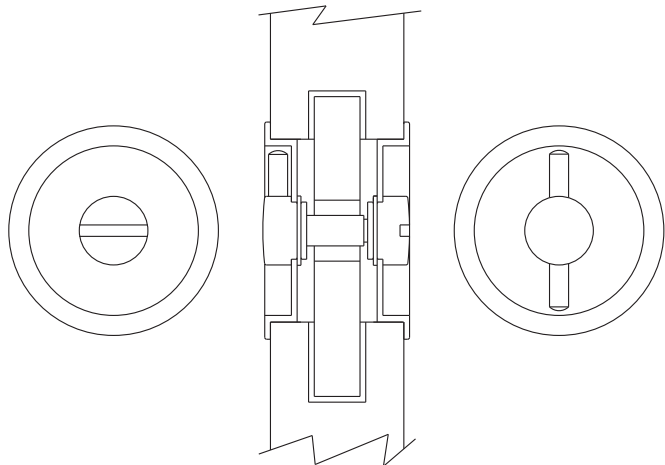
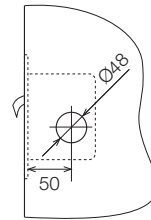



i-4250



cod.	A		descripcion.
53310	10	1	INOX MATE
53335	35	1	INOX MATE
53340	40	1	INOX MATE
53345	45	1	INOX MATE
53350	50	1	INOX MATE

(B) Cualquier espesor de puerta sobre pedido.

Any door thickness available on request.

Toute epaisseur de porte sont disponibles sur demande.

KUBE

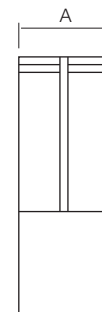
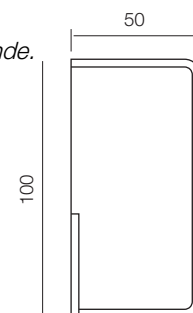

i-4250 WHITE



cod.	A		descripcion.
53606	35	1	WHITE
53608	40	1	WHITE

KUBE

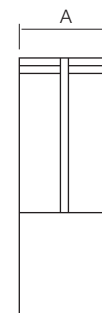
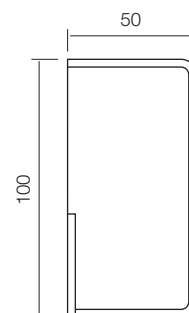

i-4250 BLACK



cod.	A		descripcion.
53607	35	1	BLACK
53609	40	1	BLACK

KUBE

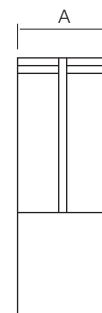
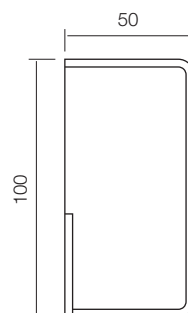

i-4251



cod.	X	Y	Z	
53701	35	120	55	1
53702	38	120	55	1
53703	40	120	55	1
53704	43	120	55	1
53705	50	120	55	1

INOX MATE AISI 304

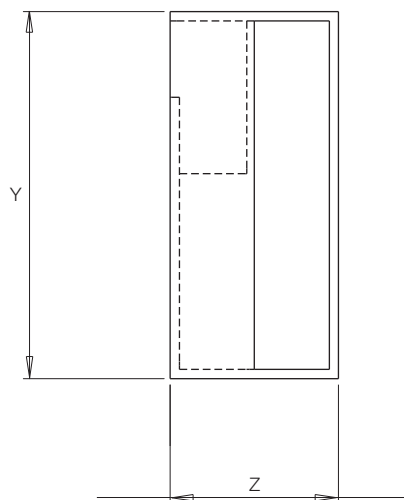
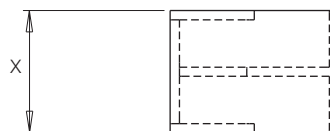

i- 4252



cod.	A		descripcion
------	---	---	-------------

53710	10	1	INOX MATE
-------	----	---	-----------

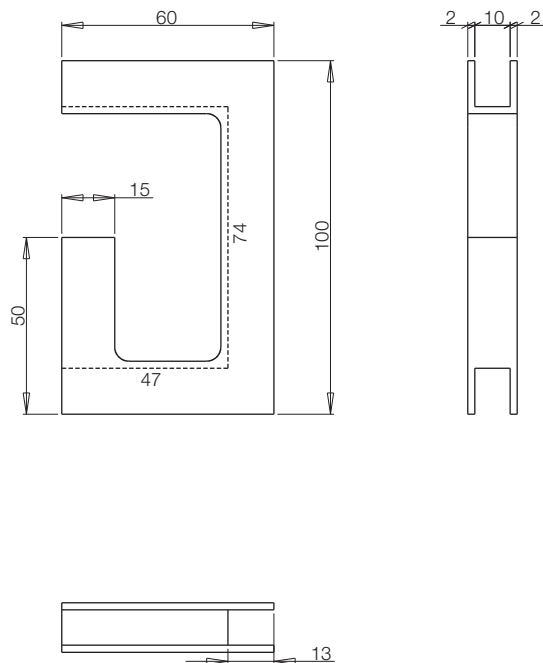

i- 4252 C



cod. A  descripcion

53711 10 1 INOX MATE

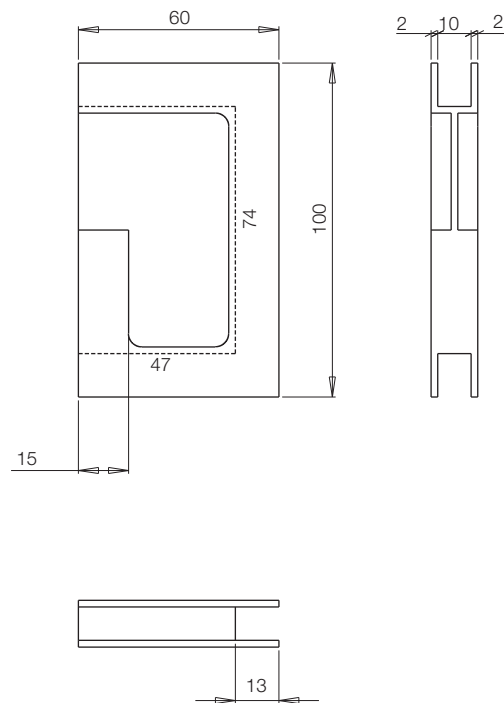

i- 4253



cod.	x	y	z	
53712	35	60	100	1
53713	38	60	100	1
53714	40	60	100	1
53715	43	60	100	1

INOX MATE

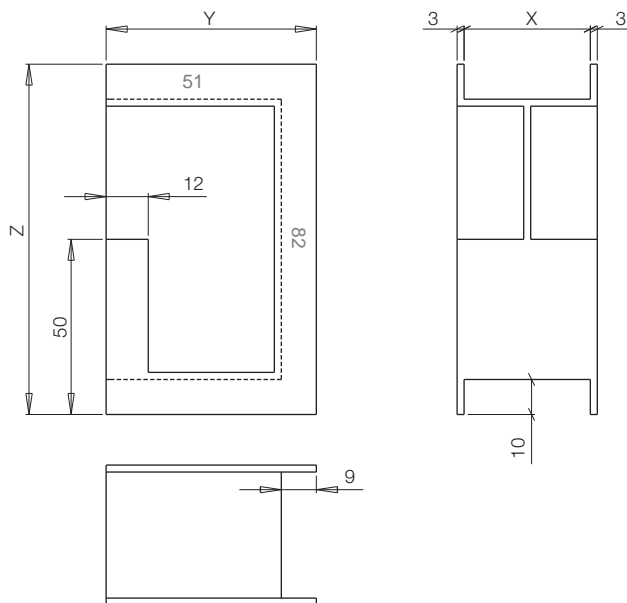

i- 4254



cod.	X	A	Z	Y	
53721	100	35	50	40	1
53722	100	38	50	40	1
53723	100	40	50	40	1
53726	200	35	85	110	1
53727	200	38	85	110	1
53728	200	40	85	110	1
53731	300	35	85	210	1
53732	300	38	85	210	1
53733	300	40	85	210	1
53736	500	35	85	410	1
53737	500	38	85	410	1
53738	500	40	85	410	1

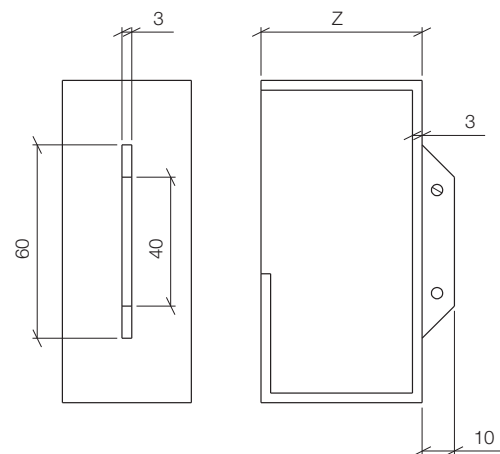

INOX MATE

(A) Cualquier espesor de puerta sobre pedido.

Any door thickness available on request.

Toute epaisseur de porte sont disponibles sur demande.

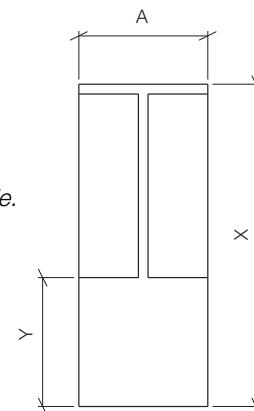

i-450



cod. 

53300 1

INOX MATE

KUBE

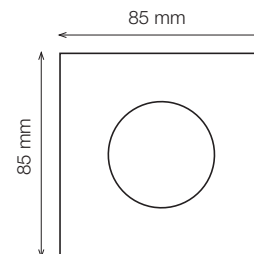
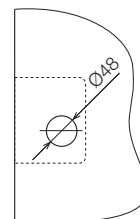

i-4250/1

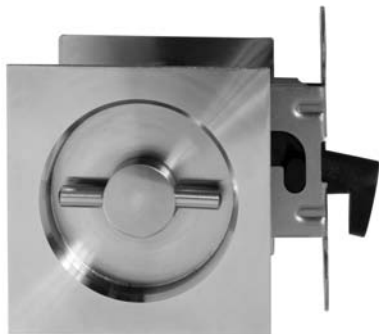

cod.



53300 1

INOX MATE

KUBE

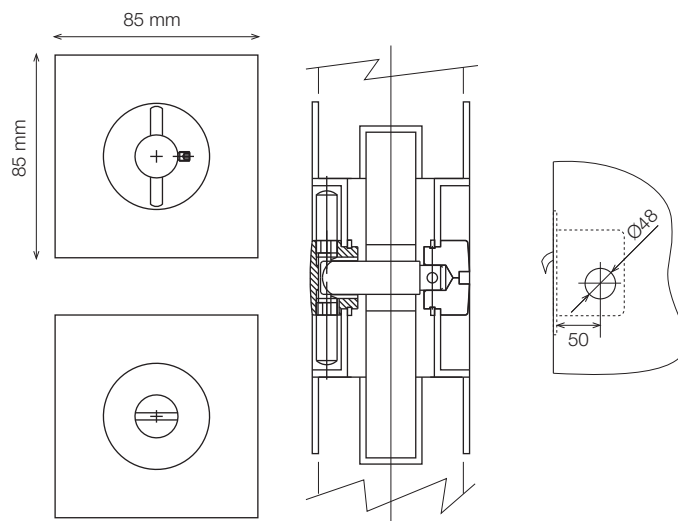



i- 5250



cod.	A		descripcion
53410	10	1	INOX MATE
53435	35	1	INOX MATE
53440	40	1	INOX MATE
53445	45	1	INOX MATE
53450	50	1	INOX MATE

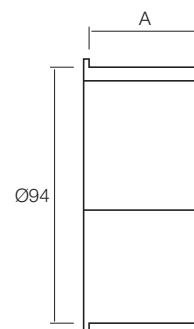
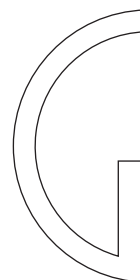



sly



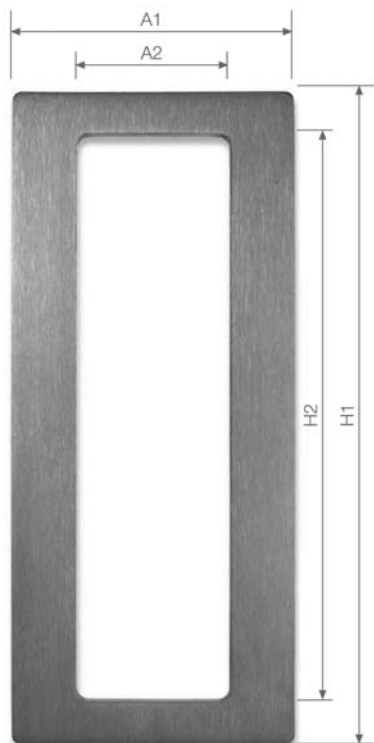

i-4020





cod.	H1	H2	A1	A2	e		descripcion
53515	085	065	50	20	6	1set	INOX MATE
53516	150	130	65	35	6	1set	INOX MATE
53517	300	280	80	50	6	1set	INOX MATE

Set: 2 manillones + dedal / 2 handles + thimble

i-4030

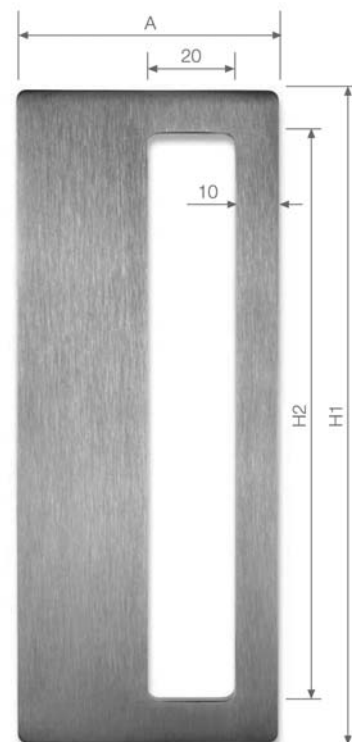
sly



cod.	H1	H2	A1	e		descripcion
53518	150	130	60	6	1set	INOX MATE
53519	300	280	75	6	1set	INOX MATE
53520	500	480	90	6	1set	INOX MATE

i-3010

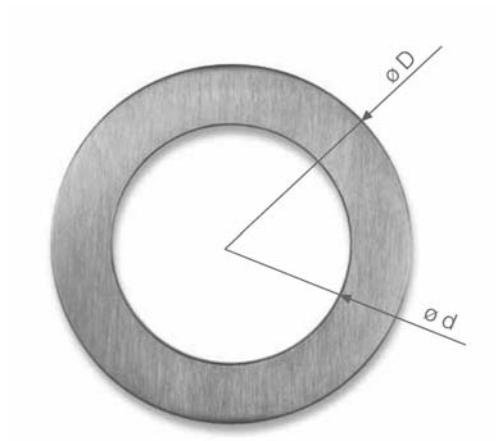

cod.	D	d	e		descripcion
53500	040	24	6	1set	INOX MATE
53501	070	46	6	1set	INOX MATE
53502	100	68	6	1set	INOX MATE

i-4010

sly

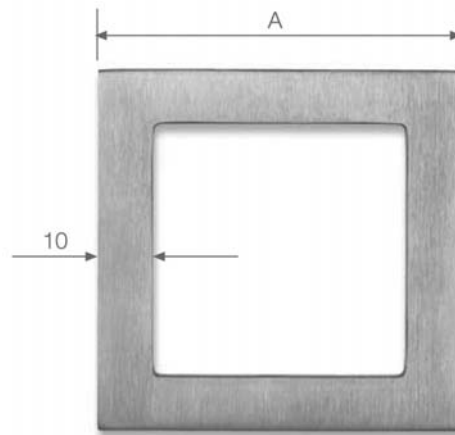

cod.	A	e		descripcion
53512	50	6	1set	INOX MATE
53513	65	6	1set	INOX MATE
53514	85	6	1set	INOX MATE



i-4040

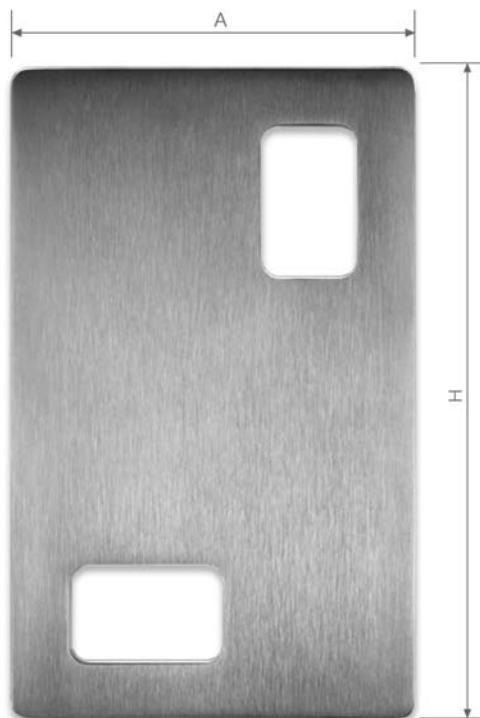

cod.	H	A	e		descripcion
53521	085	050	6	1set	INOX MATE
53522	150	092,71	6	1set	INOX MATE
53523	300	185,41	6	1set	INOX MATE

i-4050

sly

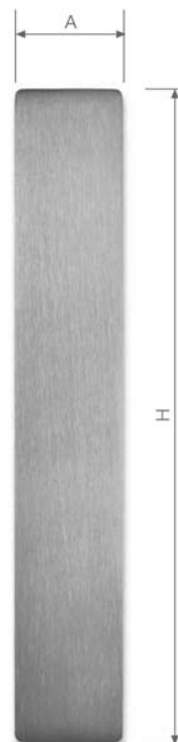



cod.	H	A	e		descripcion
53524	085	20	6	1set	INOX MATE
53525	150	25	6	1set	INOX MATE
53526	300	30	6	1set	INOX MATE

Set: 2 manillones + dedal / 2 handles + thimble

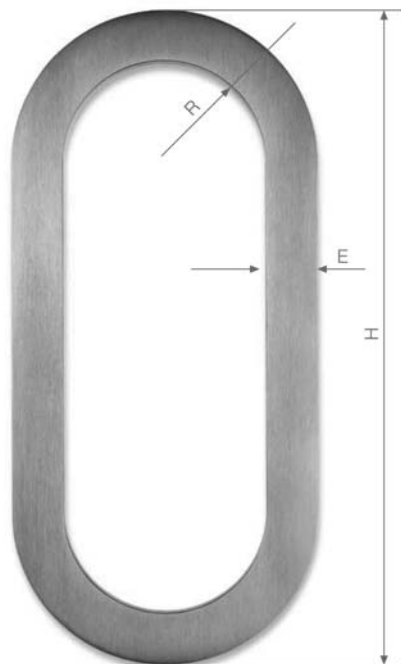

i-3020



cod.	R	H	E	e		descripcion
53503	20	085	8	6	1set	INOX MATE
53504	35	150	12	6	1set	INOX MATE
53505	50	300	16	6	1set	INOX MATE

i-4060

sly

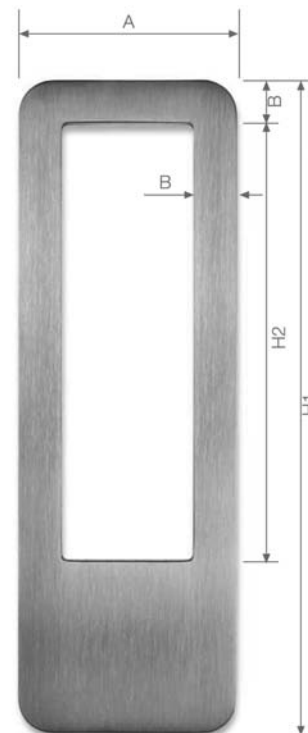

cod.	H1	H2	A	B	e		descripcion
53527	085	059	35	6	6	1set	INOX MATE
53528	150	100	50	10	6	1set	INOX MATE
53529	300	225	90	15	6	1set	INOX MATE



i-3030

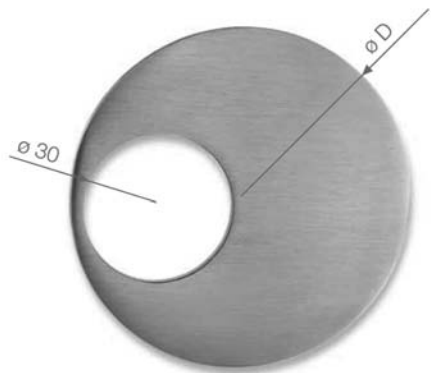

cod.	D	e		descripcion
53506	040	6	1set	INOX MATE
53507	070	6	1set	INOX MATE
53508	105	6	1set	INOX MATE

i-3040

sly

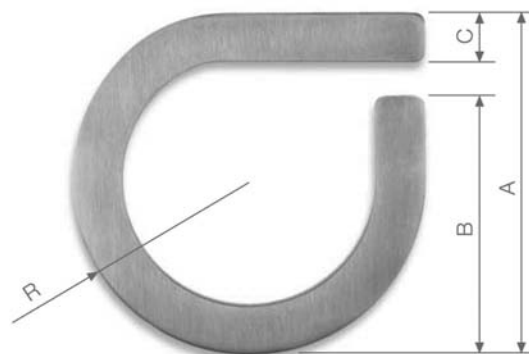

cod.	A	B	C	R	e		descripcion
53509	40	30	8	20	6	1set	INOX MATE
53510	70	60	10	35	6	1set	INOX MATE
53511	100	87,50	12	50	6	1set	INOX MATE

Set: 2 manillones + dedal / 2 handles + thimble

BISAGRA INVISIBLE INOX



cod.	A	B	C	D	kg. por carga de bisagra		descripcion
OCU10	12,70	044,45	19,05	9	10	10	INOX MATE+CROMO SATINADO
OCU20	15,80	069,85	34,13	12	20	10	INOX MATE+CROMO SATINADO
OCU30	19,05	095,25	52,39	13	30	5	INOX MATE+CROMO SATINADO
OCU40	25,40	117,48	65,88	18	40	2	INOX MATE+CROMO SATINADO
OCU50	28,58	117,48	61,91	21	50	2	INOX MATE+CROMO SATINADO

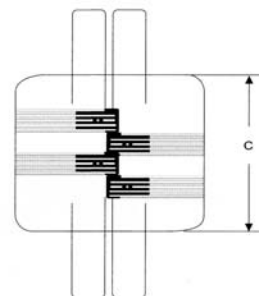
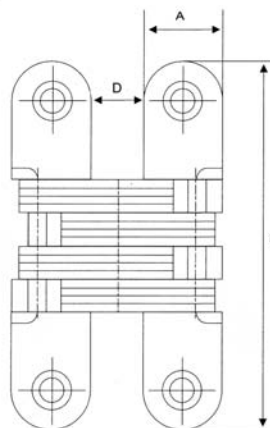

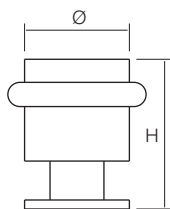

tope 2

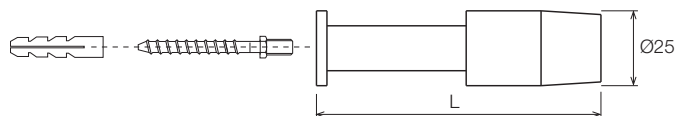

cod.	\varnothing	H		descripcion
91020	20	35	25	INOX MATE
91035	35	50	10	INOX MATE

tope 3



cod.	\varnothing	L		descripcion
91100	25	65	10	INOX MATE
91101	25	95	10	INOX MATE
91102	25	125	10	INOX MATE

tope 4

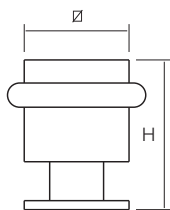

cod.	\varnothing	H		descripcion
91220	20	35	25	INOX MATE
91235	35	50	10	INOX MATE

KUBE

tope R

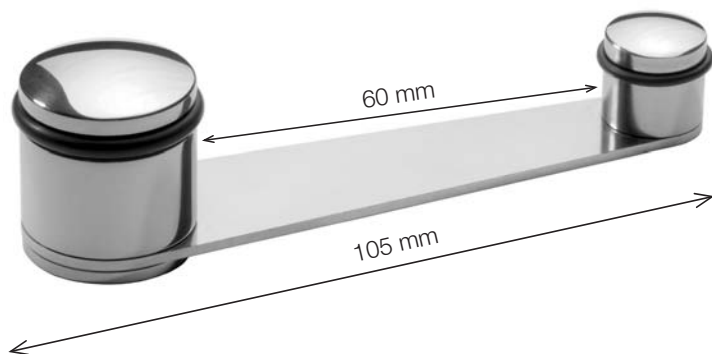

cod.		descripcion
91040	10	INOX MATE

soporte pasamanos curvo

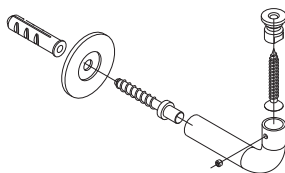
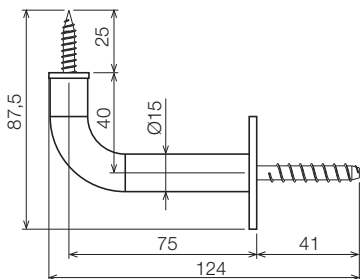

cod.	\varnothing	L	
93001	15	75	10

INOX MATE

soporte pasamanos recto

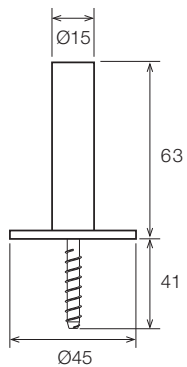

cod.	Ø	L	
93002	15	63	10

INOX MATE

soporte pasamanos kube



cod.



93003 10

INOX MATE

KUBE

portaestantes
shelf support
support tablette



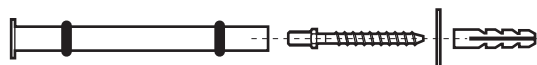
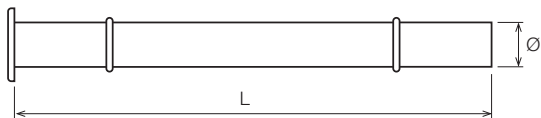

pe Ø12-14-20

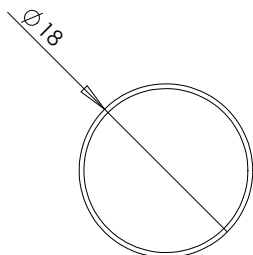
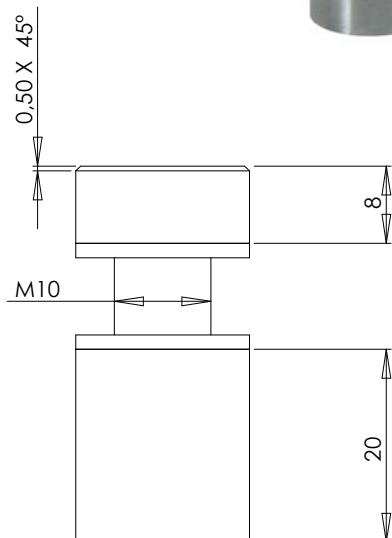

cod.	Ø	L		descripcion
90012	12	120	10	INOX MATE
90015	12	150	10	INOX MATE
90020	12	200	10	INOX MATE
90115	14	150	10	INOX MATE
90120	14	200	10	INOX MATE
90124	14	240	10	INOX MATE
90130	14	300	10	INOX MATE
90220	20	200	10	INOX MATE
90225	20	250	10	INOX MATE
90230	20	300	10	INOX MATE

separador inox d. 18 mm



cod.	Ø	L	
93303	18	28	25

accesorios baño
bathroom accessories
accessoires de bain

AISI 303-304



ku-01

serie
kursaal

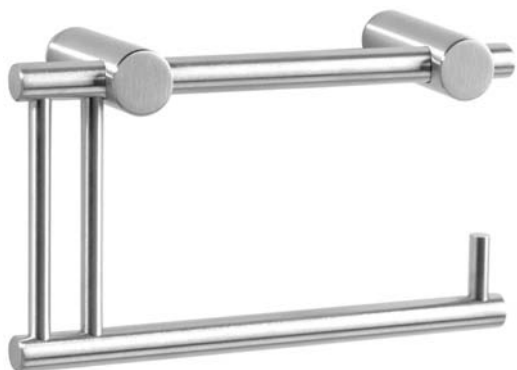

cod.		descripcion
40010	1	INOX MATE

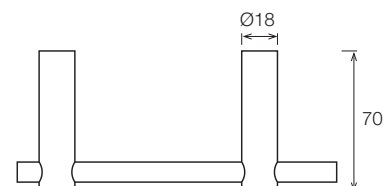
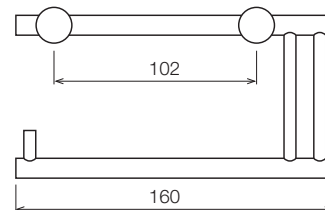

ku-10

serie
kursaal



cod.		descripcion
41007	1	INOX MATE

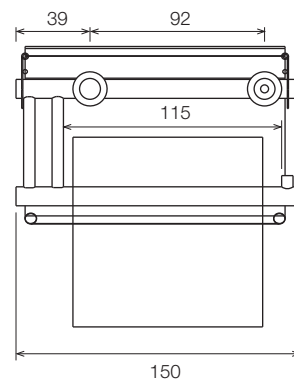
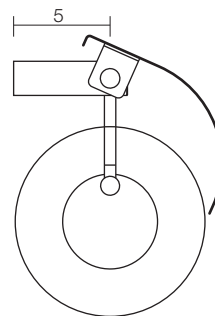

ku-02

serie
kursaal



cod.	A		descripcion
40020	500	1	INOX MATE
40021	980	1	INOX MATE

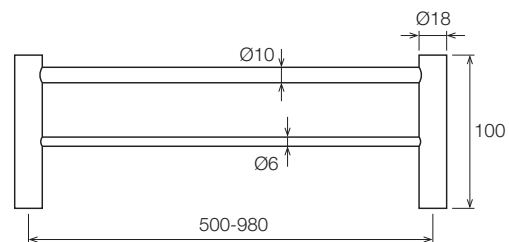

ku-20

serie
kursaal



cod.	X		descripcion
41000	300	1	INOX MATE
41001	400	1	INOX MATE
41002	500	1	INOX MATE

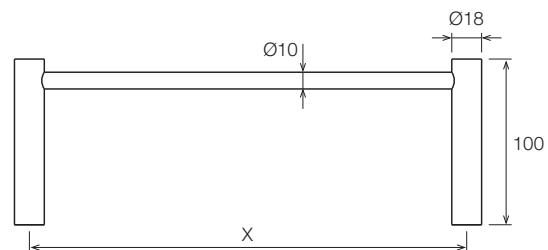

ku-03

serie
kursaal



cod.		descripcion
40030	1	INOX MATE

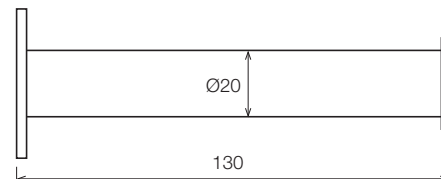

ku-04

serie
kursaal



cod.  descripcion

40041 1 INOX MATE

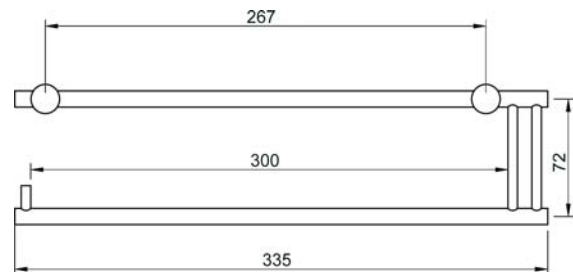

ku-30

serie
kursaal



cod.		descripcion
40035	1	INOX MATE

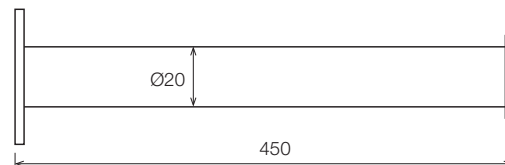

ku-05

serie kursaal



cod.	C		descripcion
40051	130	1	INOX MATE
40052	170	1	INOX MATE
40053	320	1	INOX MATE
40054	640	1	INOX MATE

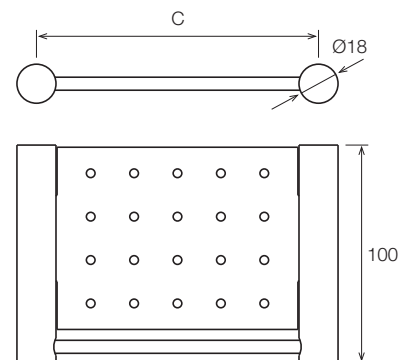

ku-05 90°

serie
kursaal



cod.  description

40055 1 INOX MATE

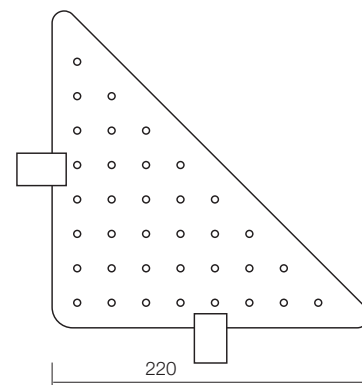

ku-06

serie
kursaal



cod.	L	
40061	220	1
40062	400	1

INOX MATE

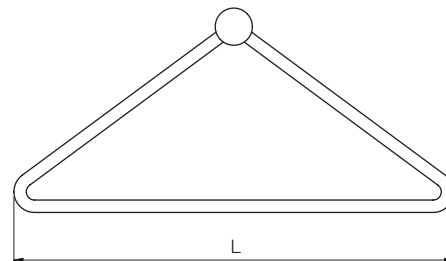

ku-07

serie
kursaal



cod.		descripcion
40070	1	INOX MATE

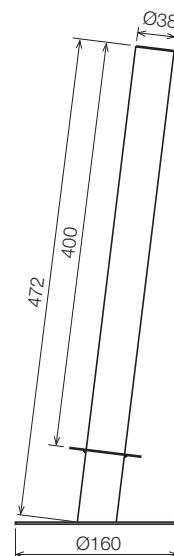

ku-08

serie
kursaal



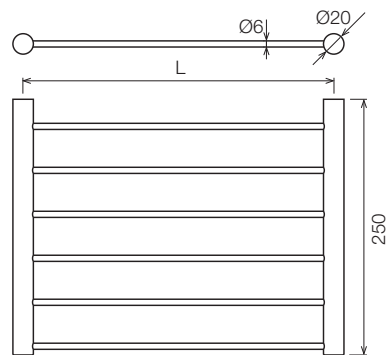

cod.	L		descripcion
40080	450	1	INOX MATE
40081	600	1	INOX MATE

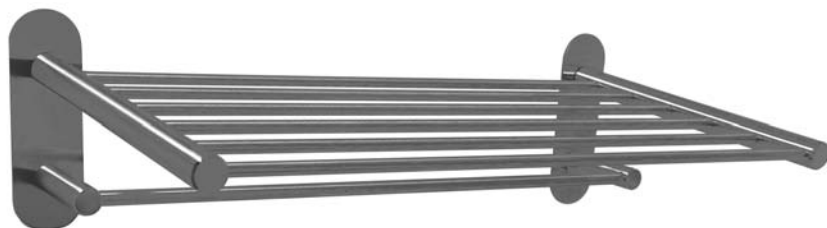

ku-80

serie kursaal



cod.	L		descripcion
40082	450	1	INOX MATE
40083	600	1	INOX MATE

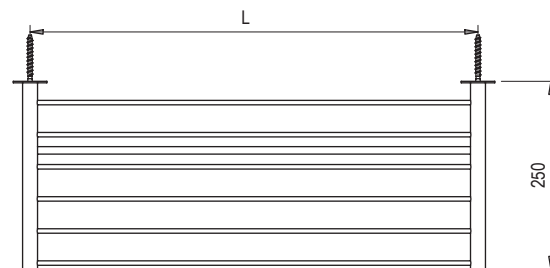
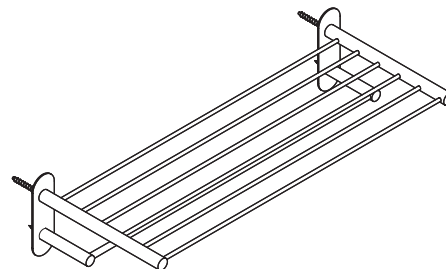

ku-09

serie
kursaal



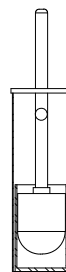
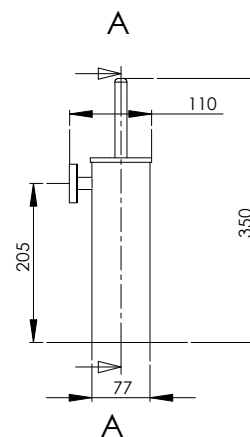

cod.		descripcion
40090	1	INOX MATE

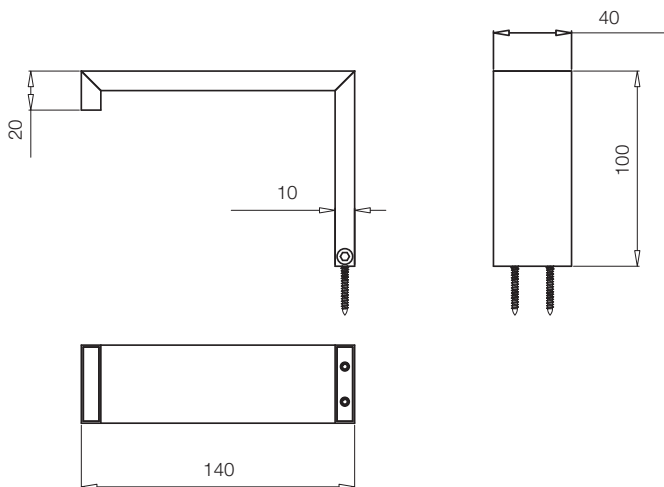

SECCIÓN A-A

big-01



cod.	L		descripcion
41201	140	1	INOX MATE

Combina con serie Big pg. 59.

Matches with Big series pg. 59

Il combine avec Big pg. 59.

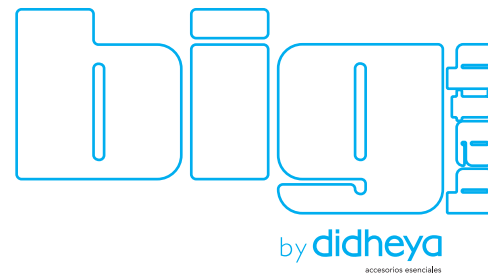

big-05

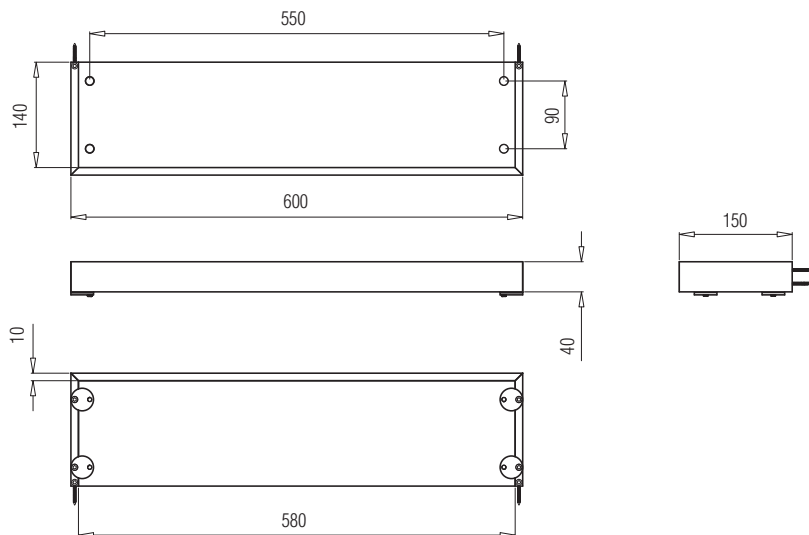

cod.	L		descripcion
41211	600	1	INOX MATE

Combina con serie Big pg. 59.

Matches with Big series pg. 59

Il combine avec Big pg. 59.

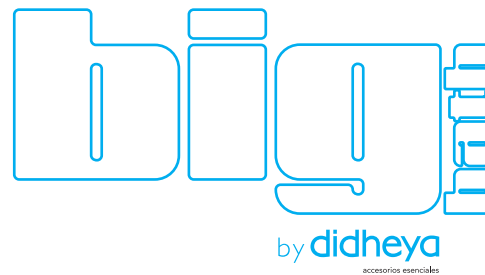

big-06

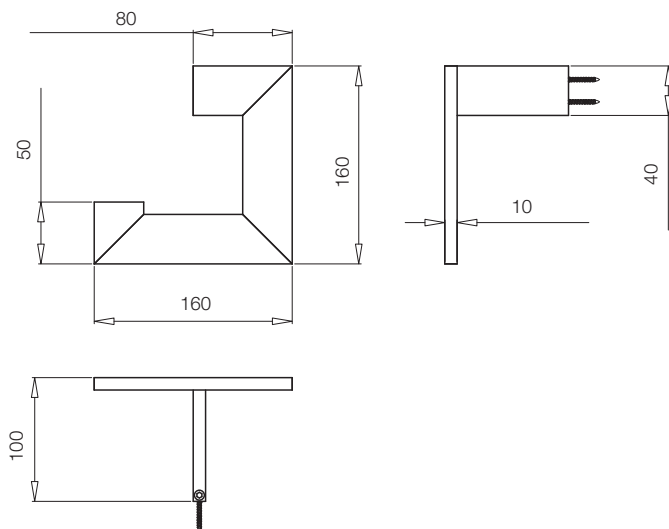
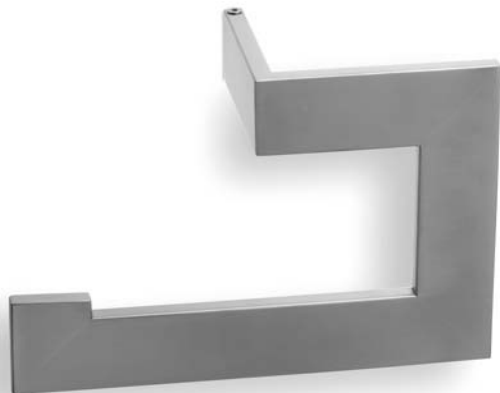

cod.	L		descripcion
41210	240	1	INOX MATE

Combina con serie Big pg. 59.

Matches with Big series pg. 59

Il combine avec Big pg. 59.

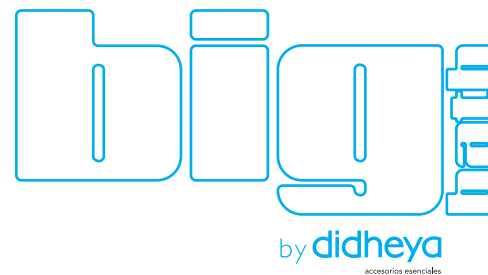

big-09



cod.	L		descripcion
41215	400	1	INOX MATE

Combina con serie Big pg. 59.

Matches with Big series pg. 59

Il combine avec Big pg. 59.

big
by **didheya**
accesorios esenciales

big-12

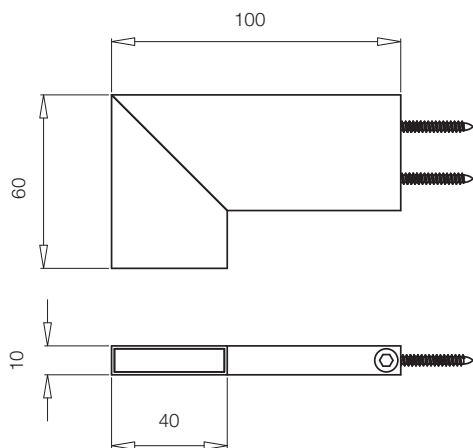

cod.	L		descripcion
41200	100	1	INOX MATE

Combina con serie Big pg. 59.

Matches with Big series pg. 59

Il combine avec Big pg. 59.

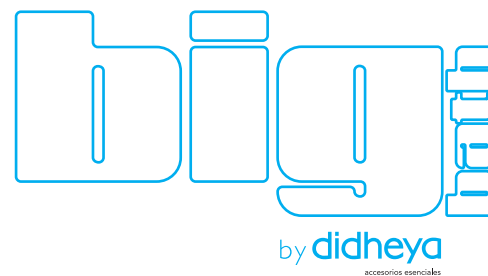

big-20

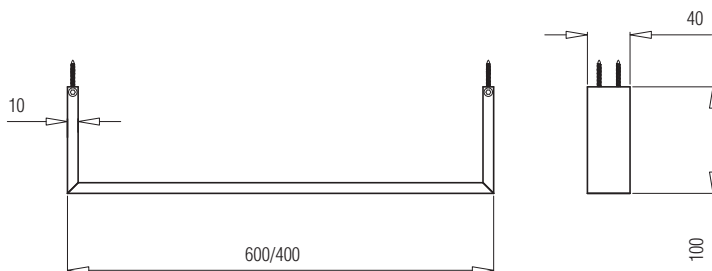
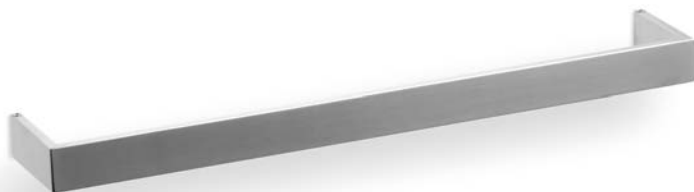

cod.	L		descripcion
41205	400	1	INOX MATE
41207	600	1	INOX MATE

Combina con serie Big pg. 59.

Matches with Big series pg. 59

Il combine avec Big pg. 59.

big
by **didheya**
accesorios esenciales

i-126 d FOR GLASS DOOR

cod.		descripcion
41126	1	INOX MATE

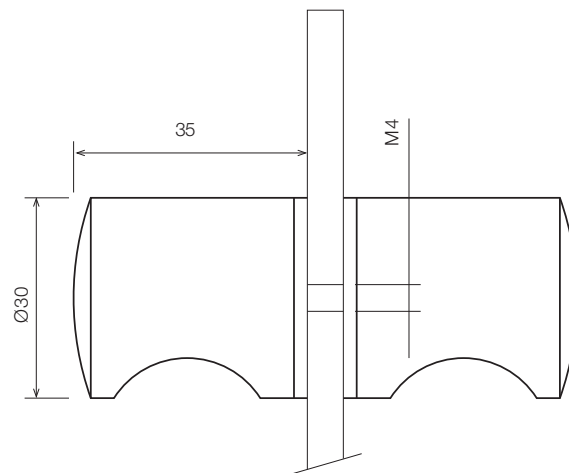

i-129 d FOR GLASS DOOR

cod.		descripcion
41129	1	INOX MATE

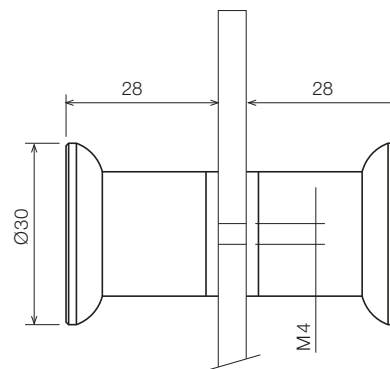

perchas
hook & hook rack
patéres

AISI 303-304



percha 1



cod.		descripcion
92001	25	INOX MATE

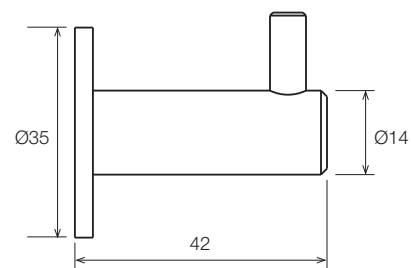

percha 129

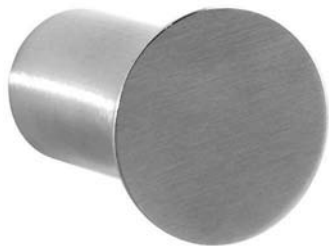

cod.		descripcion
92010	25	INOX MATE

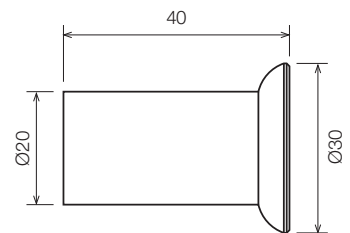

percha 4



cod.		descripcion
92006	25	INOX MATE

KUBE

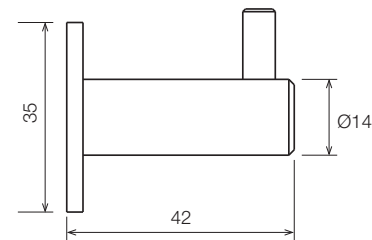

percha 5



cod.	Ø		descripcion
92004	20	25	INOX MATE
92005	25	25	INOX MATE

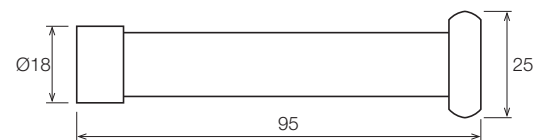
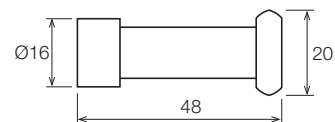

perchero 5



cod.	L	H		descripcion
92102	45	145	1	INOX MATE

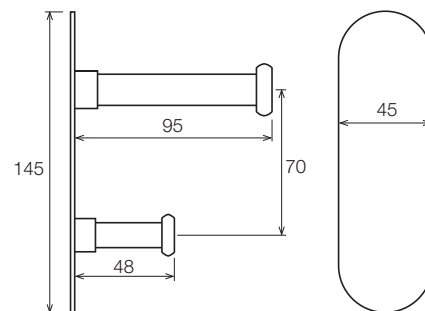

px 201



cod.	Descripcion	
92012	px 201	25

INOX MATE

eccentric

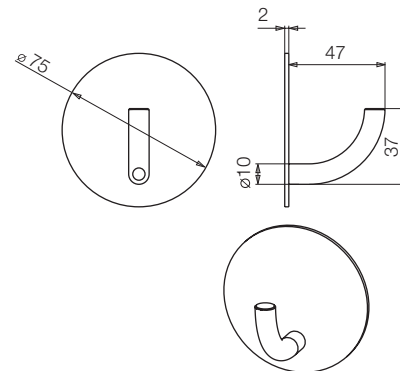

px 131



cod.	Descripcion	
92013	px 131	25

INOX MATE

eccentric

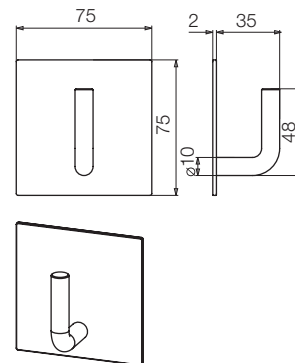

px 334



cod.	Descripcion	
------	-------------	---

92014	px 334	25
-------	--------	----

INOX MATE

eccentric

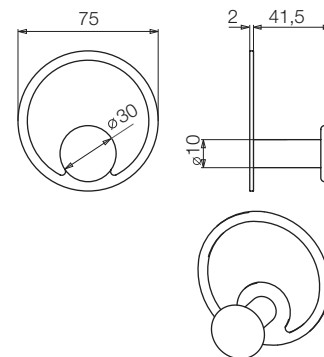

px 437



cod.	Descripcion	
------	-------------	---

92015	px 437	25
-------	--------	----

INOX MATE

eccentric

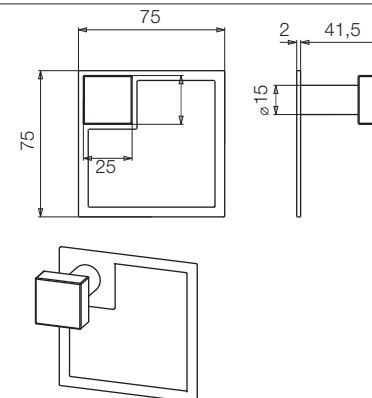

px 001



cod.	Descripcion	
92016	px 001	25

INOX MATE

eccentric

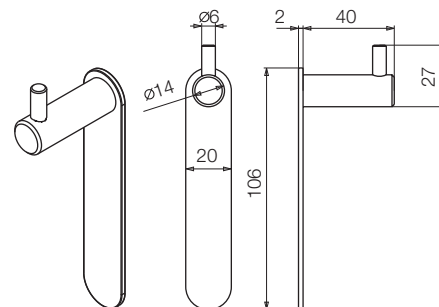

px 004



cod.	Descripcion	
92017	px 004	25

INOX MATE

eccentric

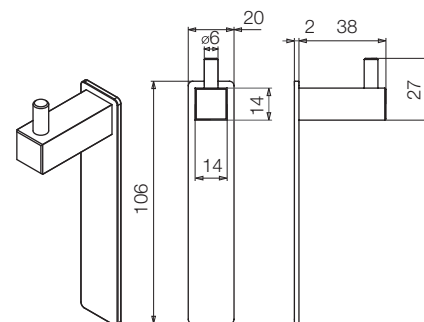

px 337



cod.	Descripcion	
92018	px 337	25

INOX MATE

eccentric

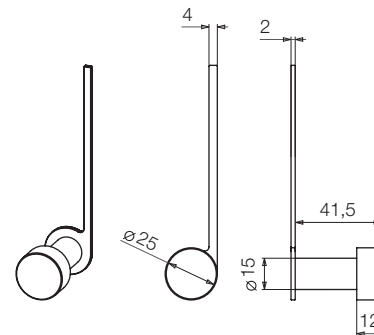

px 340



cod.	Descripcion	
92019	px 340	25

INOX MATE

eccentric

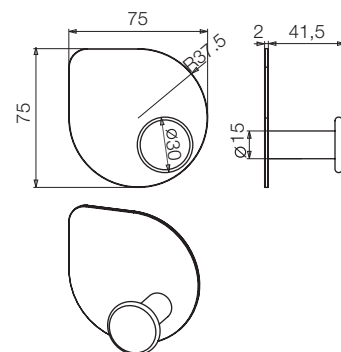

px 3340



cod.	Descripcion	
92103	px 3340	2
INOX MATE		

eccentric

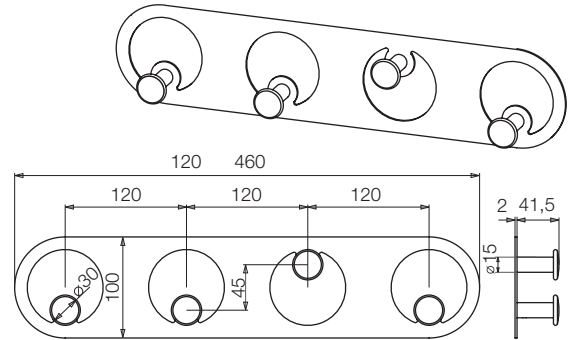

px 4370



cod.	Descripcion	
92104	px 4370	2
INOX MATE		

eccentric

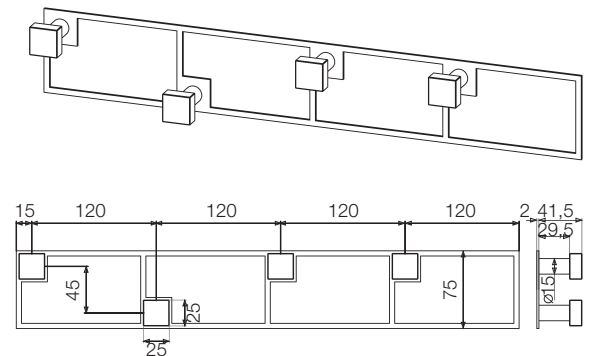

señalética
signage
signalétique

AISI 303-304

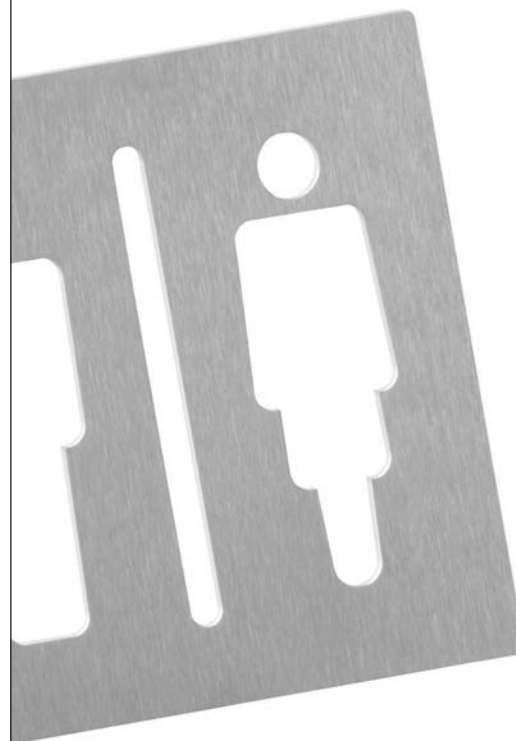

señalética



cod. L H 



95006 60 60 10
95106 150 150 2
INOX MATE



95007 60 60 10
95107 150 150 2
INOX MATE



95008 60 60 10
95108 150 150 2
INOX MATE



95009 60 60 10
95109 150 150 2
INOX MATE



95010 60 60 10
95110 150 150 2
INOX MATE



95011 60 60 10
95111 150 150 2
INOX MATE



95012 60 60 10
95112 150 150 2
INOX MATE



95013 60 60 10
95113 150 150 2
INOX MATE



95038 60 60 10
95138 150 150 2
INOX MATE

cod. L H 



95000 60 60 10
95100 150 150 2
INOX MATE



95001 60 60 10
95101 150 150 2
INOX MATE



95002 60 60 10
95102 150 150 2
INOX MATE



95003 60 60 10
95103 150 150 2
INOX MATE



95004 60 60 10
95104 150 150 2
INOX MATE



95005 60 60 10
95105 150 150 2
INOX MATE

señalética



cod. L H



95206 100 100 10
INOX MATE



95207 100 100 10
INOX MATE



95208 100 100 10
INOX MATE



95209 100 100 10
INOX MATE

cod. L H



95200 100 100 10
INOX MATE



95210 100 100 10
INOX MATE



95201 100 100 10
INOX MATE



95211 100 100 10
INOX MATE



95202 100 100 10
INOX MATE



95212 100 100 10
INOX MATE



95203 100 100 10
INOX MATE



95213 100 100 10
INOX MATE



95204 100 100 10
INOX MATE



95214 100 100 10
INOX MATE



95205 100 100 10
INOX MATE



95215 100 100 10
INOX MATE

índice de códigos

index of codes

indice de codes

Code	Página	Code	Página	Code	Página	Code	Página	Code	Página
10010	13	12050	14	14010	15	21020	10	23225	12
10015	13	12055	14	14015	15	21025	10	23230	12
10020	13	12060	14	14020	15	21030	10	23250	12
10025	13	12065	14	14025	15	21110	10	24115	20
10030	13	12070	14	14030	15	21115	10	24120	20
10035	13	12075	14	14035	15	21120	10	24125	20
10040	13	12080	14	14040	15	21125	10	24130	20
10045	13	12085	14	14050	15	21130	10	24145	20
10050	13	12090	14	14055	15	21135	10	24150	20
10055	13	12095	14	14060	15	21140	10	24160	20
10060	13	12100	14	14065	15	21145	10	24175	20
10065	13	12105	14	14075	15	21150	10	24196	20
10070	13	12110	14	14090	15	21155	10	24420	22
10075	13	12115	14	14100	15	21165	10	24425	22
10080	13	12120	14	14105	15	21180	10	24430	22
10085	13	12125	14	14115	15	22010	11	24446	22
10090	13	12130	14	14130	15	22015	11	24450	22
10095	13	12135	14	14135	15	22020	11	24453	22
10100	13	12139	14	14139	15	22100	17	24461	22
10105	13	12140	14	14145	15	22101	17	24477	22
10110	13	12145	14	14167	15	22102	17	24493	22
10115	13	12160	14	14172	15	22104	18	24497	22
10120	13	12167	14	15001	5	22210	19	24601	7
10125	13	12172	14	15015	5	22215	19	24615	7
10130	13	12415	26	15020	5	22220	19	24620	7
10135	13	12420	26	15025	5	23015	12	24625	7
10140	13	12425	26	15030	5	23020	12	24630	7
10160	13	12430	26	15030	5	23025	12	24650	7
12010	14	12435	26	15080	5	23030	12	24680	7
12015	14	12440	26	20015	8	23040	12	24701	6
12020	14	12445	26	20020	8	23050	12	24715	6
12025	14	12450	26	20115	9	23080	12	24720	6
12030	14	12460	26	20120	9	23115	12	24725	6
12035	14	12475	26	20125	9	23120	12	24730	6
12040	14	12480	26	21010	10	23125	12	24750	6
12045	14	12500	26	21015	10	23130	12	24780	6

Code	Página	Code	Página	Code	Página	Code	Página	Code	Página
26215	27	31020	49	33515	54	40030	131	42325	63
26220	27	31025	49	33520	54	40035	133	42330	63
26225	27	31030	49	33525	54	40041	132	42335	63
26230	27	31035	49	33615	55	40051	134	42345	63
26235	27	31220	49	33620	55	40052	134	42360	63
26250	27	31225	49	33625	55	40053	134	42365	63
26280	27	31230	49	33715	55	40054	134	42415	69
26296	27	31310	50	33720	55	40055	135	42420	69
26323	27	31315	50	33725	55	40061	136	42430	69
26420	27	31320	50	33820	56	40062	136	42520	69
26425	27	31325	50	33825	56	40070	137	42525	69
26430	27	31330	50	33915	56	40080	138	42530	69
26435	27	31335	50	33920	56	40081	138	42625	69
26450	27	31560	85	33925	56	40082	139	42630	69
26480	27	32017	50	34000	58	40083	139	42635	69
27215	21	32112	51	34010	57	40090	140	42660	69
27220	21	32211	51	34015	57	41000	130	42830	71
27230	21	32312	52	34020	57	41001	130	42850	71
27253	21	32316	52	34025	57	41002	130	43000	65
27277	21	32320	52	34110	57	41007	128	43020	65
27294	21	32325	52	34115	57	41126	147	43025	65
30025	47	32330	52	34120	57	41129	148	43030	65
30030	47	32530	52	34125	57	41200	145	43050	65
30035	47	32535	52	34285	97	41201	141	43080	65
30110	47	32545	52	35005	24	41205	146	43125	66
30115	47	32610	53	35015	24	41207	146	43130	66
30120	47	32615	53	35020	24	41210	143	43135	66
30125	47	32620	53	35025	24	41211	142	43145	66
30130	47	32625	53	35030	24	41215	144	43160	66
30140	47	32710	53	35035	24	42115	63	43165	66
30150	47	32715	53	35040	24	42120	63	43325	68
30215	48	32720	53	35055	24	42125	63	43330	68
30218	48	32725	53	35085	24	42130	63	43335	68
30221	48	33415	54	40010	127	42220	63	43360	68
30325	48	33420	54	40020	129	42225	63	43365	68
30330	48	33425	54	40021	129	42230	63	44015	73

Code	Página	Code	Página	Code	Página	Code	Página	Code	Página
44020	73	46009	76	51225	63	53010	81	53518	103
44030	73	46010	76	51230	63	53012	81	53519	103
44120	73	46011	76	51320	63	53035	81	53520	103
44125	73	46012	76	51325	63	53040	81	53521	106
44130	73	46013	76	51330	63	53045	81	53522	106
44225	73	46014	76	51425	63	53050	81	53523	106
44230	73	50015	69	51430	63	53060	81	53524	106
44235	73	50020	69	51435	63	53100	86	53525	106
44260	73	50030	69	51445	63	53200	62	53526	106
44320	72	50115	69	51460	63	53201	62	53527	108
44325	72	50120	69	51465	63	53300	96	53528	108
44330	72	50130	69	51525	63	53310	88	53529	108
44430	72	50220	69	51530	63	53335	88	53556	82
44435	72	50225	69	51535	63	53340	88	53557	83
44450	72	50230	69	51545	63	53345	88	53558	82
44460	72	50320	69	51560	63	53350	88	53559	83
44520	61	50325	69	51565	63	53410	99	53606	89
44530	61	50330	69	52025	64	53435	99	53607	90
44550	61	50425	69	52030	64	53440	99	53608	89
45125	64	50430	69	52035	64	53445	99	53609	90
45130	64	50435	69	52045	64	53450	99	53661	84
45135	64	50460	69	52060	64	53500	104	53663	84
45145	64	50525	69	52065	64	53501	104	53701	91
45160	64	50530	69	52125	64	53502	104	53702	91
45165	64	50535	69	52130	64	53503	108	53703	91
45220	67	50560	69	52135	64	53504	108	53704	91
45225	67	50830	71	52145	64	53505	108	53705	91
45250	67	50850	71	52160	64	53506	110	53710	92
45430	70	50930	71	52165	64	53507	110	53711	93
45450	70	50950	71	52220	67	53508	110	53712	94
46000	75	51015	63	52225	67	53509	110	53713	94
46001	75	51020	63	52250	67	53510	110	53714	94
46002	75	51025	63	52320	67	53511	110	53715	94
46003	75	51030	63	52325	67	53512	104	53721	95
46004	75	51115	63	52350	67	53513	104	53722	95
46005	75	51120	63	52430	70	53514	104	53723	95
46006	75	51125	63	52450	70	53515	103	53726	95

Code	Página	Code	Página	Code	Página	Code	Página	Code	Página
53731	95	54530	68	58425	73	60410	44	70151	32
53732	95	54535	68	58430	73	60415	44	70152	32
53733	95	54560	68	58435	73	60420	44	70154	32
53736	95	54565	68	58460	73	60425	44	70161	32
53737	95	57020	72	58525	73	60430	44	70162	32
53738	95	57025	72	58530	73	60435	44	70164	32
54000	65	57030	72	58535	73	60450	44	70171	32
54020	65	57120	72	58560	73	60480	44	70172	32
54025	65	57125	72	60101	40	61215	39	70174	32
54030	65	57130	72	60110	40	61220	39	70181	32
54050	65	57230	72	60115	40	61225	39	70182	32
54080	65	57235	72	60120	40	61230	39	70184	32
54100	65	57250	72	60125	40	61235	39	70201	32
54120	65	57260	72	60130	40	61250	39	70202	32
54180	65	57330	72	60135	40	70000	30	70204	32
54125	65	57335	72	60150	40	70001	30	70211	32
54130	65	57350	72	60180	40	70002	30	70212	32
54150	65	57360	72	60201	41	70003	30	70214	32
54225	66	57420	61	60210	41	70080	31	70221	33
54230	66	57430	61	60215	41	70081	31	70222	33
54235	66	57450	61	60220	41	70082	31	70223	33
54245	66	57520	61	60225	41	70090	31	70231	33
54260	66	57530	61	60230	41	70091	31	70232	33
54265	66	57550	61	60235	41	70092	31	70233	33
54325	66	58015	73	60250	41	70100	31	70241	33
54330	66	58020	73	60280	41	70101	31	70242	33
54335	66	58030	73	60301	43	70102	31	70243	33
54345	66	58115	73	60310	43	70110	31	70251	33
54360	66	58120	73	60315	43	70111	31	70252	33
54365	66	58130	73	60320	43	70112	31	70253	33
54425	68	58220	73	60325	43	70130	31	70271	33
54430	68	58225	73	60330	43	70131	31	70272	33
54435	68	58230	73	60335	43	70132	31	70273	33
54460	68	58320	73	60350	43	70140	31	70281	33
54465	68	58325	73	60380	43	70141	31	70282	33
54525	68	58330	73	60401	44	70142	31	70283	33

Code	Página	Code	Página	Code	Página	Code	Página	Code	Página
70290	35	70440	30	90120	121	93200	16	95038	164
70291	35	70441	30	90124	121	93303	123	95100	164
70292	35	70442	30	90130	121	93400	16	95101	164
70300	36	70443	30	90220	121	93401	16	95102	164
70301	36	80930	70	90225	121	94002	74	95103	164
70302	36	80950	70	90230	121	94004	74	95104	164
70310	36	88570	29	91020	112	94005	74	95105	164
70311	36	88572	29	91035	112	94102	74	95106	164
70312	36	88575	29	91040	115	94104	74	95107	164
70320	36	88580	29	91100	113	94105	74	95108	164
70321	36	88582	29	91101	113	94202	74	95109	164
70322	36	88585	29	91102	113	94204	74	95110	164
70330	36	88590	29	91220	114	94205	74	95111	164
70331	36	88592	29	91235	114	94302	74	95112	164
70332	36	88595	29	92001	152	94304	74	95113	164
70350	36	88620	28	92004	155	94402	74	95138	164
70351	36	88622	28	92005	155	94404	74	95200	165
70352	36	88625	28	92006	154	94502	74	95201	165
70360	36	88630	28	92010	153	94504	74	95202	165
70361	36	88632	28	92012	157	94505	74	95203	165
70362	36	88635	28	92013	157	94507	74	95204	165
70380	37	88640	28	92014	158	94509	74	95205	165
70381	37	88642	28	92015	158	95000	164	95206	165
70382	37	88645	28	92016	159	95001	164	95207	165
70390	37	88710	77	92017	159	95002	164	95208	165
70391	37	88711	77	92018	160	95003	164	95209	165
70392	37	88712	77	92019	160	95004	164	95210	165
70400	37	88713	77	92102	156	95005	164	95211	165
70401	37	88714	77	92103	161	95006	164	95212	165
70402	37	88715	77	92104	161	95007	164	95213	165
70420	37	88716	77	93001	116	95008	164	95214	165
70421	37	88717	77	93002	117	95009	164	95215	165
70422	37	90012	121	93003	118	95010	164	OCU10	111
70430	37	90015	121	93101	16	95011	164	OCU20	111
70431	37	90020	121	93102	16	95012	164	OCU30	111
70432	37	90115	121	93103	16	95013	164	OCU40	111
								OCU50	111



Tel.: +34 943 610 052
Fax: +34 943 610 173

info@didheya.es
www.didheya.com

Ezurriki kalea E-20
E-20305 Irun, Spain.