



MADE  
IN ITALY

PBA  
ALUMINIUM



ALUMINIUM

**PBA ALUMINIUM, maniglie e maniglioni  
con finitura anodizzata.**

**Eleganza su misura.**

**PBA ALUMINIUM, lever handles and pull  
handles with anodized finish.**

**Elegance tailor-made**

**PBA ALUMINIUM béquilles et poignées  
en finition anodisée.**

**Élégance sur mesure**

**PBA ALUMINIUM, Türdrücker und  
Stosgriffe in anodisierter Ausführung.**

**Maßgeschneidert Eleganz.**



# MATERIALS AND FINISHING

## ALUMINIUM ANODIZED SATIN



SILVER

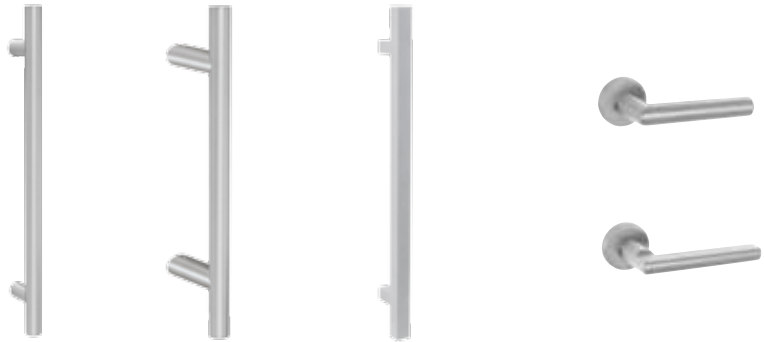

BRONZE

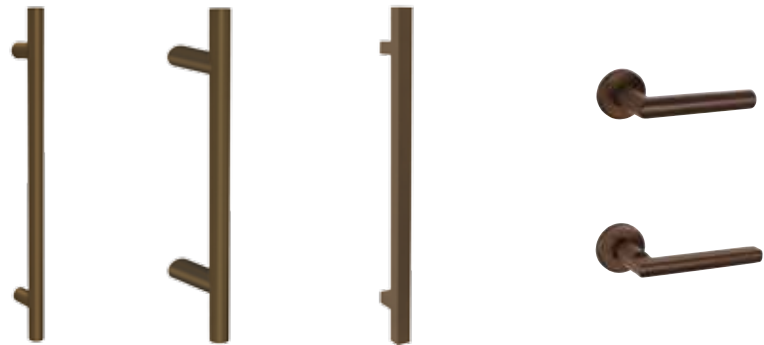

BLACK







PULL HANDLES

Aluminium







PULL HANDLES

Aluminium



PROGRAMMA 2000A



LEVER HANDLES

Aluminium

**POSTER**



LOG SERVICE

Aluminium

LA COLLEZIONE

THE COLLECTION

LA COLLECTION

DIE KOLLEKTION

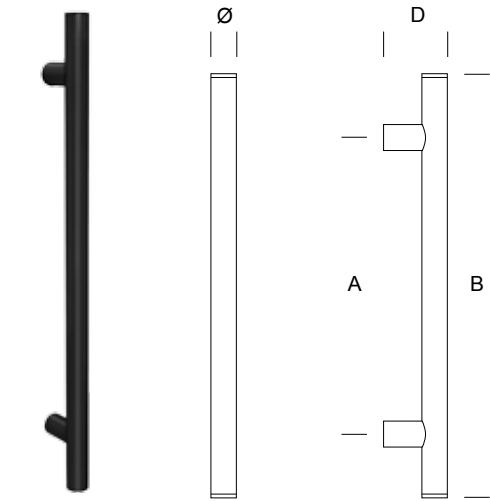

ITEM	A	B	Ø	D
2AT.242.0025 .xx	250 mm 9 7/8"	400 mm 15 3/4"	25 mm 1"	70 mm 2 3/4"
2AT.243.0030 .xx	300 mm 11 13/16"	450 mm 17 3/4"	25 mm 1"	70 mm 2 3/4"
* 2AT.243.9999 .xx	custom	custom	25 mm 1"	70 mm 2 3/4"
* Supporto aggiuntivo necessario per A > 500 mm - The additional support is necessary for A > 500 mm				
2AT.252.0030 .xx	300 mm 11 3/16"	450 mm 17 3/4"	30 mm 1 3/16"	75 mm 2 15/16"
2AT.253.0035 .xx	350 mm 13 25/32"	500 mm 19 11/16"	30 mm 1 3/16"	75 mm 2 15/16"
* 2AT.253.9999 .xx	custom	custom	30 mm 1 3/16"	75 mm 2 15/16"
* Supporto aggiuntivo necessario per A > 600 mm - The additional support is necessary for A > 600 mm				
2AT.225.0035 .xx	350 mm 13 25/32"	520 mm 20 1/2"	35 mm 1 3/8"	80 mm 3 1/8"
2AT.226.0055 .xx	550 mm 21 21/32"	720 mm 28 11/32"	35 mm 1 3/8"	80 mm 3 1/8"
* 2AT.226.9999 .xx	custom	custom	35 mm 1 3/8"	80 mm 3 1/8"
* Supporto aggiuntivo necessario per A > 800 mm - The additional support is necessary for A > 800 mm				

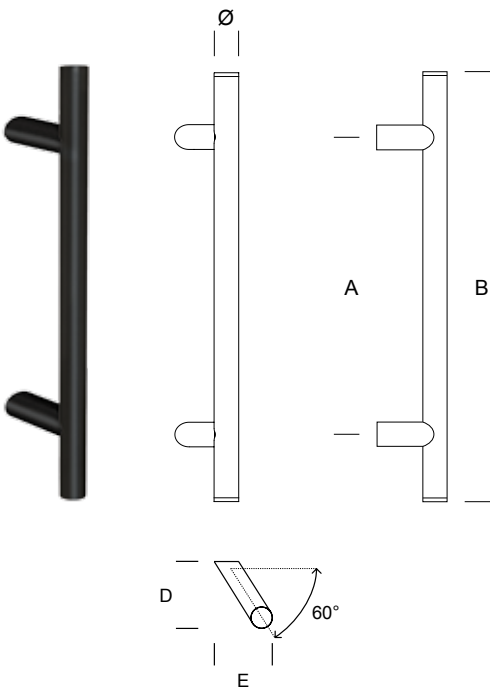

ITEM	A	B	Ø	D	E
2AT.242.025I .xx	250 mm 9 7/8"	400 mm 15 3/4"	25 mm 1"	84 mm 3 5/16"	68 mm 2 11/16"
2AT.243.030I .xx	300 mm 11 13/16"	450 mm 17 3/4"	25 mm 1"	84 mm 3 5/16"	68 mm 2 11/16"
* 2AT.243.999I .xx	custom	custom	25 mm 1"	84 mm 3 5/16"	68 mm 2 11/16"
* Supporto aggiuntivo necessario per A > 500 mm - The additional support is necessary for A > 500 mm					
2AT.252.030I .xx	300 mm 11 13/16"	450 mm 17 3/4"	30 mm 1 3/16"	88 mm 3 1/2"	74 mm 2 29/32"
2AT.253.035I .xx	350 mm 13 25/32"	500 mm 19 11/16"	30 mm 1 3/16"	88 mm 3 1/2"	74 mm 2 29/32"
* 2AT.253.999I .xx	custom	custom	30 mm 1 3/16"	88 mm 3 1/2"	74 mm 2 29/32"
* Supporto aggiuntivo necessario per A > 600 mm - The additional support is necessary for A > 600 mm					

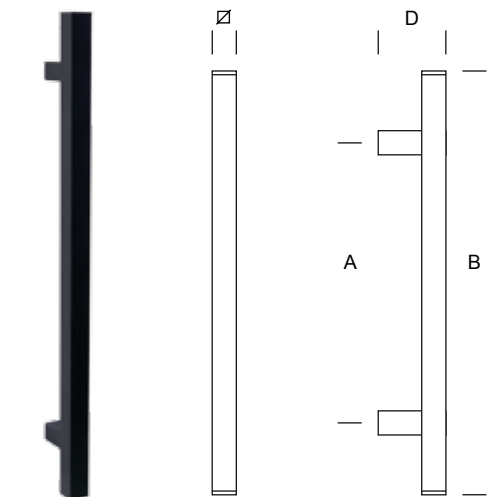

ITEM	A	B	Ø	D
2AQ.111.0030 .xx	300 mm 11 13/16"	450 mm 17 3/4"	25 mm 1"	70 mm 2 3/4"
2AQ.112.0035 .xx	350 mm 13 25/32"	500 mm 19 11/16"	25 mm 1"	70 mm 2 3/4"
* 2AQ.112.9999 .xx	custom	custom	25 mm 1"	70 mm 2 3/4"
* Supporto aggiuntivo necessario per A > 650 mm - The additional support is necessary for A > 650 mm				
2AQ.121.0050 .xx	500 mm 19 11/16"	650 mm 25 5/8"	30 mm 1 3/16"	75 mm 2 15/16"
* 2AQ.121.9999 .xx	custom	custom	30 mm 1 3/16"	75 mm 2 15/16"
* Supporto aggiuntivo necessario per A > 800 mm - The additional support is necessary for A > 800 mm				
2AQ.131.0060 .xx	600 mm 23 5/8"	770 mm 30 5/16"	35 mm 1 3/8"	80 mm 3 1/8"
* 2AQ.131.9999 .xx	custom	custom	35 mm 1 3/8"	80 mm 3 1/8"
* Supporto aggiuntivo necessario per A > 1000 mm - The additional support is necessary for A > 1000 mm				



\* Supporto aggiuntivo necessario per le misure contraddistinte da \*, in mancanza di tale supporto la tenuta non viene garantita da pba  
 \* The additional support is necessary for all the products marked with \*, if the customer does not accept the additional support pba cannot guarantee the security and the duration of the fixing

LOG SERVICE STANDARD



Esempio scritta su profilo tondo in alluminio

Example of writing on round aluminium profile

Exemple d'écriture sur profil aluminium rond

Beispiel für die Beschriftung von rundem Aluminiumprofil

ITEM  
2CC.LOG.0001.00

Scritta di taglio laser passante  
Font: Arial, Stile: Regular, Dimensione = 10 pt, Spaziatura = 12 pt  
Numero caratteri illimitato

Through laser cut writing  
Font: Arial, Type: Regular, Size = 10 pt, Space = 12 pt  
No limit of alphanumeric characters

Écriture avec découpe au laser et traversante  
Font: Arial, Type: Regular, Dimension = 10 pt, Espace = 12 pt  
Nombre illimité de caractères

Lasergeschnittene Schrift  
Schriftart: Arial, Typ: Regular, Maß=10 pt, Abstand=12 pt  
Sämtliche alphanumerische Zeichen verfügbar

LOG SERVICE CUSTOM



Esempio logo su profilo quadro in acciaio satinato

Example of logo on square satinated stainless steel profile

Exemple de logo sur profil en acier inox satiné carré

Beispiel für ein Logo auf quadratischem, satiniertem Edelstahlprofil

ITEM  
2CC.LOG.9999.00

Scritta o logo di taglio laser - Font e misure a scelta  
Numero caratteri illimitato  
Disegno fornito da cliente.  
pba si riserva di valutare la fattibilità

Laser cut writing or Logo - Customized font and sizes  
No limit of alphanumeric characters  
The drawing must be submitted by the customer.  
pba reserves the right to evaluate the feasibility

Écriture ou logo découpée au laser - Font et dimension personnalisées  
Nombre illimité de caractères  
Le dessin doit être présenté par le client.  
pba se réserve le droit d'évaluer la faisabilité

Lasergeschnittene Schrift oder Logo – Spezialanfertigung von Schriftart und Maß nach Kundenwunsch möglich.  
Sämtliche alphanumerische Zeichen verfügbar  
Die Zeichnung/Beschriftung muss vom Kunden eingereicht werden.  
Pba behält sich das Recht vor, die Umsetzung vorab zu prüfen.

HOW TO ORDER

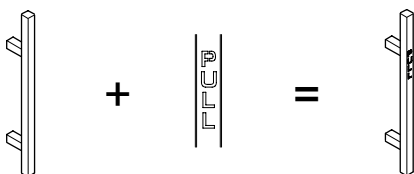

2CC.LOG.0001.00

Aluminium



Bronze .67 Black .68 Silver .69



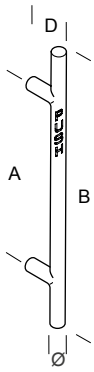

ITEM	A	B	Ø	D	LOG SERVICE STANDARD	LOG SERVICE CUSTOM
2AT.253.9999 .xx	custom	custom	30 mm 1 3/16"	75 mm 2 15/16"	+ 2CC.LOG.0001.00	+ 2CC.LOG.9991.00
Supporto aggiuntivo necessario per A > 600 mm - 23 5/8" The additional support is necessary for A > 600 mm - 23 5/8"						
2AT.226.9999 .xx	custom	custom	35 mm 1 3/8"	80 mm 3 1/8"	+ 2CC.LOG.0001.00	+ 2CC.LOG.9991.00
Supporto aggiuntivo necessario per A > 800 mm - 31 1/2" The additional support is necessary for A > 800 mm - 31 1/2"						

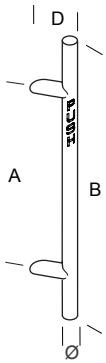
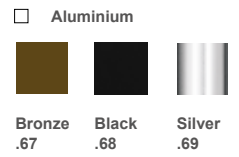

ITEM	A	B	Ø	D	E	LOG SERVICE STANDARD	LOG SERVICE CUSTOM
2AT.253.9991 .xx	custom	custom	30 mm 1 3/16"	88 mm 3 1/2"	74 mm 2 29/32"	+ 2CC.LOG.0001.00	+ 2CC.LOG.9991.00
Supporto aggiuntivo necessario per A > 600 mm - 23 5/8" The additional support is necessary for A > 600 mm - 23 5/8"							

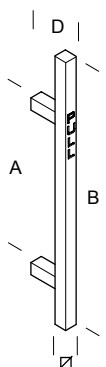
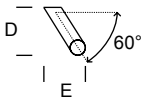
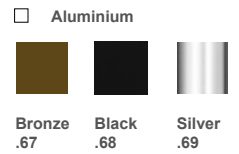

ITEM	A	B	Ø	D	LOG SERVICE STANDARD	LOG SERVICE CUSTOM
2AQ.121.9999 .xx	custom	custom	30 mm 1 3/16"	75 mm 2 15/16"	+ 2CC.LOG.0001.00	+ 2CC.LOG.9991.00
Supporto aggiuntivo necessario per A > 800 mm - 31 1/2" The additional support is necessary for A > 800 mm - 31 1/2"						
2AQ.131.9999 .xx	custom	custom	35 mm 1 3/8"	80 mm 3 1/8"	+ 2CC.LOG.0001.00	+ 2CC.LOG.9991.00
Supporto aggiuntivo necessario per A > 1000 mm - 39 3/8" The additional support is necessary for A > 1000 mm - 39 3/8"						

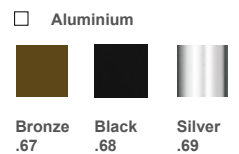

HOW TO ORDER

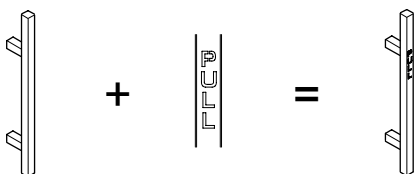

2CC.LOG.0001.00



ITEM. A B  
**2AM.030.00T8** . xx 8 5/16" 65 2 37/64"

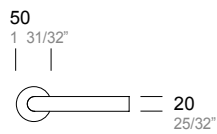

~~**2AM.030.00T4**~~ . xx 4 5/32" 60 2 3/8"  
 Rosetta tonda bassa in acciaio verniciato  
 Rose low round in stainless steel powder coated  
 (Bronze - Black - Silver)

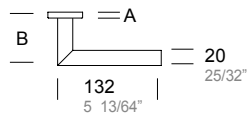

ITEM.  
**2AM.030.0008** . xx

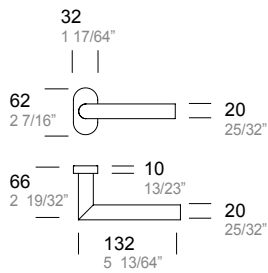

ITEM.  
**2AM.030.00DK** . xx

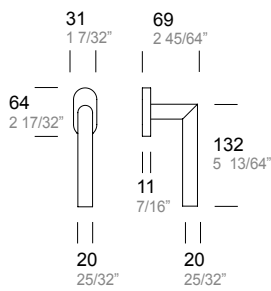

Aluminium



Bronze  
 .67



Black  
 .68



Silver  
 .69

ITEM.  
**2AM.028.0TY8** . xx  
**2AM.028.0TP8** . xx



Aluminium



Bronze  
 .67



Black  
 .68



Silver  
 .69

ITEM.  
**2AM.028.00Y8** . xx  
**2AM.028.00P8** . xx

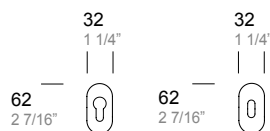



ITEM. A B  
**2AM.173.00T8** . xx 8 5/16" 65 2 37/64"

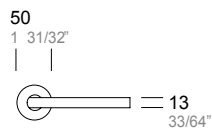

**2AM.173.00T4** . xx 4 5/32" 60 2 3/8"  
 Rosetta tonda bassa in acciaio verniciato  
 Rose low round in stainless steel powder coated  
 (Bronze - Black - Silver)

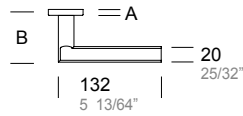

ITEM.  
**2AM.173.0008** . xx

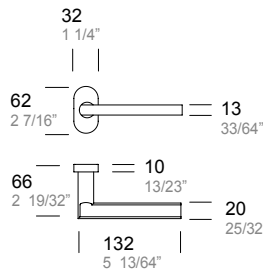

ITEM.  
**2AM.173.00DK** . xx

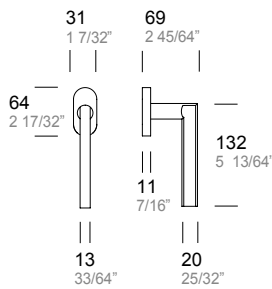

Aluminium



Bronze  
 .67



Black  
 .68



Silver  
 .69

ITEM.  
**2AM.028.0TY8** . xx  
**2AM.028.0TP8** . xx



Aluminium



Bronze  
 .67



Black  
 .68



Silver  
 .69

ITEM.  
**2AM.028.00Y8** . xx  
**2AM.028.00P8** . xx

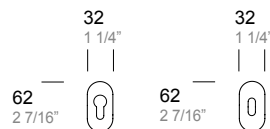

INFORMAZIONI TECNICHE

TECHNICAL INFORMATION

INFORMATIONS TECHNIQUES

TECHNISCHE INFORMATIONEN

FISSAGGI D - FIXINGS D - FIXATIONS D - BEFESTIGUNGEN D - BEVESTIGING D

ART.  
FIX.210.000D.B2

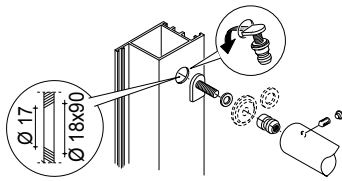

- SINGOLO NON PASSANTE PER PROFILO TUBOLARE
- SINGLE NON THROUGH FITTING FOR TUBULAR PROFILE
- FIXATION SIMPLE NON TRAVERSANT POUR PROFIL TUBULAIRE
- BEFESTIGUNG EINSEITIG UNSICHTBAR FÜR 1-KAMMER KUNSTSTOFFTÜREN
- ENKELE NIET-DOORGAANDE BEVESTIGING VOOR PROFIELEN

ART.  
FIX.310.000D.B2

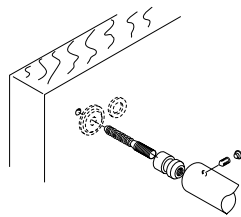

- SINGOLO NON PASSANTE PER LEGNO
- SINGLE NON THROUGH FITTING FOR WOOD
- FIXATION SIMPLE NON TRAVERSANT POUR BOIS
- BEFESTIGUNG EINSEITIG UNSICHTBAR FÜR HOLZTÜREN
- ENKELE NIET-DOORGAANDE BEVESTIGING VOOR HOUT

ART.  
FIX.410.000D.B2  
A= 33 mm  
FIX.410.00DL.B2  
A= 50 mm

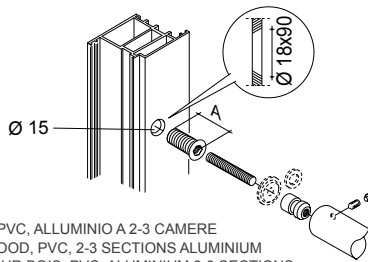

- SINGOLO NON PASSANTE PER LEGNO, PVC, ALLUMINIO A 2-3 CAMERE
- SINGLE NON THROUGH FITTING FOR WOOD, PVC, 2-3 SECTIONS ALUMINIUM
- FIXATION SIMPLE NON TRAVERSANT POUR BOIS, PVC, ALUMINIUM 2-3 SECTIONS
- EINZELBEFESTIGUNG FÜR 3 KAMMER - METALLTÜREN
- ENKELE NIET-DOORGAANDE BEVESTIGING VOOR HOUT, PVC EN ALUMINIUM PROFIELEN MET 2-3 KAMERS

ART.  
FIX.510.000D.B2  
A= 33 mm  
FIX.510.00DL.B2  
A= 50 mm

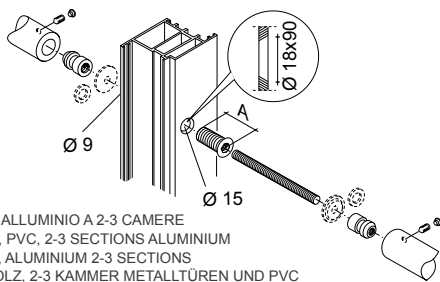

- CONTRAPPOSTO PER LEGNO, PVC, ALLUMINIO A 2-3 CAMERE
- BACK TO BACK FITTING FOR WOOD, PVC, 2-3 SECTIONS ALUMINIUM
- FIXATION DOUBLE POUR BOIS, PVC, ALUMINIUM 2-3 SECTIONS
- BEIDSEITIGE BEFESTIGUNG FÜR HOLZ, 2-3 KAMMER METALLTÜREN UND PVC
- PAARSGEWIJZE BEVESTIGING VOOR HOUT, PVC EN ALUMINIUM PROFIELEN MET 2-3 KAMERS

ART.  
FIX.610.000D.B2

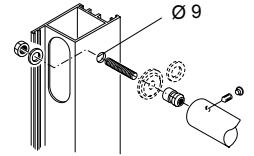

- SINGOLO NON PASSANTE PER PROFILO TUBOLARE
- SINGLE NON THROUGH FITTING FOR TUBULAR PROFILE
- FIXATION SIMPLE NON TRAVERSANT POUR PROFIL TUBULAIRE
- BEFESTIGUNG EINSEITIG UNSICHTBAR FÜR 1-KAMMER KUNSTSTOFFTÜREN
- ENKELE NIET-DOORGAANDE BEVESTIGING VOOR PROFIELEN

ART.  
FIX.710.000D.B2

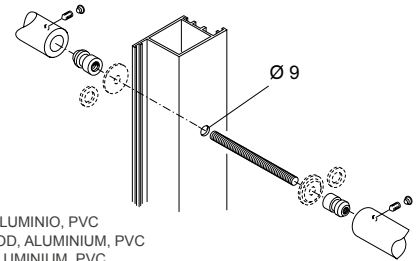

- CONTRAPPOSTO PER LEGNO, ALLUMINIO, PVC
- BACK TO BACK FITTING FOR WOOD, ALUMINIUM, PVC
- FIXATION DOUBLE POUR BOIS, ALUMINIUM, PVC
- BEIDSEITIGE BEFESTIGUNG FÜR ALLE TÜRARTEN
- PAARSGEWIJZE BEVESTIGING VOOR HOUT, ALUMINIUM EN PVC

ART.  
FIX.810.000D.B2

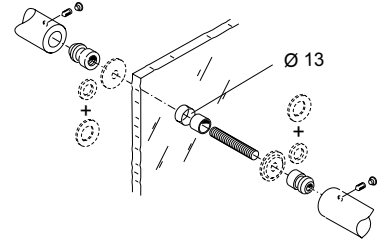

- CONTRAPPOSTO PER VETRO
- BACK TO BACK FITTING FOR GLASS
- FIXATION DOUBLE POUR VERRE
- BEIDSEITIGE BEFESTIGUNG FÜR GLASTÜREN
- PAARSGEWIJZE BEVESTIGING VOOR GLAS

I fissaggi singoli che prevedono parti in vista nelle finiture anodizzare bronzo, nero e argento non sono disponibili - Single fixings with visible parts in anodized bronze, black and silver finishes are not available  
- Les fixations simples avec parties visibles en finition bronze anodisé, noir et argent ne sont pas disponibles - Einzelbefestigungen mit sichtbaren Teilen in eloxierter Bronze, Schwarz und Silber sind nicht verfügbar - Las fijaciones sueltas con partes visibles en bronce anodizado, negro y plateado no están disponibles

Spessori per protezione vetro in dotazione - Glass protections included - Protections pour verre incluses - Schutzteilen für Glas im Lieferumfang enthalten - Glasbeschermingsrubbers meegeleverd in de verpakking

DISTANZIERI PER VETROCAMERA - SPACERS FOR DOUBLE GLAZED DOOR - ENTRETOISES POUR PORTE DOUBLE VITRAGE - ABSTANDSHALTER FÜR DOPPELGLASTÜR - AFSTANDHOUDERS VOOR DUBBEL GLAS DEUR

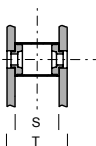

DISTANZIERI PER PORTE A DOPPIO VETRO PER MANIGLIONI SENZA SERRATURA  
DOUBLE GLAZED DOOR'S SPACERS FOR NON LOCKING PULL  
ENTRETOISES POUR PORTE DOUBLE VITRAGE POUR POIGNÉESANS SERRURE  
ABSTANDSHALTER FÜR DOPPELGLASTÜR FÜR GRIFFEN OHNE VERSCHLUSS  
AFSTANDHOUDERS VOOR DUBBEL GLAS DEUR VOOR DEURGREPEN ZONDER SLOT

S = custom  
T = custom

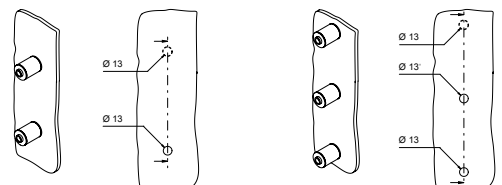



2AT.KIT.0005. xx ø 25  
2AT.KIT.0007. xx ø 30  
2AT.KIT.0009. xx ø 35

2AT.KIT.0006. xx ø 25  
2AT.KIT.0008. xx ø 30  
2AT.KIT.0010. xx ø 35

## IT

\* colori indicativi

MATERIALE	FINITURA		.XX	*
ALUMINIO	Di produzione:			
	ALLUMINIO	Bronzo	.67	
	ANODIZZATO	Nero	.68	
	SATINATO	Argento	.69	

## EN

\* indicative colors

MATERIAL	FINISH		.XX	*
ALUMINIUM	Standard:			
	ALUMINIUM	Bronze	.67	
	ANODIZED	Black	.68	
	SATIN	Silver	.69	

## FR

\* couleurs indicatives

MATERIEL	FINITION		.XX	*
ALUMINIUM	Standard:			
	ALUMINIUM	Bronze	.67	
	ANODIZE	Noir	.68	
	SATINE	Argent	.69	



## DE

\* indikative farben

MATERIAL	AUSFÜHRUNG		.XX	*
ALUMINIUM	Standard:			
	ALUMINIUM	Bronze	.67	
	ELOXIERT	Schwarz	.68	
	SATINIERT	Silber	.69	

## ES

\* colores indicativos

MATERIAL	ACABADO		.XX	*
ALUMINIO	Estándar:			
	ALUMINIO	Bronce	.67	
	ANODIZADO	Negro	.68	
	MATE	Plata	.69	

## NL

\* indicatieve colors

MATERIAAL	AFWERKINGEN		.XX	*
ALUMINIUM	Standaard:			
	ALUMINIUM	Bronz	.67	
	GEANODISEERD	Zwart	.68	
	MAT	Silver	.69	



pba S.p.A. Via Enrico Fermi, 1 I-36056 Tezze sul Brenta (Vicenza) Italia  
Tel. +39 0424 5451 Fax +39 0424 545222 info@pba.it www.pba.it

pba Deutschland GmbH Zum Schürmannsgraben 24 D-47441 Moers Deutschland  
Tel. +49 2841 99890 0 Fax +49 2841 99890 20 info@de.pba.it www.pba.it

pba USA, Inc. 68 34th Street Suite C405 Unit 20 Industry City Brooklyn NYC  
NY 11232 United States Tel. +1 212 255 4605 Fax +1 646 558 0335 office@pba-usa.us