

MADE  
IN ITALY

HANDS-FREE PULLS

PBA IS THE BRAND OF ARCHITECTURE COMPLETIONS RECOGNIZED AND FEATURED IN THE WORLD IN THE MOST IMPORTANT ARCHITECTURAL PIECES. EACH OBJECT IS IMAGINED AND MANUFACTURED IN THE BELIEF THAT A SHAPE NOT ONLY STATES A FUNCTION BUT ALSO TELLS HOW ITS CREATOR LOOKS AT THE WORLD. THE TRACED DRAWINGS, THE SHAPES PRODUCED, THE CHOSEN MATERIALS, THE ENTIRE PRODUCTION PROCESS ARE NOT ONLY THE EXPRESSION OF PURPOSES BUT ARE ALSO THE WAYS IN WHICH THE DESIGNER TAKES ON ALL RESPONSIBILITIES. THE SHAPES WE IMAGINE, DEVELOP AND PRODUCE ARE CONSIDERED SUCCESSFUL AS LONG AS THEY DO NOT ALLOW ANY SPECIFIC USER TO GLIMPSE IN THE BACKGROUND, BUT ONLY A HUMANITY THAT INHABITS, LIVES AND USES SPACES TOGETHER IN A COMFORTABLE AND SUSTAINABLE WAY.



pba S.p.A.



pba Deutschland GmbH



pba USA Inc.

THE HANDS-FREE DOOR PULL COLLECTION FROM PBA IS THE PERFECT SYNTHESIS OF FUNCTIONALITY AND SCULPTURAL ELEGANCE, PROVING, ONCE AGAIN, THAT HIGH-UTILITY PRODUCTS DON'T HAVE TO UNDERMINE THE VISUAL INTEGRITY OF A SPACE. HAND-CRAFTED OF CORROSION-RESISTANT AISI 316L STAINLESS STEEL, THE LINE INCLUDES 13 UNIQUE DESIGNS THAT LET USERS ENTER AND EXIT WITH THEIR WRISTS, FOREARMS, AND ELBOWS INSTEAD OF THEIR FINGERS AND PALMS. ADA COMPLIANT, AVAILABLE IN A CHOICE OF SATIN, POLISHED, AND POWDER COATED FINISHES TO SUIT A WIDE RANGE OF TASTES AND INTERIORS, AND MOUNTABLE TO METAL, WOOD, AND GLASS DOORS, THEY'RE THE NEW THRESHOLD TO A SMARTER, MORE HYGIENIC BUILT ENVIRONMENT. PBA COLLABORATES WITH GENSLER, SERVING AS PRODUCT DESIGN CONSULTANT, ON THIS NEW COLLECTION.

OPERABLE WITH  
WRIST, FOREARM  
OR ELBOW

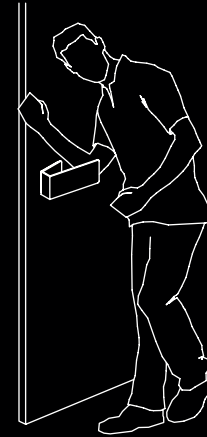

COMPLIANT WITH  
ADA STANDARDS



**ADA**  
compliant

AND STILL OPERABLE  
BY HAND

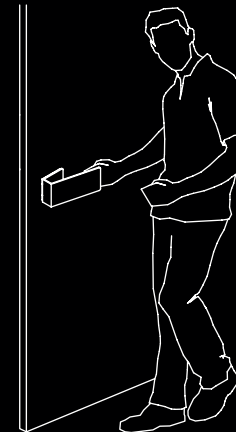

# THE COLLECTION

Red List Free

Declare.

# Design 1

HANDS-FREE PULLS



STAINLESS STEEL SATIN AS PICTURED

## Design 1

ITEM	A	B	C	D	F
GHF.D01.0001. xx	101,60 mm 4"	203,20 mm 8"	101,60 mm 4"	101,60 mm 4"	50,80 mm 2"

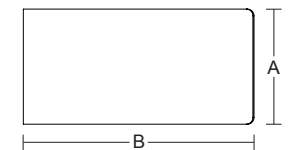
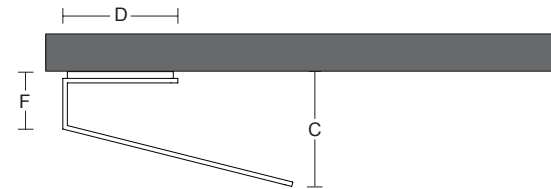

### FINISHES .XX

STAINLESS STEEL

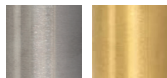

Satin .44  
Satin Gold .80

STAINLESS STEEL POWDER COATED



White .31  
Champagne .38  
Bronze .39  
Grey .32  
Black .40

Single fixing kit for wood door included  
Back to back fixings available on request  
Fixing kit for glass and metal door available on request

Push plate available on page 31

# Design 1

HANDS-FREE PULLS



OPERABLE WITH  
WRIST, FOREARM  
OR ELBOW

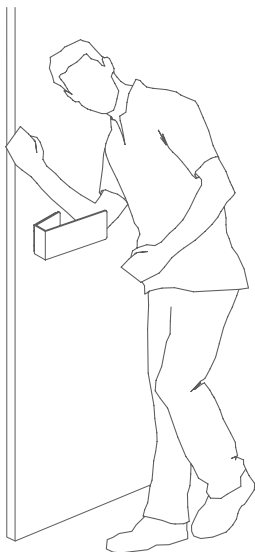

COMPLIANT WITH  
ADA STANDARDS

**ADA**  
compliant

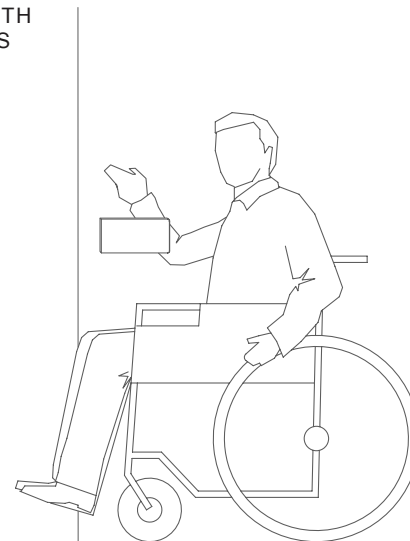

AND STILL OPERABLE  
BY HAND

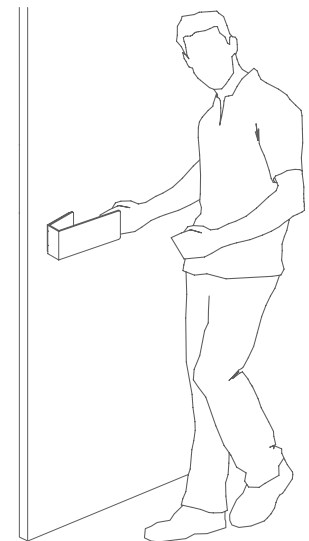

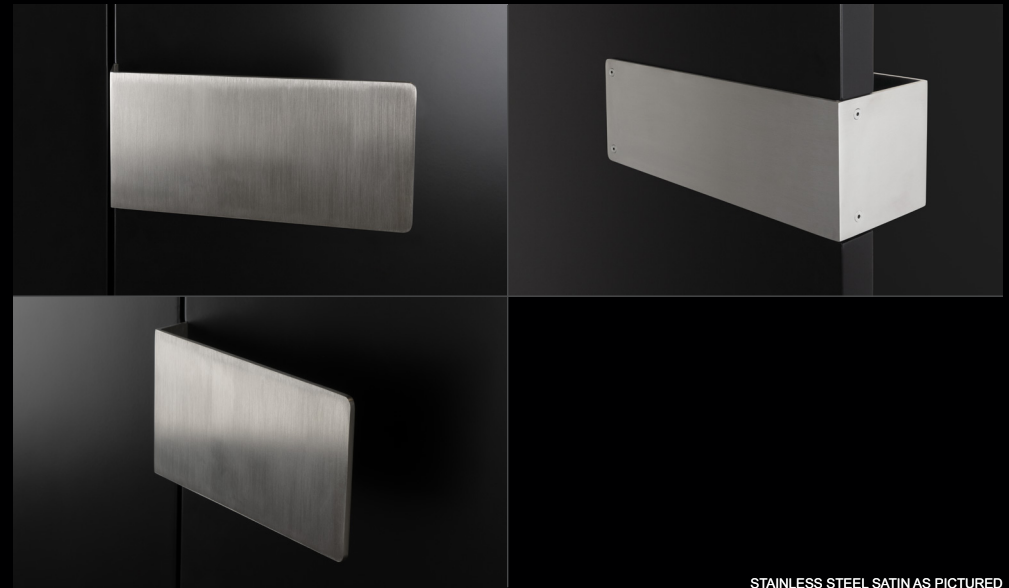

STAINLESS STEEL SATIN AS PICTURED

## Design 2.1

ITEM	A	B	C	D	F	G
<b>GHF.D02.0001. xx</b>	101,60 mm 4"	304,80 mm 12"	140,60 mm 5 17/32"	203,21 mm 8"	64,40 mm 2 17/32"	Max 101,60 mm 4"

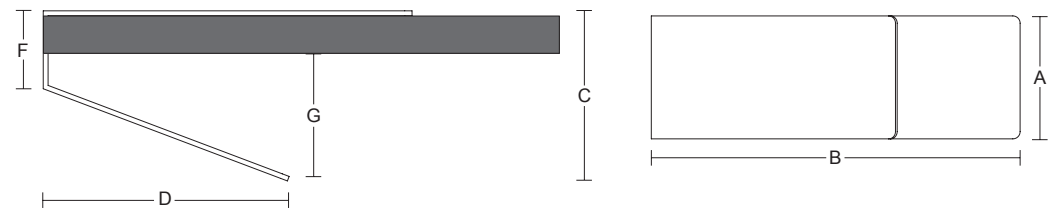

### FINISHES .XX

#### STAINLESS STEEL

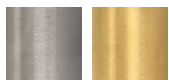

Satin .44  
 Satin Gold .80

#### STAINLESS STEEL POWDER COATED



White .31  
 Champagne .38  
 Bronze .39  
 Grey .32  
 Black .40

Fixing kit for wood door included  
 Fixing: Satin for .44 Satin finish - Bright for .43 Bright finish - Black for .39 Bronze, .32 Grey, .40 Black finish - Satin for .31 White, .38 Champagne finish

# Design 2.1

HANDS-FREE PULLS



OPERABLE WITH  
WRIST, FOREARM  
OR ELBOW

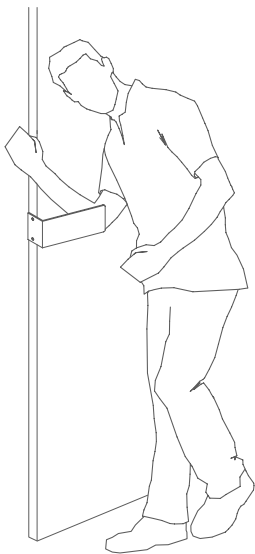

COMPLIANT WITH  
ADA STANDARDS

**ADA**  
compliant

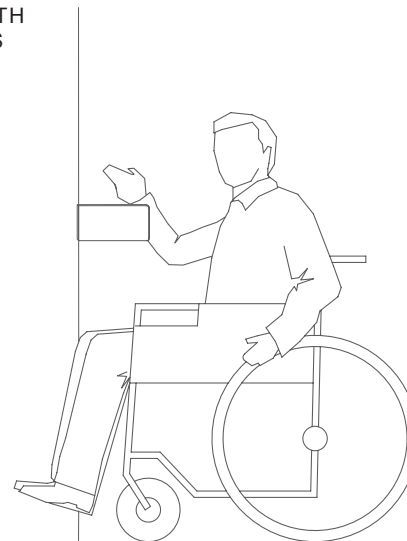

AND STILL OPERABLE  
BY HAND

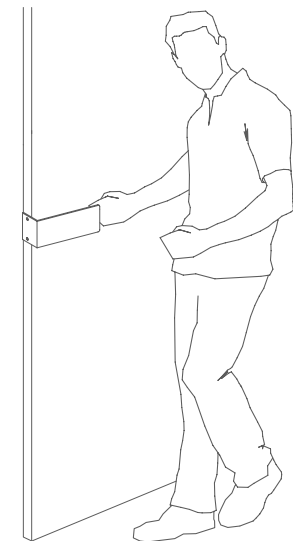



Red List Free

Declare.

# Design 2.2

HANDS-FREE PULLS

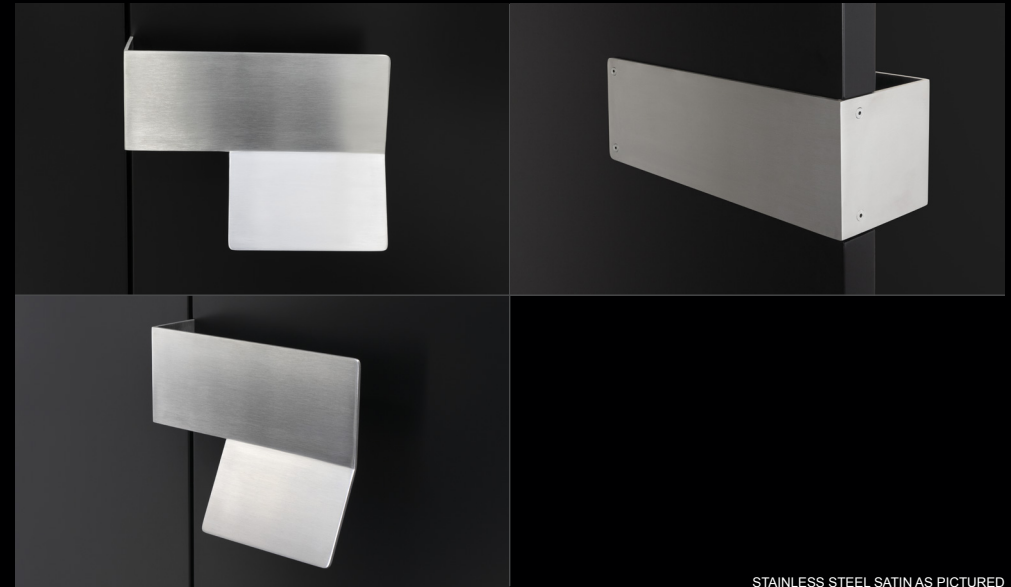

STAINLESS STEEL SATIN AS PICTURED

## Design 2.2

ITEM	A	B	C	D	E	F	G
GHF.D02.0002. xx	190,50 mm 7 1/2"	304,80 mm 12"	140,60 mm 5 17/32"	254 mm 10"	101,60 mm 4"	102,50 mm 4 1/32"	Max 101,60 mm 4"

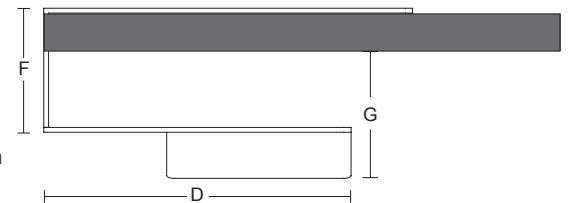

RIGHT HAND

### FINISHES .XX

STAINLESS STEEL

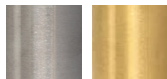

Satin .44  
Satin Gold .80

STAINLESS STEEL POWDER COATED

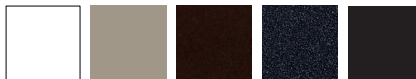

White .31  
Champagne .38  
Bronze .39  
Grey .32  
Black .40

Fixing kit for wood door included

Fixing: Satin for .44 Satin finish - Bright for .43 Bright finish - Black for .39 Bronze, .32 Grey, .40 Black finish - Satin for .31 White, .38 Champagne finish

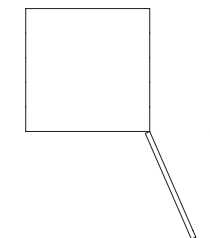
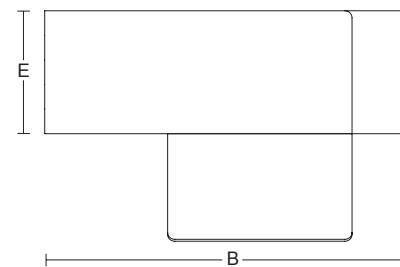

# Design 2.2

HANDS-FREE PULLS



OPERABLE WITH  
WRIST, FOREARM  
OR ELBOW

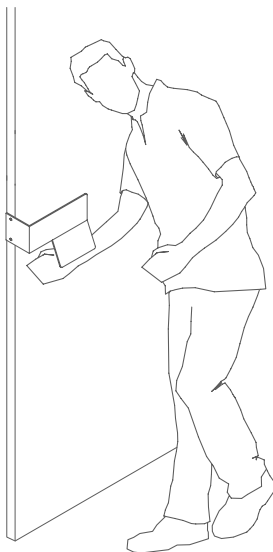

COMPLIANT WITH  
ADA STANDARDS

**ADA**  
compliant

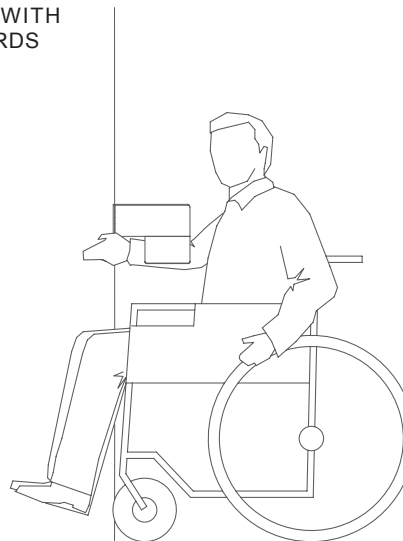

AND STILL OPERABLE  
BY HAND

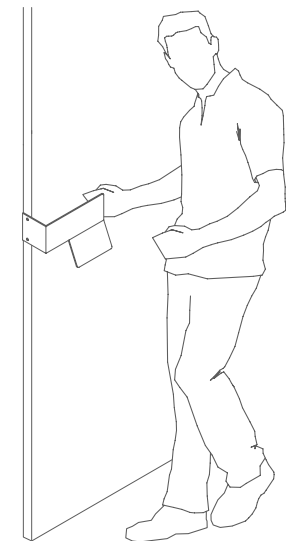

Red List Free

Declare.

# Design 2.3

HANDS-FREE PULLS



STAINLESS STEEL SATIN AS PICTURED

## Design 2.3

ITEM	A	B	C	D	E	F	G
GHF.D02.0003. xx	228,60 mm 9"	304,80 mm 12"	140,60 mm 5 17/32"	254 mm 10"	101,60 mm 4"	102,50 mm 4 1/32"	Max 101,60 mm 4"

### FINISHES .XX

STAINLESS STEEL

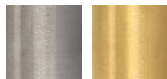

Satin .44  
Satin Gold .80

STAINLESS STEEL POWDER COATED

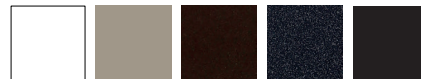

White .31  
Champagne .38  
Bronze .39  
Grey .32  
Black .40

Fixing kit for wood door included  
Fixing: Satin for .44 Satin finish - Bright for .43 Bright finish - Black for .39 Bronze, .32 Grey, .40 Black finish - Satin for .31 White, .38 Champagne finish

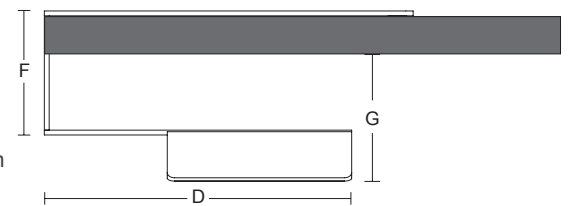

RIGHT HAND

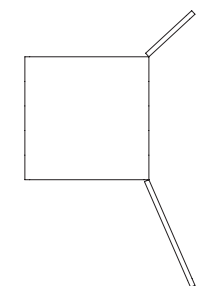
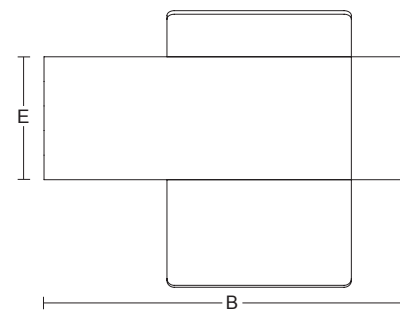

# Design 2.3

HANDS-FREE PULLS



OPERABLE WITH  
WRIST, FOREARM  
OR ELBOW

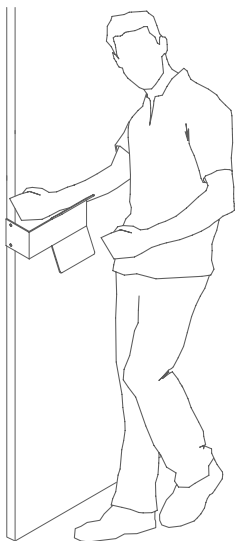

COMPLIANT WITH  
ADA STANDARDS

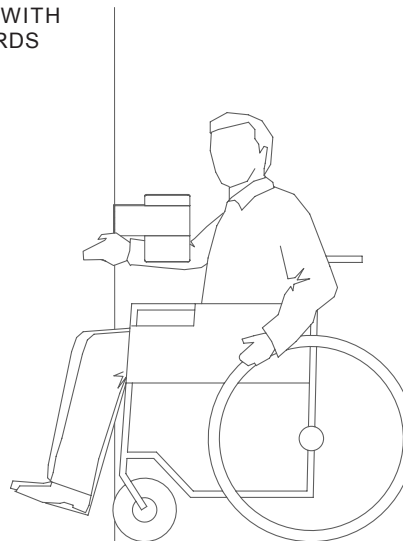

**ADA**  
compliant

AND STILL OPERABLE  
BY HAND



Red List Free

Declare.

# Design 3

HANDS-FREE PULLS

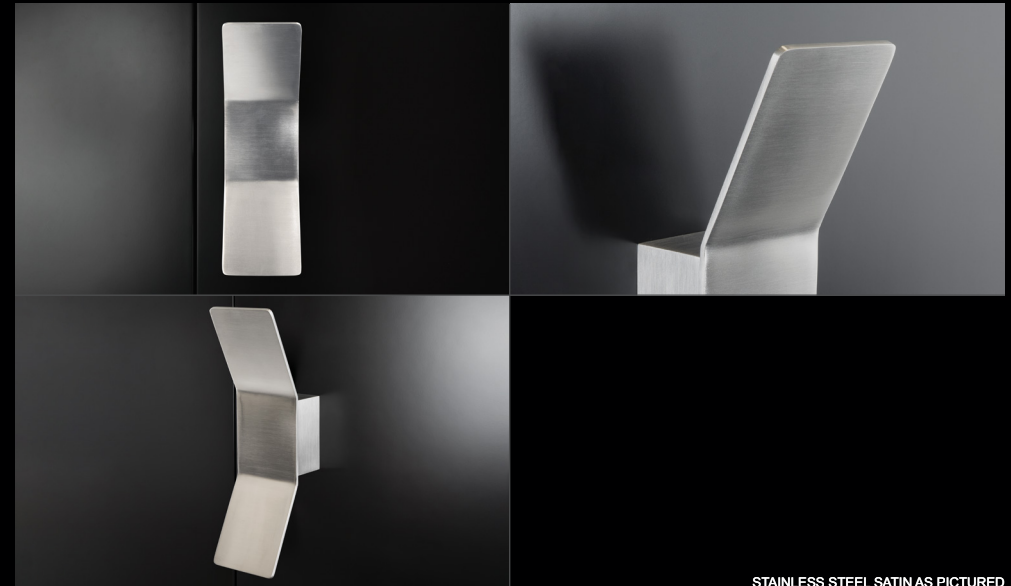

STAINLESS STEEL SATIN AS PICTURED

## Design 3

ITEM	A	B	C	E	F
GHF.D03.0001. xx	304,80 mm 12"	88,90 mm 3 1/2"	101,60 mm 4"	101,60 mm 4"	54,80 mm 2 5/32"

### FINISHES .XX

STAINLESS STEEL



Satin .44  
Bright .43  
Satin Gold .80

STAINLESS STEEL POWDER COATED



White .31  
Champagne .38  
Bronze .39  
Grey .32  
Black .40

Single fixing kit for wood door included  
Back to back fixings available on request  
Fixing kit for glass and metal door available on request

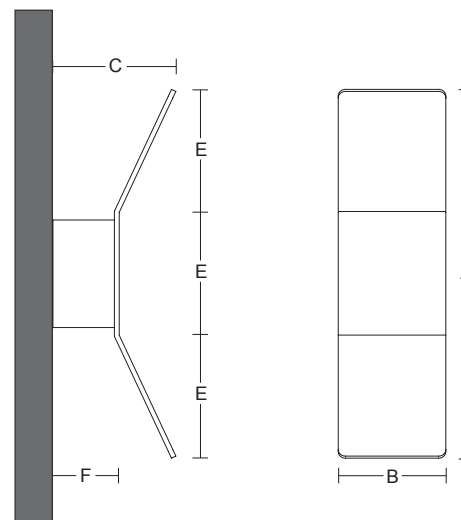

Push plate available on page 31

# Design 3

HANDS-FREE PULLS



OPERABLE WITH  
WRIST, FOREARM  
OR ELBOW



COMPLIANT WITH  
ADA STANDARDS

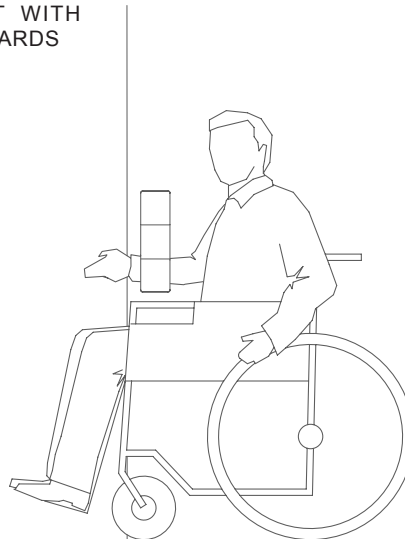

**ADA**  
compliant

AND STILL OPERABLE  
BY HAND



Red List Free

Declare.

# Design 4.1

HANDS-FREE PULLS

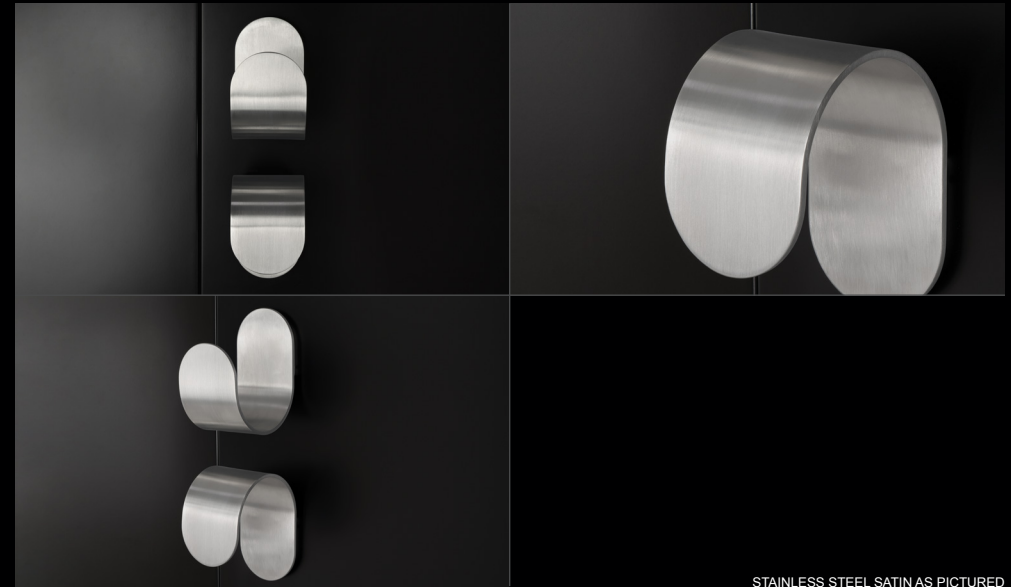
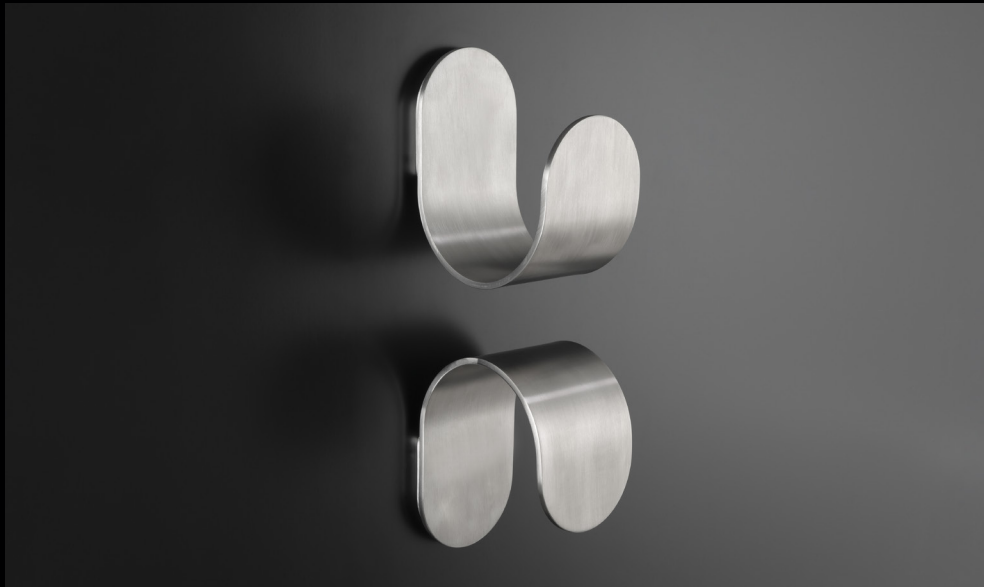

STAINLESS STEEL SATIN AS PICTURED

## Design 4.1

ITEM	A	B	C	E	F
GHF.D04.0001. xx	127 mm 5"	76,20 mm 3"	101,60 mm 4"	93,60 mm 3 11/16"	10 mm 25/64"

### FINISHES .XX

#### STAINLESS STEEL



Satin .44  
Bright .43  
Satin Gold .80

#### STAINLESS STEEL POWDER COATED

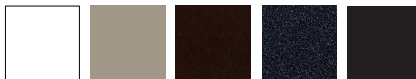

White .31  
Champagne .38  
Bronze .39  
Grey .32  
Black .40

Single fixing kit for wood door included  
Back to back fixings available on request  
Fixing kit for glass and metal door available on request

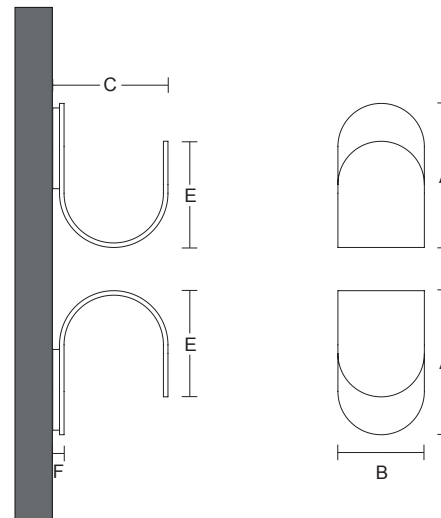

Push plate available on page 31

# Design 4.1

HANDS-FREE PULLS



OPERABLE WITH  
WRIST, FOREARM  
OR ELBOW



COMPLIANT WITH  
ADA STANDARDS

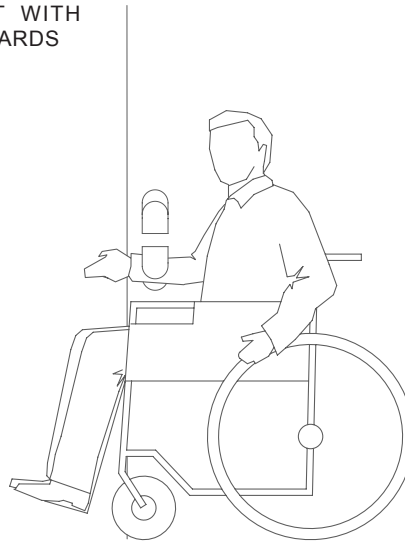

**ADA**  
compliant

AND STILL OPERABLE  
BY HAND





Red List Free

Declare.

# Design 4.2

HANDS-FREE PULLS

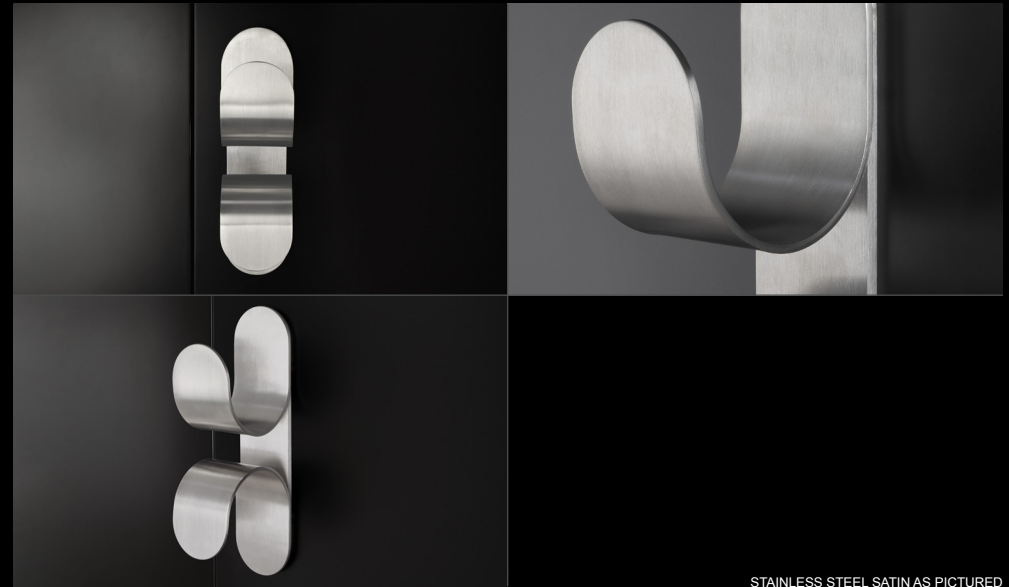
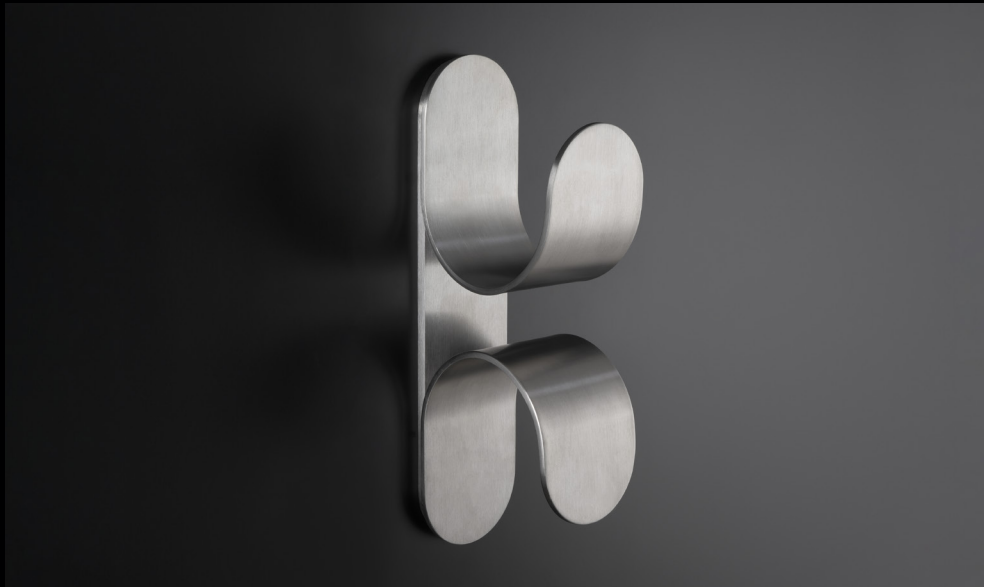

STAINLESS STEEL SATIN AS PICTURED

## Design 4.2

ITEM	A	B	C	D	E	F
GHF.D04.0002. xx	292,10 mm 11 1/2"	76,20 mm 3"	101,60 mm 4"	68,20 mm 2 11/16"	93,60 mm 3 11/16"	10 mm 25/64"

### FINISHES .XX

#### STAINLESS STEEL



Satin .44  
Bright .43  
Satin Gold .80

#### STAINLESS STEEL POWDER COATED

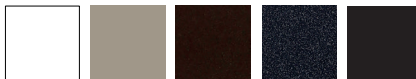

White .31  
Champagne .38  
Bronze .39  
Grey .32  
Black .40

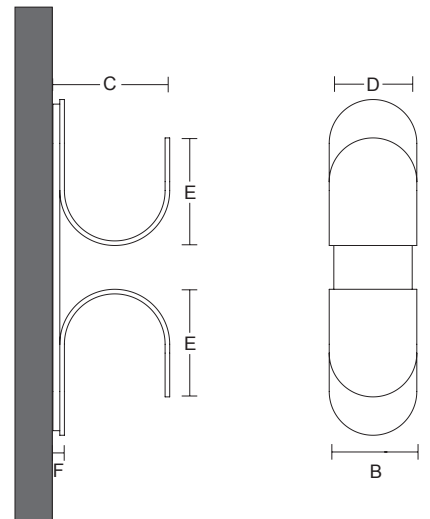

Single fixing kit for wood door included  
Back to back fixings available on request  
Fixing kit for glass and metal door available on request

Push plate available on page 31

# Design 4.2

HANDS-FREE PULLS



OPERABLE WITH  
WRIST, FOREARM  
OR ELBOW

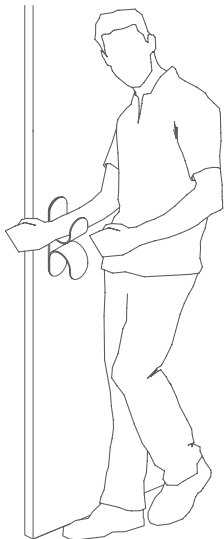

COMPLIANT WITH  
ADA STANDARDS

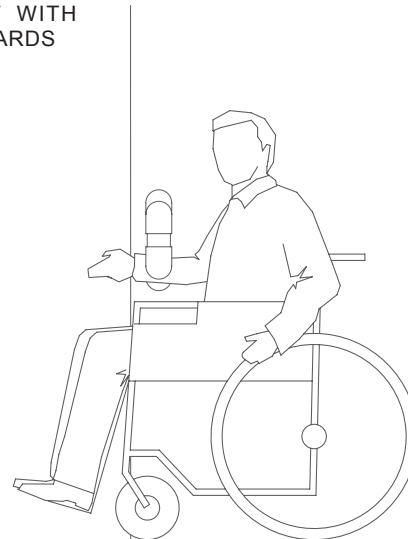

**ADA**  
compliant

AND STILL OPERABLE  
BY HAND



Red List Free

Declare.

# Design 5.1

HANDS-FREE PULLS



STAINLESS STEEL SATIN AS PICTURED

## Design 5.1

ITEM	A	B	C	F
GHF.D05.0001. xx	196,85 mm 7 3/4"	152,40 mm 6"	101,60 mm 4"	10 mm 25/64"

### FINISHES .XX

#### STAINLESS STEEL



Satin .44  
Bright .43  
Satin Gold .80

#### STAINLESS STEEL POWDER COATED

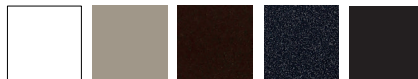

White .31  
Champagne .38  
Bronze .39  
Grey .32  
Black .40

Single fixing kit for wood door included  
Back to back fixings available on request  
Fixing kit for glass and metal door available on request

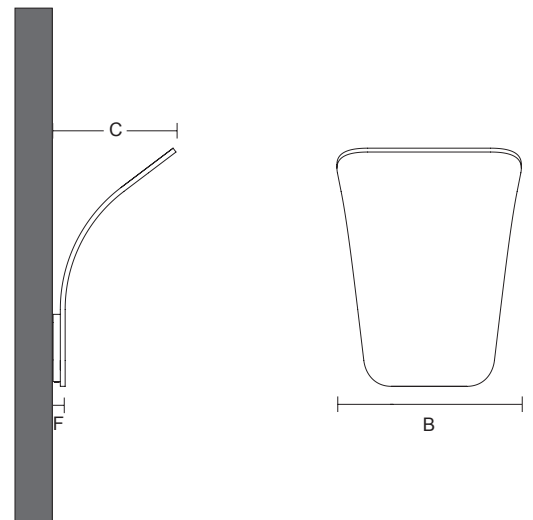

Push plate available on page 31

# Design 5.1

HANDS-FREE PULLS



OPERABLE WITH  
WRIST, FOREARM  
OR ELBOW



COMPLIANT WITH  
ADA STANDARDS

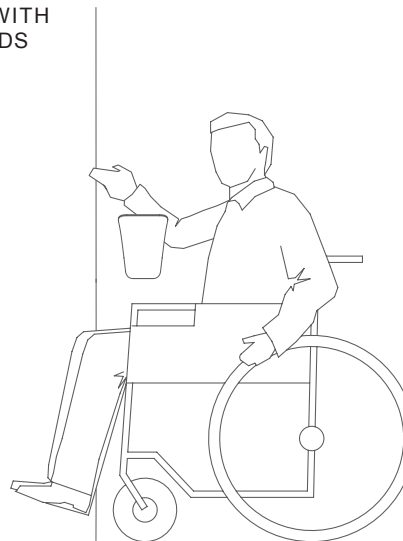

**ADA**  
compliant

AND STILL OPERABLE  
BY HAND



Red List Free

Declare.

# Design 5.2

HANDS-FREE PULLS

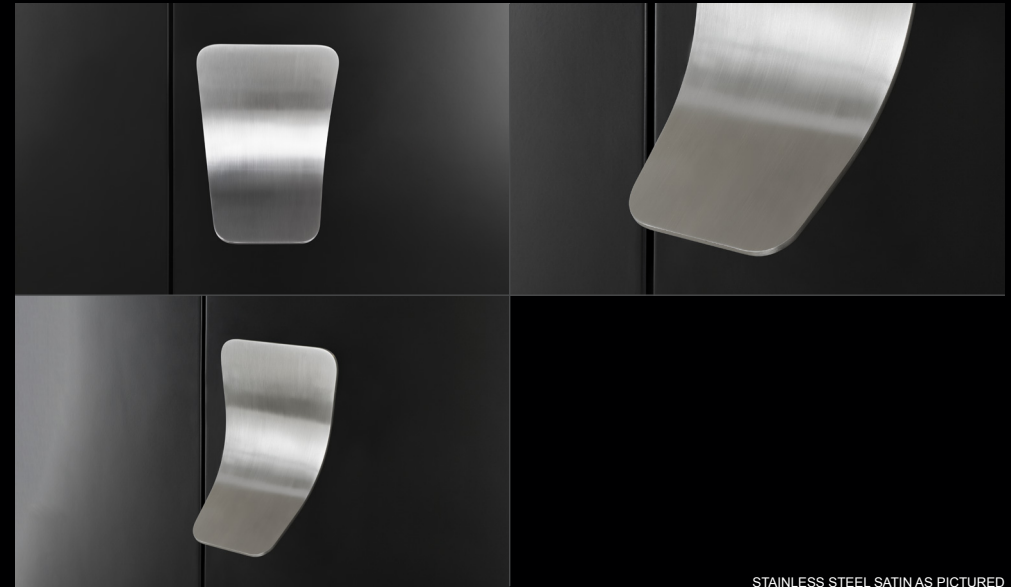
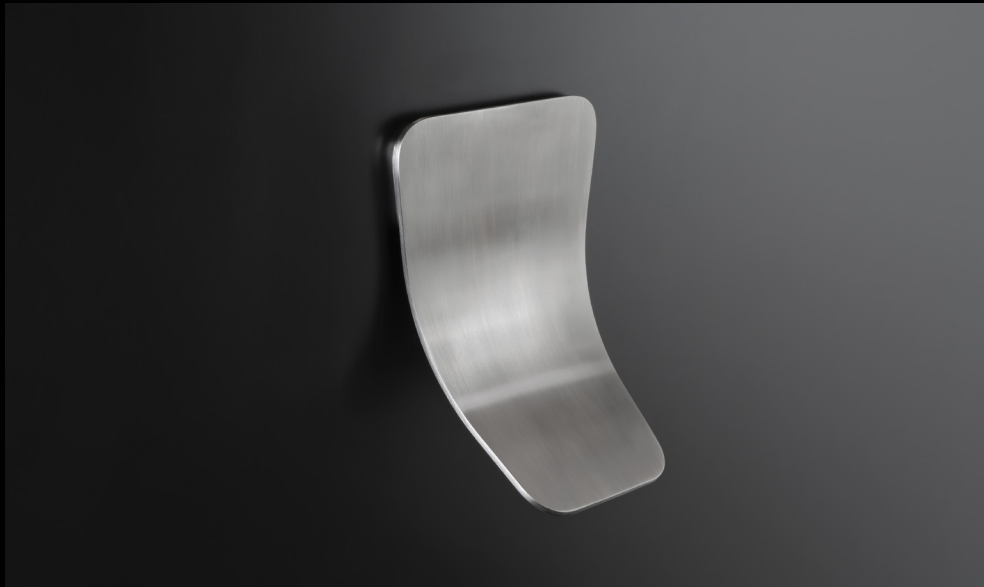

STAINLESS STEEL SATIN AS PICTURED

## Design 5.2

ITEM	A	B	C	F
<b>GHF.D05.0002. xx</b>	196,85 mm 7 3/4"	152,40 mm 6"	101,60 mm 4"	10 mm 25/64"

### FINISHES .XX

#### STAINLESS STEEL



Satin .44  
Bright .43  
Satin Gold .80

#### STAINLESS STEEL POWDER COATED

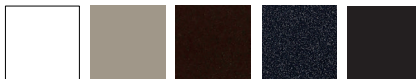

White .31  
Champagne .38  
Bronze .39  
Grey .32  
Black .40

Single fixing kit for wood door included  
Back to back fixings available on request  
Fixing kit for glass and metal door available on request

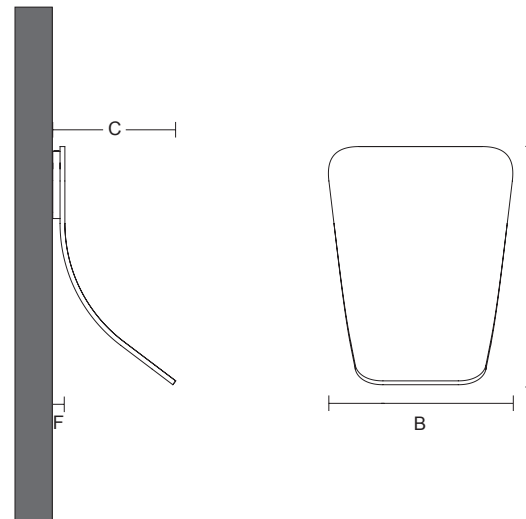

Push plate available on page 31

# Design 5.2

HANDS-FREE PULLS



OPERABLE WITH  
WRIST, FOREARM  
OR ELBOW



COMPLIANT WITH  
ADA STANDARDS

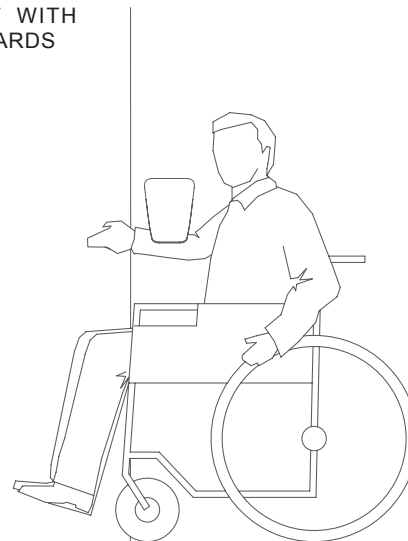

**ADA**  
compliant

AND STILL OPERABLE  
BY HAND



Red List Free

Declare.

# Design 6.1

HANDS-FREE PULLS



STAINLESS STEEL SATIN AS PICTURED

## Design 6.1

ITEM	A	B	C	D	F
GHF.D06.0001. xx	393,70 mm 15 1/2"	152,40 mm 6"	101,60 mm 4"	107,95 mm 4 1/4"	10 mm 25/64"

### FINISHES .XX

#### STAINLESS STEEL



Satin .44  
Bright .43  
Satin Gold .80

#### STAINLESS STEEL POWDER COATED

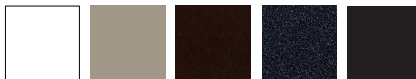

White .31  
Champagne .38  
Bronze .39  
Grey .32  
Black .40

Single fixing kit for wood door included  
Back to back fixings available on request  
Fixing kit for glass and metal door available on request

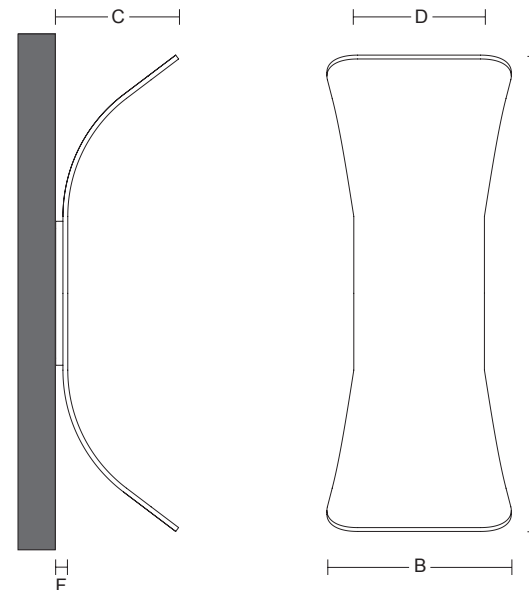

Push plate available on page 31

# Design 6.1

HANDS-FREE PULLS



OPERABLE WITH  
WRIST, FOREARM  
OR ELBOW

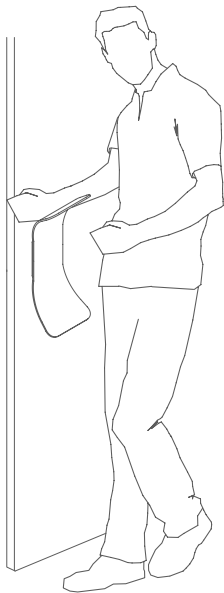

COMPLIANT WITH  
ADA  
STANDARDS

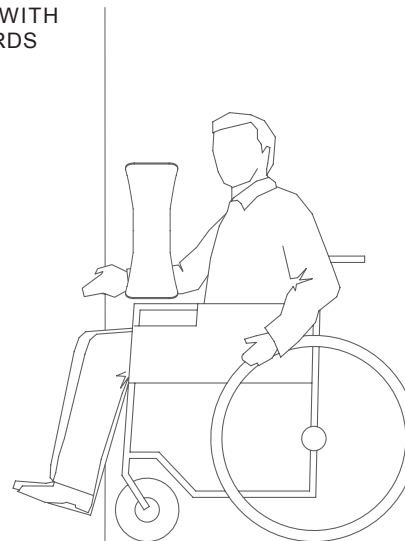

**ADA**  
compliant

AND STILL OPERABLE  
BY HAND





Red List Free

Declare.

# Design 6.2

HANDS-FREE PULLS



STAINLESS STEEL SATIN AS PICTURED

## Design 6.2

ITEM	A	B	C	E	F
<b>GHF.D06.0002. xx</b>	393,70 mm 15 1/2"	152,40 mm 6"	101,60 mm 4"	127 mm 5"	10 mm 25/64"

### FINISHES .XX

#### STAINLESS STEEL



Satin .44  
Bright .43  
Satin Gold .80

#### STAINLESS STEEL POWDER COATED

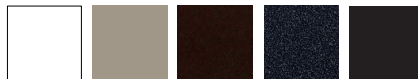

White .31  
Champagne .38  
Bronze .39  
Grey .32  
Black .40

Single fixing kit for wood door included  
Back to back fixings available on request  
Fixing kit for glass and metal door available on request

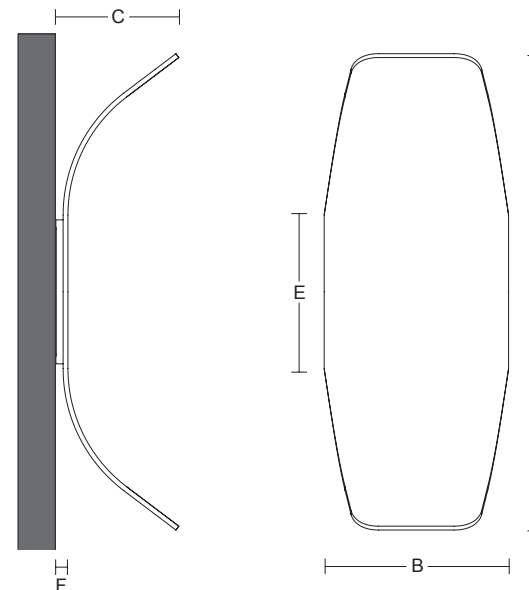

Push plate available on page 31

# Design 6.2

HANDS-FREE PULLS



OPERABLE WITH  
WRIST, FOREARM  
OR ELBOW

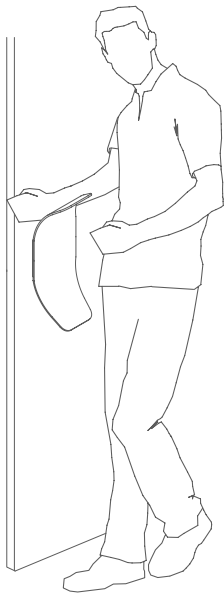

COMPLIANT WITH  
ADA STANDARDS

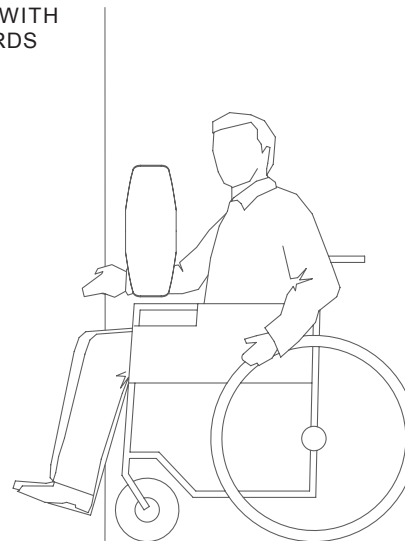

**ADA**  
compliant

AND STILL OPERABLE  
BY HAND



Red List Free

Declare.

# Design 6.3

HANDS-FREE PULLS



STAINLESS STEEL SATIN AS PICTURED

## Design 6.3

ITEM	A	B	C	F
GHF.D06.0003. xx	393,70 mm 15 1/2"	152,40 mm 6"	101,60 mm 4"	10 mm 25/64"

### FINISHES .XX

#### STAINLESS STEEL



Satin .44  
Bright .43  
Satin Gold .80

#### STAINLESS STEEL POWDER COATED

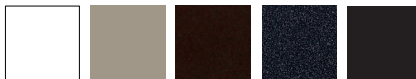

White .31  
Champagne .38  
Bronze .39  
Grey .32  
Black .40

Single fixing kit for wood door included  
Back to back fixings available on request  
Fixing kit for glass and metal door available on request

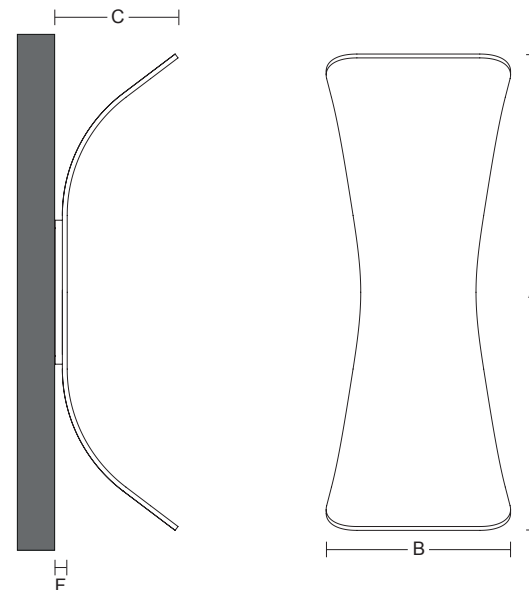

Push plate available on page 31

# Design 6.3

HANDS-FREE PULLS



OPERABLE WITH  
WRIST, FOREARM  
OR ELBOW

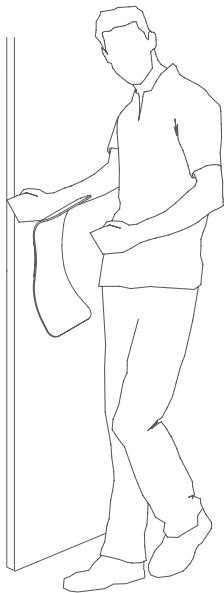

COMPLIANT WITH  
ADA  
STANDARDS

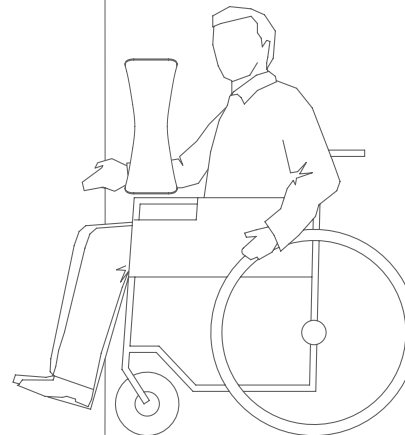

**ADA**  
compliant

AND STILL OPERABLE  
BY HAND



Red List Free

Declare.

# Design 6.4

HANDS-FREE PULLS



STAINLESS STEEL SATIN AS PICTURED

## Design 6.4

ITEM	A	B	C	D	E	F
GHF.D06.0004. xx	393,70 mm 15 1/2"	203,20 mm 8"	101,60 mm 4"	107,95 mm 4 1/4"	127 mm 5"	10 mm 25/64"

### FINISHES .XX

#### STAINLESS STEEL



Satin .44  
Bright .43  
Satin Gold .80

#### STAINLESS STEEL POWDER COATED

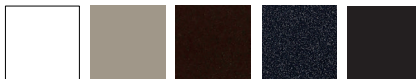

White .31  
Champagne .38  
Bronze .39  
Grey .32  
Black .40

Single fixing kit for wood door included  
Back to back fixings available on request  
Fixing kit for glass and metal door available on request

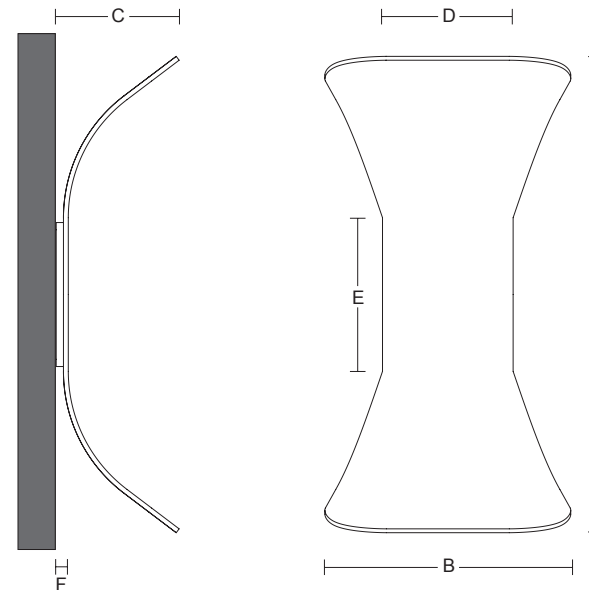

Push plate available on page 31

# Design 6.4

HANDS-FREE PULLS



OPERABLE WITH  
WRIST, FOREARM  
OR ELBOW



COMPLIANT WITH  
ADA  
STANDARDS

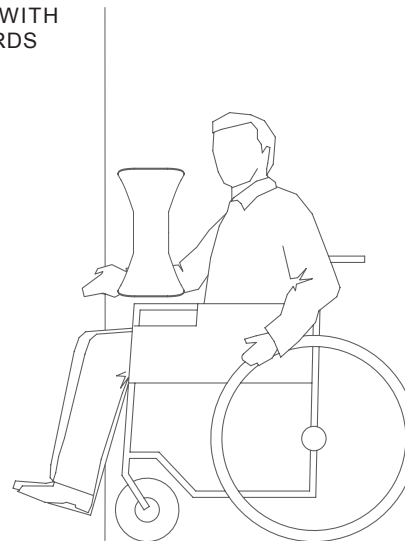

**ADA**  
compliant

AND STILL OPERABLE  
BY HAND



Red List Free

Declare.

# Push Plate

HANDS-FREE PULLS

ITEM	A	B
2MM.PLA.9999. xx	Custom	Custom

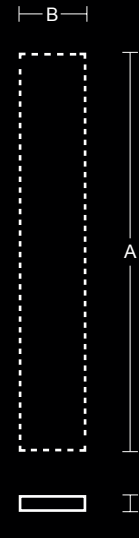

S MIN 5/64" (2mm)  
MAX 5/16" (8mm)



## FINISHES .XX

STAINLESS STEEL



Satin .44  
Bright .43  
Satin Gold .80

STAINLESS STEEL POWDER COATED



White .31  
Champagne .38  
Bronze .39  
Grey .32  
Black .40

Available with holes for fixing with screws or without holes for gluing.  
Fixings not included.

Fixing: Satin for .44 Satin finish - Bright for .43 Bright finish - Black for .39 Bronze, .32 Grey, .40 Black finish - Satin for .31 White, .38 Champagne finish

OPERABLE WITH  
WRIST, FOREARM  
OR ELBOW



COMPLIANT WITH  
ADA STANDARDS

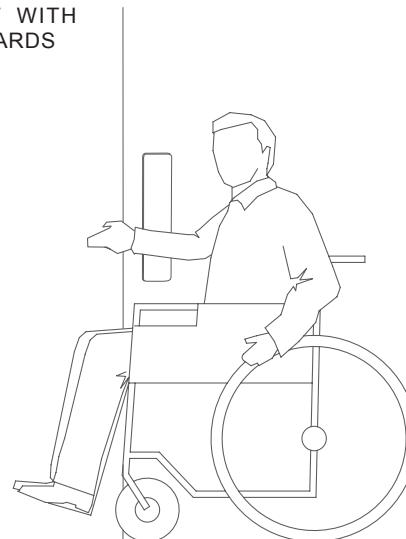

ADA  
compliant

AND STILL OPERABLE  
BY HAND

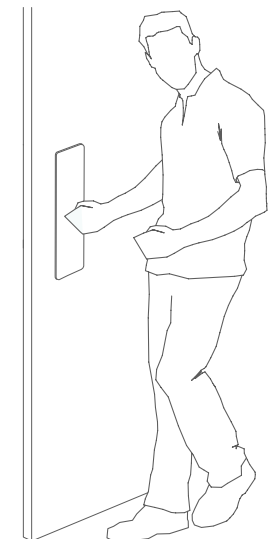

# Finishes

## STAINLESS STEEL



Satin  
.44



Bright  
.43

## STAINLESS STEEL SATIN GOLD



Satin Gold  
.80

## STAINLESS STEEL POWDER COATED



White  
.31



Champagne  
.38



Bronze  
.39



Grey  
.32



Black  
.40

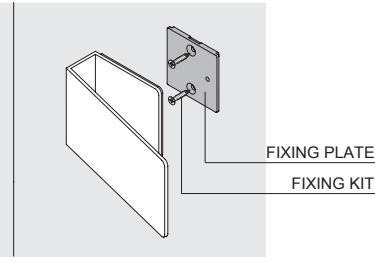
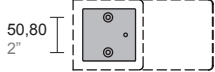
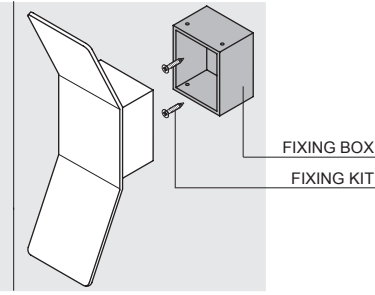
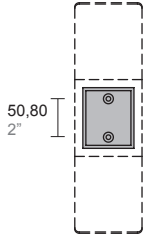
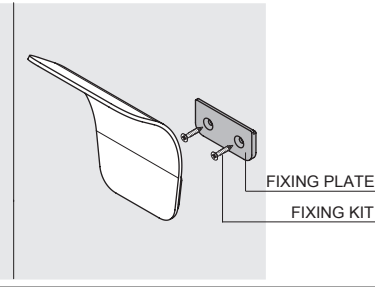
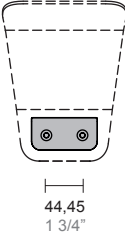
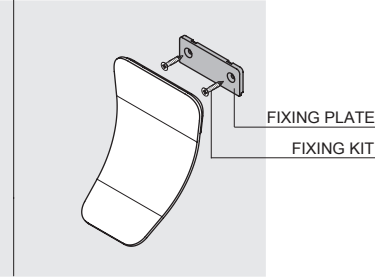
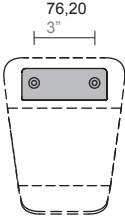

# TECHNICAL INFORMATION

ITEM	FIXING PLATE INCLUDED	SINGLE SIDE FIXING KIT FOR WOOD DOOR	FIXING PLATE DETAILS	DOOR THICKNESS
<p><b>Design 1</b> GHF.D01.0001. xx</p>	 <p>FIXING PLATE FIXING KIT</p>	<p>GHF.FIX.0001. 00</p>		<p>MIN 1 1/2" (38 mm)</p>
<p><b>Design 3</b> GHF.D03.0001. xx</p>	 <p>FIXING BOX FIXING KIT</p>	<p>GHF.FIX.0001. 00</p>		<p>MIN 1 1/2" (38 mm)</p>
<p><b>Design 5.1</b> GHF.D05.0001. xx</p>	 <p>FIXING PLATE FIXING KIT</p>	<p>GHF.FIX.0001. 00</p>		<p>MIN 1 1/2" (38 mm)</p>
<p><b>Design 5.2</b> GHF.D05.0002. xx</p>	 <p>FIXING PLATE FIXING KIT</p>	<p>GHF.FIX.0001. 00</p>		<p>MIN 1 1/2" (38 mm)</p>

**NOTE:**  
 Back to back fixings available on request  
 Fixing kit for glass and metal door available on request  
 Push plate for single through fixing

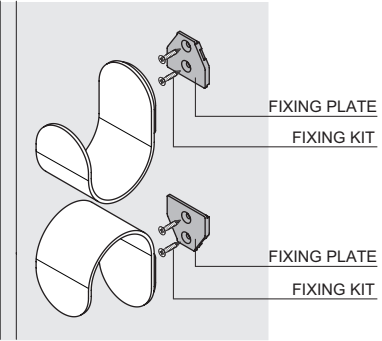
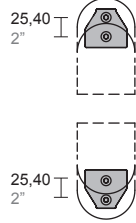
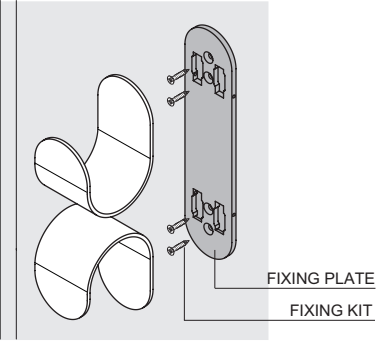
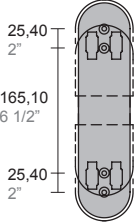
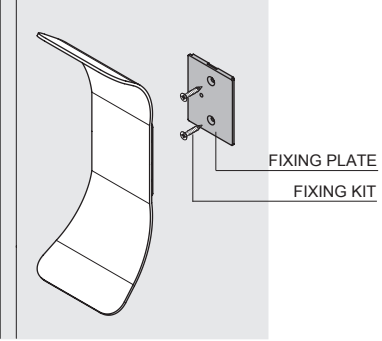
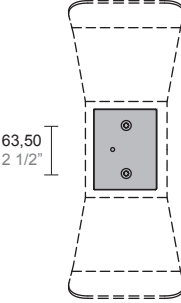
ITEM	FIXING PLATE INCLUDED	SINGLE SIDE FIXING KIT FOR WOOD DOOR	FIXING PLATE DETAILS	DOOR THICKNESS
<p><b>Design 4.1</b> GHF.D04.0001. xx</p>		<p><b>GHF.FIX.0001. 00 *</b></p> <p>* 2 FIXING KITS NEEDED</p>		<p>MIN 1 1/2" (38 mm)</p>
<p><b>Design 4.2</b> GHF.D04.0002. xx</p>		<p><b>GHF.FIX.0001. 00 *</b></p> <p>* 2 FIXING KITS NEEDED</p>		<p>MIN 1 1/2" (38 mm)</p>
<p><b>Design 6.1</b> GHF.D06.0001. xx</p>		<p><b>GHF.FIX.0001. 00</b></p>		<p>MIN 1 1/2" (38 mm)</p>

**NOTE:**  
 Back to back fixings available on request  
 Fixing kit for glass and metal door available on request  
 Push plate for single through fixing

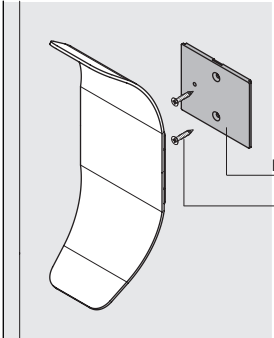
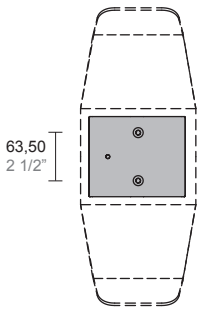
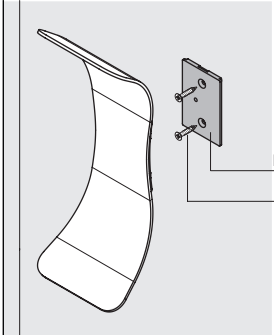
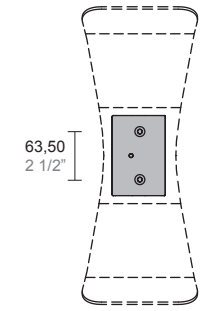
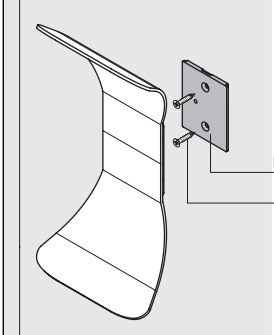
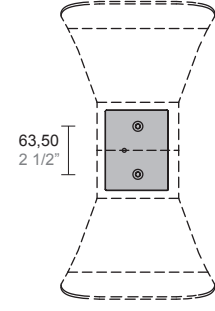
ITEM	FIXING PLATE INCLUDED	SINGLE SIDE FIXING KIT FOR WOOD DOOR	FIXING PLATE DETAILS	DOOR THICKNESS
<p><b>Design 6.2</b> GHF.D06.0002. xx</p>	 <p>FIXING PLATE FIXING KIT</p>	<p><b>GHF.FIX.0001. 00</b></p>	 <p>63,50 2 1/2"</p>	<p>MIN 1 1/2" (38 mm)</p>
<p><b>Design 6.3</b> GHF.D06.0003. xx</p>	 <p>FIXING PLATE FIXING KIT</p>	<p><b>GHF.FIX.0001. 00</b></p>	 <p>63,50 2 1/2"</p>	<p>MIN 1 1/2" (38 mm)</p>
<p><b>Design 6.4</b> GHF.D06.0004. xx</p>	 <p>FIXING PLATE FIXING KIT</p>	<p><b>GHF.FIX.0001. 00</b></p>	 <p>63,50 2 1/2"</p>	<p>MIN 1 1/2" (38 mm)</p>

**NOTE:**  
 Back to back fixings available on request  
 Fixing kit for glass and metal door available on request  
 Push plate for single through fixing

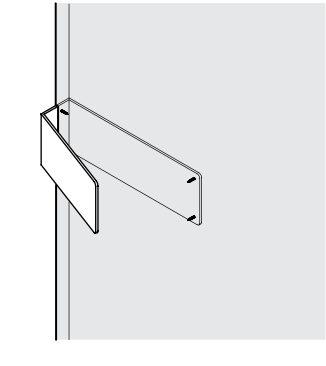
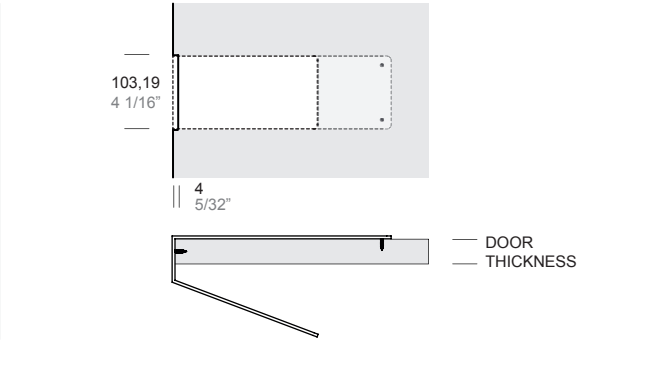
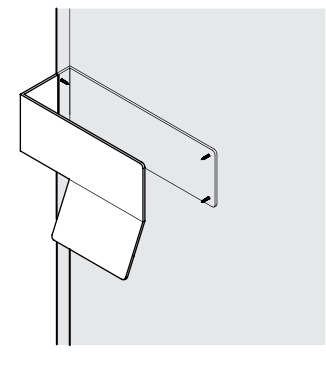
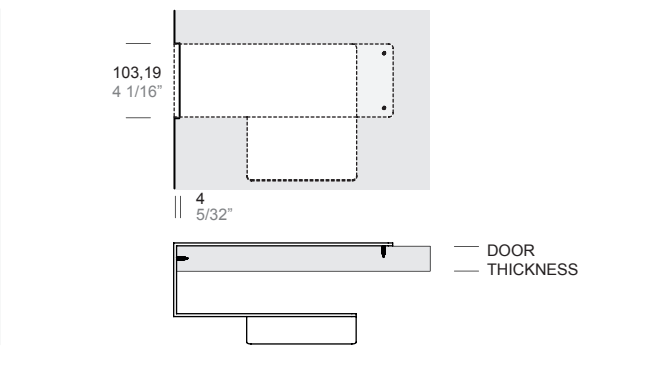
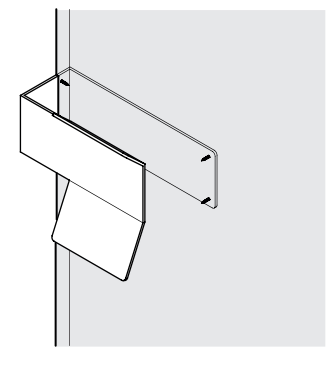
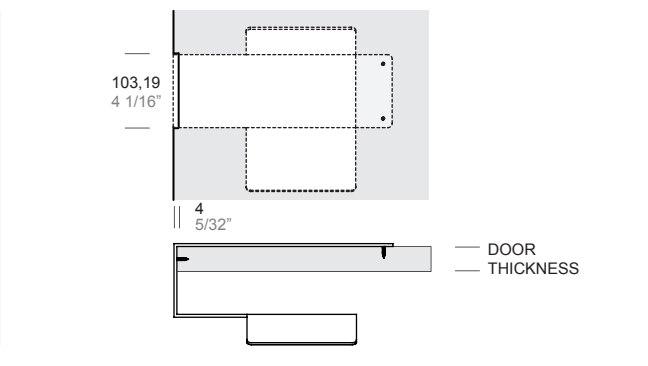
ITEM	WOOD DOOR PREPARATION DETAIL		FIXING KIT FOR WOOD DOOR	DOOR THICKNESS
<p><b>Design 2.1</b> GHF.D02.0001. xx</p>			<p><b>GHF.FIX.0002. xx</b></p>	<p>MIN 1 3/8" (35 mm)</p> <p>MAX 1 3/4" (44,45 mm)</p> <p>WOOD DOOR ONLY</p>
<p><b>Design 2.2</b> GHF.D02.0002. xx</p>			<p><b>GHF.FIX.0002. xx</b></p>	<p>MIN 1 3/8" (35 mm)</p> <p>MAX 1 3/4" (44,45 mm)</p> <p>WOOD DOOR ONLY</p>
<p><b>Design 2.3</b> GHF.D02.0003. xx</p>			<p><b>GHF.FIX.0002. xx</b></p>	<p>MIN 1 3/8" (35 mm)</p> <p>MAX 1 3/4" (44,45 mm)</p> <p>WOOD DOOR ONLY</p>
<p><b>Push Plate</b> 2MM.PLA.9999. xx</p>	<p>Custom</p>	<p>Custom</p>	<p><b>GHF.FIX.0002. xx</b></p>	

**Chemical composition of AISI stainless steel grades**

<i>Material - Stainless steel</i>	<i>C %</i>	<i>Cr %</i>	<i>Ni %</i>	<i>Mo %</i>
AISI 430 (1.4016)	0,12 max	14.0-18.0	/	/
AISI 304 (1.4301)	0,08 max	18.0-20.0	8.0-10.5	/
AISI 316 (1.4401)	0,08 max	16.0-18.0	10.0-14.0	2.00-3.00
<b>AISI 316L (1.4404)*</b>	<b>0,03 max</b>	<b>16.0-18.0</b>	<b>10.0-14.0</b>	<b>2.00-3.00</b>

\*Standard pba

**Estimated pit corrosion time – time to penetrate 1 mm (years) by steel type**

<i>Location - Stainless Steel</i>	<i>Marine</i>	<i>Semi-industrial</i>	<i>Rural</i>
Stainless steel AISI 430 (1.4016)	N/A	85	250
Stainless steel AISI 304 (1.4301)	145	135	770
<b>Stainless steel AISI 316 (1.4401)</b>	<b>260</b>	<b>525</b>	<b>1200</b>

Source: *The British Stainless Steel Association [BSSA]*

The stainless steel AISI 316L is an austenitic alloy. It is distinguished from others inoxidizable steels by the high percentage of molybdenum which gives it a special resistance to pitting corrosion and stress corrosion. In this kind of stainless steel, the percentage of nickel is increased to guarantee stability. Further, the “L” stands for low carbon and, in fact, the quantity is less than or equal to 0.03%. This feature prolongs the chrome carbide’s precipitation time and avoids the risk of intergranular corrosion during the welding process.

## ADA

The Americans with Disabilities Act of 2010 (ADA) states that door and gate hardware shall be operable with one hand and shall not require tight grasping, pinching or twisting of the wrist. Sculpted for hand free opening and closing, each pull presented in this brochure has a minimum opening width of 4” and a minimum opening depth of 1” (based on typical door). Operable with wrist, forearm or elbow and still operable by one hand with no pinching, wrist twisting, or simultaneous hand and finger manipulation required. All pulls in the collection were designed to comply with the ADA and similar accessibility requirements, however final interpretation of accessibility compliance is the responsibility of the specifier and should be determined relative to specific project conditions and local codes.

## PBA PRODUCTS CONTRIBUTE TOWARD SATISFYING PREREQUISITES AND CREDITS UNDER LEED®

LEED® (Leadership in Energy Environmental Design) is a voluntary certification system for the management, design and construction of buildings that are sustainable from a social, environmental and economic point of view and in terms of the wellbeing of the users. Established in the United States in 1993 by the U.S. Green Building Council (USGBC), LEED is now the most widespread building sustainability certification standard in the world. It considers every field that involves the design and management of buildings or neighbourhoods, both commercial and residential new or undergoing requalification.

## DECLARE LABEL



The Hands-Free Pull collection offers a Declare Label Red List Free - <https://declare.living-future.org/products/gmp-ghf-millwork-pulls-and-hands-free-pulls>  
The Declare Label is like a nutrition label for the building industry. It is a product transparency disclosure that lists the ingredients in products to help customers ensure healthier indoor living environments. It discloses where a product comes from, the materials it is made from, and its end-of-life pathway. The International Living Future Institute hosts a transparency platform and product database featuring Declare that helps stakeholders in the building industry find products free from hazardous substances. The Declare Label has been approved as a compliance pathway for the green building certification system LEED v4. Declare labels that achieve a declaration status of “Red List Free” fulfill the credit disclosure requirements. The Red List contains the worst in class materials prevalent in the building industry, which pollute the environment, bio-accumulate to toxic levels in the food chain, and/or are harmful to construction and factory workers.

## MAINTENANCE

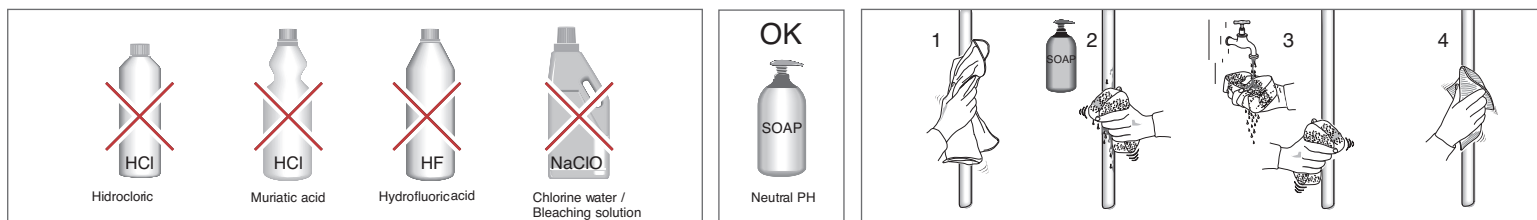

# GENERAL CONDITIONS OF SALE

## 1. AGREEMENT

1.1 The supply of the products shown in this pricelist ("Products") of PBA SpA ("PBA") shall be governed by these general conditions of sale ("General Conditions"). These General Conditions shall apply also to the sale of spare parts, when possible.

1.2 The sale agreement of the Products ("Agreement") is entered into force among the parties upon the Client's receipt of PBA's order confirmation.

These General Conditions shall be deemed as an integral and essential part of any Agreement.

1.3 These General Conditions shall be executed by the Client and attached to the first purchase order sent to PBA, it being agreed that they shall accordingly apply to any following Agreement.

1.4 These General Conditions shall be deemed as tacitly accepted by the Client for any supply of Products, unless expressly rejected in writing by the Client by means of notice thereof to be sent to PBA at the latest within 5 (five) days as of the date of receipt of PBA's confirmation of the first purchase order sent by the Client.

Should the Client expressly reject one or more of these General Conditions within the above term, PBA shall be free to withdraw from the relevant Agreement, by means of written communication thereof and without any further obligation.

1.5 In no event shall any general conditions of any nature, inserted and/or specified in the Client's order forms and/or in other documents sent to PBA by the Client, and/or of which the latter was made aware in any manner whatsoever, apply to any Agreement and/or to any supply of Products.

Any special term and/or condition of supply suggested by the Client shall apply to the Agreement only if expressly contained in PBA's order confirmation.

Any change and/or amendment to these General Conditions shall be binding and valid only if accepted in writing by both parties.

## 2. PLACE AND TERMS OF DELIVERY OF THE PRODUCTS

2.1 The choice of an Incoterm does not affect the location of the place of delivery of the Products which, in any case, shall be deemed as delivered to the Client at the place and in the moment in which they are put at disposal of the haulier, for the relevant transport, at PBA's premises in Tezze sul Brenta (Vicenza), Italy.

In any case, unless otherwise agreed in writing by the parties, PBA shall never be liable for delays accrued during the transportation.

2.2 The terms of delivery of the Products (i) are specified in PBA's order confirmation, (ii) are approximate and roughly set forth and (iii) in no case shall they be construed as of essence.

2.3 In case of delay in the delivery of the Products at PBA's premises, caused by a fortuitous event, force majeure or other causes not depending on PBA's willful misconduct and/or gross negligence, the Client shall not be entitled to claim any compensation for damages, nor to ask for the termination of the Agreement and/or for the reduction of the price of the Products.

## 3. INCOTERMS

Unless otherwise agreed in writing, the Products and the relevant prices are to be considered with delivery Ex-works (EXW – Incoterms 2000), PBA's premises in Tezze sul Brenta (VI), Italy or at the different place indicated by PBA in the notice Products ready for delivery.

## 4. ORDERS – NON STANDARD AND/OR MADE TO MEASURE PRODUCTS

4.1 The purchase orders shall be made in writing and completed with all the data required for the relevant design and manufacture.

4.2 When already approved by the Client for the supply of catalogue Products, it is agreed that these General Conditions shall also apply to the sale orders related to non standard Products, Products out of catalogue and/or to be made to measure, if confirmed by PBA.

4.3 Any delay of the Client in the transmission of data, measures and/or technical specifications of the Products subject matter of the Agreement may cause a proportional postponement of the delivery terms, to be newly determined by PBA on the basis of its industrial needs.

## 5. PRICES AND PAYMENTS

5.1 The prices of the Products indicated in this pricelist are merely indicative and can be modified at any time by PBA.

The actual price of the Products is specified in PBA's order confirmation and, unless otherwise specified, it is deemed as net of VAT.

Any change and/or modification of the Products, agreed by the parties after the transmission of PBA's order confirmation, shall cause the adjustment of the relevant price due to any increase of the costs of production and/or of the raw materials, as agreed from time to time by the parties.

5.2 The price of the Products shall be paid by the Client as per the terms and ways specified in PBA's order confirmation, or otherwise agreed by the parties.

Any late collection or non collection of the Products shall not cause an extension and/or postponement of the terms of payment.

5.3 PBA shall be entitled to suspend the delivery of the Products should: (a) the Client's assets and/or financial standings endanger the relevant payment; (b) the Client fail to timely pay Products previously supplied by PBA, also on the basis of other Agreements, until full payment of the outstanding credit and/or until receipt of proper guarantees of the Client for any delivery in progress, without prejudice to PBA's right to claim for any damages suffered as a consequence thereof.

5.4 In no event shall any vice and/or defect of the Products, even when expressly acknowledged as such by PBA, and/or any delay of delivery as to the agreed terms give the Client the right to suspend the relevant payments and/or any other payment for whichever reason due to PBA also under other contractual relationships.

5.5 In case of late payments, PBA shall be entitled to charge interests on the unpaid amount at the rate provided by the law.

5.6 In no case shall the Client be entitled to set off any amount due to PBA in force of any Agreement against any amount due by PBA at any title whatsoever.

## 6. RETENTION OF TITLE

PBA shall be the sole owner of the Products until the date of their full payment.

Should the Agreement be terminated due to the Client's breach of contract, any Client's advance payment shall be kept by PBA as an indemnity within the limits set forth by the law, without prejudice to the latter's right to claim for further damages.

## 7. WARRANTY

7.1 PBA guarantees that the Products will be free from vices and defects in materials and workmanship for a period of 24 (twenty-four) months as of the date of the relevant delivery ("Warranty Period").

7.2 Should the complaints raised by the Client within the Warranty Period with reference to the Products be grounded and accepted by PBA, the latter shall, at its exclusive discretion, repair and/or replace the defective Product/s or the defective component/s of the same, with delivery Ex-works (EXW Incoterms 2000) PBA's premises in Tezze sul Brenta (VI), Italy.

The warranty obligations herewith undertaken shall be effective and binding only provided that PBA has the opportunity to verify the vices and/or defects raised by the Client.

PBA's warranty obligation shall be deemed as entirely fulfilled with the removal of the vice and/or defect raised by the Client, or with the replacement of the defective Product and/or component, without any further obligations.

Unless otherwise agreed in writing by the parties, all the expenses for returning to PBA the defective Products and/or components, as well as all the additional expenses related to the operations of repair or replacement shall be borne by the Client and shall be at the Client's risk.

7.3 Subject to the loss of warranty, the Client shall notify in writing, by registered letter return receipt requested, any vices and/or defects found within and not later than 8 (eight) days as of the date of the actual delivery of the Products, or, in case of hidden vices or defects, within and not later than 8 (eight) days as of the date of the relevant discovery.

7.4 The warranty is expressly excluded for vices and/or defects of the Products arising from or consisting in:

- (i) any repair, alteration and/or modification not authorized in writing by PBA;
- (ii) normal wear and tear of the materials or of single components;
- (iii) improper use and/or application of the Products;
- (iv) defects and/or mistakes in the measures and/or technical specifications supplied by the Client;
- (v) deposit, maintenance and/or cleaning not in compliance with PBA's instructions;
- (vi) installation not in compliance with PBA's instructions and/or carried out with non suitable materials;
- (vii) any other event for which PBA is not directly liable.

Should the Client fail to regularly pay the agreed price, even if such default or such delay concerns a single part of the aggregate price of the Products, the warranty shall not apply.

7.5 Without prejudice to the compulsory product's liability law and any liability for willful misconduct and/or gross negligence, PBA shall not be liable for direct, indirect or incidental damages caused to the Client and and/or to third parties as a consequence of the defects of the Products. The Client shall not be entitled to terminate the Agreement in case of vices and/or defects of the Products subject matter of this warranty, should PBA timely comply with the relevant obligations.

7.6 The Products made of wood, pvc, rubber, rolled sections and/or of other natural materials shall be of a quality equal, within the limits of a reasonable similarity, to the relevant samples examined by the Client before the execution of the Agreement.

In no case shall therefore the samples of the Products examined by the Client be qualified as the exclusive standard for the exterior appearance of the Products.

Without prejudice to the warranty regulated by this clause 7, any chromatic and/or aesthetic difference (nervation of the wood, intensity of the colour shades, etc.) of the delivered Products compared to the characteristics of the relevant samples examined by the Client, shall not entitle the latter to terminate the Agreement and/or to ask for the replacement of the Products or for the reduction of the price.

7.7 In no event shall the chromatic differences between Products of the same type and/or colour, delivered with different lots and/or in different moments, be qualified as vices and/or defects of the Products, nor shall the Client be entitled to claim their replacement and/or the reduction of the relevant price as a consequence thereof.

## 8. MISPRINTS AND PRINTING ERRORS

We are not responsible for any misprint or printing error in catalogs or price lists. All images and sizes are not binding. Modifications are reserved. Design modifications are reserved to technically enhance products

## 9. EXCLUSIVE COURT

All disputes arising out of or relating to these General Conditions, any Agreement and/or to the supply of Products shall be exclusively submitted to and settled by the Court of Vicenza, Italy.

PBA shall in any case be entitled, at its exclusive discretion, to institute legal proceedings against the Client before the Court of the place where the Client has its registered office.

## 10. APPLICABLE LAW

These General Conditions of sale and any Agreement shall be governed by Italian Law.

Should the Client be a foreign entity or in any case an entity having the registered office or the main place of business abroad, the Contracts related to the supply of the Products shall in any case be regulated by the United Nations Convention on the International Sale of Goods (Wien Convention, April 11, 1980)

## 11. WAIVER

Failure by PBA to enforce at any time the provisions of these General Conditions shall not be construed as a waiver of such provision or of the right to thereafter enforce each and every provision herein.

## 12. LANGUAGE

The Client executes these General Conditions in Italian and in English, it being agreed that should any conflict or inconsistency arise among the two versions, the Italian wording shall always prevail.



