

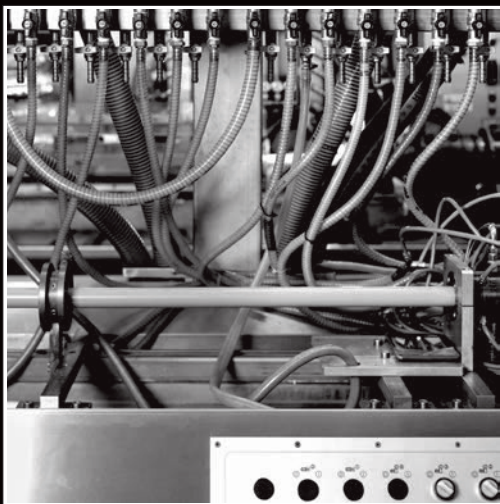

JUST BUILD IT

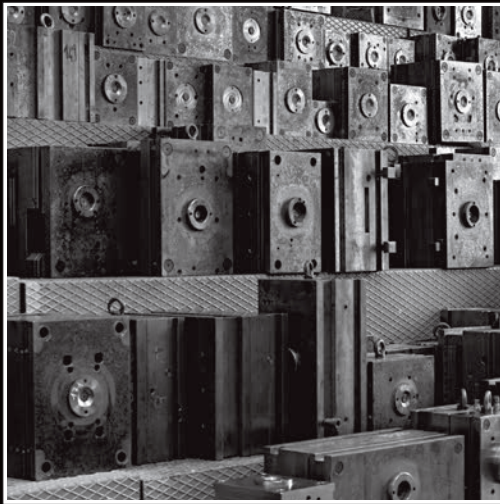

MADE
IN ITALY

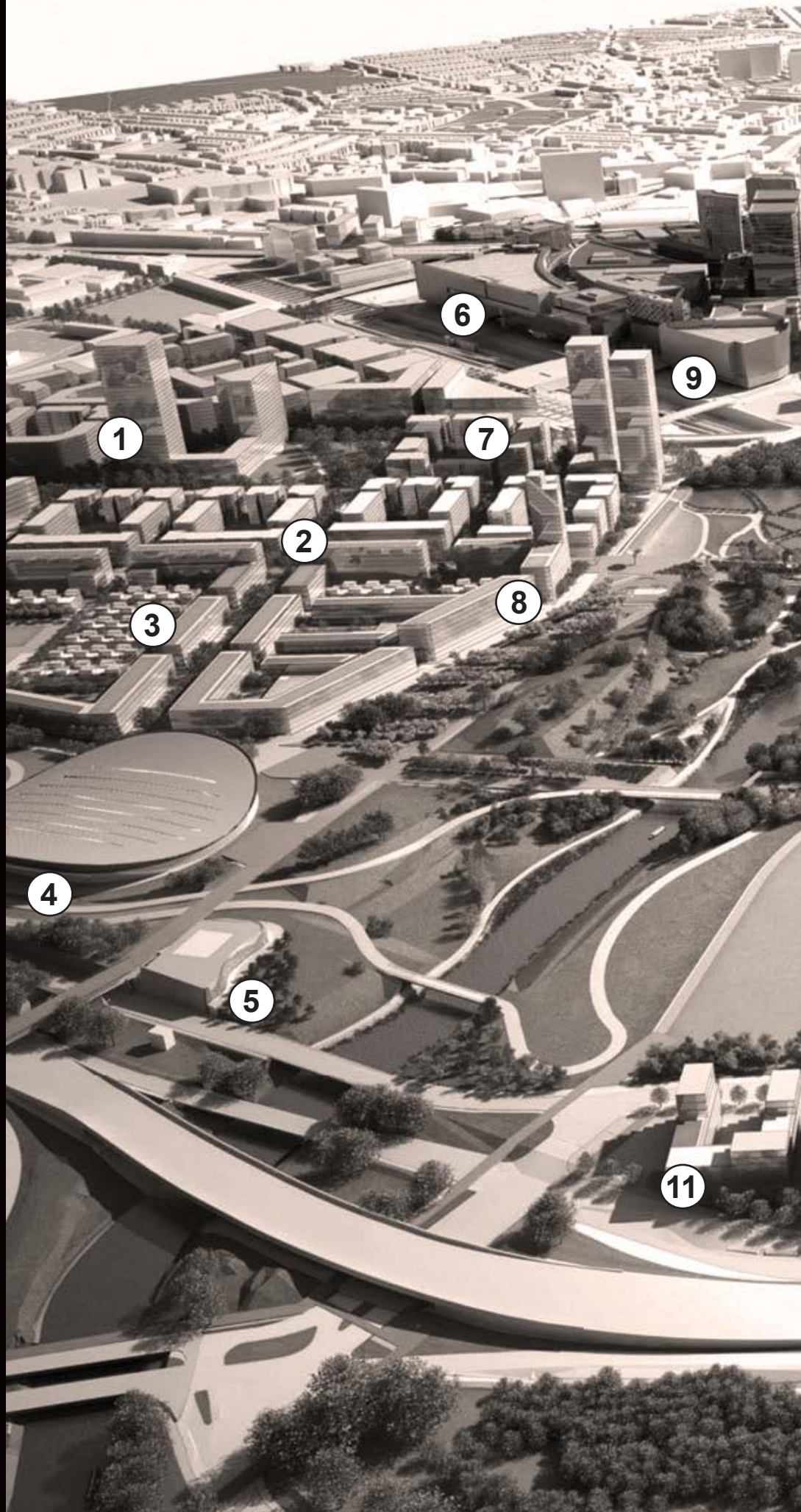

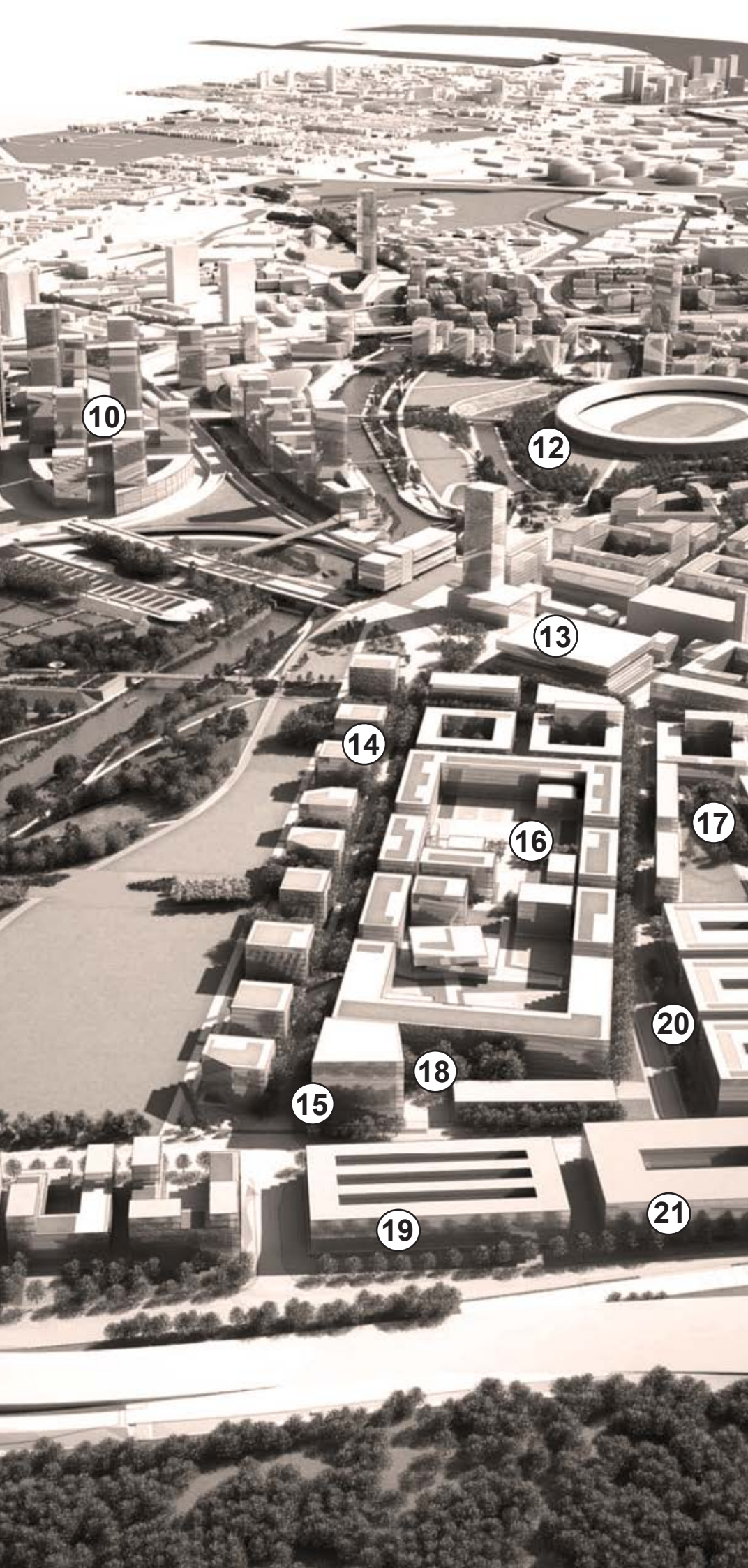

- 1 HOSPITAL
- 2 RESIDENCE
- 3 SPORTS COURT
- 4 AIRPORT
- 5 TRAIN STATION
- 6 MALL
- 7 REST HOME
- 8 EXHIBITION CENTER
- 9 OFFICE BUILDING
- 10 HOTEL
- 11 SPA & WELLNESS CENTRE
- 12 STADIUM
- 13 SWIMMING POOL
- 14 VILLAS
- 15 BANK
- 16 UNIVERSITY
- 17 CAMPUS
- 18 LIBRARY
- 19 MUSEUM
- 20 AUDITORIUM
- 21 CONCERT HALL

IDEA INTERNATIONAL DESIGN
EXCELLENCE AWARDS
FINALIST



V ADI CERAMICS & BATHROOM
DESIGN AWARD
SPECIAL MENTION



XXIII COMPASSO D'ORO
AWARD NOMINATION



REDDOT DESIGN AWARD
WINNER



reddot design award

REDDOT DESIGN AWARD
NOMINATION



reddot design award

XXI COMPASSO D'ORO
AWARD NOMINATION









PULL HANDLES
Aluminium
Wood





PULL HANDLES
Stainless steel AISI 316L
Wood

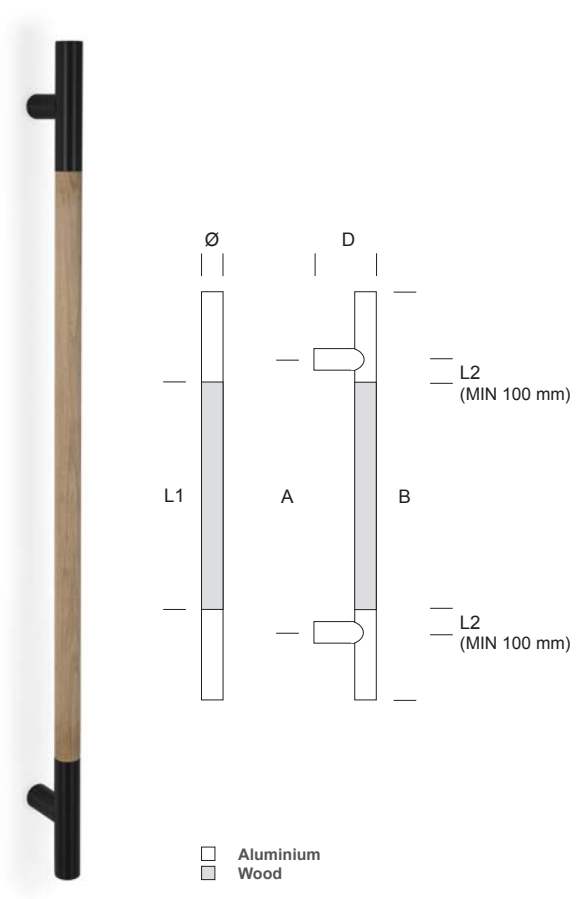

ART.	A	B	Ø	D	L1
2WA.253.T999 .68			30 mm	75 mm	custom

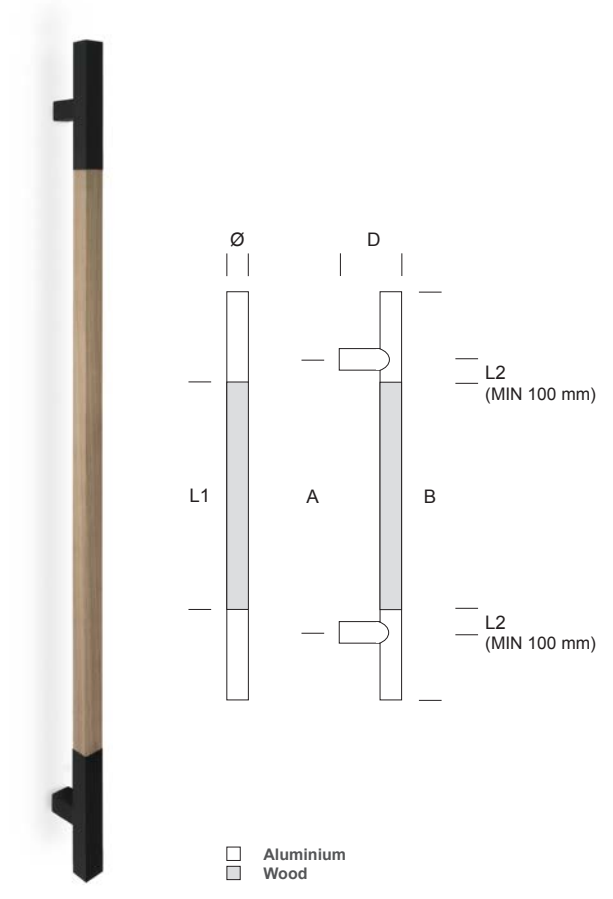

ART.	A	B	Ø	D	E	L1
2WA.121.Q999 .68			30 mm	88 mm	74 mm	custom

ALLUMINIO + LEGNO - ROVERE .XX FINISH
 ALUMINIUM + WOOD - OAK .68
 ALUMINIUM + BOIS - CHÊNE
 ALUMINIUM + MASSIVHOLZ - EICHE

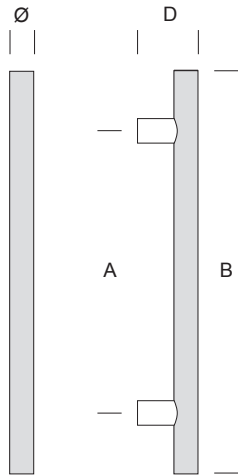

Stainless steel
 Wood

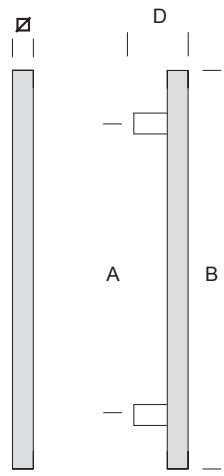

Stainless steel
 Wood

ART.	A	B	D	Ø
2WC.253.T999 .xx			75 mm	30 mm

ART.	A	B	D	Ø
2WC.121.Q999 .xx			75 mm	30 mm

ACCIAIO INOX	+ LEGNO - ROVERE	.XX FINISH
STAINLESS STEEL	+ WOOD - OAK	
ACIER INOX	+ BOIS - CHÊNE	.44
EDELSTAHL ROSTFREI	+ MASSIVHOLZ - EICHE	
		SATIN
		.43
		BRIGHT







MIO

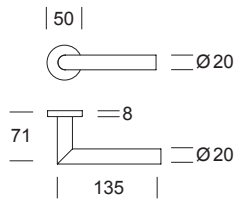

LEVER HANDLES
Stainless steel AISI 316L
Matte powder coated





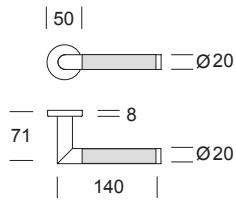

Matte powder coated

ART.
   **2MH.030.00T8 . xx**
  **2MH.030.0UT8 . xx**





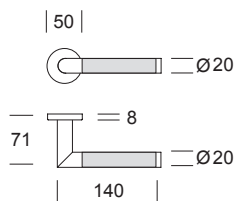

Matte powder coated
 Leather



ART.
   **2MH.030.0LT8 . xx**
  **2MH.030.0LT8 . xx**



Matte powder coated
 Wood

ART.
   **2MH.030.0WT8 . xx**
  **2MH.030.0WT8 . xx**



ART.
 **2MH.028.0TY8 . xx**
 **2MH.028.0TP8 . xx**
 Matte powder coated

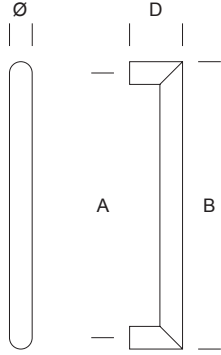

ART.	A	B	Ø	D
2CH.260.0025 .xx	250 mm	270 mm	20 mm	60 mm

Matte powder coated



.31 .40

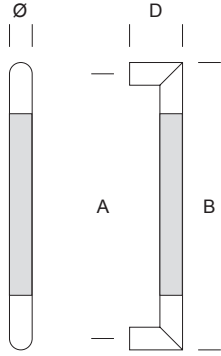

ART.	A	B	Ø	D
2CH.260.0L25 .xx	250 mm	270 mm	20 mm	60 mm

Matte powder coated
 Leather



.31 .40

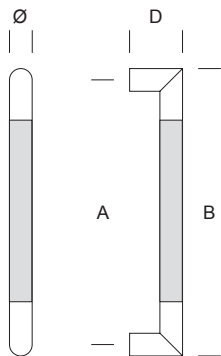

ART.	A	B	Ø	D
2CH.260.0W25 .xx	250 mm	270 mm	20 mm	60 mm

Matte powder coated
 Wood



.31 .40





LEVER HANDLES
Aluminium
Leather

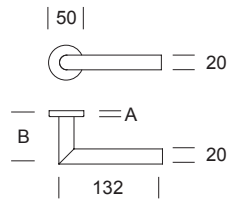

Aluminium

ART. A B
2AM.030.00T8 .xx 8 mm 65 mm



2AM.030.00T4 .xx 4 mm 60 mm
 Rosetta tonda bassa in acciaio verniciato
 Rose low round in stainless steel powder coated
 (Bronze - Black - Silver)

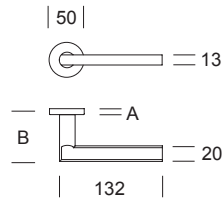

Aluminium

ART. A B
2AM.173.00T8 .xx 8 mm 65 mm



2AM.173.00T4 .xx 4 mm 60 mm
 Rosetta tonda bassa in acciaio verniciato
 Rose low round in stainless steel powder coated
 (Bronze - Black - Silver)

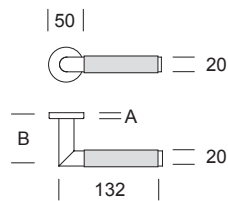

Aluminium
 Leather

ART. A B
2AM.030.0LT8 .68 8 mm 65 mm



ART.
 2AM.028.0TY8 .xx
 2AM.028.0TP8 .xx

Aluminium

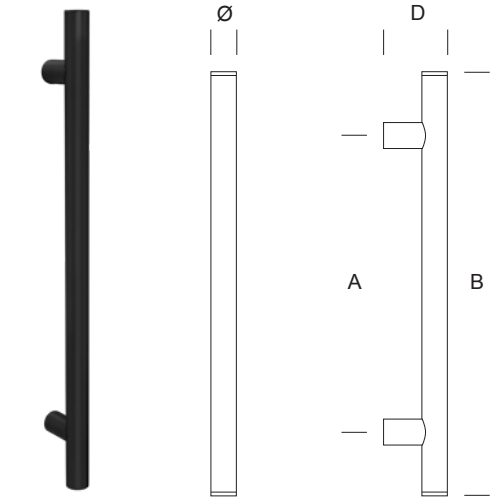

ART.	A	B	Ø	D
2AT.242.0025 .xx	250 mm	400 mm	25 mm	70 mm
2AT.243.0030 .xx	300 mm	450 mm	25 mm	70 mm
* 2AT.243.9999 .xx	custom	custom	25 mm	70 mm
* Supporto aggiuntivo necessario per A > 500 mm - The additional support is necessary for A > 500 mm				
2AT.252.0030 .xx	300 mm	450 mm	30 mm	75 mm
2AT.253.0035 .xx	350 mm	500 mm	30 mm	75 mm
* 2AT.253.9999 .xx	custom	custom	30 mm	75 mm
* Supporto aggiuntivo necessario per A > 600 mm - The additional support is necessary for A > 600 mm				
2AT.225.0035 .xx	350 mm	520 mm	35 mm	80 mm
2AT.226.0055 .xx	550 mm	720 mm	35 mm	80 mm
* 2AT.226.9999 .xx	custom	custom	35 mm	80 mm
* Supporto aggiuntivo necessario per A > 800 mm - The additional support is necessary for A > 800 mm				

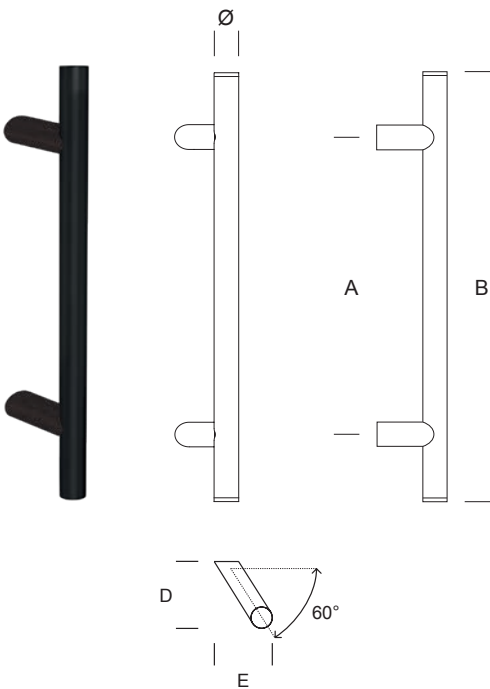
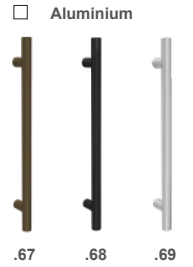

ART.	A	B	Ø	D	E
2AT.242.025I .xx	250 mm	400 mm	25 mm	84 mm	68 mm
2AT.243.030I .xx	300 mm	450 mm	25 mm	84 mm	68 mm
* 2AT.243.999I .xx	custom	custom	25 mm	84 mm	68 mm
* Supporto aggiuntivo necessario per A > 500 mm - The additional support is necessary for A > 500 mm					
2AT.252.030I .xx	300 mm	450 mm	30 mm	88 mm	74 mm
2AT.253.035I .xx	350 mm	500 mm	30 mm	88 mm	74 mm
* 2AT.253.999I .xx	custom	custom	30 mm	88 mm	74 mm
* Supporto aggiuntivo necessario per A > 600 mm - The additional support is necessary for A > 600 mm					

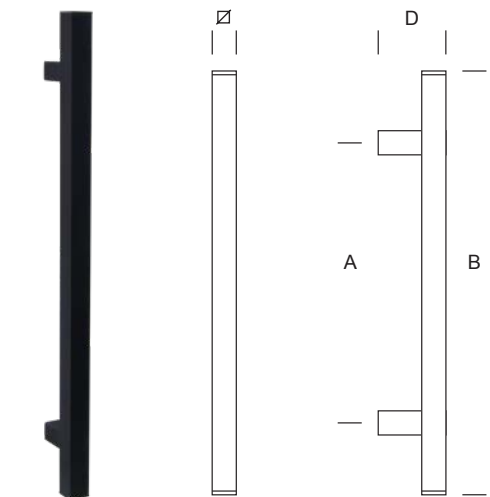

ART.	A	B	Ø	D
2AQ.111.0030 .xx	300 mm	450 mm	25 mm	70 mm
2AQ.112.0035 .xx	350 mm	500 mm	25 mm	70 mm
* 2AQ.112.9999 .xx	custom	custom	25 mm	70 mm
* Supporto aggiuntivo necessario per A > 650 mm - The additional support is necessary for A > 650 mm				
2AQ.121.0050 .xx	500 mm	650 mm	30 mm	75 mm
* 2AQ.121.9999 .xx	custom	custom	30 mm	75 mm
* Supporto aggiuntivo necessario per A > 800 mm - The additional support is necessary for A > 800 mm				
2AQ.131.0060 .xx	600 mm	770 mm	35 mm	80 mm
* 2AQ.131.9999 .xx	custom	custom	35 mm	80 mm
* Supporto aggiuntivo necessario per A > 1000 mm - The additional support is necessary for A > 1000 mm				



* Supporto aggiuntivo necessario per le misure contraddistinte da *, in mancanza di tale supporto la tenuta non viene garantita da pba

* The additional support is necessary for all the products marked with *, if the customer does not accept the additional support pba cannot guarantee the security and the duration of the fixing



PBA
PATENTED
SYSTEM



LOCKSET FOR FRAMELESS GLASS DOOR
Stainless steel AISI 316L



	S	ART.	◆
PASSAGE	10 mm	HGO.30C.0A10. xx . x	

	S	ART.	◆
PASSAGE	10 mm	HGO.028.0A10. xx . x	

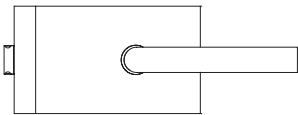

12 mm	HGO.30C.0A12. xx . x
-------	----------------------

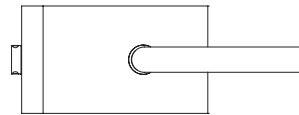

12 mm	HGO.028.0A12. xx . x
-------	----------------------

* SECURITY	10 mm	HGO.30C.0Y10. xx . x
------------	-------	----------------------

SECURITY	10 mm	HGO.028.0Y10. xx . x
----------	-------	----------------------

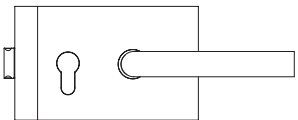

12 mm	HGO.30C.0Y12. xx . x
-------	----------------------

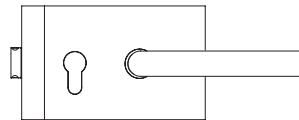

12 mm	HGO.028.0Y12. xx . x
-------	----------------------

* NON REVERSIBILE, INDICARE IL VERSO - NON-REVERSIBLE, PLEASE INDICATE THE OPENING DIRECTION - NON-RÉVERSIBLE, VEUILLEZ INDIQUER LA DIRECTION D'OUVERTURE - NICHT UMKEHRBAR, BITTE TEILEN SIE UNS DIE ÖFFNUNGSRICHTUNG MIT

ACCIAIO INOX
STAINLESS STEEL
ACIER INOX
EDELSTAHL ROSTFREI

.XX FINISH
.44
SATIN

CILINDRO NON INCLUSO
CYLINDER NOT INCLUDED
CYLINDRE NON INCLUS
ZYLINDER NICHT ENTHALTEN

◆
.1 DESTRO RIGHT DROITE RECHTS
.2 SINISTRO LEFT GAUCHE LINKS



	S	ART.	◆
PASSAGE	10 mm	HGO.28B.0A10. xx . x	

	S	ART.	◆
PASSAGE	10 mm	HGO.020.0A10. xx . x	

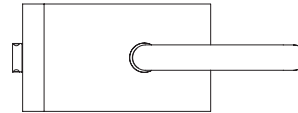
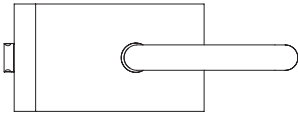

12 mm	HGO.28B.0A12. xx . x
-------	----------------------

12 mm	HGO.020.0A12. xx . x
-------	----------------------

* SECURITY	10 mm	HGO.28B.0Y10. xx . x
------------	-------	----------------------

SECURITY	10 mm	HGO.020.0Y10. xx . x
----------	-------	----------------------

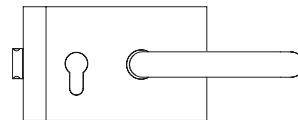
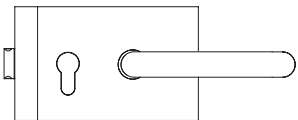

12 mm	HGO.28B.0Y12. xx . x
-------	----------------------

12 mm	HGO.020.0Y12. xx . x
-------	----------------------

* NON REVERSIBILE, INDICARE IL VERSO - NON-REVERSIBLE, PLEASE INDICATE THE OPENING DIRECTION - NON-RÉVERSIBLE, VEUILLEZ INDIQUER LA DIRECTION D'OUVERTURE - NICHT UMKEHRBAR, BITTE TEILEN SIE UNS DIE ÖFFNUNGSRICHTUNG MIT











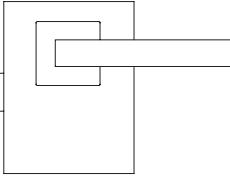

ACCIAIO INOX
STAINLESS STEEL
ACIER INOX
EDELSTAHL ROSTFREI

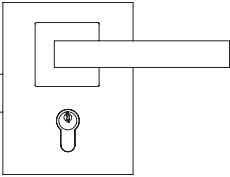



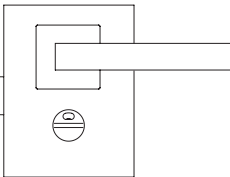





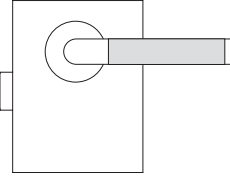

.XX FINISH
.44
SATIN

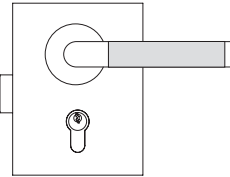
CILINDRO NON INCLUSO
CYLINDER NOT INCLUDED
CYLINDRE NON INCLUS
ZYLINDER NICHT ENTHALTEN

◆
.1 DESTRO RIGHT DROITE RECHTS
.2 SINISTRO LEFT GAUCHE LINKS

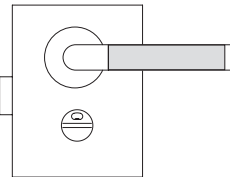

	S		ART.	◆
PASSAGE 	8 mm		HGL.LCK.0A08. xx . x 0IT.151.0000. xx	
	10 mm		HGL.LCK.0A10. xx . x 0IT.151.0000. xx	
	12 mm		HGL.LCK.0A12. xx . x 0IT.151.0000. xx	
SECURITY 	8 mm		HGL.LCK.0Y08. xx . x 0IT.151.0000. xx	
	10 mm		HGL.LCK.0Y10. xx . x 0IT.151.0000. xx	
	12 mm		HGL.LCK.0Y12. xx . x 0IT.151.0000. xx	
PRIVACY 	8 mm		HGL.LCK.3H08. xx . x 0IT.151.0000. xx	
	10 mm		HGL.LCK.3H10. xx . x 0IT.151.0000. xx	
	12 mm		HGL.LCK.3H12. xx . x 0IT.151.0000. xx	

	S		ART.	◆
PASSAGE 	8 mm		HGL.LCK.0A08. xx . x YOD.003.00T8. xx	
	10 mm		HGL.LCK.0A10. xx . x YOD.003.00T8. xx	
	12 mm		HGL.LCK.0A12. xx . x YOD.003.00T8. xx	
SECURITY 	8 mm		HGL.LCK.0Y08. xx . x YOD.003.00T8. xx	
	10 mm		HGL.LCK.0Y10. xx . x YOD.003.00T8. xx	
	12 mm		HGL.LCK.0Y12. xx . x YOD.003.00T8. xx	
PRIVACY 	8 mm		HGL.LCK.3H08. xx . x YOD.003.00T8. xx	
	10 mm		HGL.LCK.3H10. xx . x YOD.003.00T8. xx	
	12 mm		HGL.LCK.3H12. xx . x YOD.003.00T8. xx	

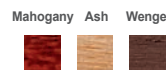

◆
 .1 DESTRO RIGHT DROITE RECHTS
 .2 SINISTRO LEFT GAUCHE LINKS

ACCIAIO INOX
 STAINLESS STEEL
 ACIER INOX
 EDELSTAHL ROSTFREI

.XX FINISH
 .44 SATIN
 .43 BRIGHT

A RICHIESTA FINITURA ACCIAIO INOX VERNICIATO - PVD
 ON REQUEST FINISH STAINLESS STEEL POWDER COATED - PVD
 A LA DEMANDE FINITION ACIER INOXIDABLE LAQUÉ - PVD
 AUF ANFRAGE AUSFÜHRUNGEN EDELSTAHL ROSTFREI LACKIERT - PVD

CILINDRO NON INCLUSO
 CYLINDER NOT INCLUDED
 CYLINDRE NON INCLUS
 ZYLINDER NICHT ENTHALTEN



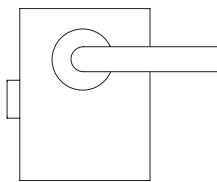
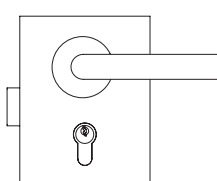
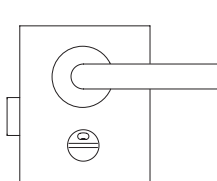

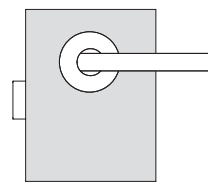
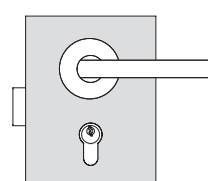
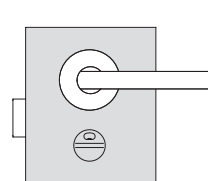
	S	ART.	◆
PASSAGE 	8 mm	HGL.LCK.0A08. xx . x 2MM.20S.00T8. xx	
	10 mm	HGL.LCK.0A10. xx . x 2MM.20S.00T8. xx	
	12 mm	HGL.LCK.0A12. xx . x 2MM.20S.00T8. xx	
SECURITY 	8 mm	HGL.LCK.0Y08. xx . x 2MM.20S.00T8. xx	
	10 mm	HGL.LCK.0Y10. xx . x 2MM.20S.00T8. xx	
	12 mm	HGL.LCK.0Y12. xx . x 2MM.20S.00T8. xx	
PRIVACY 	8 mm	HGL.LCK.3H08. xx . x 2MM.20S.00T8. xx	
	10 mm	HGL.LCK.3H10. xx . x 2MM.20S.00T8. xx	
	12 mm	HGL.LCK.3H12. xx . x 2MM.20S.00T8. xx	

	S	ART.	◆
PASSAGE 	8 mm	HGL.LCK.0A08. xx . x 2AM.173.00T8. xx	
	10 mm	HGL.LCK.0A10. xx . x 2AM.173.00T8. xx	
	12 mm	HGL.LCK.0A12. xx . x 2AM.173.00T8. xx	
SECURITY 	8 mm	HGL.LCK.0Y08. xx . x 2AM.173.00T8. xx	
	10 mm	HGL.LCK.0Y10. xx . x 2AM.173.00T8. xx	
	12 mm	HGL.LCK.0Y12. xx . x 2AM.173.00T8. xx	
PRIVACY 	8 mm	HGL.LCK.3H08. xx . x 2AM.173.00T8. xx	
	10 mm	HGL.LCK.3H10. xx . x 2AM.173.00T8. xx	
	12 mm	HGL.LCK.3H12. xx . x 2AM.173.00T8. xx	



Alluminio - Aluminium
 Verniciato - Powder Coated

◆
 .1 DESTRO RIGHT DROITE RECHTS
 .2 SINISTRO LEFT GAUCHE LINKS

ACCIAIO INOX
STAINLESS STEEL
ACIER INOX
EDELSTAHL ROSTFREI

.XX FINISH
 **.44**
 SATIN
 **.43**
 BRIGHT

A RICHIESTA FINITURA ACCIAIO VERNICIATO - PVD
 ON REQUEST FINISH S.STEEL POWDER COATED - PVD
 A LA DEMANDE FINITION ACIER LAQUÉ - PVD
 AUF ANFRAGE AUSFÜHRUNGEN EDELSTAHL - PVD

.XX FINISH
 Silver
 Bronze
 Black

CILINDRO NON INCLUSO
 CYLINDER NOT INCLUDED
 CYLINDRE NON INCLUS
 ZYLINDER NICHT ENTHALTEN



P B A
PATENTED
SYSTEM



COMPASSO D'ORO
AWARD NOMINATION



LOCKING LADDER PULLS

Aluminium and Stainless steel AISI 316L

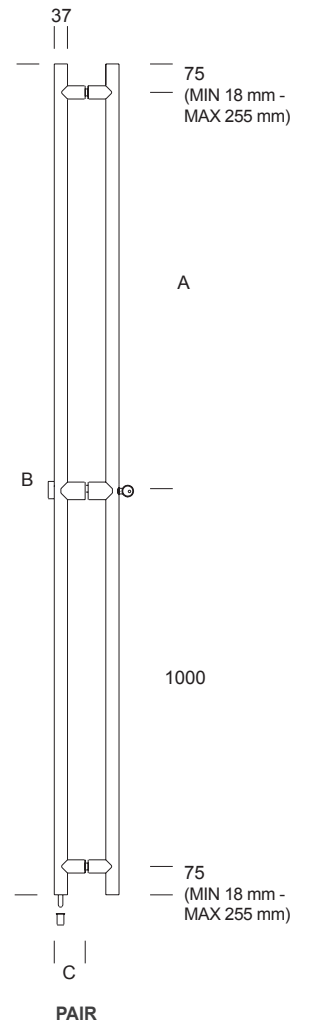
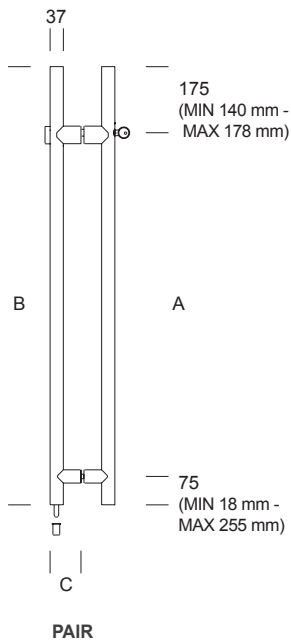

PAIR	ART.	A	B	C
	KLA.Y02.0000. xx	1000 mm	1250 mm	85 mm
	KLA.Y02.9999. xx			85 mm

PAIR	ART.	A	B	C
	KLA.Y04.0000. xx	1050 mm	2200 mm	85 mm
	KLA.Y04.9999. xx			85 mm
	KLA.Y06.0000. xx	1050 mm	2200 mm	85 mm
	KLA.Y06.9999. xx			85 mm



EUROPEAN
PROFIL CYLINDER
INCLUDED

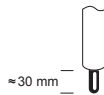

PUNTALE REGOLABILE
ADJUSTABLE STEEL
DEAD BOLT
PIVOT RÉGLABLE
REGULIERBARER
SCHLISSANKER
REGELBARE
ONDOORZAAGBARE
SLUITSTANG



POZZETTO
ANTIPOLVERE
DUST-FREE
FLOOR SOCKET
GÂCHE ANTI-
POUSSIÈRE
ANTISTAUB
BODENBÜCHSE
VLOERPOT MET
ANTI-STOFBESCHERMING

ALLUMINIO ALUMINIUM ALUMINIUM ALUMINIUM	.XX FINISH
	.69
	.67
	.68

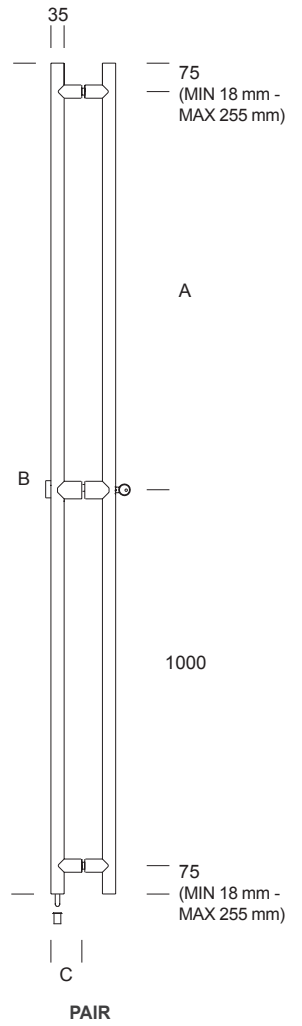
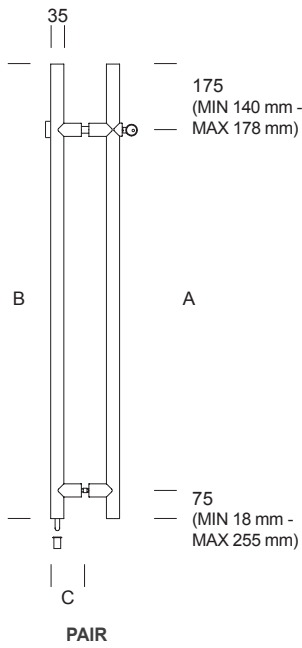

PAIR	ART.	A	B	C
	KLO.Y02.0000. xx	1000 mm	1250 mm	80 mm
	KLO.Y02.9999. xx			80 mm

PAIR	ART.	A	B	C
	KLO.Y04.0000. xx	1050 mm	2200 mm	80 mm
	KLO.Y04.9999. xx			80 mm
	KLO.Y06.0000. xx	1050 mm	2200 mm	80 mm
	KLO.Y06.9999. xx			80 mm



EUROPEAN
PROFIL CYLINDER
INCLUDED

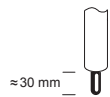

PUNTALE REGOLABILE
ADJUSTABLE STEEL
DEAD BOLT
PIVOT RÉGLABLE
REGULIERBARER
SCHLIESSANKER
REGELBARE
ONDOORZAAGBARE
SLUITSTANG



POZZETTO
ANTIPOLVERE
DUST-FREE
FLOOR SOCKET
GÂCHE ANTI-
POUSSIÈRE
ANTISTAUB
BODENBUCHSE
VLOERPOT MET
ANTI-STOFBESCHERMING

ACCIAIO INOX
STAINLESS STEEL
ACIER INOX
EDELSTAHL ROSTFREI

.XX FINISH
.44 **.43**
SATIN BRIGHT

A RICHIESTA FINITURA ACCIAIO INOX VERNICIATO
ON REQUEST FINISH STAINLESS STEEL POWDER COATED
A LA DEMANDE FINITION ACIER INOXIDABLE LAQUÉ
AUF ANFRAGE AUSFÜHRUNGEN EDELSTAHL ROSTFREI LACKIERT

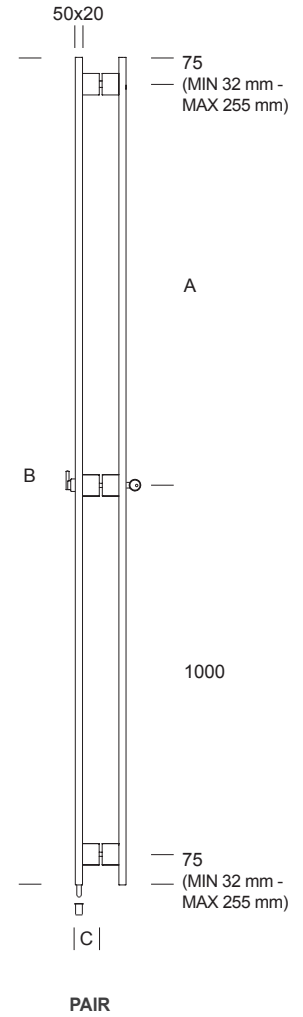
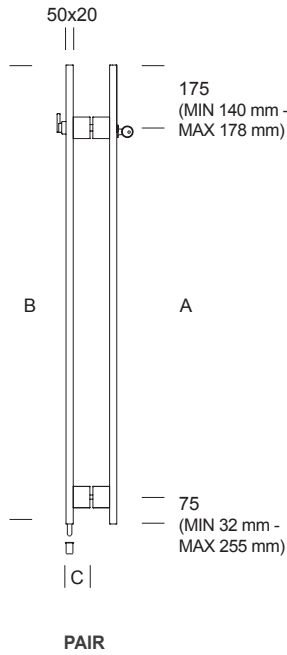

PAIR	ART.	A	B	C
	KLP.FY2.0000. xx	1000 mm	1250 mm	67 mm
	KLP.FY2.9999. xx			67 mm

PAIR	ART.	A	B	C
	KLP.FY4.0000. xx	1050 mm	2200 mm	67 mm
	KLP.FY4.9999. xx			67 mm

PAIR	ART.	A	B	C
	KLP.FY6.0000. xx	1050 mm	2200 mm	67 mm
	KLP.FY6.9990. xx			67 mm



EUROPEAN
PROFIL CYLINDER
INCLUDED

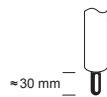

PUNTALE REGOLABILE
ADJUSTABLE STEEL
DEAD BOLT
PIVOT RÉGLABLE
REGULIERBARER
SCHLIESSANKER
REGELBARE
ONDOORZAAGBARE
SLUITSTANG



POZZETTO
ANTIPOLVERE
DUST-FREE
FLOOR SOCKET
GÂCHE ANTI-
POUSSIÈRE
ANTISTAUB
BODENBUCHSE
VLOERPOT MET
ANTI-STOFBESCHERMING

ACCIAIO INOX
STAINLESS STEEL
ACIER INOX
EDELSTAHL ROSTFREI

.XX FINISH

.44
SATIN

.43
BRIGHT

A RICHIESTA FINITURA ACCIAIO INOX VERNICIATO
ON REQUEST FINISH STAINLESS STEEL POWDER COATED
A LA DEMANDE FINITION ACIER INOXIDABLE LAQUÉ
AUF ANFRAGE AUSFÜHRUNGEN EDELSTAHL ROSTFREI LACKIERT



FOTO INDICATIVA
INDICATIVE PHOTO
PHOTO INDICATIVE
BEISPIELBILD

PAIR	ART.	A	B	C
	KLL.002.999U. xx			80 mm

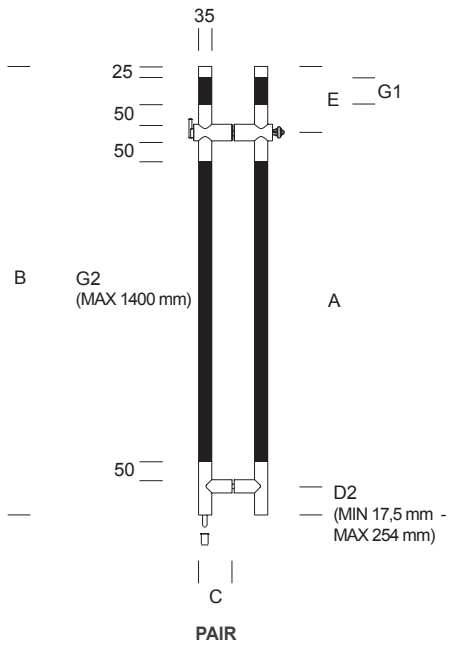

FOTO INDICATIVA
INDICATIVE PHOTO
PHOTO INDICATIVE
BEISPIELBILD

PAIR	ART.	A	B	C
	KLL.004.999U. xx			80 mm
	KLL.006.999U. xx			80 mm

PELLE A SORMONTO
OVERLAPPED LEATHER
CUIR DE CHEVAUCHEMENT
ÜBERLAPPENDES LEDER

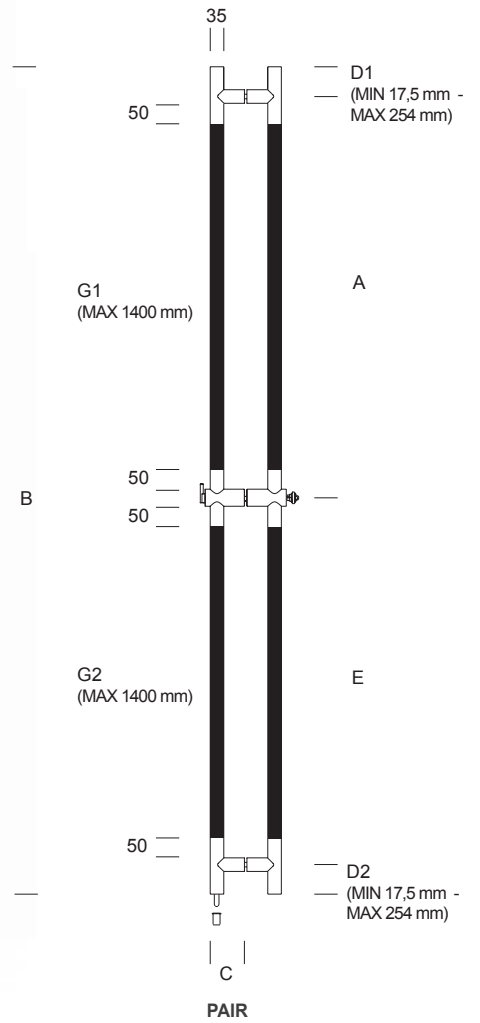

RIM CYLINDER
WITH IC



POMOLO CONFORME
NORMATIVA ADA
ADA COMPLIANT
THUMBTURN
BOUTON CORRESPON-
DANT AUX NORMES ADA
KNAUF GEMÄSS ADA
NORMEN
DEURKNOP VOLGENS
ADA NORMEN

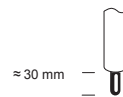

PUNTALE REGOLABILE
ADJUSTABLE STEEL
DEAD BOLT
PIVOT RÉGLABLE
REGULIERBARER
SCHLIESSANKER
REGELBARE
ONDOORZAAGBARE
SLUITSTANG



POZZETTO
ANTIPOLVERE
DUST-FREE
FLOOR SOCKET
GÂCHE ANTI-
POUSSIÈRE
ANTISTAUB
BODENBUCHSE
VLOERPOT MET
ANTI-STOFBESCHERMING

ACCIAIO INOX
STAINLESS STEEL
ACIER INOX
EDELSTAHL ROSTFREI

.XX FINISH

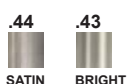

A RICHIESTA FINITURA ACCIAIO INOX VERNICIATO
ON REQUEST FINISH STAINLESS STEEL POWDER COATED
A LA DEMANDE FINITION ACIER INOXIDABLE LAQUÉ
AUF ANFRAGE AUSFÜHRUNGEN EDELSTAHL ROSTFREI LACKIERT

PELLE
LEATHER
CUIR
LEDER



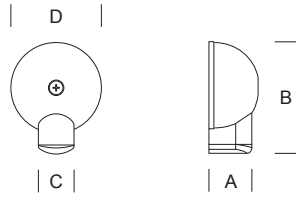

ART.	A	B	C	D
2MM.040.0000.xx	24 mm	60 mm	20 mm	50 mm

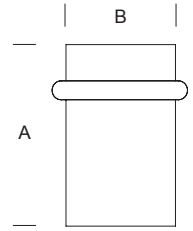

ART.	A	B
2MM.041.0000.xx	40 mm	29 mm

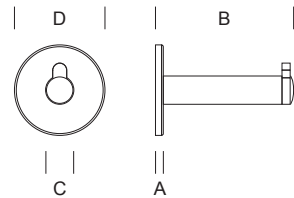

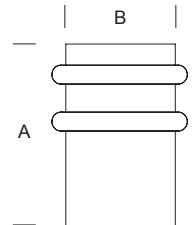

ART.	A	B	C	D
5CS.562.0000.xx	4 mm	76 mm	16 mm	50 mm



ART.	A	B
2MM.043.0000.xx	40 mm	29 mm



ACCIAIO INOX
STAINLESS STEEL
ACIER INOX
EDELSTAHL ROSTFREI

.XX FINISH
 .44 SATIN
 .43 BRIGHT

A RICHIESTA FINITURA PVD
ON REQUEST FINISH PVD
A LA DEMANDE FINITION PVD
AUF ANFRAGE AUSFÜHRUNGEN PVD

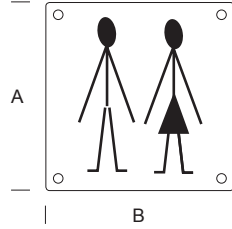

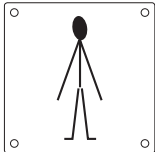
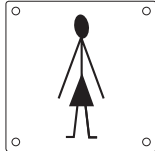
A RICHIESTA FINITURA ACCIAIO INOX VERNICIATO
ON REQUEST FINISH STAINLESS STEEL POWDER COATED
A LA DEMANDE FINITION ACIER INOXIDABLE LAQUÉ
AUF ANFRAGE AUSFÜHRUNGEN EDELSTAHL ROSTFREI LACKIERT



	ART.	A	B
	□ 2MM.401.000U. xx	150 mm	150 mm
	□ 2MM.402.000U. xx	150 mm	150 mm
	□ 2MM.403.000U. xx	150 mm	150 mm
	□ 2MM.404.000U. xx	150 mm	150 mm
	□ 2MM.406.000U. xx	150 mm	150 mm

	ART.	A	B
0	• □ 2MM.600.000P. xx	75 mm	4 mm
1	• □ 2MM.601.001P. xx	75 mm	4 mm
2	• □ 2MM.602.002P. xx	75 mm	4 mm
3	• □ 2MM.603.003P. xx	75 mm	4 mm
4	• □ 2MM.604.004P. xx	75 mm	4 mm
5	• □ 2MM.605.005P. xx	75 mm	4 mm
6	• □ 2MM.606.006P. xx	75 mm	4 mm
7	• □ 2MM.607.007P. xx	75 mm	4 mm
8	• □ 2MM.608.008P. xx	75 mm	4 mm
9	• □ 2MM.609.009P. xx	75 mm	4 mm
a	• □ 2MM.600.00AP. xx	55 mm	4 mm
b	• □ 2MM.600.00BP. ..	75 mm	4 mm
c	• □ 2MM.600.00CP. xx	55 mm	4 mm
d	• □ 2MM.600.00DP. xx	75 mm	4 mm

ACCIAIO INOX
STAINLESS STEEL
ACIER INOX
EDELSTAHL ROSTFREI

.XX FINISH
 .44 SATIN
 .43 BRIGHT

• = A RICHIESTA FINITURA PVD
ON REQUEST FINISH PVD
A LA DEMANDE FINITION PVD
AUF ANFRAGE AUSFÜHRUNGEN PVD

□ = A RICHIESTA FINITURA ACCIAIO INOX VERNICIATO
ON REQUEST FINISH STAINLESS STEEL POWDER COATED
A LA DEMANDE FINITION ACIER INOXIDABLE LAQUÉ
AUF ANFRAGE AUSFÜHRUNGEN EDELSTAHL ROSTFREI LACKIERT





HANDRAIL
Stainless steel AISI 316L
Wood

CORRIMANO CON SUPPORTO CURVATO Ø 20
 HANDRAIL WITH CURVED SUPPORT Ø 20
 MAIN COURANTE AVEC SUPPORT COUDÉ Ø 20
 HANDLAUF MIT GEBOGENER WANDSTÜTZE Ø 20 MM



Tratti piani
 Level surfaces
 Surfaces planes
 Flur

Tratti inclinati
 Sloping surfaces
 Surfaces inclinées
 Treppe

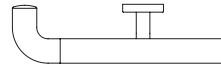
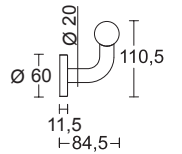
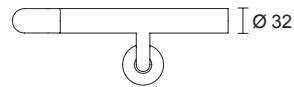
Calandrato
 Bended
 Circulaire
 Gebogen



ART.



-  4CS.00P.0001. xx
-  4CS.00P.0101. xx
-  4CS.00P.0301. xx

4CS.0SN.0000. xx
 (α = 150° - 180°)

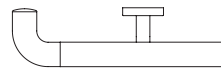
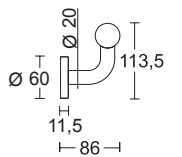
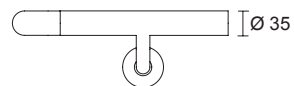
Corrimano in Acciaio Inox AISI 316L
 AISI 316L Stainless Steel handrail
 Main courante en Acier Inoxydable AISI 316L
 Handlauf aus Edelstahl 1.4404



ART.

-  4WP.001.0000. xx
-  4WP.101.0000. xx

4CS.WSN.0000. xx
 (α = 150° - 180°)

Corrimano in Legno di faggio con supporti in Acciaio Inox AISI 316L
 Wooden beech handrail with AISI 316L Stainless Steel supports
 Main courante en Hêtre avec supports en Acier Inox AISI 316L
 Handlauf aus Holz mit Wandstützen aus Edelstahl 1.4404

ACCIAIO INOX + LEGNO - FAGGIO
 STAINLESS STEEL + WOOD - BEECH
 ACIER INOX + BOIS - HÊTRE
 EDELSTAHL ROSTFREI + MASSIVHOLZ - BUCHE

.XX FINISH

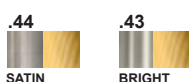

CORRIMANO CON SUPPORTO A 90°
 HANDRAIL WITH 90° SUPPORT
 MAIN COURANTE AVEC SUPPORT ANGLE DROIT À 90°
 HANDLAUF MIT 90°-WANDSTÜTZE

Tratti piani
 Level surfaces
 Surfaces planes
 Flur

Tratti inclinati
 Sloping surfaces
 Surfaces inclinées
 Treppe

Calandrato
 Bended
 Circulaire
 Gebogen

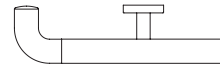
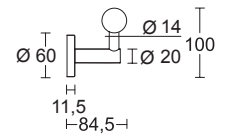
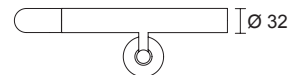

ART.

-  4CS.00R.0001. xx
-  4CS.00R.0101. xx
-  4CS.00R.0301. xx

4CS.0SN.0000. xx
 (α = 150° - 180°)

Corrimano in Acciaio Inox AISI 316L
 AISI 316L Stainless Steel handrail
 Main courante en Acier Inoxydable AISI 316L
 Handlauf aus Edelstahl 1.4404

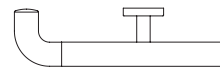
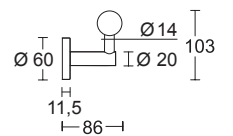
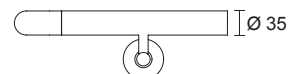



ART.

-  4WR.001.0000. xx
-  4WR.101.0000. xx

4CS.WSN.0000. xx
 (α = 150° - 180°)

Corrimano in Legno di faggio con supporti in Acciaio Inox AISI 316L
 Wooden beech handrail with AISI 316L Stainless Steel supports
 Main courante en Hêtre avec supports en Acier Inox AISI 316L
 Handlauf aus Holz mit Wandstützen aus Edelstahl 1.4404

ACCIAIO INOX	+ LEGNO - FAGGIO	.XX FINISH
STAINLESS STEEL	+ WOOD - BEECH	
ACIER INOX	+ BOIS - HÊTRE	.44
EDELSTAHL ROSTFREI	+ MASSIVHOLZ - BUCHE	
		
		SATIN BRIGHT



P B A
REGISTERED
MODELS



BATHROOM FOLDAWAY AIDS
Extruded, die-cast and
powder coated aluminium



ART.	A	B
CAP.445.000T .xx	600*	852*
CAP.445.0000 .xx	700*	952*

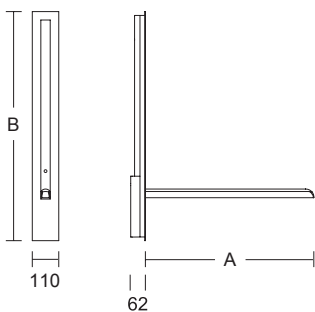

- Sostegno di sicurezza ribaltabile a scomparsa
- Lift-up foldaway safety support
- Barre d'appui relevable escamotable
- Stützklappgriff, versenkbar für Wandeinbau



ALLUMINIO VERNICIATO .XX FINISH
 POWDER COATED ALUMINIUM .30 .24
 ALUMINIUM LAQUE
 BESCHICHTETEM ALUMINIUM



ART.	A	B	C	D
CAP.447.000B .xx	460*	340*	450*	390*

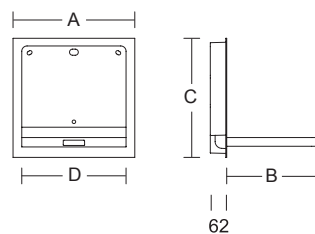

- Seggiolino ribaltabile a scomparsa
- Lift-up foldaway shower seat
- Siège relevable escamotable
- Klappsitz, versenkbar für Wandeinbau





PATENTED

ART. A
 4CA.445.000T .xx 600*
 4CA.445.0000 .xx 700*

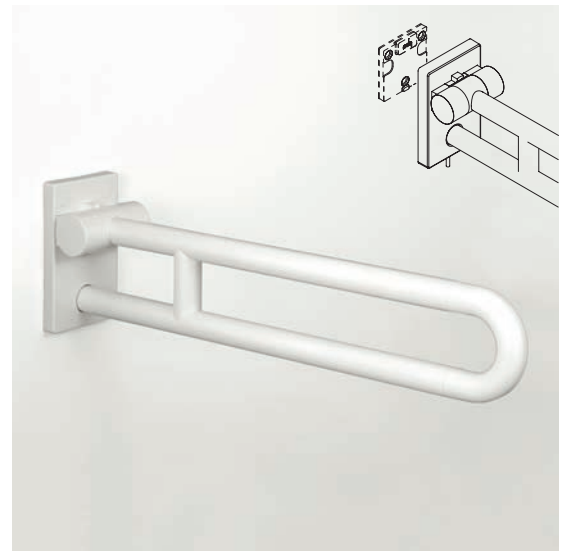

ART. A
 4CN.445.000C .xx 705*



PATENTED

ART. A
 ART.445.000T .75 600*
 ART.445.0000 .75 700*



ART.
 4CN.445.0CPM .00



ART.
 4CN.445.0CCP .xx

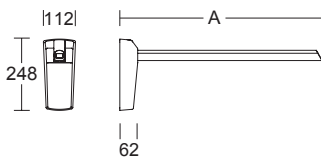

- Sostegno di sicurezza ribaltabile
- Lift-up safety support with friction device
- Barre d'appui relevable
- Stützklappgriff



ALLUMINIO VERNICIATO
 POWDER COATED ALUMINIUM
 ALUMINIUM LAQUE
 BESCHICHTETEM ALUMINIUM

.30	.24	.75
4CA		ART

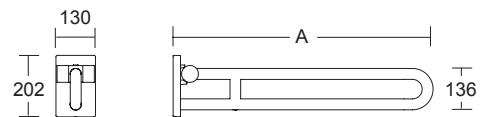

- Sostegno di sicurezza ribaltabile estraibile
- Extractable lift-up safety support
- Barre d'appui relevable extractif
- Stützklappgriff, abnehmbar



NYLON .XX FINISH

.A1	.01	.02	.03	.04	.05	.07	.09	.10	.17



ART.	A	B
4CN.447.00CM .01	400*	415*



ART.	A	B
4CN.447.00CM .17	400*	415*

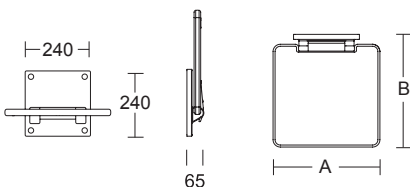

- Seggiolino ribaltabile in nylon con seduta morbida
- Lift-up nylon shower seat with soft seat
- Siège relevable en nylon avec assise souple
- Duschsitz klappbar mit Sitz aus Polyurethan



NYLON	.XX	FINISH
	.01	.17



◆ RIGHT

ART.	◆	A	B
CAP.422.0000 .xx .x		220 (252)*	520 (552)*
CAP.422.9999 .xx .x			



◆ RIGHT

ART.	◆	A	B
ART.422.0000 .75 .x		220 (252)*	520 (552)*
ART.422.9999 .75 .x			

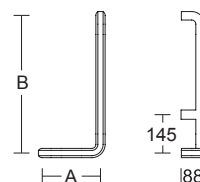

- Sostegno di sicurezza a "L"
- "L"-shaped safety support
- Barre d'appui forme à "L"
- Sicherheitsgriff, L – Form



ALLUMINIO VERNICIATO	.XX	FINISH
POWDER COATED ALUMINIUM	.30	.24
ALUMINIUM LAQUE		
BESCHICHTETEM ALUMINIUM		.75
	CAP	ART



◆ LEFT

ART.	◆	A	B	C
CAP.424.0000 .xx .x		660 (676)*	660 (678)*	820 (852)*
CAP.424.9999 .xx .x	Ⓢ	Ⓢ	Ⓢ	Ⓢ



ART.	A
CAP.440.0000 .xx	370 (400)*
CAP.440.9999 .xx	Ⓢ



◆ LEFT

ART.	◆	A	B	C
ART.424.0000 .75 .x		660 (676)*	660 (678)*	820 (852)*
ART.424.9999 .75 .x	Ⓢ	Ⓢ	Ⓢ	Ⓢ



ART.	A
ART.440.0000 .75	370 (400)*
ART.440.9999 .75	Ⓢ

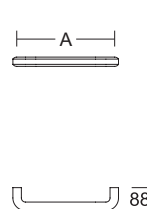
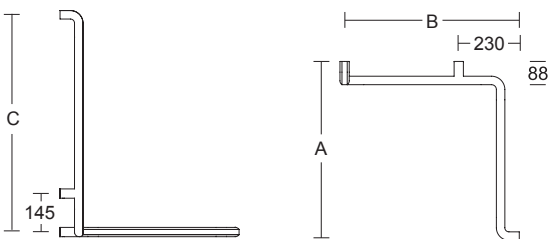

- Sostegno di sicurezza ad angolo con impugnatura verticale
- Corner shower rail with shower head rail
- Barre d'appui à coin avec barre de douche
- Duschhandlauf mit Brausehalterstange



- Sostegno di sicurezza orizzontale
- Horizontal safety support
- Barre d'appui horizontale
- Haltegriff



ALLUMINIO VERNICIATO
POWDER COATED ALUMINIUM
ALUMINIUM LAQUE
BESCHICHTETEM ALUMINIUM

.XX FINISH	.30	.24	.75
CAP	□	■	■
ART	□	■	■

- ◆ .1 DESTRO RIGHT DROITE RECHTS
- .2 SINISTRO LEFT GAUCHE LINKS





ART. A
CAP.487.0000 .xx 570 (600)*
CAP.487.9999 .xx



ART. A B
CAP.487.00RD .xx 140* 93*



ART. A
ART.487.0000 .75 570 (600)*
ART.487.9999 .75



ART. A B
ART.487.00RD .75 140* 93*

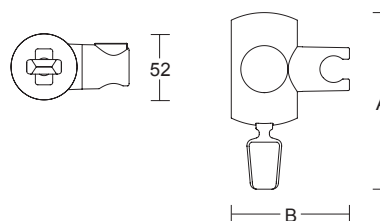
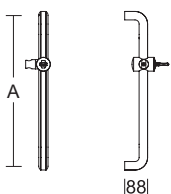

- Sostegno di sicurezza con reggisoffione
- Fixed safety support with shower head holder
- Barre d'appui fixe avec curseur de douche
- Brausehalterstange mit Brausehalter



- Reggisoffione girevole con attacco conico universale a scorrimento
- Rotating Shower head holder with universal sliding tapered connection
- Curseur de douche rabatable avec élément de fixation mobile et conique universel
- Brausehalter, drehbar mit konischer Universaladapter und Höhenverstellung

ALLUMINIO VERNICIATO	.XX	FINISH
POWDER COATED ALUMINIUM	.30	.24
ALUMINIUM LAQUE		.75
BESCHICHTETEM ALUMINIUM		
	CAP	ART



ART.	A	B
CAP.490.0000 .xx	600*	1100*

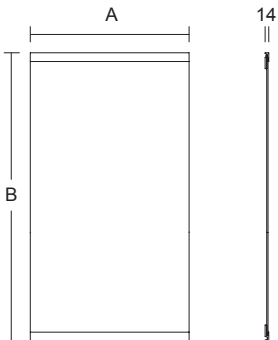

- Specchio fisso
- Fixed mirror
- Miroir fixe
- Wandspiegel

ALLUMINIO VERNICIATO
 POWDER COATED ALUMINIUM
 ALUMINIUM LAQUE
 BESCHICHTETEM ALUMINIUM

.XX FINISH	.30	.24



ART.	A	B	C	α
4CA.471.0000 .00	600*	500*	160*	18°
4CA.471.000Q .00	600*	650*	210*	18°

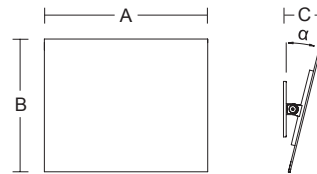

- Specchio orientabile senza cornice
- Adjustable mirror without frame
- Miroir orientable sans cadre
- Kippspiegel ohne Rahmen



ART.	A	B
CAP.562.0000 .xx	Ø 50	76*

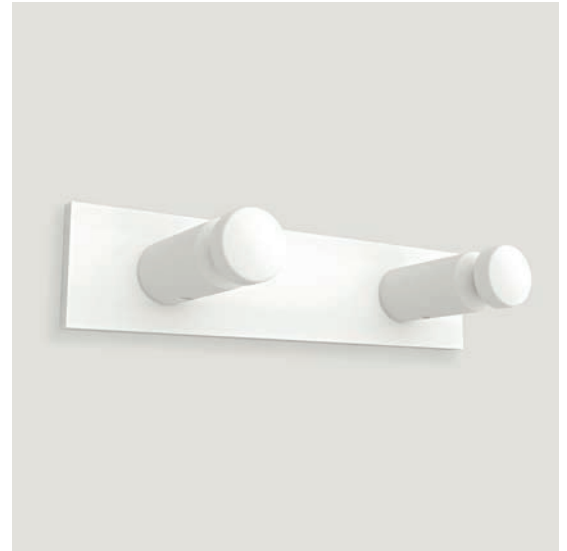

ART.	A	B
CAP.488.0000 .xx	125*	30*



ART.	A	B
ART.562.0000 .75	Ø 50	76*



ART.	A	B
ART.488.0000 .75	125*	30*

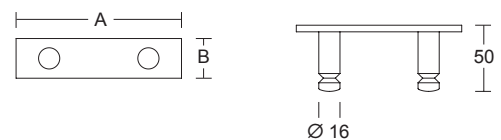
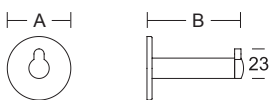

- Appendiabiti fermaporta
- Door-stop cloth hook
- Patère-butoir
- Wandhaken mit Türpufferelement

- Gancio appendiabiti doppio
- Double cloth hook
- Patère double
- Doppelwandhaken

<p>ALLUMINIO VERNICIATO POWDER COATED ALUMINIUM ALUMINIUM LAQUE BESCHICHTETEM ALUMINIUM</p>	<p>.XX FINISH</p> <table border="0"> <tr> <td></td> <td></td> <td></td> </tr> <tr> <td>.30</td> <td>.24</td> <td>.75</td> </tr> <tr> <td colspan="2">CAP</td> <td>ART</td> </tr> </table>				.30	.24	.75	CAP		ART
.30	.24	.75								
CAP		ART								





ART.	A	B	C
CAP.483.00PM .xx	150*	110*	44*



ART.	A	B	C
CAP.483.00DM .xx	150*	110*	136*



ART.	A	B	C
ART.483.00PM .75	150*	110*	44*

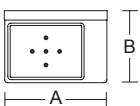
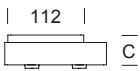

- Mensola con portasapone
- Shelf with soap dish
- Tablette avec porte savon
- Seifenablage

ALLUMINIO VERNICIATO
POWDER COATED ALUMINIUM
ALUMINIUM LAQUE
BESCHICHTETEM ALUMINIUM

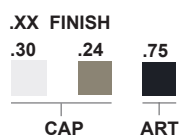

ART.	A	B	C
ART.483.00DM .75	150*	110*	136*

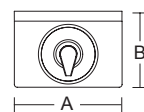
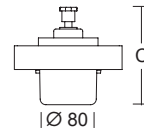

- Mensola con dispenser
- Shelf with soap dispenser
- Tablette avec distributeur de savon
- Seifenspender



ART.	A	B	C
CAP.483.0IBM .xx	150*	110*	130*



ART.	A	B	C
CAP.481.00BA .xx	150*	110	108



ART.	A	B	C
ART.483.0IBM .75	150*	110*	130*



ART.	A	B	C
ART.481.00BA .75	150*	110	108

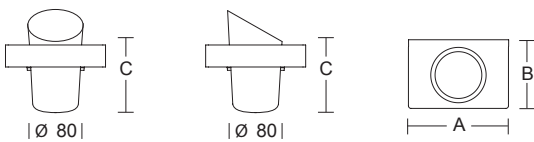

- Mensola con bicchiere conico
- Shelf with conical tumbler
- Tablette avec gobelet conique
- Becherhalter mit Becher, konischer Öffnung

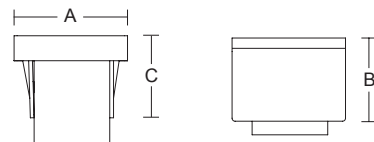

- Portarotolo a muro
- Wall toilet roll holder
- Porte-papier murale
- Papierrollenhalter

ALLUMINIO VERNICIATO
POWDER COATED ALUMINIUM
ALUMINIUM LAQUE
BESCHICHTETEM ALUMINIUM

.XX FINISH	.30	.24	.75
CAP			
ART			



ART.	A	B	C
CAP.486.0000 .xx	150*	110*	380*



ART.	A	B	C
CAP.498.0000 .30	120	265*	320*



ART.	A	B	C
ART.486.0000 .75	150*	110*	380*

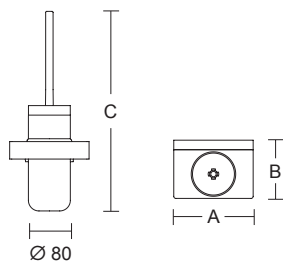

- Portascopino in nylon con mensola in alluminio
- Nylon toilet brush set with aluminium bathroom shelf
- Ensemble brosse WC en nylon avec tablette en aluminium
- Toilettenbürstengarnitur aus Nylon mit Halterung aus Aluminium

ALLUMINIO VERNICIATO	.XX FINISH		
POWDER COATED ALUMINIUM	.30	.24	.75
ALUMINIUM LAQUE			
BESCHICHTETEM ALUMINIUM			
	CAP		ART

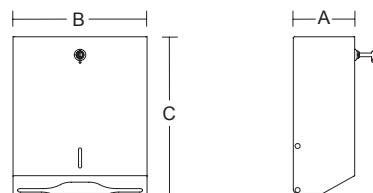

- Portasalviette verniciato bianco
- White varnished paper towel dispenser
- Distributeur d'essuie-mains papier en coloris laqué blanc
- Papierhandtuchspender, weiß lackiert

ALLUMINIO VERNICIATO	.XX FINISH
POWDER COATED ALUMINIUM	.30
ALUMINIUM LAQUE	
BESCHICHTETEM ALUMINIUM	
	CAP



◆ RIGHT

ART.	◆	A	B
4CS.422.0000 . xx . x		220 (300)*	520 (600)*
4CS.422.9999 . xx . x.	Ⓒ	Ⓒ	Ⓒ



ART.	A
4CS487.0000 . xx	570 (650)*
4CS.487.9999 . xx	Ⓒ



ART.	A
4CS.440.0000 . xx	370 (450)*
4CS.440.9999 . xx	Ⓒ



ART.	A	B
4CS.487.00RD .17	140*	93*

- Sostegno di sicurezza
- Safety support
- Barre d'appui
- Sicherheitsgriff



- Sostegno di sicurezza con reggisoffione
- Fixed safety support with shower head holder
- Barre d'appui fixe avec curseur de douchette
- Brausehalterstange mit Brausehalter



ACCIAIO INOX
STAINLESS STEEL
ACIER INOX
EDELSTAHL ROSTFREI

.XX FINISH

.44	.43
SATIN	BRIGHT

- ◆
- .1 DESTRO RIGHT DROITE RECHTS
- .2 SINISTRO LEFT GAUCHE LINKS



ART. A
4CS.445.0000 .xx 700*



ART. A B C
4CS.490.000R .xx 600* 500 550*



ART. A B
4CS.447.000B .xx 380* 390*



ART. A B C
4CS.011.0000 .xx 192* 192* 290* lt. 8
4CS.012.0000 .xx 192* 192* 430* tl. 12

- Sostegno di sicurezza e seggiolino ribaltabili
- Lift-up safety support and shower seat
- Barre d'appui et siège relevables
- Stützklappgriff und Klappsitz



- Specchio e cestino
- Mirror and waste bin
- Miroir et poubelle
- Spiegel und Abfallbehälter

ACCIAIO INOX
STAINLESS STEEL
ACIER INOX
EDELSTAHL ROSTFREI

.XX FINISH
.44 SATIN
.43 BRIGHT



ART.	A	B
4CS.481.000Q .44	179*	111*



ART.	A	B
4CS.486.000H .xx	510*	Ø 80



ART.	A	B
4CS.481.0QRL .44	279*	111*



ART.	A	B
4CS.488.000C .xx	Ø 50	63*

- Portarotolo e portarotolo di riserva
- Toilet roll holder and spare toilet roll holder
- Porte-papier et porte-papier de réserve
- Papierrollenhalter und Reservepapierhalter

- Portascopino e gancio
- Toilet brush set and cloth hook
- Ensemble brosse WC et patère
- WC-Bürstengarntur und Wandhaken

ACCIAIO INOX
STAINLESS STEEL
ACIER INOX
EDELSTAHL ROSTFREI

.XX FINISH
.44 .43
SATIN BRIGHT



ART.	A	B
4CS.488.000D .xx	Ø 50	40*



ART.	A	B
4CS.488.0000 .xx	Ø 50	40*

- Gancio appendiabiti
- Cloth hook
- Patère
- Wandhaken

ACCIAIO INOX
STAINLESS STEEL
ACIER INOX
EDELSTAHL ROSTFREI

.XX FINISH

.44	.43
	
SATIN	BRIGHT



ART.	A	B
4CS.426.0000 .xx	500*	106



ART.	A	B
4CS.489.0000 .xx	400 (450)*	90*
4CS.489.000A .xx	500 (550)*	90*
4CS.489.000B .xx	600 (650)*	90*

- Portasciugamani
- Towel holder
- Porte-serviettes
- Handtuchhalter

TERAPIA DEL COLORE



COLOR THERAPY



THÉRAPIE DE LA COULEUR



FARB THERAPIE

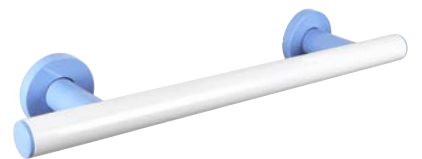

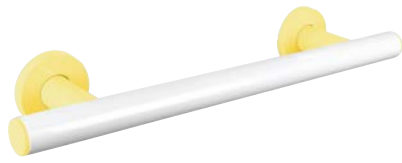

COVER PHOTOS:
GABRIELE BASILICO
pba S.p.A All right reserved

PRINTED IN ITALY

pba S.p.A. Via Enrico Fermi, 1 I-36056 Tezze sul Brenta (Vicenza) Italia
Tel. +39 0424 5451 Fax +39 0424 545222 info@pba.it www.pba.it

pba Deutschland GmbH Zum Schürmannsgraben 24 D-47441 Moers Deutschland
Tel. +49 2841 99890 0 Fax +49 2841 99890 20 info@de.pba.it www.pba.it

pba USA, Inc. 68 34th Street Suite C405 Unit 20 Industry City Brooklyn NYC
NY 11232 United States Tel. +1 212 255 4605 Fax +1 646 558 0335 office@pba-usa.us www.pba.it