

REGUITTI

Maniglie & Accessori
Handles & Accessories

IL CATALOGO
THE CATALOGUE

15



Sommario capitoli *_ Index chapters*

INFORMAZIONI TECNICHE <i>_ TECHNICAL INFO</i>	da pag.	8
Qualità <i>_ Quality</i>	da pag.	8
Servizi <i>_ Service</i>	da pag.	26
Specifiche Commerciali <i>_ Commercial Specifications</i>	da pag.	30
Antigerm <i>_ Antigerm</i>	da pag.	38
VINTAGE COLLECTION <i>_ VINTAGE COLLECTION</i>	da pag.	44
● Antico <i>_ Antique</i>	da pag.	45
● Argento Vecchio <i>_ Old Silver</i>	da pag.	71
● Ruggine <i>_ Oxid</i>	da pag.	91
● Rustico <i>_ Rustik brass</i>	da pag.	103
● Bronzo 800 <i>_ Mat scratched bronzed brass</i>	da pag.	113
● Ramato Vintage <i>_ Vintage Coppered</i>	da pag.	129
● Lucido Naturale <i>_ Natural brass</i>	da pag.	133
● Nero California <i>_ Black California</i>	da pag.	137
ELEMENTIA <i>_ ELEMENTIA</i>	da pag.	141
FLAT LINE <i>_ FLAT LINE</i>	da pag.	148
199 UNIQA <i>_ 199 UNIQA</i>	da pag.	162
MINIMAL LINE <i>_ MINIMAL LINE</i>	da pag.	164
SOLUZIONI PER PORTE <i>_ SOLUTIONS FOR DOORS</i>	da pag.	172
Nottolini WC <i>_ WC Bathroom sets</i>	da pag.	172
Cappucci copricerniere <i>_ Bolts, hinges and cover hinges</i>	da pag.	184
Placche per ristrutturazioni <i>_ Plates for renovations</i>	da pag.	193
Speciali per profili stretti <i>_ For special narrow profiles</i>	da pag.	196
Speciali per porte Rei <i>_ For special fire rated doors</i>	da pag.	197
SOLUZIONI PER FINESTRE E PORTE FINESTRE	da pag.	198
<i>SOLUTIONS FOR WINDOWS AND BALCONY DOORS</i>		
DK024 Montaggio rapido <i>_ DK 024 Fast mounting</i>	da pag.	198
Securblock <i>_ Securblock</i>	da pag.	200
DK con chiave e cilindro <i>_ Window handle with cylinder and key</i>	da pag.	204
Accessori per Dreh Kipp <i>_ Dreh Kipp components</i>	da pag.	208
Sistemi DK-TK-MK <i>_ DK-TK-MK Systems</i>	da pag.	211
Placche per ristrutturazioni <i>_ Plates for renovations</i>	da pag.	216
Soluzioni per aste esterne <i>_ Solutions for outside rods</i>	da pag.	219

MANIGLIE PER PORTE INTERNE E FINESTRE <i>LEVER HANDLES FOR INTERIOR DOORS AND WINDOWS</i>	da pag. 223
● Porcellana _ <i>Porcelain</i>	da pag. 447
● Acciaio Inox _ <i>Stainless steel</i>	da pag. 467
● Alluminio _ <i>Aluminium</i>	da pag. 483
PORTE D'ENTRATA _ ENTRANCE DOORS	da pag. 499
● Maniglioni _ <i>Pull Handles</i>	da pag. 500
● Battenti _ <i>Door Knocker</i>	da pag. 545
● Pomoli _ <i>Door Knobs</i>	da pag. 556
PORTE E FINESTRE SCORREVOLI <i>SLIDING DOOR AND WINDOW HANDLES</i>	da pag. 607
Kit e placche incasso _ <i>Sliding doors kits and flush pull plates</i>	da pag. 618
Maniglioni per alzanti scorrevoli _ <i>Pull Handles for lift and slide systems</i> ...	da pag. 711
PORTE HOTEL _ HOTEL DOORS	da pag. 739
SICUREZZA E PORTE BLINDATE _ SAFETY AND ARMoured DOORS	da pag. 757
COMPLEMENTI D'ARREDO _ ASSORTED ACCESSORIES	da pag. 785
SOLUZIONI TECNICHE E COMPONENTI <i>TECHNICAL SOLUTIONS AND COMPONENTS</i>	da pag. 865
● Rosette _ <i>Roses</i>	da pag. 874
● Bocchette _ <i>Key rose</i>	da pag. 914
● Placche per porte _ <i>Plates for doors</i>	da pag. 944
● Placche per finestre _ <i>Plates for windows</i>	da pag. 955
ACCESSORI TECNICI _ TECHNICAL COMPONENTS	da pag. 963
ARTICOLI DA RICAMBIO _ ENDING PRODUCTION ITEMS	da pag. 989
ESPOSITORI E CONFEZIONI _ DISPLAY & PACKAGING	da pag. 1005
TABELLA FINITURE _ FINISHES TABLE	da pag. 1014
INDICE PER CODICI _ CODES INDEX	da pag. 1024
CONDIZIONI DI VENDITA _ TERMS AND SALES CONDITION	da pag. 1038

Alba
art. B25
Pag. 490



Alexia
art. 23
Pag. 489



Alexis
art. 234
Pag. 382



Alfa
art. 21
Pag. 486



Alice
art. 20
Pag. 484



Alisé
art. 171
Pag. 330



Alisé/Inox
art. 171
Pag. 468



Alma
art. 185
Pag. 348



Altea
art. 22
Pag. 488



Ambra
art. 252
Pag. 388



Appia
art. 182
Pag. 341



Apri
art. 121
Pag. 264



Arca
art. 134
Pag. 296



Arja
art. 197
Pag. 364



Asola
art. 122
Pag. 266



Astra
art. 184
Pag. 346



Auxilium
art. 188
Pag. 350



B-Arte
art. 426
Pag. 417



B-Line
art. 195
Pag. 360



B-Mini
art. 143
Pag. 313



B-Mini
art. 143
Pag. 314



B-Mini26
art. B26
Pag. 436



B-Strass
art. 428
Pag. 420



Baltic
art. 73
Pag. 250



Bergen
art. 94
Pag. 255



Betty
art. 183
Pag. 342



Bionic
art. 704
Pag. 477



Brixton
art. 342
Pag. 400



Brixton B
art. 343
Pag. 401



C-Plus
art. 150
Pag. 324



Camilla
art. 178
Pag. 339



Capri
art. 80
Pag. 253



Cassia
art. 179
Pag. 340



Charme
art. 900
Pag. 430



Chris
art. 79
Pag. 252



Cigno
art. 271
Pag. 389



Cinzia
art. 69
Pag. 448



Clara
art. 238
Pag. 385



Class
art. 192
Pag. 356



Claudia
art. 101

Pag. 258



Cleo
art. 347

Pag. 402



Collo Basso
art. 26

Pag. 226



Comby
art. 288

Pag. 396



Dafne
art. 123

Pag. 267



Dania
art. 159

Pag. 322



Desy
art. 137

Pag. 302



Edna
art. 261

Pag. 446



Elba
art. T88

Pag. 444



Elena
art. 30

Pag. 228



Elle
art. 702

Pag. 472



Entry
art. 348

Pag. 404



Epoca
art. 800

Pag. 428



Eva

art. 275

Pag. 395



Fede

art. 151

Pag. 320



Flash

art. 131

Pag. 290



Florida

art. 16

Pag. 224



Futura

art. 164

Pag. 325



Gaia

art. 226

Pag. 376



Gentile

art. 382

Pag. 408



Giada

art. 251

Pag. 387



Ginevra

art. 40

Pag. 236



Glory

art. 224

Pag. 373



Golf

art. J15

Pag. 432



Grazia

art. 70

Pag. 248



Gretel

art. 174

Pag. 461



Hansel

art. 172

Pag. 460



Heidi

art. 232

Pag. 380



Inna

art. 145

Pag. 318



Isolde

art. 230

Pag. 379



Ixia

art. J40

Pag. 434



Java

art. 701

Pag. 470



Jessica

art. 233

Pag. 381



Jet

art. 705

Pag. 478



L-Plus

art. 140

Pag. 306



Lapia

art. 223

Pag. 372



Laser

art. 130

Pag. 288



Lira

art. 237

Pag. 384



Lory

art. 127

Pag. 278



Lucca

art. T42

Pag. 442



Mary

art. 46

Pag. 239



Mayfair

art. 370

Pag. 406



Mignon

art. T33

Pag. 438



Miriam

art. 225

Pag. 374



Moira

art. 66

Pag. 244



Monia

art. 37

Pag. 234



Nadia

art. 61

Pag. 242



Nordica

art. 93

Pag. 254



Norma

art. 128

Pag. 280



Olivia

art. 63

Pag. 243



Open

art. 139

Pag. 304



Ovalino

art. 191

Pag. 354



Phedra

art. 133

Pag. 292



Pisa

art. 67

Pag. 246



Praga

art. 166

Pag. 326



Public

art. 175

Pag. 338



Q-10

art. 119

Pag. 262



Q-Arte

art. 124

Pag. 268



Q-Arte D2

art. 124-D2

Pag. 272



Q-Arte Riga

art. 124-Riga

Pag. 271



Q-Arte Segmenti

art. 124-Seg.

Pag. 270



Q-Arte SW

art. 124SW

Pag. 273



Q-Elle

art. 702

Pag. 476



Q-Inox

art. Q19

Pag. 479



Q-Insert

art. 425

Pag. 416



Q-Line

art. 194

Pag. 358



Q-Mini

art. 142

Pag. 310



Q-Mini

art. 142

Pag. 312



Q-Mini26

art. Q26

Pag. 437



Q-Plus

art. 423

Pag. 412



Q-Plus SW

art. 423-SW

Pag. 414



Q-Star

art. 429

Pag. 422



Q-Star SW

art. 429-SW

Pag. 424



Q-Strass

art. 427

Pag. 418



Q-Ubik

art. 422

Pag. 410



Quark

art. 144

Pag. 316



Rita

art. 43

Pag. 238



Rombo

art. 126

Pag. 276



Romea
art. 189
Pag. 352



Round
art. 136
Pag. 300



Sabina
art. 31
Pag. 230



Sandra
art. 168
Pag. 458



Sasha
art. 173
Pag. 334



Scarabeo
art. 104
Pag. 260



Shut
art. 196
Pag. 362



Slim
art. 274
Pag. 394



Soffio
art. 272
Pag. 390



Spring
art. 141
Pag. 308



Stylus
art. 229
Pag. 378



Tosca
art. 49
Pag. 240



Triade
art. 125
Pag. 274



Triangolo
art. 273
Pag. 392



Tris
art. 228
Pag. 377



Tuscania
art. T36
Pag. 440



Uniqua
art. 199
Pag. 366



Uovo
art. 97
Pag. 256



Uovo
art. 97 All.
Pag. 491



Usa
art. 703
Pag. 474



Vienna
art. 167
Pag. 328



Vilma
art. 236
Pag. 383



Waltham
art. 336
Pag. 397



Winchester
art. 337
Pag. 398



Wing
art. 129
Pag. 282



XL.B-Arte
art. 434
Pag. 426



XLI-Plus
art. 250
Pag. 386



X.LQ-Arte
art. 432
Pag. 425



X.LQ-Star
art. 436
Pag. 427



Certificazione EN1906

Certification EN1906

Specifiche delle valutazioni ottenute

Specifications assessments obtained

Reguitti Spa ha ottenuto le certificazioni attraverso la committenza della propria consociata Jatec GmbH.
Reguitti Spa obtained the certifications through the commissioning of its subsidiary Jatec GmbH.

DURABILITÀ - Durability

- 6** Uso medio 100.000 cicli
Medium use 100.000 cycles
- 7** Uso elevato 200.000 cicli
Large use 200.000 cycle

SICUREZZA - Safety

- 0** Per uso normale
Normal use
- 1** Per uso con requisiti di sicurezza
High strength fixings

RESISTENZA AL FUOCO - Fire resistance

- 0** Non adatta per porte tagliafuoco o antifumo
Not suitable for fire/smoke resistant door assemblies
- 1** Adatta per porte tagliafuoco ed antifumo
Suitable for fire/smoke resistant door assemblies

TIPO DI AZIONAMENTO - Type of operation

- A** Con molla
Spring assisted furniture
- B** Con precarico a molla
Spring loaded furniture
- U** Senza molla
Unsprung furniture

3 - 4 7 - / - 0 0 4 0 A

SPESORE DELLA PORTA - Test door mass

Non utilizzata
No Requirement

SICUREZZA CONTRO LO SCASSO - Security

- 0** Nessuna resistenza allo scasso
No burglary resistance
- 1** Ridotta resistenza allo scasso
Mild burglary resistance
- 2** Media resistenza allo scasso
Moderate burglary resistance
- 3** Alta resistenza allo scasso
High burglary resistance
- 4** Resistenza estremamente alta allo scasso
Extremely high burglary resistance

CATEGORIA DI UTILIZZO - Category of use

- 1** Utilizzo leggero
Light duty
- 2** Utilizzo medio
Medium duty
- 3** Utilizzo pesante ad elevata frequenza
Heavy duty
- 4** Utilizzo con forza
Severe duty

Reguitti ha ottenuto il grado 3 per il sistema R16 e il grado 4 per il sistema 38 e sistema R1
Reguitti obtained grade 3 for system R16 and grade 4 for system 38 and system R1

RESISTENZA ALLA CORROSIONE - Corrosion resistance

- 0** Nessuna resistenza definita alla corrosione (nessun test)
No defined corrosion resistance (no test)
- 1** Ridotta resistenza alla corrosione (test nebbia salina 24h)
Low corrosion resistance (salt spray test 24h)
- 2** Media resistenza alla corrosione (test nebbia salina 48h)
Mid corrosion resistance (salt spray test 48h)
- 3** Alta resistenza alla corrosione (test nebbia salina 96h)
High corrosion resistance (salt spray test 96h)
- 4** Resistenza molto alta alla corrosione (test nebbia salina 240h)
Very high corrosion resistance (salt spray test 240h)
- 5** Resistenza estremamente alta alla corrosione (test nebbia salina 480h)
Extremely high corrosion resistance (salt spray test 480h)

Certificazione EN1906_Certification EN 1906

Standardizzazione europea per maniglie e pomoli_European standardisation for door handle hardware

Sistema R16-T_System R16



Nachweis
Türdrücker und Türknaufe gemäß EN 1906 : 2010

Prüfbericht
Nr. 12-000531-PR03
(PD-G03-03-de-01)

Auftraggeber JATEC GmbH
Maybachstrasse 4
63322 Rödermark
Deutschland

Produkt Türdrückergarnitur / Drücker / Drücker

Bezeichnung System R16 T / 47WD16-AJ15MRD16

Leistungselemente / Produktmerkmale Material Crücker: Zeimak,
Lagerung: Dreiflur-Lager,
Drückervertiefung: 8,0 mm.

Montage Material Drückervertiefung: Stahl, verzinkt
Gemäß der Montageanleitung des
Beschlagsherstellers.

Besondereheiten keine

Ergebnis
Klassifizierung gemäß EN 1906 : 2010

Benutzerkategorie	Dauerhaftigkeit	Formstabilität	Feuerbeständigkeit	Sicherheit	Korrosionsbeständigkeit	Einstochersicherheit	Ausführung
3	7	+	0	0	4	0	A

Drückervertiefung: 8,0 mm, Material: Stahl, Lagerung: Dreiflur-Lager

ift Rosenheim
29. August 2012

Andreas Matzki, Dipl.-Ing. (FH)
 Produktentwickler
 Bauteile

Pascal Geiger, Dipl.-Ing. (FH)
 Produktingenieur
 Bauteile

Grundlagen
EN 1906: 2010
Prüfnormen:
EN 1906: 2010

Entsprechende nationale Forderungen (z.B. DIN EN) Darstellung



Verwechslungsgefahr
Dieser Prüfbericht dient nur Nachweise der Anforderungen von Tischschloß und Türschloß EN 1906: 2010.

Gültigkeit
Das gezeichnete Datum stellt den Gültigkeitsbeginn dar. Die Gültigkeit des Prüfberichts ist auf den jeweils letzten beschriebenen Prüfbericht begrenzt. Die Gültigkeitsdauer ist so lange das Produkt unverändert ist und die o.g. Grundlagen nicht geändert wurden. Das Ergebnis kann unter Berücksichtigung möglicher Änderungen der Produktdaten in Eigenverantwortung des Herstellers überholt werden. Diese Prüfung/Demonstration ermöglicht keine Aussagen über weitere funktionale- und qualitätsbestimmende Eigenschaften über die besagten Parameter. Insbesondere sind Abhängigkeiten zwischen den Prüfparametern nicht berücksichtigt.
Verwechslungsgefahr
Es gilt das Merkmal "Werbung mit dem Produktanforderungen". Das Produktbild kann die Ausführung veranschaulichen.
Der Nachweis umfasst insgesamt 10 Seiten.

IFT Rosenheim GmbH
Georgstraße 1
D-84031 Rosenheim
Tel. +49 (0)89 3091-100
Fax +49 (0)89 3091-100
www.ift-rosenheim.de

IFT R16-T
D-84031 Rosenheim
Tel. +49 (0)89 3091-100
Fax +49 (0)89 3091-100
www.ift-rosenheim.de

IFT R16-T
D-84031 Rosenheim
Tel. +49 (0)89 3091-100
Fax +49 (0)89 3091-100
www.ift-rosenheim.de

DIN EN1906

Ai fini della standardizzazione europea è stata introdotta la norma DIN EN1906 che stabilisce requisiti e metodi di prova per maniglie e pomoli. La norma DIN EN1906 definisce solo i parametri di prestazione (le dimensioni delle guarniture non sono state prese in considerazione). Inoltre introduce un sistema di valutazione con un codice che permette di confrontare i vari prodotti. **Per il sistema R16-T Regutti ha ottenuto il Grado 3** della categoria di utilizzo, che denota ottima qualità e resistenza.

For the purposes of European standardisation the DIN EN1906 has been introduced to specify requirements and test methods for door handles and door knobs. The DIN EN1906 defines only performance parameters (hardware dimensions have not been taken into account). It introduces a classification code system, allowing products to be compared. **Regutti obtained for the system R16-T the Grade 3** of the category of use that indicates excellent quality and resistance.

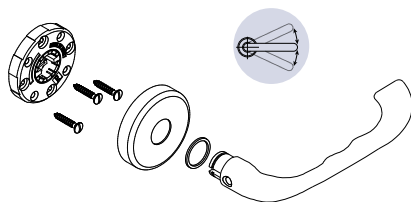

Certificazione EN1906_Certification EN 1906

Standardizzazione europea per maniglie e pomoli_European standardisation for door handle hardware

Sistema R38_System R38



Nachweis
Türdrücker und Türkäufe gemäß EN 1906 : 2010

Prüfbericht
Nr. 12-000531-PR04
(PB-G03-03-de-01)

Auftraggeber
JATEC GmbH
Maybachstrasse 4
83322 Rödernmark
Deutschland

Produkt
Türdrückergarnitur / Drücker / Drücker

Bezeichnung
System R 38 / 180/D38-A188MRD38

Leistungselemente
Produktedetails
Material Drücker: Messing, Vollmaterial,
Lagerung: Drehbar-Fest,
Drückerhöhe: 8,0 mm,
Material Drückerschaft: Stahl, verzinkt

Montage
Gemäß der Montageanleitung des
Beschiagsherstellers.

Besonderheiten
keine

Ergebnis
Klassifizierung gemäß EN 1906 : 2010

Besuchers- kategorie	Einbruch- Kategorie	Türschloss	Flügelstabilität	Sicherheit	Korrosionsbeständigkeit	Flamm- sicherheit	Ausführung
4	7	-L	0	0	4	0	A

Widerstandswert: 8,0 mm, Material: Stahl, Lagerung: Drehbar-Fest

ift Rosenheim
29. August 2012

Andreas Malsch, Dipl.-Ing. (FH)
Prüfingenieur
Bauteile

Pascal Geiger, Dipl.-Ing. (FH)
Produktionsingenieur
Bauteile

Gründlagen
EN 1906 : 2010
Prüflokale
EN 1906 : 2010

Entsprechende nationale Festlegungen (z.B. DIN EN) Darstellung

Verwendungshinweise
Dieser Prüfbericht dient zum Nachweis der Anforderungen an Türdrücker und Türkäufe nach EN 1906 : 2010.

Gültigkeit
Die gemessenen Daten und Dimensionen stimmen mit den spezifizierten Anforderungen überein. Die Konformität gilt solange das Produkt unverändert ist und die v.g. Grundlagen nicht leicht geändert haben. Die Ergebnisse haben unter Beachtung entsprechender Freidragungen der Prüfdimensionen Eigenverantwortung der Hersteller. Überprüfen werden. Diese Prüfungsleistung ermöglicht bei der Auslegung über weitere Leistungs- und qualitätsbestimmende Eigenschaften der vorliegenden Konstruktion, insbesondere Widerstände und Alterungserscheinungen, keine Aussagen.

Verantwortungshinweise
Es gilt das Stichtagdatum "Werbung mit Ift Prüfingenieurleistungen". Das Datum kann als Festlegung verwendet werden. Der Hersteller ist selbst verantwortlich für seine Produkte.

ift Rosenheim (GmbH)
Dienstadtstr. 1
D-83054 Rosenheim
Tel. +49 (0)89 3100-100
Fax +49 (0)89 3100-100
www.ift-rosenheim.de

**ift AG (Köln) Registreert
Köln, Germany, since 1978**
Königsplatz Rosenheim
D-83054
Tel. +49 89 3100 100
Fax +49 89 3100 100

**International Institute
for Testing and Research, gmbh**
Königsplatz Rosenheim
D-83054
Tel. +49 89 3100 100
Fax +49 89 3100 100

DIN EN1906

Ai fini della standardizzazione europea è stata introdotta la norma DIN EN1906 che stabilisce requisiti e metodi di prova per maniglie e pomoli. La norma DIN EN1906 definisce solo i parametri di prestazione (le dimensioni delle garniture non sono state prese in considerazione). Inoltre introduce un sistema di classificazione con un codice che permette di confrontare i vari prodotti. **Per il sistema R38 Reguitti ha ottenuto il Grado 4** della categoria di utilizzo, che denota massima qualità e resistenza.

For the purposes of European standardisation the DIN EN1906 has been introduced to specify requirements and test methods for door handles and door knobs. The DIN EN1906 defines only performance parameters (hardware dimensions have not been taken into account). It introduces a classification code system, allowing products to be compared. **Reguitti obtained for the system R38 the Grade 4** of the category of use that indicates best quality and resistance.

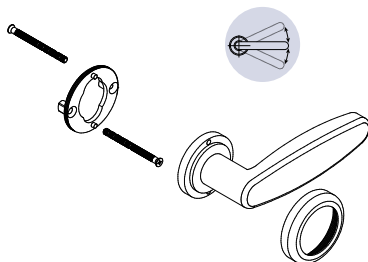

Certificazione EN1906_Certification EN 1906

Standardizzazione europea per maniglie e pomoli_European standardisation for door handle hardware

Sistema R1_System R1



Nachweis
Türdrücker und Türkäufe gemäß EN 1906 : 2010

Prüfbericht
Nr. 12-000531-PR02
(PB-G03-03-de-01)

Auftraggeber
JATEC GmbH
Maybachstrasse 4
63322 Rödermark
Deutschland

Produkt
Türdrückergarnitur / Drücker / Drücker

Bezeichnung
System R1 / 800/D06-A800MRD06

Leistungsrelevante Produktdetails
Material Drücker: Messing,
Lagerung: Drehbar-Fest,
Drückervierkant: 8,0 mm,
Material Drückervierkant: Stahl, verzinkt
Gemäß der Montageanleitung des
Beschlagsherstellers.

Besonderheiten
keine

Grundlagen
EN 1906 : 2010
Prüfnormen:
EN 1906 : 2010

Entsprechende nationale Fassungen (z.B. DIN EN)
Darstellung



Verwendungshinweise
Dieser Prüfbericht dient zum Nachweis der Anforderungen von Türdrückern und Türkäufen EN 1906 : 2010.

Ergebnis
Klassifizierung gemäß EN 1906 : 2010

Benutzerkategorie	Dauerhaltbarkeit	Türmasse	Feuerbeständigkeit	Sicherheit	Korrosionsbeständigkeit	Einbruchsicherheit	Ausführung
4	7	-/-	0	0	4	0	A

Drückervierkant: 8,0 mm, Material: Stahl, Lagerung: Drehbar-Fest

ift Rosenheim
29. August 2012

Andreas Matschi, Dipl.-Ing. (FH)
Prüfingenieur
Bauteile

Pascal Geiger, Dipl.-Ing. (FH)
Produktionsingenieur
Bauteile

Gültigkeit
Die genannten Daten und Einzelergebnisse beziehen sich ausschließlich auf den geprüften/beschriebenen Probekörper. Die Klassifizierung gilt so lange das Produkt unverändert ist und die o.g. Grundlagen sich nicht geändert haben. Das Ergebnis kann unter Beschlingung entsprechender Festlegungen der Produzenten in Eigenverantwortung des Herstellers übertragen werden. Diese Prüfung/Bewertung ermöglicht keine Aussage über weitere leistungs- und qualitätsbestimmende Eigenschaften der vorliegenden Konstruktion, insbesondere Witterungs- und Alterungseinflüsse wurden nicht berücksichtigt.

Veröffentlichungshinweise
Es gilt das iB-Merkblatt "Werbung mit iB-Prüfdokumentationen". Das Deckblatt kann als Kurzfassung verwendet werden.
Der Nachweis umfasst insgesamt 20 Seiten.

Verfahren 546466 01/08/2011

 ift Rosenheim GmbH
Geschäftsführer:
Dipl.-Ing. (FH) Ulrich Sieberath
Dr. Jochen Peitz

Theodor-Gottl-Str. 7 - 9
D-89026 Rosenheim
Tel. +49 (0)8031(261-1)
Fax +49 (0)8031(261-380)
www.ift-rosenheim.de

Str. 83026 Rosenheim
AG Traunreut, HRB 14763
Sparkasse Rosenheim
Kto. 3827
BLZ 711 500 00

Notified Body No. 0757
Anerkanntes PUZ-GarB, BAY 18
www.bayern.de
089 2300-1000
089 2300-1001
089 2300-1002

DIN EN1906

Ai fini della standardizzazione europea è stata introdotta la norma DIN EN1906 che stabilisce requisiti e metodi di prova per maniglie e pomoli. La norma DIN EN1906 definisce solo i parametri di prestazione (le dimensioni delle garniture non sono state prese in considerazione). Inoltre introduce un sistema di classificazione con un codice che permette di confrontare i vari prodotti. **Per il sistema R1 Regutti ha ottenuto il Grado 4** della categoria di utilizzo, che denota massima qualità e resistenza.

For the purposes of European standardisation the DIN EN1906 has been introduced to specify requirements and test methods for door handles and door knobs. The DIN EN1906 defines only performance parameters (hardware dimensions have not been taken into account). It introduces a classification code system, allowing products to be compared. **Regutti obtained for the system R1 the Grade 4** of the category of use that indicates best quality and resistance.

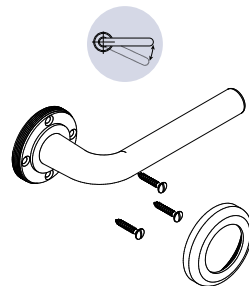

Certificazione EN13126-3 : 2011

Certification EN13126-3 : 2011

Specifiche delle valutazioni ottenute

Specifications assessments obtained

Reguitti Spa ha ottenuto la certificazione attraverso la committenza della propria consociata Jatec GmbH.
Reguitti Spa obtained the certification through the commissioning of its subsidiary Jatec GmbH.

DURABILITÀ - Durability

3/90	10.000 Cicli di utilizzo (rotazione)
3/90	10.000 Turn-Only cycles
4/90	15.000 Cicli di utilizzo (rotazione)
4/90	15.000 Turn-Only cycles
5/90	25.000 Cicli di utilizzo (rotazione)
5/90	25.000 Turn-Only cycles
3/180	10.000 Cicli di utilizzo (rotazione e ribaltamento)
3/180	10.000 Tilt and Turn cycles
4/180	15.000 Cicli di utilizzo (rotazione e ribaltamento)
4/180	15.000 Tilt and Turn cycles
5/180	25.000 Cicli di utilizzo (rotazione e ribaltamento)
5/180	25.000 Tilt and Turn cycles

APPLICAZIONE - Application

Parte applicata di questa norma europea: Classe 3
Applied Part of this European Standard: Class 3

N1 - Martellina senza funzione di arresto
N1 - Martellina window handle without stop function

N2 - Cremonese senza funzione di arresto
N2 - Cremonese window handle without stop function

C1 - Martellina con funzione di arresto
C1 - Martellina window handle with stop function

C2 - Cremonese con funzione di arresto
C2 - Cremonese window handle with stop function

RESISTENZA AL FUOCO - Fire resistance

0 Non adatta per porte tagliafuoco o antifumo
Not suitable for fire/smoke resistant door assemblies

1 Adatta per porte tagliafuoco ed antifumo
Suitable for fire/smoke resistant door assemblies

ENTITÀ VERIFICA - Size limitations

Nessun requisito per l'entità verifica della finestra
No Requirement

2	5/180	- / -	0	1	2	0	3/C1	- / -
---	-------	-------	---	---	---	---	------	-------

MASSA - Mass

Non utilizzata
No Requirement

SICUREZZA - Safety

0 Per uso normale
Normal use

1 Per uso con requisiti di sicurezza
High strength fixings

SICUREZZA CONTRO LO SCASSO - Security

0 Nessuna resistenza allo scasso
No burglary resistance

1 Ridotta resistenza allo scasso
Mild burglary resistance

2 Media resistenza allo scasso
Moderate burglary resistance

3 Alta resistenza allo scasso
High burglary resistance

4 Resistenza estremamente alta allo scasso
Extremely high burglary resistance

CATEGORIA DI UTILIZZO - Category of use

1 Utilizzo medio
Medium duty

2 Utilizzo pesante
Heavy duty

RESISTENZA ALLA CORROSIONE - Corrosion resistance

0 Nessuna resistenza definita alla corrosione (nessun test)
No defined corrosion resistance (no test)

1 Ridotta resistenza alla corrosione (test nebbia salina 24h)
Low corrosion resistance (salt spray test 24h)

2 Media resistenza alla corrosione (test nebbia salina 48h)
Mid corrosion resistance (salt spray test 48h)

3 Alta resistenza alla corrosione (test nebbia salina 96h)
High corrosion resistance (salt spray test 96h)

4 Resistenza molto alta alla corrosione (test nebbia salina 240h)
Very high corrosion resistance (salt spray test 240h)

5 Resistenza estremamente alta alla corrosione (test nebbia salina 480h)
Extremely high corrosion resistance (salt spray test 480h)

Certificazione EN13126-3_Certification EN 13126-3

Standardizzazione europea per maniglie per finestre e porte finestre
European standardisation for windows and door height windows hardware

Sistema DK_System DK

R15
DK

**Baubeschläge, Beschläge für Fenster und Fensterlären
gemäß EN 13126-3 : 2011**

Nr. 12-001092-PR01
(G05-03-de-01)

ifft
ROSENHEIM

Grundlagen
EN 13126-1 : 2011
EN 13126-2 : 2011
Prüfnorm:
EN 13126-3 : 2011

Entsprechende nationale Festlegungen (z.B. DIN EN):
Darstellung



Verwendungsbeispiel
Dieser Prüfbericht dient dazu, Nachweise der Anforderungen an Baubeschläge für Fenster und Fensterlären gemäß EN 13126-3 : 2011 zu bestätigen. Die Konformität mit EN 13126-3 : 2011 ist festzustellen durch die Konformitätserklärung des Herstellers und die Konformitätserklärung des Herstellers sind zu beachten.

Geprüft
Die genannten Daten und Einzelangaben beziehen sich auf die zu prüfenden Produkte. Die Konformität ist zu lange das Produkt (Anforderung) und die (z.B. Grundlagen) sind nicht getrennt haben. Die Ergebnisse sind unter Beachtung entsprechender Festlegungen der Produktdaten in Eigenverantwortung der Hersteller, Geprüften werden. Diese Festlegung ermöglicht keine Aussage über weitere Leistungs- und Qualitätsmerkmale Eigenschaften, insbesondere Fertigungs- und Abbindeverfahren werden nicht berücksichtigt.

Verfälschungsfeststellung
Es gilt das Merkmal "Verfälschungsfeststellung". Das Merkmal kann als Nachweis verwendet werden. Der Nachweis umfasst insgesamt 17 Seiten.

Hersteller
Auftraggeber: **JATEC GmbH**
Maybachstrasse 4
63322 Rödermark
Deutschland

Produkt
drehabar Fenstergriff

Bezeichnung
Fensterolive / System DK / 171/015-A171DK015

**Leistungsmerkmale
Produktmerkmale**
Ausführung: Fenstergriff mit Getriebe,
Material: Messing,
Bediengröße: 43 mm,
Art der Befestigung: Verschraubung
Anzahl der Befestigungselemente: 2 Stück,
Bediengröße: metrische Schrauben M5 x 40 mm,
Getriebe: 19,0 mm,
Größe: 112,2 mm,
Größe (Ø x L x H): 26,0 mm x 62,2 mm x 10,5 mm

Sonderheiten
Keine

Ergebnis
Klassifizierung gemäß EN 13126-3 : 2011

Ge- brauchs- kategorie	Dauer- funktion- fähigkeit	Minimale	Fest- stärkig- keit	Ge- brauchs- sicherheit	Korrosi- ons- beständig- keit	Schutz- stärkung	Anwen- dung	Prüf- größen
2	5/180	-/-	0	1	2	0	3/C1	-/-

ifft Rosenheim
30. August 2012

Andreas Matzch
Andreas Matzch, Dipl.-Ing. (FH)
Prüfingenieur
Bauteile

Pascal Geiger
Pascal Geiger, Dipl.-Ing. (FH)
Prüfingenieur
Bauteile

ifft Rosenheim GmbH
Ludwig-Rosenheim-Str. 1
83054 Rosenheim
Tel: +49 (0)89 2400-100
Fax: +49 (0)89 2400-300
www.ifft-rosenheim.de

ifft Rosenheim GmbH
Ludwig-Rosenheim-Str. 1
83054 Rosenheim
Tel: +49 (0)89 2400-100
Fax: +49 (0)89 2400-300
www.ifft-rosenheim.de

ifft Rosenheim GmbH
Ludwig-Rosenheim-Str. 1
83054 Rosenheim
Tel: +49 (0)89 2400-100
Fax: +49 (0)89 2400-300
www.ifft-rosenheim.de

DIN EN13126-3

Questa parte della EN 13126 stabilisce i requisiti e i metodi di prova per la durabilità, la forza, la sicurezza e la funzionalità di maniglie per finestre e porte finestre. La norma si applica a maniglie Dreh Kipp (DK) anta ribalta ed a battente.

This part of EN 13126 specifies the requirements and test procedures for durability, strength, security and functionality of Tilt and Turn and Turn-Only window handle door height windows. The technical specifications are valid for Dreh Kipp (DK).

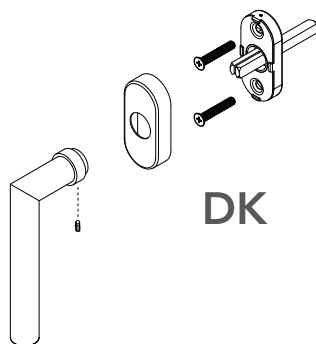

DK



I Processi di Gestione della Qualità

Quality Management Processes

Misurazione analisi e miglioramento

Measurement Analysis and Improvement

- Valutazione del fornitore - Supplier evaluation
 - Audit - Audit
 - Non conformità - Non conformities
 - Azioni correttive e preventive
- Soddisfazione del cliente - Customer Satisfaction

Controlli sul processo/prodotto

Check on process/product

- Controllo visivo - Visual inspection
- Controllo dimensionale (*primari certificati SIT*)
Dimensional control (Primary certificates SIT)
- Prova corrosione con NBS - Corrosion test with NBS
 - Prova adesione - Adherence test
 - Prova resistenza chimica dei rivestimenti
Test of coatings chemical resistance
- Prova meccanica di simulazione all'uso prolungato
Mechanical test of extended use simulation

6.

5.

4.

REGU
Handles & A

Qua

Approvvigionamento

Purchasing

- Richiesta offerta - Request for offer
- Verifica qualità (precampionatura) - Quality check (first samples)
- Contratto di fornitura - Supply contract

Commerciale

Sales office

- 
- Richiesta del cliente - Customer request
 - Verifica dei requisiti - Review of requirement related to the product
 - Comunicazione con il cliente - Customer communication

Progettazione

Project

- Pianificazione - Planning
- Riesame - Review
- Verifica - Verification
- Validazione - Validation

Produzione

Production

- Pressofusione - Diecasting
- Tranciatura - Punching
- Lavorazioni meccaniche - CNC machining
- Tornitura di ripresa con robot - Turning with Robots
- Smergliatura - Frosting
- Rotofinitura - Mass metal finishing
- Lucidatura - Polishing
- Rivestimenti galvanici - Galvanic chromium plating
- Marchiatura laser - Laser marking
- Assemblaggio - Assembly
- Confezionatura - Packaging
- Spedizione - Shipment
- Rintracciabilità - Traceability

Il Laboratorio di prove e collaudi *Product Testing Laboratory*



La Reguitti S.p.A. investe costantemente risorse nella ricerca e sviluppo.

Dal 2011 è in funzione al 100% un laboratorio interno che si occupa principalmente di:

- Ricerca e sviluppo di nuove tecnologie, prodotti e materiali.
- Controllo assenza di radiazioni sulle materie prime in entrata.
- Controllo sistematico dei rivestimenti superficiali:

PROVA DI CORROSIONE CON MACCHINA NEBBIA SALINA SECONDO NORMA UNI EN ISO 9227:2006

Verifica la resistenza dei rivestimenti superficiali alla corrosione in ambienti aggressivi con presenza di salsedine, piogge acide, vapori di detersivi o solventi.

PROVA DI ADESIONE MEDIANTE QUADRETTATURA SECONDO NORMA UNI EN ISO 2409:1996

Valuta l'ancoraggio di un rivestimento superficiale al supporto di base.

PROVA DI RESISTENZA CHIMICA

Valuta la tenuta di un rivestimento superficiale al contatto prolungato con prodotti chimici che possono normalmente essere utilizzati dall'utente (ad esempio detersivi per la pulizia)

PROVA DI RESISTENZA ALL'USURA

Valuta la durata nel tempo di un rivestimento superficiale. Con la prova viene simulato un sfregamento (avanti-indietro), utilizzando un tampone abrasivo con una pressione costante sul supporto.

PROVA DI DURATA DEL FUNZIONAMENTO MECCANICO

Attraverso l'ausilio di attrezzature specifiche e di un robot antropomorfo, vengono effettuati test meccanici per simulare il prolungato e costante utilizzo fino ad individuare il punto di stress.

Reguitti S.p.A. invests annually in research and development.

Since 2011, is operating a *Product Testing Laboratory* which is mainly dealing with:

- Research and development of new technologies, products and materials.
- Control the absence of radiation on materials in entrance.
- Systematic control of surface coatings:

CORROSION TEST WITH SALT FOG MACHINE According to UNI EN ISO 9227:2006

This test is used to check the resistance of the coatings surface corrosion in harsh environments with presence of salt, acid rain, steam of cleaners or solvents

PROOF OF ADHESION BY GRID According to UNI EN ISO 2409:1996

This test is used to assess the anchoring of a surface coating to the support base.

CHEMICAL RESISTANCE

This test is used to assess the durability of a coating surface for continuous contact with chemicals which can normally be used by the user (such as detergents for cleaning).

WEAR RESISTANCE

This test is used to assess the durability of a surface coating. With the test is simulated friction (forward-backward), using an abrasive pad with a constant pressure over the piece.

MECHANICAL OPERATION DURATION TEST

Through the use of specific equipment and a anthropomorphic robot, various mechanical tests are simulated to check the resistance and mechanical performance of components and products with particular critical resistance.

Resistenza Finiture_ *Finishes Resistance*

	FINITURA <i>Finish</i>	RESISTENZA MINIMA TESTATA ALLA CORROSIONE SALINA	MINIMUM RESISTANCE TESTED TO SALT CORROSION	NOTE Notes
LV	OTTONE LUCIDO VERNICIATO	600 ore - hours		
OS	OTTONE SATINATO VERNICIATO	600 ore - hours		
BG	OTTONE BRONZATO GRAFFIATO	600 ore - hours		
BGO	OTTONE BRONZATO GRAFFIATO OPACO	800 ore - hours		Viene utilizzato un processo di verniciatura che ha dimostrato maggiore resistenza rispetto alla produzione precedente <i>It is used a coating process that has improved the resistance compared to previous production process.</i>
AN	OTTONE ANTICO	800 ore - hours		Viene utilizzato un processo di verniciatura che ha dimostrato maggiore resistenza rispetto alla produzione precedente <i>It is used a coating process that has improved the resistance compared to previous production process.</i>
RX	OTTONE RUGGINE	800 ore - hours		Viene utilizzato un processo di verniciatura che ha dimostrato maggiore resistenza rispetto alla produzione precedente <i>It is used a coating process that has improved the resistance compared to previous production process.</i>
AGV	ARGENTO VECCHIO	800 ore - hours		Viene utilizzato un processo di verniciatura che ha dimostrato maggiore resistenza rispetto alla produzione precedente <i>It is used a coating process that has improved the resistance compared to previous production process.</i>
OC	OTTONE CROMATO LUCIDO	1200 ore - hours		
OSC	OTTONE SATINATO CROMATO	1000 ore - hours		
SNV	SATINATO NICHEL VERNICIATO	600 ore - hours		
PVD	PVD ORO	2200 ore - hours		
	PVD INOX	2200 ore - hours		
ZCR	ZAMA CROMATA LUCIDA	1000 ore - hours		
ZSC	ZAMA SATINATA CROMATA	800 ore - hours		
INOX SAT.	ACCIAIO INOX SATINATO	1500 ore - hours		

I MATERIALI

MATERIALI PRINCIPALMENTE UTILIZZATI

OTTONE

La lega Ottone (composta principalmente da Rame e Zinco) è un materiale duttile, malleabile e ha una buona resistenza alla corrosione, fonde a più di 900°.

Reguitti utilizza:

- Pani ottone pressafinato norma UNI EN 1982 ENCB753S
- Barra ottone a norma UNI EN12165 CW617N secondo il ciclo produttivo standardizzato
- Stampaggio a caldo o pressofusione
- Smerigliatura, per levigare e sgrossare il pezzo
- Vibratura, per levigare l'intera superficie e facilitare le successive lavorazioni
- Spazzolatura e rinvivatura per avere un effetto lucido brillante oppure satinatura per ottenere un effetto graffiato opaco
- Trattamenti superficiali che proponiamo in molteplici tonalità cromatiche e differenti texture

ZAMA

La lega Zama (composta principalmente da Zinco, Alluminio e Magnesio) è particolarmente adatta alla pressofusione fonde a più di 400°.

Reguitti utilizza lega di Zama primaria di tipo 410 EN 1774

secondo il ciclo produttivo standardizzato:

- Pressofusione
- Smerigliatura e spuntigliatura per levigare il pezzo
- Spazzolatura e rinvivatura per avere un effetto lucido oppure satinatura per ottenere un effetto graffiato opaco
- Rivestimento galvanico di Rame per isolare e proteggere la zama da eventuali agenti corrosivi
- Rivestimento galvanico oppure rivestimento PVD

AVVERTENZE

L'ottone e la zama sono leghe soggette all'ossidazione, vulnerabili all'azione del tempo e dell'usura, in relazione ai diversi tipi di finiture e all'intensità di utilizzo.

Si raccomanda di:

- Spolverare o pulire il prodotto con panni morbidi o scamosciati
- Lavare con acqua tiepida o detersivi a pH neutro diluito
- Effettuare la pulizia dei prodotti verniciati e/o galvanizzati almeno ogni 2 mesi (se gli articoli sono posti all'esterno, si consiglia ogni mese). Nel caso di prodotti installati in località o in zone con molte salinità, si consiglia di effettuare la pulizia ogni due settimane (se gli articoli sono posti all'esterno, si consiglia ogni settimana)

Evitare nel modo più assoluto:

- Di installare il prodotto in ambienti freschi di pittura (attendere l'essiccazione completa di qualsiasi tipo di tinteggiatura, su muro, legno o su pavimento)
- di installare il prodotto nelle vicinanze di parquet in legno appena posati e verniciati, pavimenti in marmo e granito appena levigati **quindi montare le guarniture SOLO DOPO aver eseguito tutti i lavori**
- L'uso di sostanze corrosive contenenti acqua ossigenata, cloruri e fluoruri
- La scalfitura ad opera di oggetti quali pagliette abrasive, chiavi, anelli, cacciaviti, viti ed altri oggetti appuntiti

Attenzione: **anche i prodotti con trattamenti speciali PVD e PVD INOX, se all'esterno, devono essere TASSATIVAMENTE puliti ogni 4-6 mesi, ogni mese se installati in località marine, o in zone con molta salinità**, questo per togliere eventuali tracce di calcare o ruggine aerea, dovute al deposito a seguito di un naturale influsso ambientale.

THE RAW MATERIALS

MAIN MATERIALS USED IN THE PRODUCTION PROCESS

BRASS

The brass alloy (composed mainly of copper and zinc) is a ductile material, malleable and has a good corrosion resistance, melts at over 900 °.

The brass we use is:

- Brass ingots according to UNI EN ENCB753S 1982-2008.
- Brass bar UNI EN12165 CW617N
- The standard production cycle is made with
- Hot forging or casting
- Frosting, smoothing and roughing the piece
- Vibrating, to uniform the entire surface and facilitate subsequent processing.
- Brushing and polishing to have a shiny finish or satin to achieve a matt brushed effect.
- This is followed by surface treatments that offer a variety of solutions

ZAMAK

Zamak alloy (composed mainly of zinc, aluminum and magnesium) is particularly suitable to casting, and it melts at over 400 °.

The Zamak alloy we are using is the EN 410 1774 type

The standard production cycle:

- Die casting
- Frosting and smoothing the piece
- Brushing and polishing to have a shiny finish or satin to achieve a matt brushed effect
- Copper galvanic plated to isolate and protecting the Zamak alloy against any corrosive agents
- PVD coating or galvanic coating

WARNINGS

The brass and the Zamak alloys are subject to oxidation, vulnerable to the action of time and wear, in relation to different types of finishes and intensity of use.

It is recommended to:

- Dust or clean the product with a soft cloth or chamois leather
- Wash with warm soapy water or diluted neutral pH detergents
- Clean the varnish and/or galvanized products at least every 2 months (if the items are outside, it is recommended to do it every month) In the case of products installed in areas with a lot of salinity, it is recommended to clean every two weeks (if the items are outside, it is recommended to do it each week).

Avoid, in any way:

- To install the product in environments recently painted (wait for the complete drying of all types of painting, on the wall, on the wood or on the floor)
- To install the product nearby newly laid wooden floors and painted, marble floors and granite just smooth. **Therefore please mount the handles and accessories ONLY AFTER the end of these works**
- The use of corrosive substances containing hydrogen peroxide, chlorides and fluorides
- The scratching by blunt objects such as scouring pads, keys, rings, screwdrivers, screws or other sharp items

Attention: **even products with the special treatments PVD and PVD INOX, if mounted outside, must be ABSOLUTELY cleaned every 4-6 months; every month if they are installed in seaside resorts, or in areas with a lot of salinity**, in order to remove any trace of aerial calcareous or rust due to the deposit as a result of a natural environmental influence.

Rivestimenti Superficiali *_Surface Coatings*

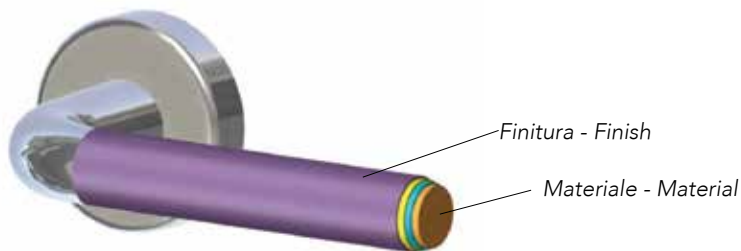

Ottone Verniciato (LV-OS)
Varnished Brass (LV-OS)

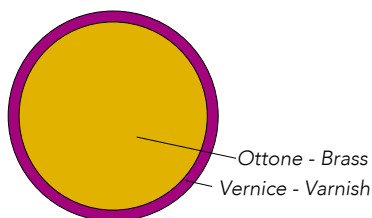

Zama Nichelata Verniciato (SNV)
Zamak Satin Nickel Plated Varnished (SNV)

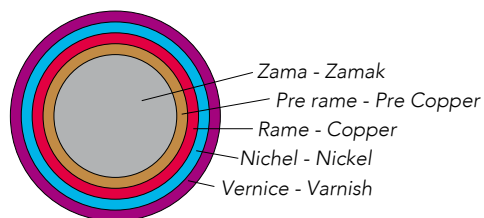

Ottone Nichelato Verniciato (SNV)
Brass Satin Nickel Plated Varnished (SNV)

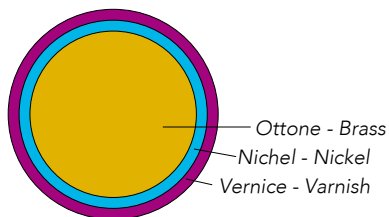

Zama Cromata (ZCR - ZSC)
Chromed Zamak (ZCR - ZSC)

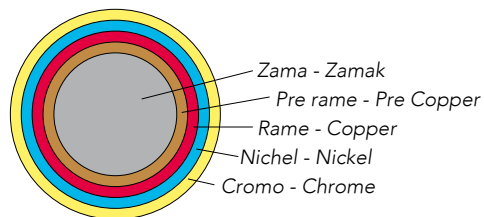

Ottone Cromato (OC - OSC)
Chromed Brass (OC - OSC)

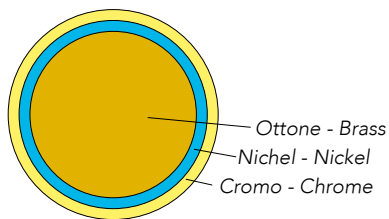

Zama PVD (PVD)
Zamak PVD (PVD)

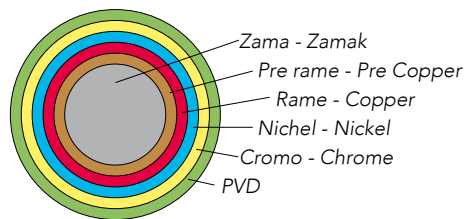

Ottone Anticato (AN - BG - BGO)
Antique Brass (AN - BG - BGO)

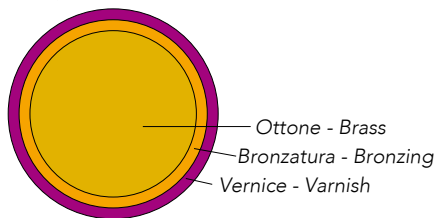

Ottone Argento vecchio (AGV)
Old Silver (AGV)

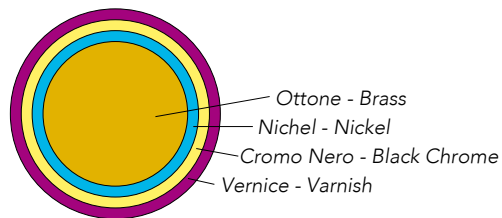

Derivante direttamente dalle applicazioni per l'industria aerospaziale, medica e automobilistica il PVD (Physical Vapour Deposition) è l'unico trattamento finora in grado di offrire un'elevata e durevole protezione superficiale della maniglia al fine di resistere al graffio e alla corrosione.

REGUCCI consiglia l'impiego di prodotti trattati con PVD per l'installazione sugli infissi esterni e in ogni ambiente soggetto ad agenti aggressivi, soprattutto in zone soggette a piogge acide ed in aree marine ricche di salsedine. Reguitti recommends to install products treated with PVD coating finish for external doors and windows, in every environment subjected to aggressive agents, especially in areas of acid rains and seaside areas rich of salinity.

REGUCCI garantisce su questo prodotto la protezione dalle alterazioni superficiali (in normali condizioni di utilizzo) per almeno 10 ANNI.

Attenzione: anche i prodotti con trattamenti speciali PVD e PVD INOX, se all'esterno, devono essere TASSATIVAMENTE puliti ogni 4-6 mesi, ogni mese se installati in località marine, o in zone con molta salinità, questo per togliere eventuali tracce di calcare o ruggine aerea, dovute al deposito a seguito di un naturale influsso ambientale.

COATING BY PVD PROCESS

This product have been treated with the new PVD process (Physical Vapour Deposition). It is proof against wear and corrosion thanks to it's surface hardness being completely abrasion free.

This protective feature makes product especially suitable for external use such as public buildings, shops, hotels, offices etc.

guarantees protection from alterations and from superficial abrasions. The aesthetic characteristics will be maintained for at least 10 YEARS (in normal use and cleaning conditions).

Attention: even products with the special treatments PVD and PVD INOX, if mounted outside, must be ABSOLUTELY cleaned every 4-6 months; every month if they are installed in seaside resorts, or in areas with a lot of salinity, in order to remove any trace of aerial calcareous or rust due to the deposit as a result of a natural environmental influence.



PROVE / TEST	RISULTATI / RESULTS
Resistenza in nebbia salina Resistance to salt spray test (ISO 9227 ASTM B117 DIN 50021)	2000 ore 2000 hours
Durezza - Hardness	2000/2500 Vickers
Resistenza ai solventi Resistance to solvents (TEST MKF)	ILLIMITATA UNLIMITED
Resistenza all'acido muriatico Resistance to muriatic acid	ILLIMITATA UNLIMITED
Resistenza a prodotti specifici anticalcare Resistance to specific anti-calcareous products	ILLIMITATA UNLIMITED
Solidità del colore alla luce (senza alterazione) Colourfastness in the presence of light (without change) (UNI 9397 - ASTM G53)	ILLIMITATA UNLIMITED

BRONZO UNIFORME



COLOUR

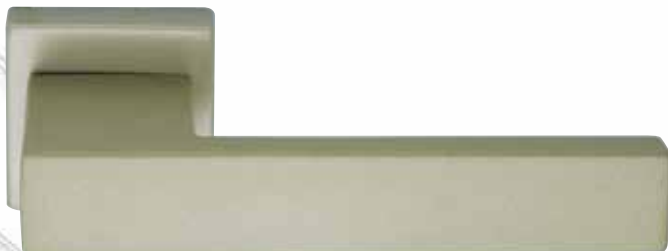

SABBIA / SAND



AVORIO / IVORY



NERO / BLACK

DECORO



SC/D2



NR/D2

Nuova finitura Zama Lucida Verniciata

New Finish Zamak Polished Brass Effect

art.031 SABINA



031 MR 009 - ZLV



031 MR 004 - ZLV



031 DK 015 - ZLV

art.171 ALISE'



171 MR 009 - ZLV



171 MR 004 - ZLV



171 DK 015 - ZLV

art.183 BETTY



183 MR 009 - ZLV



183 MR 004 - ZLV



183 DK 015 - ZLV

Finiture
Finishes

ZLV



VERSIONI / VERSIONS

MANIGLIA CON PLACCA / LEVER HANDLE ON PLATE €

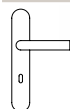

031 MP 224	Maniglia con placca Lever handle on plate	224 mm 233x41	con molla with spring	•	2
------------	--	---------------	--------------------------	---	---

MANIGLIA CON ROSETTA / LEVER HANDLE ON ROSE €



031 MR 004	Maniglia con rosetta Lever handle on rose	004 mm Ø45x9	con molla with spring	•	10
------------	--	--------------	--------------------------	---	----



031 MR 009	Maniglia con rosetta Lever handle on rose	009 mm 62x32	ovale con molla oval with spring	•	1
------------	--	--------------	-------------------------------------	---	---

DREH KIPP / DREH KIPP €



031 DK 015	Dreh kipp con rosetta Dreh Kipp on rose	015 mm 65x31	con movimento in metallo with metal mechanism	•	6
------------	--	--------------	--	---	---

MANIGLIA CON PLACCA / LEVER HANDLE ON PLATE €

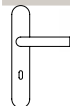

171 MP 224	Maniglia con placca Lever handle on plate	224 mm 233x41	con molla with spring	•	1
------------	--	---------------	--------------------------	---	---

MANIGLIA CON ROSETTA / LEVER HANDLE ON ROSE €



171 MR 004	Maniglia con rosetta Lever handle on rose	004 mm Ø45x9	con molla with spring	•	5
------------	--	--------------	--------------------------	---	---



171 MR 009	Maniglia con rosetta Lever handle on rose	009 mm 62x32	ovale con molla oval with spring	•	1
------------	--	--------------	-------------------------------------	---	---

DREH KIPP / DREH KIPP €



171 DK 015	Dreh kipp con rosetta Dreh Kipp on rose	015 mm 65x31	con movimento in metallo with metal mechanism	•	6
------------	--	--------------	--	---	---

MANIGLIA CON PLACCA / LEVER HANDLE ON PLATE €

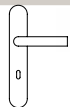

183 MP 224	Maniglia con placca Lever handle on plate	224 mm 233x41	con molla with spring	•	2
------------	--	---------------	--------------------------	---	---

MANIGLIA CON ROSETTA / LEVER HANDLE ON ROSE €



183 MR 004	Maniglia con rosetta Lever handle on rose	004 mm Ø45x9	con molla with spring	•	5
------------	--	--------------	--------------------------	---	---



183 MR 009	Maniglia con rosetta Lever handle on rose	009 mm 62x32	ovale con molla oval with spring	•	1
------------	--	--------------	-------------------------------------	---	---

DREH KIPP / DREH KIPP €



183 DK 015	Dreh kipp con rosetta Dreh Kipp on rose	015 mm 65x31	con movimento in metallo with metal mechanism	•	6
------------	--	--------------	--	---	---

PRONTA
CONSEGNA

SERVIZIO



entro il giorno successivo*
specificando nell'ordine "servizio SRG"

ORDINA TRAMITE:

Tel.: 0365 896186 servizio attivo dalle 8:00 alle 12:00 e dalle 13,30 alle 18,00

Fax: 0365 896137 servizio attivo 24 ore su 24

E-mail: sales@reguitti.it servizio attivo 24 ore su 24

*CONDIZIONI DEL SERVIZIO:

- Per articoli predefiniti - Elenco disponibile su www.reguitti.it/srg
- Per ordini ricevuti ENTRO LE ORE 11,00 DEFINITI IN OGNI DETTAGLIO (articolo, finitura, versione, quantità) viene garantita la spedizione ENTRO IL GIORNO SUCCESSIVO con corriere espresso fino ad un massimo di 30 KG.
- Costo del servizio più trasporto fino a 30 kg: € 15,00 + IVA.
- I prezzi indicati si intendono IVA ESCLUSA.
- Per le caratteristiche tecniche degli articoli illustrati si fa riferimento al Catalogo Listino Prezzi 2010.

SMG

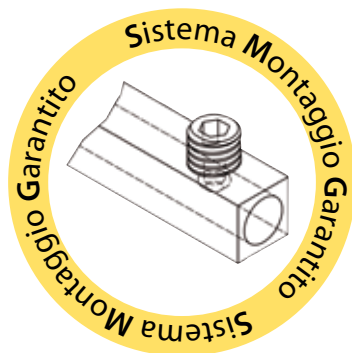

SMG - Sistema Montaggio Garantito con ferro forato e grani speciali CDF6

VANTAGGIO:

- Fissaggio **stabile e duraturo** del grano sul ferro e quindi, della maniglia sulla porta



Set. CDF6

S M R

Servizio Montaggio Rapido

con Grani Premontati



VANTAGGI:

- Semplificazione e **riduzione significativa** del tempo di montaggio della maniglia sulla porta

Servizio **disponibile a richiesta** sui seguenti modelli, finiture e imballi versione con rosette e bocchette foro chiave patent

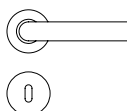

40 - GINEVRA

A040MR004 ANTICO



171 - ALISE'

A171MR004 LV - OSC - ZSC
A171MR416 LV - OSC - ZSC



31 - SABINA

A031MR004 LV - OSC - ZSC
A031MR416 LV - OSC - ZSC



173 - SASHA

A173MR004 OS/LV - ZSC/ZCR/OSC
A173MR416 OS/LV - ZSC/ZCR/OSC



124 - Q-ARTE

A124MRQ86 ZSC



130 - LASER

A130MRQ08 OSC - ZSC



183 - BETTY

A183MR004 LV - OSC - ZSC
A183MR416 LV - OSC - ZSC



PROTEZIONE STRIP / PROTECTION STRIP

PELLICOLA SPECIALE A STRAPPO PROTEGGI IMPUGNATURA "PRIMA DELL'USO". SPECIAL PROTECTION FILM TO BE REMOVED AFTER INSTALLATION

Sistema adatto soprattutto per le finestre in quanto queste vengono installate ancora prima di fare le molte rifiniture dei pavimenti e pareti, da rimuovere a lavori terminati.

System suitable especially for windows that are installed before the finishes of walls and floors, to be removed when building workings are completed.



PER I MANIGLIONI ALZANTI
FOR SLIDE AND LIFT SYSTEM PULL HANDLES
Fornita standard su finiture LV e OS
Pull/strip bag supplied with LV and OS finishes

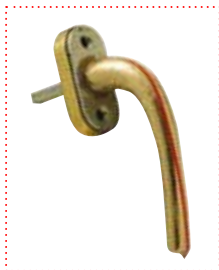

PER DK CON ROSETTA
FOR WINDOW HANDLE ON ROSES
Fornita solo su richiesta e per modelli selezionati
On request ONLY and for selected models



PER MANIGLIE CON ROSETTA
FOR LEVER ON ROSES
Fornita solo su richiesta e per modelli selezionati
On request ONLY and for selected models

LOGO PERSONALIZZATO CUSTOM LOGO



PERSONALIZZAZIONE LOGO SU RICHIESTA
quantità da definire

CUSTOMER LOGO ON REQUEST
quantity to be agreed



ARGENTO SU
OSC



NERO SU OSC



ORO SU LV



NERO SU LV



Zama Verniciata Ecologica_ Ecological Varnished Zamak

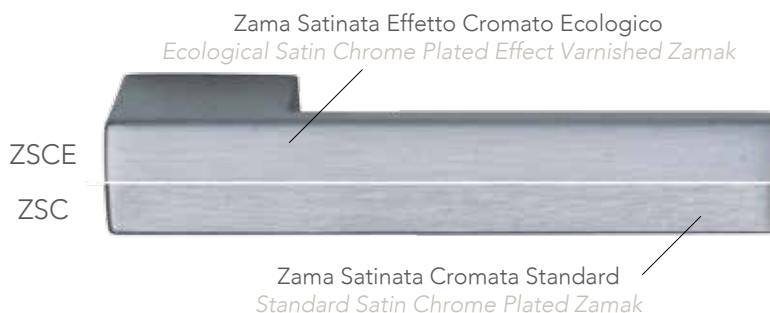
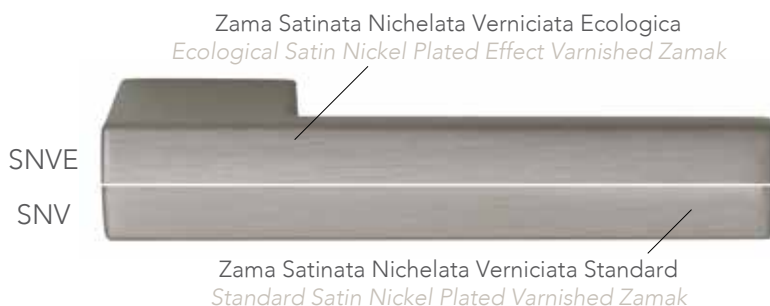

Verniciatura che può sostituire su richiesta i trattamenti galvanici ZSC e SNV sulla Zama.

Vantaggi:

- Evita il rischio di corrosione inter-cristallina (dovuto al contatto tra nichel e alluminio contenuto nella zama).
- Eco sostenibile in quanto si evita l'uso del cromo, e anallergico in quanto si evita l'uso del nichel.
- Resistenza in nebbia salina pari o maggiore al rispettivo trattamento galvanico con base cromo
- Esteticamente paragonabile alla rispettiva finitura tradizionale galvanica.

On demand the Ecological coating can replace the galvanic plating SNV or ZSC on Zamak products

MAIN ADVANTAGES:

- It avoids the risk of inter-crystalline corrosion (due to contact between nickel and aluminum content in zinc alloy)
- Eco sustainable because it avoids the use of chromium and non-allergenic because it is nickel free
- Resistance to salt spray equal or greater than the corresponding chromium electroplating based
- Aesthetically the same to their traditional plating finish

	FINITURA FINISH	RESISTENZA MINIMA TESTATA ALLA CORROSIONE SALINA MINIMUM RESISTANCE TESTED TO SALT CORROSION (5% solution)
SNVE	ZAMA NICKEL SATINATA VERNICIATA ECOLOGICA	900 ore / hours
ZSCE	ZAMA CROMO SATINATA ECOLOGICA	900 ore / hours

SPECIFICHE COMMERCIALI

ORDERING DETAILS LIST

COME EFFETTUARE L'ORDINE DI MANIGLIE

Onde evitare errori o incomprensioni in fase di eva-
sione dell'ordine e per velocizzare la consegna, si rec-
comanda di indicare sempre le seguenti specifiche:

- Codice dell'articolo
- Finitura
- Quantità
(nel rispetto del minimo per confezione)
- Eventuali varianti esecutive

HOW TO ORDER LEVER HANDLE

In order to avoid mistakes during carrying out the
order and to have a quick delivery, we strongly rec-
ommend you to provide the following details:

- Item code
- Finish
- Quantity
(according to minimum packaging requested)
- Possible products changing

MANIGLIE PER PORTE

Per comporre il Vostro ordine, scegliete tra le seguen-
ti opzioni (per esclusione):

DOOR HANDLES

Please, order choosing between the following options
(by elimination):

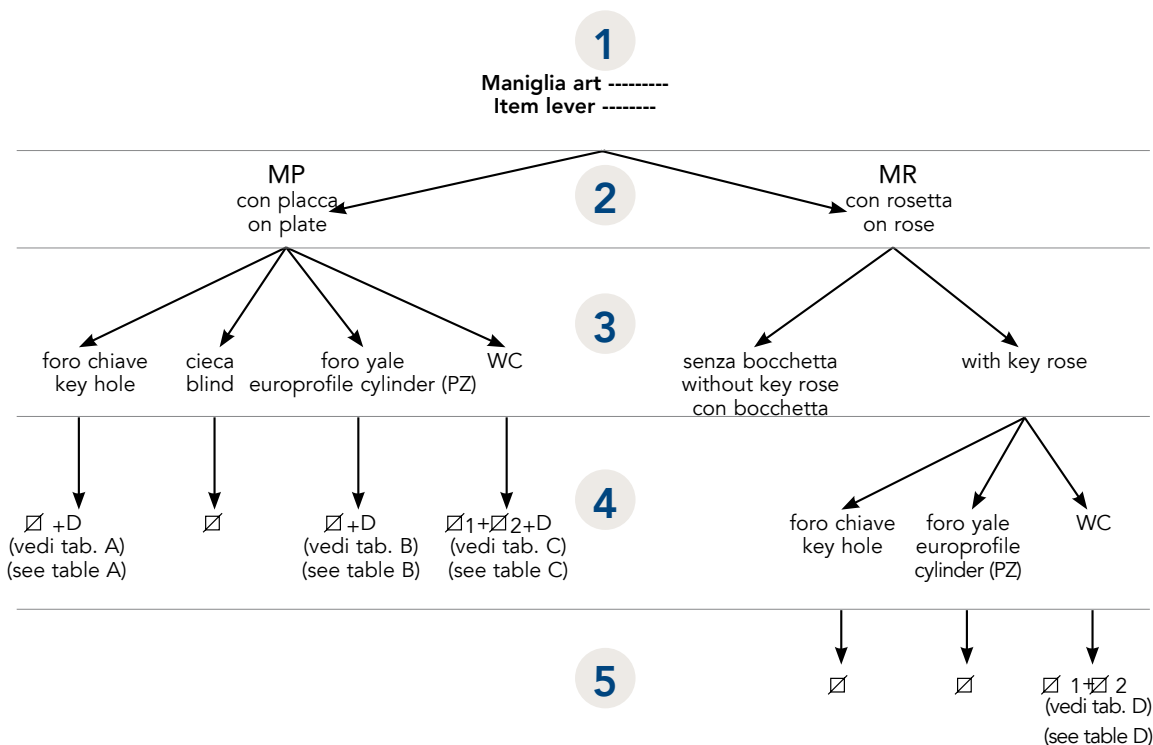

SPECIFICHE TECNICHE TECHNICAL DETAILS LIST

TAB. A - FORO CHIAVE
TABLE A - KEY HOLE

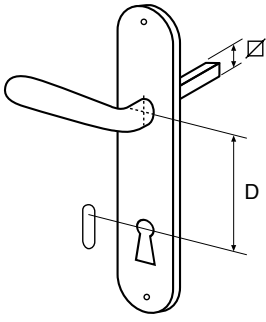

∅	D
6	70
7	70
8	55
	56
	57
	70
	72
	75
	78
	90
	92
	110
8,5	90

TAB. B - FORO YALE
TABLE B - EURO PROFILE CYLINDER (PZ)

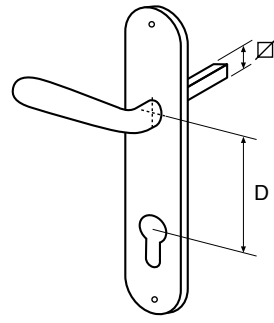

∅	D
7	70
8	47,5
	55
	61
	72
	78
	85
	90
	92
	110
	8,5
10	92

TAB. C - WC CON PLACCA
TABLE C - WC ON PLATE

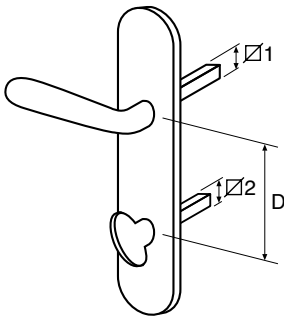

∅ 1	∅ 2	D
7	6	70
8	5	57
		72
		105
8	6	47
		70
		72
		90
		96
		55
8	8	57
		63
		72
		78
		85
		90
8,5	7	90

TAB. D - WC CON ROSETTA
TABLE D - WC ON ROSE

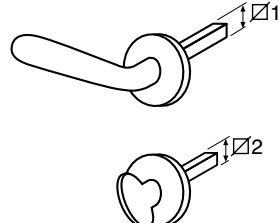

∅ 1	∅ 2
7	6
8	5
8	6
8	8
8,5	7

SPECIFICHE TECNICHE TECHNICAL DETAILS LIST

MANIGLIE PER FINESTRE

Per comporre il Vostro ordine, scegliete tra le seguenti opzioni (per esclusione):

WINDOWS HANDLES

To order choose between the following options (by elimination)

1

Art -----
Item lever -----

2

MA



martellina
window handle without mechanism
cremonesi

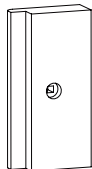

CR



window handle with mechanism
dreh kipp

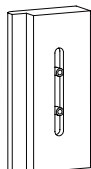
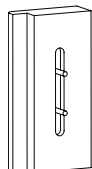

DK



Vedi tab. E
See table E

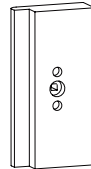

TAB. - E

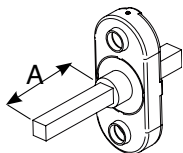

DK Tradizionali smontati con grano e ferro q.7 fisso - movimento 4 scatti
Unassembled DK system with grub screw and fixed length 7 mm spindle - 4 position mechanism

A standard = 42 mm

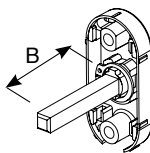

DK premontati senza grano e ferro q.7 fisso - movimento 4 scatti*
Pre-assembled DK system without grub screw and fixed length 7 mm spindle - 4 position mechanism*

B misura a richiesta:
32-37-42-45-50-60 mm

TABLE - E

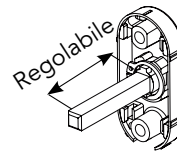

DK premontati senza grano e ferro q.7 regolabile - movimento 4 scatti*
Pre-assembled DK system without grub screw with adjustable 7 mm spindle - 4 position mechanism*

regolabile da 30 a 50 mm



con bussole/with bushes



senza bussole/without bushes

*A richiesta movimento a 8 scatti / On Request 8 position mechanism

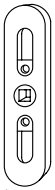

Gratz con fori

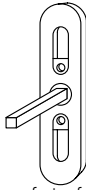

Gratz con fori e ferro $\nabla 7$

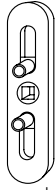

Gratz con bussole

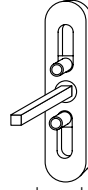

Gratz con bussole e ferro $\nabla 7$



Gratz con perni

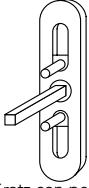

Gratz con perni e ferro $\nabla 7$

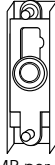

G.MP per aste a vista (esterne)

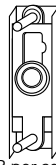

MP per aste incassate (interne)

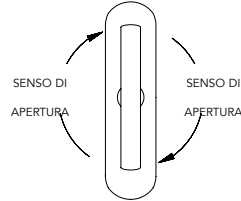

TUTTI I MOVIMENTI STANDARD APRONO LA FINESTRA IN SENSO ORARIO

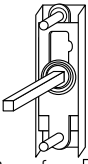

MP con ferro $\nabla 7$ per aste incassate (interne)

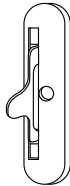

Gola lupo laterale

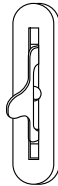

Gola lupo centrale

Vedi gamma completa dei movimenti nel capitolo "ACCESSORI TECNICI"

See complete range on chapter "TECHNICAL COMPONENTS"

APPLICAZIONI A RICHIESTA ON REQUEST



MEZZE MANIGLIE

HALF HANDLES

Convenzioni della mano

Handing

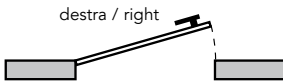

destra / right

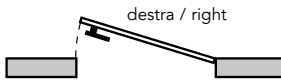

destra / right



destra / right

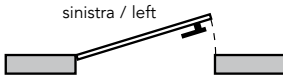

sinistra / left

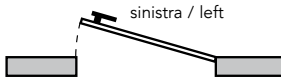

sinistra / left



sinistra / left

PREZZO/PRICE = $\frac{\text{prezzo maniglia completa/lever handle price}}{2}$

MANIGLIE E COPPIE POMOLI SU ROSETTA SENZA BOCCHETTA

LEVER HANDLES AND PAIR KNOBS ON ROSE WITHOUT KEY ROSE

Detrazione del prezzo della bocchetta stessa serie (vedi cap. "Soluzioni tecniche e componenti")

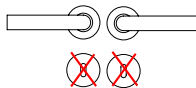
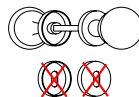

Amount to deduct: see price of key rose of each series in "Technical solutions and components"

BILANCINI

Coppia di impugnature (---CM---)
con ferro e grano, senza rosetta,
senza bocchetta.

PREZZO= a richiesta

CON IMPOSTA
WITH NECK

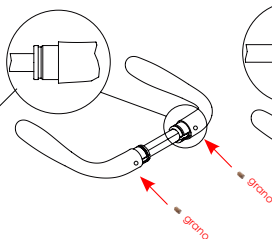

PAIR HANDLES WITHOUT ROSE

Pair handles (---CM---)
without rose, without key rose,
with square spindle and grub screw

PRICE= on request

SENZA IMPOSTA
WITHOUT NECK

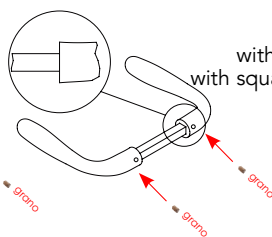

CREMONESI E MARTELLINE

Cremonesi e martelline con impugnatura
a maniglia (segretini):

--SG--
con Gioco

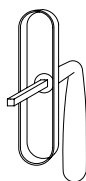

--SE--
con ferro $\varnothing 7$

Window handle with lever

POSIZIONE MANIGLIA
FINESTRA APERTA

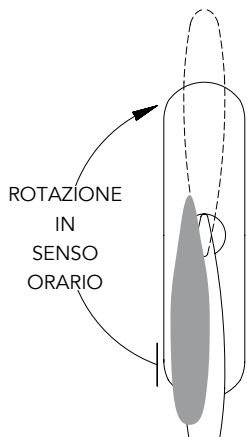

ROTAZIONE
IN
SENSO
ORARIO

POSIZIONE MANIGLIA
FINESTRA CHIUSA

A RICHIESTA E' POSSIBILE AVERE IL MOVIMENTO AL CONTRARIO,
SU PLACCHE **COPRIVITE** PER I MOVIMENTI GRAZ CON BUSSOLE



CREMONESI CON PLACCA COPRIVITE

WINDOW HANDLE WITH MECHANISM WITH COVER SCREW PLATE

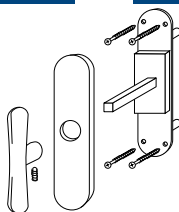

MARTELLINE CON PLACCA COPRIVITE

WINDOW HANDLE WITH 7 MM SPINDLE WITH COVER SCREW PLATE

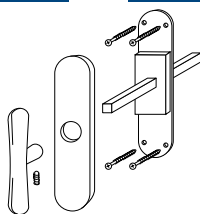

APPLICAZIONI DEI DREH KIPP DREH KIPP APPLICATIONS

APPLICAZIONE DREH KIPP CON GRANO

Per movimenti in metallo.
DK Tradizionali smontati con grano
e ferro q.7 fisso

(vedi gamma completa
nel cap. "ACCESSORI TECNICI")

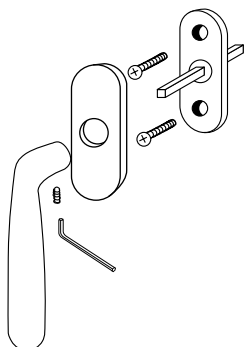

DREH KIPP APPLICATION WITH GRUB SCREW

For metal mechanism.
Unassembled DK system with grub screw
and fixed length 7 mm. spindle

(See complete range
on chapter "TECHNICAL COMPONENTS")

APPLICAZIONE DREH KIPP SENZA GRANO

Per movimenti in metallo senza grano,
preassemblato sull'impugnatura

DK premontati senza grano
e con ferro regolabile o fisso

(Prevista per modelli e finiture selezionati
e per quantità minime)

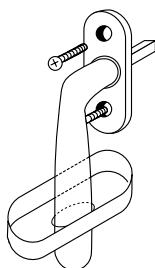

DREH KIPP APPLICATION WITHOUT GRUB SCREW

For metal mechanism
fixed on lever without grub screw

Pre-assembled DK system without
grub screw with adjustable or fixed 7 mm spindle.

(Application on request, only for chosen models
and finishes, for minimum quantities)

DREH KIPP CON IMPUGNATURA A T (TK)

Disponibile per tutte le impugnature a martellina (a T) con movimento in metallo

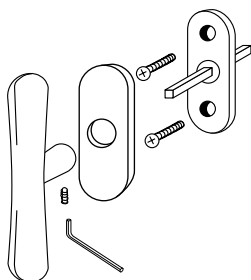

DREH KIPP WITH "T" SHAPE LEVER (TK)

It is possible to apply DK mechanism on all lever of window handle ("T" shape), with metal mechanism

DISPOSITIVI ANTI-EFFRAZIONE CON CHIAVE E CILINDRO KA STESSA CIFRATURA

Disponibile l'abbinamento per ogni maniglia



SAFETY WINDOW HANDLES WITH CYLINDER AND KEY ALIKE SYSTEM WITH 1 KEY FOR CYLINDER (KA)

Available for every lever handle

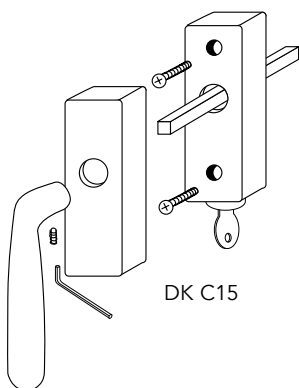

DK C15

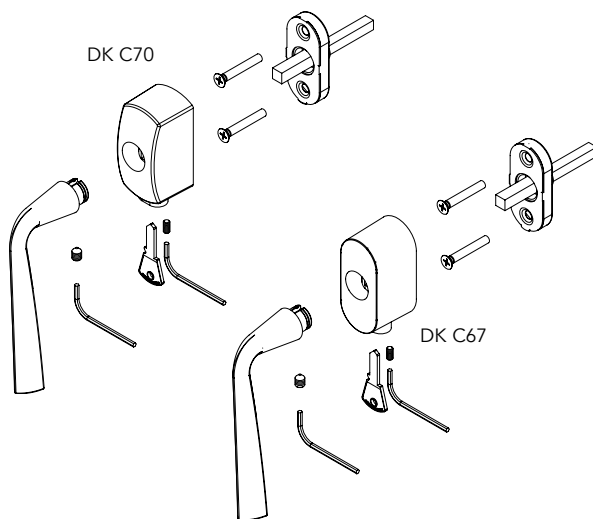

DK C70

DK C67

DISPOSITIVO ANTI-EFFRAZIONE CON PULSANTE

PATENTED SAFETY WINDOW HANDLE WITH PUSH BUTTON

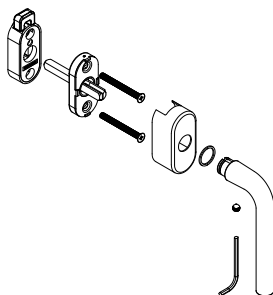





COS'È?: è il progetto antibatterico esclusivo di Reguitti a base di resina composta da IONI D'ARGENTO e vernice all'acqua (senza solventi chimici). È LA SOLUZIONE innovativa al problema contaminazione da Batteri-Germi.

PERCHE' IL PROGETTO: le statistiche indicano tra le principali cause di malattia proprio la contaminazione da contatto con batteri (ormai sempre più resistenti alle cure antibiotiche) che vivono e si coltivano sulle superfici di contatto più comunemente usate dalla popolazione. Nelle cliniche, nelle scuole, negli asili, nei luoghi privati e pubblici in genere, le maniglie sono continuamente azionate da più persone e sulla loro superficie si depositano e si coltivano batteri e germi che, in funzione del diverso grado di reazione del sistema immunitario che ogni soggetto umano possiede a diverso titolo, possono essere causa di stati di malattia più o meno gravi fino a provocare la morte nei soggetti più deboli. Reguitti ha investito nella ricerca e sviluppo assumendo personale chimico specializzato, incaricando laboratori di ricerca, ed esplorando nel panorama delle tecnologie antibatteriche per confrontare le diverse soluzioni ritrovate.

Questo percorso ha portato alla scelta della tecnologia a più alta efficacia con il minor costo per il prodotto finito.

Reguitti, prima nel settore, rende possibile uccidere i batteri su tutti i prodotti del suo catalogo.

COME FUNZIONA: Gli Ioni d'Argento vengono rilasciati lentamente dalla superficie Antigerm™ inibendo lo sviluppo dei batteri e provocandone la pressoché totale eliminazione (oltre il 99,99%) Questo trattamento è stato **CERTIFICATO** dai laboratori inglesi dell'autorevole IMSL Ltd secondo la normativa **ISO 22196** (Determination of Antibacterial Activity).

Previene, combatte ed elimina più di 650 specie di batteri, tra cui i più conosciuti e pericolosi Eschelina Coli

Staphylococcus Aureus

Staphylococcus Aureus Methicillin-Resistant (MRSA)

DURATA: L'attività del trattamento Antigerm™ è permanente e per tutta la vita utile del prodotto, 24 ore su 24, 7 giorni su 7, senza bisogno di essere rigenerato. Anche in caso di scalfitura della superficie gli ioni d'argento possiedono capacità di influenza garantendo l'attività antibatterica come dimostrato dai test di laboratorio.

RESISTENZA DELLA SUPERFICIE:

resistenza alla corrosione salina: oltre 1.000 ore (+ 66% rispetto a finitura Lucido Verniciato);

resistenza alla prova d'usura accelerata (sfregamento abrasivo*): oltre 4 volte la durata della finitura Lucida Verniciata senza trattamento Antigerm™.

IDENTIFICAZIONE: le maniglie con rivestimento Antigerm™ sono marchiate con il logo  attraverso un sistema a laser che lo rende indelebile.

GLOBALITA', COMPLETEZZA, ESTETICA: a differenza di altre superfici e materiali antibatterici, Antigerm™ offre il vantaggio di essere cromaticamente neutro e trasparente, potendo così essere applicato su qualsiasi finitura lasciandone inalterati tonalità e colore.

PERCHE' SCEGLIERE Antigerm™: si può affermare che Antigerm™, rispetto a bronzo, titanio e argento applicato in galvanica, offre una protezione antibatterica maggiore al prezzo minore.

SENSIBILITÀ, RESPONSABILITÀ, PRESTIGIO: prevenire i batteri è una norma igienica di base. Installare Antigerm™ è dimostrazione di sensibilità e responsabilità soprattutto verso i soggetti più deboli come bambini, persone anziane e/o con difese immunitarie indebolite.

Per i responsabili di strutture in genere aperte al pubblico, installare Antigerm™ è dimostrazione di responsabilità verso la salute pubblica.

Pubblicizzare l'utilizzo di Antigerm™ significa dare maggior prestigio alla propria struttura/abitazione.

www.antigerm.it

* rapporto di prova Commissione n°149 della Sala Prove e Controlli Reguitti S.p.A

ANTIGERM™

WHAT IS IT?: It is the REGUITTI exclusive antibacterial project, based on resin composed of silver ions and water based varnish (no presence of chemical solvents). It is an innovative solution to the contamination problem of bacteria and germs.

WHY THE PROJECT: statistics indicate among the most common causes of disease, the contamination with bacteria (more and more resistant to antibiotic treatment) that live and grow more commonly over the contact surfaces used by people. Clinics, schools, nurseries, private and public places in general, are the places where door handles are continuously activated by several people and on their surface bacteria and germs are settled and cultivated. According to the different reaction of the immune system of each human being, for various reasons, they may be the cause of serious illnesses that can lead to death in the weakest subjects; REGUITTI has invested in research and development recruiting specialized chemical staff, designating laboratories of research and exploring the panorama of antibacterial technologies to compare the different solutions found. This path has brought us to choose the technology with highest effectiveness and the lowest cost for the finished product.



HOW DOES IT WORK: The silver ions are slowly released from the Antigerm™ surface, inhibiting the growth of bacteria and causing almost their complete elimination (99.99%) The treatment has been certified from the British laboratories of the prestigious IMSL Ltd, in accordance with the regulations ISO 22196 (Determination of Antibacterial Activity). It prevents, fights and eliminates more than 650 species of bacteria, including the most popular and dangerous:
Eschelina coli,
Staphylococcus Aureus
Methicillin-resistant Staphylococcus aureus (MRSA)

DURATION: The activity of Antigerm™ treatment is permanent, throughout the useful life of the product, 24 hours per day and 7 days a week, without needing to be regenerated. Even with enhanced scratches on the surface, the silver ions have the ability to continue their influence ensuring the antibacterial activity as demonstrated by laboratory tests.

RESISTANCE OF SURFACE: resistance to salt corrosion: over 1,000 hours (+ 66% compared with polished lacquered finish); proof of accelerated wear resistance (abrasive friction*): more than 4 times the duration of polished lacquered finish without Antigerm™ treatment.

IDENTIFICATION: The handles with Antigerm™ coating are branded with the  logo, through a laser system that makes it indelible.

GLOBALITY, COMPLETENESS, AESTHETICS: Unlike other antibacterial surfaces and materials, Antigerm™ offers the advantage of being color-neutral and transparent, so it can be applied over any finish, leaving unchanged their tone and color.

WHY CHOOSING ANTIGERM™: we can affirm that Antigerm™, compared to bronze, titanium or galvanic silver coating, provides the higher antibacterial protection at the lowest price.

SENSITIVITY, RESPONSIBILITY, PRESTIGE: to prevent bacteria is a basic hygienic rule. Installing Antigerm™ is a demonstration of sensitivity and responsibility, especially to the weakest as children and elderly or sick people with weakened immunity defenses. For those who are responsible of facilities open to the public in general, installing Antigerm™ is a demonstration of responsibility for the public health. Advertising the use of Antigerm™ means to give more prestige to your facility/house.

www.antigerm.it

* Test report No. 149 of the Commission and Controls Product Testing Laboratory Reguitti SpA

LA PRIMA GAMMA DI MANIGLIE ANTIBATTERICHE CERTIFICATE THE FIRST RANGE OF CERTIFIED ANTIBACTERIAL HANDLES

LA MANIGLIA CHE CI PROTEGGE



THE HANDLE THAT **PROTECTS US**



FINITURE CON ANTIGERM DI SERIE

(SENZA AGGRAVIO DI EXTRA COSTO)

STANDARD FINISHES WITH ANTIGERM



BGO - AG+



AN - AG+



AGV - AG+



RX - AG+



NC - AG+



Coppia Maniglie

Pair handles

Coppia Pomolo

Knobsets

Pomolo Fisso

Single Knob

Dk - Cremonesi - Martelline

DK - Window Handles

Maniglioni singoli - Maniglioni per alzanti scorrevoli

Single Pull Handles - Pull Handles for sliding door

*Valido per finiture a richiesta con trattamento Antigerm

*Valid for finishes on request with Antigerm treatment

La prima gamma di maniglie e accessori con protezione antibatterica, completa e ricca, capace di soddisfare ogni tuo desiderio di bellezza e al tempo stesso di igiene.

Grazie a un trattamento esclusivo, AntiGerm garantisce l'eliminazione dei germi rendendo il mondo dove vivi più protetto e sicuro.

Ideale per situazioni dove l'igiene è un requisito fondamentale come ad esempio asili nido, scuole materne, ospedali, cliniche e case di cura, è anche altamente consigliabile per casa tua. Infatti AntiGerm è un trattamento possibile su ogni articolo Reguitti, che rende il tuo appartamento un luogo sano dove vivere.



AntiGerm uccide più del 99,99% dei germi. L'efficacia dell'azione antibatterica è stata scientificamente testata.

COME FUNZIONA?

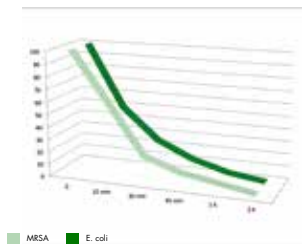

Grazie allo speciale trattamento AntiGerm gli ioni di argento vengono rilasciati lentamente uccidendo (o inibendo lo sviluppo) di batteri. Lo ione, assolutamente sicuro per l'uomo, penetra attraverso le pareti dell'organismo microbico, ne blocca la riproduzione attaccando il DNA, ed infine impedisce la respirazione della cellula. In pochi minuti possono essere in tal modo uccise oltre 650 specie batteriche tra cui Legionella, Escherichia Coli, Salmonella e MRSA. Le maniglie AntiGerm lavorano 24 ore al giorno 7 giorni su 7 riducendo il livello dei batteri di oltre il 99,99%, senza che tu debba fare assolutamente nulla. **La nostra salute inizia da ciò che tocchiamo.**

ANTIGERM È UN BRAND REGUITTI

REGUITTI®



Un'azienda nata nel 1975 e che nella sua storia è sempre stata attenta allo stile e alla ricerca e sviluppo. Il brand AntiGerm nasce dal voler offrire sempre prodotti innovativi in grado di dare qualcosa in più, senza rinunciare al design e a un'ampia offerta di finiture e accessori.

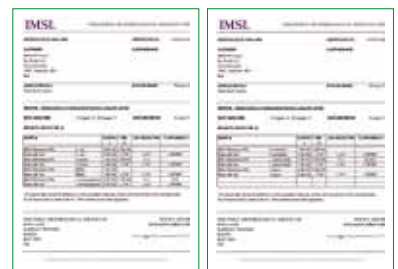

Prove di laboratorio effettuate dall'autorevole IMSL (Industrial Microbiological Services Ltd) secondo la norma ISO 22196, dimostrano l'efficacia di AntiGerm in grado di uccidere oltre 650 specie batteriche.

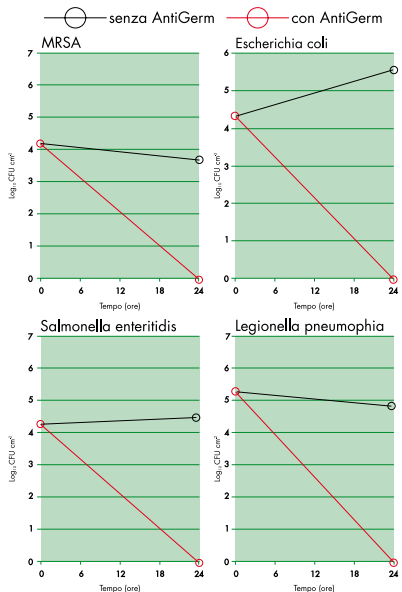



Gamma di maniglie per porte e finestre, disponibili con lo speciale trattamento AntigerM® agli ioni d'argento con prezzi di listino che non prevedono alcun addebito extra per il valore aggiunto.

Range of handles for doors and windows, available with the special treatment AntigerM® with silver ions.



art. 703



art. 175

Adeguamento tecnico della gamma di maniglie alle caratteristiche in uso nelle rispettive aree geografiche.

The handles are technically adequate to the characteristics used in different geographical areas.

SISTEMA EUROPEO
con fissaggio tramite
viti legno

EUROPEAN SYSTEM
fixed with wood screws

SISTEMA FRANCESE
con ferro q.7
FRENCH SYSTEM
with 7 mm spindle

SISTEMA TEDESCO
con fissaggio tramite viti
passanti inter.38 mm

GERMAN SYSTEM
with bolts screws through fixing
center to center 38 mm

SISTEMA SCANDINAVO
con fissaggio tramite
viti passanti inter.30 mm

SCANDINAVIAN SYSTEM
with bolts screws through fixing
center to center 30 mm

PER MAGGIORI INFORMAZIONI VISITATE
FOR MORE INFORMATION PLEASE VISIT

www.antigerm.it





Espositore da banco
Counter display



Depliant illustrativo
Illustrative leaflet



Adesivi per vetrofanie
Glass decals

IDENTIFICAZIONE DEL PRODOTTO PRODUCT IDENTIFICATION



Cartellino di certificazione
antibatterica
Antibacterial certification tag



Incisione laser
logo Antigerm
Antigerm Logo
laser engraving



Packaging con grafica
Antigerm
Packaging with Antigerm
graphics



COLLECTION

ottone antico
antique BRASS





40 MP 040



40 MP 026

REGUCCI®



40 MR 006



40 MR 004



40 MR R40



40 MR 202



40 MR 009



40 MR 007



411 NL

411 NT

411 NT

40 CR 063

411 NT

411 NL



410 AT



40 CR 040
40 MA 040



40 MA 007



OTTONE ANTICO
antique brass



40 DK 014



40 DK 015
40 DK 024



40 DK 075



40 DK C67





900 DK 014



900 DK 015



800 DK 014



800 DK C67



800 MP 040



900 MR 006



800 MR 006



900 MR 011

REGUZZI®



900 MP 040



800 MR 011



49 MP 026



49 MR R40



49 MR 007

destra/right



49 DK 015

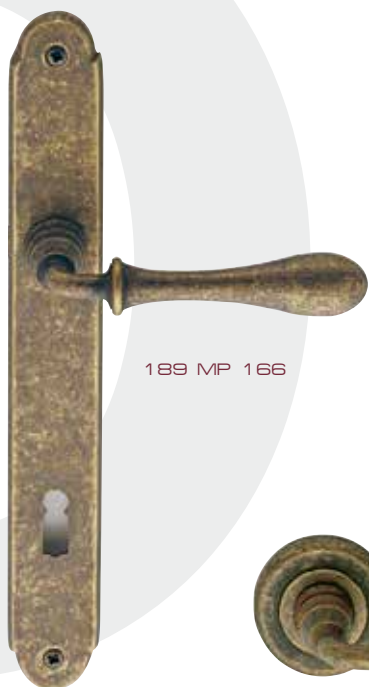

189 MP 166



189 CR 040
189 MA 040



189 DK 015



189 MR 006



189 MA 007



167 MR 202



OTTONE ANTICO
antique brass



167 MP 039



167 MR 004



167 DK 015



167 MA 007



167 CR 040
167 MA 040





190 CR 040
190 MA 040



191 MP 166



191 DK 015

411 NL



411 NT



411 NT



REGUZZI®



190 MA 007



410 AT

190 CR 063



411 NT



411 NL



190 TK 015



191 MR R40



191 MR 202



37 MP 037



37 CR 137
37 MA 137



37 DK 015



37 MR 006



OTTONE ANTICO
antique brass



94 MR 202



94 MR 011



73 MR 382



73 MR 311





69 MP 040 CHAMP/AN



69 MR 004 BN/AN



69 MA 007 CHAMP/AN



69 CR 040 CHAMP/AN
69 MA 040 CHAMP/AN

REGUZZI®



69 DK 014 BN/AN



69 DK 075 BN/AN



69 DK C67 BN/AN



69 DK 015 CHAMP/AN



174 MR 006 CHAMP/AN



174 MR 202 BN/AN



69 MR 011 BN/AN



69 MR 011 CHAMP/AN



69 MR 006 DEC.C/AN



69 MR 004 DEC.V/AN



69 MR 202 DEC.B/AN



69 MR 004 DEC.H/AN



53 PR 003 BN/AN



53 PR 006 DEC.C/AN



OTTONE ANTICO
antique brass



174 DK 015 CHAMP/AN



174 DK 014 CHAMP/AN



174 MP 039 BN/AN





172 MR 202 BN/AN



172 MR 004 BN/AN

172 DK 015 BN/AN

172 MP 040 CHAMP/AN



174 MP 040 CHAMP/AN

172 CR 040 BN/AN
172 MA 040 BN/AN

REGUZZI®



168 MR 202 BN/AN



168 MR 011 BN/AN



168 MR 009 BN/AN

168 DK 075 BN/AN

168 DK 014 BN/AN



T88 MP 026



80 MR 006



93 MR 207



137 MR 004



T88 MR 009



OTTONE ANTICO
antique brass



T36 MP 026

T36 MR 009

T33 MR 007



127 MR 008



67 MR R40



T42 MR 202



46 MR T36



46 CR 040
46 MA 040



46 MP 040



46 DK 015



46 MA 007

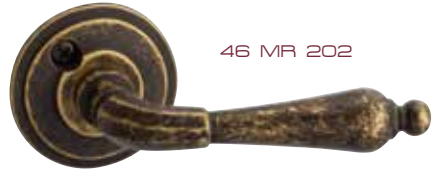

46 MR 202

REGUCCI®



166 MR 202



166 MP 166



166 MA 007



166 DK 015



166 CR 040
166 MA 040



40 MD R40



40 MS R40



339 MS 000



319 MS 006



OTTONE ANTICO
antique brass



313 MD 001



307 MD 001



30 MD 001





H56 PO 73R
H56 PF 73R



H57 PO 73R
H57 PF 73R



E60 PR 003

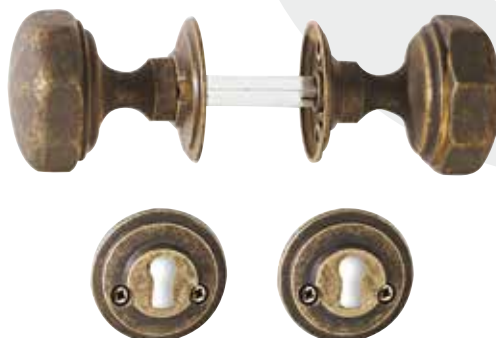

E60 PR 202

REGUZZI®



H60 PO 73R
H60 PF 73R



55 PR 009



N61 PO 73R
N61 PF 73R



48 PR 006



6 BA 73R



7 BA 73R



13 BA 73R



OTTONE ANTICO
antique brass



62 BY



7 BY



3 BY



202 BY



040 BY



6 BY



9 BY

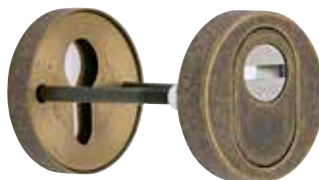

CD 002



CD 006



531 CA



305 PA



552 CI



20 CH TOO



21 CH



22 CH

REGUItti®



114 MT 096



503 NO 202



503 NO 003



120 PN



121 PN



122 PN



820 AN



821 AN



828 AN



829 AN



70 SP 007



63 SP 007



508 CP



519 CP



529 PI 002



524 PI 001



OTTONE ANTICO
antique brass



520 PI 002



514 CP



525 PI



506 CP 00A



FINITURA

€



SERIE MONIA



037 MP 037	Maniglia con placca 037 mm 255x42 con molla e grano	AN	•	1
037 MP 026	Maniglia con placca 026 mm 225x26 stretta con grano	AN	•	1
037 MR 004	Maniglia con rosetta 004 ø45x9 con molla e grano	AN	•	2
037 MR 006	Maniglia con rosetta 006 ø50x8 tipo lusso con molla e grano	AN	•	2
037 MR 007	Maniglia con rosetta 007 mm 67x27 ovale stretta con grano	AN	•	2
037 MR 009	Maniglia con rosetta 009 mm 62x32 ovale con molla e grano	AN	•	1
037 CR 137	Cremonese con placca 137 mm 167x40 con gioco	AN	•	2
037 MA 137	Martellina con placca 137 mm 167x40 q.7	AN	•	2
037 DK 015	Dreh Kipp con rosetta 015 mm 65x31 con movimento in metallo	AN	•	3
037 DK 024	Dreh Kipp c/rosetta 024 mm 65x31 c/mov. in metallo e quadro autoregolante	AN	•	3

SERIE GINEVRA



040 MP 040	Maniglia con placca 040 mm 244x40 con molla	AN	•	1
040 MP 040	Maniglia con placca 040 mm 244x40 con molla e grano	AN	•	1
040 MP 026	Maniglia con placca 026 mm 225x26 stretta con grano	AN	•	1
040 MR 004	Maniglia con rosetta 004 ø45x9 con molla e grano	AN	•	2
040 MR 006	Maniglia con rosetta 006 ø50x8 tipo lusso con molla e grano	AN	•	1
040 MR 007	Maniglia con rosetta 007 mm 67x27 ovale stretta con grano	AN	•	2
040 MR 009	Maniglia con rosetta 009 mm 62x32 ovale con molla e grano	AN	•	1
040 MR 202	Maniglia con rosetta 202 ø52x9 con bordo con grano	AN	•	2
040 MR R40	Maniglia con rosetta R40 ø45x7 con fori viti a vista con grano	AN	•	2
040 CR 040	Cremonese con placca 040 mm 174x37 con gioco	AN	•	2
040 CR 063	Cremonese con placca 063 mm 143x37 con gioco M.P. per aste esterne	AN	•	2
040 MA 007	Martellina con rosetta 007 mm 67x27 q.7	AN	•	2
040 MA 040	Martellina con placca 040 mm 174x37 q.7	AN	•	2
040 DK 014	Dreh Kipp con rosetta 014 mm 80x35 con movimento in metallo	AN	•	3
040 DK 015	Dreh Kipp con rosetta 015 mm 65x31 con movimento in metallo	AN	•	3
040 DK 024	Dreh Kipp c/rosetta 024 mm 65x31 c/mov. in metallo e quadro autoregolante	AN	•	3
040 DK C67	Dreh Kipp c/rosetta C67 mm 69x33 c/chiave e cilindro e mov. in metallo	AN	•	1
040 DK 075	Dreh Kipp c/rosetta 075 mm 64x30 con mov. securblock e puls. di sicurezza	AN	•	2

SERIE MARY

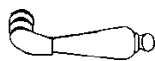

046 MP 040	Maniglia con placca 040 mm 244x40	AN	•	1
046 MP 026	Maniglia con placca 026 mm 225x26 stretta con grano	AN	•	1
046 MR 007	Maniglia con rosetta 007 mm 67x27 ovale stretta con grano	AN	•	2
046 MR 202	Maniglia con rosetta 202 ø52x9 con bordo con grano	AN	•	2
046 MR T36	Maniglia con rosetta T36 ø45x9 con bordo con grano	AN	•	2
046 CR 040	Cremonese con placca 040 mm 174x37 con gioco	AN	•	2
046 MA 040	Martellina con placca 040 mm 174x37 q.7	AN	•	2
046 MA 007	Martellina con rosetta 007 mm 67x27 q.7	AN	•	2
046 DK 015	Dreh Kipp con rosetta 015 mm 65x31 con movimento in metallo	AN	•	3

SERIE TOSCA









049 MP 166	Maniglia con placca 166 mm 242x33 con grano	AN	•	1
049 MP 040	Maniglia con placca 040 mm 244x40 con grano	AN	•	1
049 MP 026	Maniglia con placca 026 mm 225x26 stretta con grano	AN	•	1
049 MR 006	Maniglia con rosetta 006 ø50x8 tipo lusso con grano	AN	•	2
049 MR 007	Maniglia con rosetta 007 mm 67x27 ovale stretta con grano	AN	•	2
049 MR 202	Maniglia con rosetta 202 ø52x9 con bordo con grano	AN	•	2
049 MR R40	Maniglia con rosetta R40 ø45x7 con fori viti a vista con grano	AN	•	2
049 CR 040	Cremonese con placca 040 mm 174x37 con gioco	AN	•	2
049 MA 040	Martellina con placca 040 mm 174x37 q.7	AN	•	2
049 MA 007	Martellina con rosetta 007 mm 67x27 q.7	AN	•	2
049 DK 015	Dreh Kipp con rosetta 015 mm 65x31 con movimento in metallo	AN	•	3

SERIE PISA



067 MR 007	Maniglia con rosetta 007 mm 67x27 ovale stretta con grano	AN	•	2
067 MR R40	Maniglia con rosetta R40 ø45x7 con fori viti a vista	AN	•	2
067 MR T36	Maniglia con rosetta T36 ø45x9 con bordo con grano	AN	•	2
067 CR 040	Cremonese con placca 040 mm 174x37 con gioco	AN	•	2
067 MA 040	Martellina con placca 040 mm 174x37 q.7	AN	•	2
067 DK 015	Dreh Kipp con rosetta 015 mm 65x31 con movimento in metallo	AN	•	3

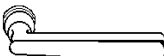
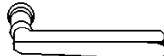

			FINITURA	€	
	SERIE BALTIC				
	073 MR 311	Maniglia con rosetta 311 ø53x10 tipo lusso con molla e grano	AN	•	1
	073 MR 382	Maniglia con rosetta 382 ø50x8 profilo a campana con molla e grano	AN	•	1
	SERIE CAPRI				
	080 MP 040	Maniglia con placca 040 mm 244x40 con molla e grano	AN	•	1
	080 MR 004	Maniglia con rosetta 004 ø45x9 con molla e grano	AN	•	2
	080 MR 006	Maniglia con rosetta 006 ø50x8 tipo lusso con molla e grano	AN	•	1
	SERIE NORDICA				
	093 MR 207	Maniglia con rosetta 207mm ø56 con grano	AN	•	1
	SERIE BERGEN				
	094 MP 039	Maniglia con placca 039 mm 255x50 con molla e grano	AN	•	1
	094 MR 004	Maniglia con rosetta 004 ø45x9 con molla e grano	AN	•	2
	094 MR 006	Maniglia con rosetta 006 ø50x8 tipo lusso con molla e grano	AN	•	1
	094 MR 202	Maniglia con rosetta 202 ø52x9 con bordo con grano	AN	•	2
	094 MR 011	Maniglia con rosetta 011 ø53x10 tipo lusso con molla e grano	AN	•	1
	SERIE LORY				
	127 MR 004	Maniglia con rosetta 008 ø50x8 con molla e grano	AN	•	2
	127 MR 006	Maniglia con rosetta 006 ø50x8 tipo lusso con molla e grano	AN	•	1
	127 MR 008	Maniglia con rosetta 008 ø50x8 con molla e grano	AN	•	1
	127 MR 009	Maniglia con rosetta 009 mm 62x32 ovale con molla e grano	AN	•	1
	127 DK 015	Dreh Kipp con rosetta 015 mm 65x31 con movimento in metallo	AN	•	3
	SERIE DESY				
	137 MR 004	Maniglia con rosetta 004 ø45x9 con molla e grano	AN	•	2
	137 MR 006	Maniglia con rosetta 006 ø50x8 tipo lusso con molla e grano	AN	•	2
	137 MR 007	Maniglia con rosetta 007 mm 67x27 ovale stretta con grano	AN	•	2
	137 MR 009	Maniglia con rosetta 009 mm 62x32 ovale con molla e grano	AN	•	1
	137 DK 015	Dreh Kipp con rosetta 015 mm 65x31 con movimento in metallo	AN	•	3
	SERIE PRAGA				
	166 MP 166	Maniglia con placca 166 mm 242x33 con molla e grano	AN	•	1
	166 MP 026	Maniglia con placca 026 mm 225x26 stretta con grano	AN	•	2
	166 MR 004	Maniglia con rosetta 004 ø45x9 con molla e grano	AN	•	2
	166 MR 006	Maniglia con rosetta 006 ø50x8 tipo lusso con molla e grano	AN	•	2
	166 MR 007	Maniglia con rosetta 007 mm 67x27 ovale stretta con grano	AN	•	2
	166 MR 009	Maniglia con rosetta 009 mm 62x32 ovale con molla e grano	AN	•	1
	166 MR 202	Maniglia con rosetta 202 ø52x9 con bordo con grano	AN	•	2
	166 CR 040	Cremonese con placca 040 mm 174x37 con gioco	AN	•	2
	166 MA 040	Martellina con placca 040 mm 174x37 q.7	AN	•	2
	166 MA 007	Martellina con rosetta 007 mm 67x27 q.7	AN	•	4
	166 DK 015	Dreh Kipp con rosetta 015 mm 65x31 con movimento in metallo	AN	•	3
	SERIE VIENNA				
	167 MP 039	Maniglia con placca 039 mm 255x50 con molla e grano	AN	•	1
	167 MP 040	Maniglia con placca 040 mm 244x40 con molla e grano	AN	•	1
	167 MP 026	Maniglia con placca 026 mm 225x26 stretta con grano	AN	•	1
	167 MR 004	Maniglia con rosetta 004 ø45x9 con molla e grano	AN	•	2
	167 MR 006	Maniglia con rosetta 006 ø50x8 tipo lusso con molla e grano	AN	•	2
	167 MR 007	Maniglia con rosetta 007 mm 67x27 ovale stretta con grano	AN	•	2
	167 MR 009	Maniglia con rosetta 009 mm 62x32 ovale con molla e grano	AN	•	1
	167 MR 202	Maniglia con rosetta 202 ø52x9 con bordo con grano	AN	•	2
	167 CR 040	Cremonese con placca 040 mm 174x37 con gioco	AN	•	2
	167 MA 040	Martellina con placca 040 mm 174x37 q.7	AN	•	2
	167 MA 007	Martellina con rosetta 007 mm 67x27 q.7	AN	•	2
	167 DK 015	Dreh Kipp con rosetta 015 mm 65x31 con movimento in metallo	AN	•	3

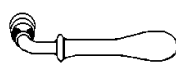

SERIE ROMEA

		FINITURA	€	
189 MP 040	Maniglia con placca 040 mm 244x40 con molla e grano	AN	•	1
189 MP 026	Maniglia con placca 026 mm 225x26 stretta con grano	AN	•	1
189 MP 166	Maniglia con placca 166 mm 242x33 con molla e grano	AN	•	1
189 MR 004	Maniglia con rosetta 004 ø45x9 con molla e grano	AN	•	2
189 MR 006	Maniglia con rosetta 006 ø50x8 tipo lusso con molla e grano	AN	•	2
189 MR 007	Maniglia con rosetta 007 mm 67x27 ovale stretta con grano	AN	•	2
189 MR 009	Maniglia con rosetta 009 mm 62x32 ovale con molla e grano	AN	•	1
189 MR 202	Maniglia con rosetta 202 ø52x9 con bordo con grano	AN	•	2
189 CR 040	Cremonese con placca 040 mm 174x37 con gioco	AN	•	2
189 MA 040	Martellina con placca 040 mm 174x37 q.7	AN	•	2
189 MA 007	Martellina con rosetta 007 mm 67x27 q.7	AN	•	4
189 DK 015	Dreh Kipp con rosetta 015 mm 65x31 con movimento in metallo	AN	•	3

SERIE OVALINO

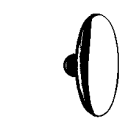

190 MA 040	Martellina con placca 040 mm 174x37 q.7	AN	•	2
190 MA 007	Martellina con rosetta 007 mm 67x27 q.7	AN	•	4
190 TK 015	Dreh Kipp con rosetta 015 mm 65x31 con impugnatura martellina a "T"	AN	•	2
190 CR 040	Cremonese con placca 040 mm 174x37 con gioco	AN	•	2
190 CR 063	Cremonese con placca 063 mm 143x37 con gioco M.P. per aste esterne	AN	•	2
410 AT 150	Asta mm 7x16 lunghezza cm.150	AN	•	12
410 AT 200	Asta mm 7x16 lunghezza cm.200	AN	•	12
411 NL ***	Solo finale mm 35x22	AN	•	50
411 NT ***	Solo passante mm 35x22	AN	•	50

SERIE OVALINO



191 MP 166	Maniglia con placca 166 mm 242x33 con molla e grano	AN	•	1
191 MP 026	Maniglia con placca 026 mm 225x26 stretta con grano	AN	•	1
191 MR 003	Maniglia con rosetta 003 ø45x7 con molla e grano	AN	•	2
191 MR 006	Maniglia con rosetta 006 ø50x8 tipo lusso con molla e grano	AN	•	2
191 MR 007	Maniglia con rosetta 007 mm 67x27 ovale stretta con grano	AN	•	2
191 MR 009	Maniglia con rosetta 009 mm 62x32 ovale con molla e grano	AN	•	1
191 MR 202	Maniglia con rosetta 202 ø52x9 con bordo con grano	AN	•	2
191 MR R40	Maniglia con rosetta R40 ø45x7 con fori viti a vista con grano	AN	•	2
191 DK 015	Dreh Kipp con rosetta 015 mm 65x31 con movimento in metallo	AN	•	3

SERIE EPOCA



800 MP 039	Maniglia con placca 039 mm 255x50 con molla e grano	AN	•	1
800 MP 040	Maniglia con placca 040 mm 244x40 con molla e grano	AN	•	1
800 MP 026	Maniglia con placca 026 mm 225x26 stretta con grano	AN	•	1
800 MR 004	Maniglia con rosetta 004 ø45x9 con molla e grano	AN	•	1
800 MR 006	Maniglia con rosetta 006 ø50x8 tipo lusso con molla e grano	AN	•	1
800 MR 011	Maniglia con rosetta 011 ø53x10 tipo lusso con molla e grano	AN	•	1
800 MR 916	Maniglia con rosetta 916 mm 62x32 ovale c/molla ambidestra e grano	AN	•	1
800 SG 040	Cremonese con placca 040 mm 174x37 con gioco	AN	•	2
800 SE 040	Martellina con placca 040 mm 174x37 q.7	AN	•	2
800 DK 014	Dreh Kipp con rosetta 014 mm 80x35 con movimento in metallo	AN	•	3
800 DK 015	Dreh Kipp con rosetta 015 mm 65x31 con movimento in metallo	AN	•	3
800 DK C67	Dreh Kipp c/rosetta C67 mm 69x33 c/chiave e cilindro e mov. in metallo	AN	•	1

SERIE CHARME



900 MP 039	Maniglia con placca 039 mm 255x50 con molla e grano	AN	•	1
900 MP 040	Maniglia con placca 040 mm 244x40 con molla e grano	AN	•	1
900 MP 026	Maniglia con placca 026 mm 225x26 stretta con grano	AN	•	1
900 MR 004	Maniglia con rosetta 004 ø45x9 con molla e grano	AN	•	1
900 MR 006	Maniglia con rosetta 006 ø50x8 tipo lusso con molla e grano	AN	•	1
900 MR 011	Maniglia con rosetta 011 ø53x10 tipo lusso con molla e grano	AN	•	1
900 MR 916	Maniglia con rosetta 916 mm 62x32 ovale c/molla ambidestra e grano	AN	•	1
900 SG 040	Cremonese con placca 040 mm 174x37 con gioco	AN	•	2
900 SE 040	Martellina con placca 040 mm 174x37 q.7	AN	•	2
900 DK 014	Dreh Kipp con rosetta 014 mm 80x35 con movimento in metallo	AN	•	3
900 DK 015	Dreh Kipp con rosetta 015 mm 65x31 con movimento in metallo	AN	•	3
900 DK C67	Dreh Kipp c/rosetta C67 mm 69x33 c/chiave e cilindro e mov. in metallo	AN	•	1



		FINITURA	€	
SERIE MIGNON				
	T33 MR 007	Maniglia con rosetta 007 mm 67x27 ovale stretta	AN	• 2
	T33 MR T33	Maniglia con rosetta T33 ø37x5 con bordo	AN	• 2
	T33 MA 007	Martellina con placca 040 mm 174x37 q.7	AN	• 3
	T33 DK 015	Dreh Kipp con rosetta 015 mm 65x31 con movimento in metallo	AN	• 2
SERIE TUSCANIA				
	T36 MP 026	Maniglia con placca 026 mm 225x26 stretta con grano	AN	• 1
	T36 MR 006	Maniglia con rosetta 006 ø50x8 tipo lusso con molla e grano	AN	• 1
	T36 MR 007	Maniglia con rosetta 007 mm 67x27 ovale stretta con grano	AN	• 2
	T36 MR 009	Maniglia con rosetta 009 mm 62x32 ovale con molla e grano	AN	• 1
	T36 MR T36	Maniglia con rosetta T36 ø45x9 con bordo con grano	AN	• 2
	T36 MA 040	Martellina con placca 040 mm 174x37 q.7	AN	• 2
	T36 CR 040	Cremonese con placca 040 mm 174x37 con gioco	AN	• 2
	T36 DK 015	Dreh Kipp con rosetta 015 mm 65x31 con movimento in metallo	AN	• 3
SERIE LUCCA				
	T42 MR 202	Maniglia con rosetta 202 ø52x9 con bordo con grano	AN	• 2
	T42 MR 007	Maniglia con rosetta 007 mm 67x27 ovale stretta con grano	AN	• 2
	T42 MR 009	Maniglia con rosetta 009 mm 62x32 ovale con molla e grano	AN	• 2
	T42 MR T36	Maniglia con rosetta T36 ø45x9 con bordo con grano	AN	• 3
	T42 DK 015	Dreh Kipp con rosetta 015 mm 65x31 con movimento in metallo	AN	• 3
SERIE ELBA				
	T88 MP 026	Maniglia con placca 026 mm 225x26 stretta con grano	AN	• 1
	T88 MP 039	Maniglia con placca 039 mm 255x50 con molla e grano	AN	• 1
	T88 MP 040	Maniglia con placca 040 mm 244x40 con molla e grano	AN	• 1
	T88 MR 006	Maniglia con rosetta 006 ø50x8 tipo lusso con molla e grano	AN	• 1
	T88 MR 007	Maniglia con rosetta 007 mm 67x27 ovale stretta con grano	AN	• 2
	T88 MR 009	Maniglia con rosetta 009 mm 62x32 ovale con molla e grano	AN	• 1
	T88 MR 202	Maniglia con rosetta 202 ø52x9 con bordo con grano	AN	• 2
	T88 MR 416	Maniglia con rosetta 416 ø45x9 con molla	AN	• 1
	T88 MR T36	Maniglia con rosetta T36 ø45x9 con bordo con grano	AN	• 2
	T88 SE 040	Martellina con placca 040 mm 174x37 q.7	AN	• 2
	T88 SG 040	Cremonese con placca 040 mm 174x37 con gioco	AN	• 2
	T88 DK 014	Dreh Kipp con rosetta 014 mm 80x35 con movimento in metallo	AN	• 3
	T88 DK 015	Dreh Kipp con rosetta 015 mm 65x31 con movimento in metallo	AN	• 3
	T88 DK 075	Dreh Kipp c/rosetta 075 mm 64x30 con mov. securblock e puls. di sicurezza	AN	• 2
POMOLO SERIE OVUM				
	048 PR 003	Coppia Pomolo ø60 con rosetta 003 ø45x7 con grano	AN	• 2
	048 PR 006	Coppia Pomolo con rosetta 006 ø50x8 tipo lusso con grano	AN	• 2
	048 PR 009	Coppia Pomolo con rosetta 009 mm 62x32 ovale con grano	AN	• 2
	048 PP 037	Coppia Pomolo con placca 037 mm 255x42 con grano	AN	• 1
	048 PF R50	Pomolo Fisso con rosetta R50 ø50x9 con piastrina	AN	• 4
	048 PF 006	Pomolo Fisso con rosetta 006 ø50x8 con piastrina	AN	• 4
	048 PF 009	Pomolo Fisso con rosetta 009 mm 62x32 ovale con piastrina	AN	• 4
	048 PF 037	Pomolo Fisso con placca 037 mm 255x42 yale	AN	• 2
POMOLO SERIE APOLLO				
	055 PR 004	Coppia Pomolo con rosetta 004 ø45x9 con molla e grano	AN	• 1
	055 PR 006	Coppia Pomolo con rosetta 006 ø50x8 tipo lusso con molla e grano	AN	• 1
	055 PR 009	Coppia Pomolo con rosetta 009 mm 62x32 ovale con molla e grano	AN	• 1
POMOLO SERIE COSMO				
	E56 PR 003	Coppia Pomolo ø60 con rosetta 003 ø45x7 con grano	AN	• 2
	E56 PR 006	Coppia Pomolo ø60 con rosetta 006 ø50x8 tipo lusso con grano	AN	• 2
	E56 PR 202	Coppia Pomolo ø60 con rosetta 202 ø52x9 con bordo con grano	AN	• 2
	E56 PO 73R	Pomolo Fisso ø60 con rosetta 73R ø72x9 con troncone filettato	AN	• 4
	H56 PO 73R	Pomolo Fisso ø75 con rosetta 73R ø72x9 con troncone filettato	AN	• 2
	E56 PF R50	Pomolo Fisso ø60 con rosetta R50 ø50x9 con piastrina	AN	• 4
	E56 PF 73R	Pomolo Fisso ø60 con rosetta 73R ø72x9 con piastrina	AN	• 4
	H56 PF R50	Pomolo Fisso ø75 con rosetta R50 ø50x9 con piastrina	AN	• 2
	H56 PF 73R	Pomolo Fisso ø75 con rosetta 73R ø72x9 con piastrina	AN	• 2



		FINITURA	€	
POMOLO SERIE MARGHERITA				
	E57 PR 003	Coppia Pomolo ø60 con rosetta 003 ø45x7 con grano	AN	• 2
	E57 PR 006	Coppia Pomolo ø60 con rosetta 006 ø50x8 tipo lusso con grano	AN	• 2
	E57 PR 202	Coppia Pomolo ø60 con rosetta 202 ø52x9 con bordo con grano	AN	• 2
	E57 PF 73R	Pomolo Fisso ø60 con rosetta 73R ø72x9 con piastrina	AN	• 4
	H57 PF 73R	Pomolo Fisso ø75 con rosetta 73R ø72x9 con piastrina	AN	• 2
	E57 PO 73R	Pomolo Fisso ø60 con rosetta 73R ø72x9 con troncone filettato	AN	• 4
	H57 PO 73R	Pomolo Fisso ø75 con rosetta 73R ø72x9 con troncone filettato	AN	• 2
POMOLO SERIE OTTAGONALE				
	E60 PR 003	Coppia Pomolo ø60 con rosetta 003 ø45x7 con grano	AN	• 2
	E60 PR 006	Coppia Pomolo ø60 con rosetta 006 ø50x8 tipo lusso con grano	AN	• 2
	E60 PR 202	Coppia Pomolo ø60 con rosetta 202 ø52x9 con bordo con grano	AN	• 2
	E60 PO 73R	Pomolo Fisso ø60 con rosetta 73R ø72x9 con troncone filettato	AN	• 4
	H60 PO 73R	Pomolo Fisso ø75 con rosetta 73R ø72x9 con troncone filettato	AN	• 2
	E60 PF R50	Pomolo Fisso ø60 con rosetta R50 ø50x9 con piastrina	AN	• 4
	E60 PF 73R	Pomolo Fisso ø60 con rosetta 73R ø72x9 con piastrina	AN	• 4
	H60 PF R50	Pomolo Fisso ø75 con rosetta R50 ø50x9 con piastrina	AN	• 2
	H60 PF 73R	Pomolo Fisso ø75 con rosetta 73R ø72x9 con piastrina	AN	• 2
	POMOLO SERIE ULISSE			
	N61 PO 73R	Pomolo Fisso ø90 con rosetta 73R ø72x9 con troncone filettato	AN	• 1
	N61 PF 73R	Pomolo Fisso ø90 con rosetta 73R ø72x9 con piastrina	AN	• 1
SET BOCCHETTE DI SICUREZZA				
	CD 002	"Set bocchette di sicurezza ø52 con protezione cilindro regolabile e 2 viti passanti M5-interasse mm.38 - completo di sottobocchetta in acciaio speciale temprato antitrapano"	AN	• 1
	CD 006	"Set bocchette di sicurezza ovali mm 92x35 con protezione cilindro regolabile e 2 viti passanti M6 - completo di sottobocchetta in acciaio speciale temprato antitrapano"	AN	• 1
MANIGLIONI				
	040 MD 003	Maniglione Diritto Singolo con rosetta 003 ø45x7	AN	• 2
	040 MD 006	Maniglione Diritto Singolo con rosetta 006 ø50x8 tipo lusso	AN	• 2
	040 MD 202	Maniglione Diritto Singolo con rosetta 202 ø52x9 con bordo	AN	• 2
	040 MD R40	Maniglione Diritto Singolo con rosetta R40 ø45x7 con fori viti a vista	AN	• 2
	040 MS 003	Maniglione Spostato Singolo con rosetta 003 ø45x7	AN	• 2
	040 MS 006	Maniglione Spostato Singolo con rosetta 006 ø50x8 tipo lusso	AN	• 2
	040 MS 202	Maniglione Spostato Singolo con rosetta 202 ø52x9 con bordo	AN	• 2
	040 MS R40	Maniglione Spostato Singolo con rosetta R40 ø45x7 con fori viti a vista	AN	• 2
	319 MS 006	Maniglione Spostato Singolo con rosetta 006 ø50x8 tipo lusso	AN	• 1
	338 MS 000	Maniglione Singolo	AN	• 1
339 MS 000	Maniglione Singolo	AN	• 1	
BATTENTI				
	006 BA 73R	Battente "Giove" con rosetta 73R ø72x9	AN	• 1
	007 BA 73R	Battente "Europa" con rosetta 73R ø72x9	AN	• 1
	013 BA 73R	Battente "Helios" con rosetta 73R ø72x9	AN	• 1
ARTICOLI VARI				
	003 BY ***	Bocchetta coprivite ø45 foro yale	AN	• 24
	006 BY ***	Bocchetta coprivite tipo lusso ø50 foro yale	AN	• 24
	007 BY ***	Bocchetta ovale stretta mm 67x27 foro yale	AN	• 24
	009 BY ***	Bocchetta coprivite ovale mm 62x32 foro yale	AN	• 24
	011 BY ***	Bocchetta coprivite tipo lusso ø53x10 foro yale	AN	•
	040 BY ***	Bocchetta per art. 040 ø45 foro yale	AN	• 24
	202 BY ***	Bocchetta ø52 con bordo foro yale	AN	• 24



			FINITURA	€	
	062 BY	Bocchetta coprivite mm 82 x 62 con foro yale	AN	•	24
	062 DM	Bocchetta coprivite mm 82 x 62 con doppia mappa	AN	•	24
	020 CH T00	Chiave tonda mm 85x26	AN	•	25
	022 CH ***	Chiave ovale mm 37x85	AN	•	25
	021 CH ***	Coprichiave universale con grano mm 45x30	AN	•	30
	531 CA ***	Copriavvolgibile universale	AN	•	12
	550 CI ***	Coprinterruttore "Ticino Magic" cieco o a 1 - 2 - 3 tasti	AN	•	12
	114 MT 096	Manettoncino int. Mm. 96 fil. 4MA	AN	•	12
	305 PA ***	Portabito mm.120x79	AN	•	12
				•	
	120 PN 035	Pomolino Ottagonale mm. 35	AN	•	24
	121 PN 022	Pomolino Spidy mm. 22	AN	•	24
	121 PN 028	Pomolino Spidy mm. 28	AN	•	24
	121 PN 034	Pomolino Spidy mm. 34	AN	•	24
	121 PN 040	Pomolino Spidy mm. 40	AN	•	24
	122 PN 020	Pomolino Sfera mm. 20	AN	•	24
	122 PN 025	Pomolino Sfera mm. 25	AN	•	24
	122 PN 030	Pomolino Sfera mm. 30	AN	•	24
	063 SP 007	Segretino piccolo con rosetta mm 67x27 q. 6/7/8	AN	•	12
	070 SP 007	Segretino piccolo con rosetta mm 67x27 q. 6/7/8	AN	•	12
	639 TV	Tavellino senza incontro	AN	•	50
	639 IN 005	Incontro per tavellino mm 5	AN	•	50
	639 IN 010	Incontro per tavellino mm 10	AN	•	50
	639 IN 015	Incontro per tavellino mm 15	AN	•	50
	639 IN 020	Incontro per tavellino mm 20	AN	•	50
	639 IN 025	Incontro per tavellino mm 25	AN	•	50
	639 IN 030	Incontro per tavellino mm 30	AN	•	50
	646 TV 000	Tavellino alt.00 a filo - senza incontro	AN	•	25
	646 TV 010	Tavellino mm.10 - senza incontro	AN	•	25
	646 TV 015	Tavellino mm.15 - senza incontro	AN	•	25
	646 TV 018	Tavellino mm.18 - senza incontro	AN	•	25
	646 TV 020	Tavellino mm.20 - senza incontro	AN	•	25
	646 TV 022	Tavellino mm.22 - senza incontro	AN	•	25
	646 TV 025	Tavellino mm.25 - senza incontro	AN	•	25
	646 TV 030	Tavellino mm.30 - senza incontro	AN	•	25
	646 IN	Incontro a filo per tavellino art.646	AN	•	25

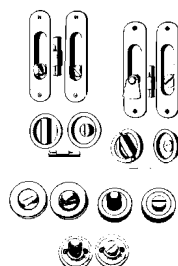

		FINITURA	€	
820 AN 013	Cappuccio per cerniera anuba ø13	AN	•	24
820 AN 014	Cappuccio per cerniera anuba ø14	AN	•	24
820 AN 016	Cappuccio per cerniera anuba ø16	AN	•	24
821 AN 014	Cappuccio per cerniera anuba ø14	AN	•	24
821 AN 016	Cappuccio per cerniera anuba ø16	AN	•	24
828 AN 013	Cappuccio per cerniera anuba ø13	AN	•	24
828 AN 014	Cappuccio per cerniera anuba ø14	AN	•	24
828 AN 016	Cappuccio per cerniera anuba ø16	AN	•	24
829 AN 014	Cappuccio per cerniera anuba ø14	AN	•	24
829 AN 016	Cappuccio per cerniera anuba ø16	AN	•	24

COPPIA PLACCHE INCASSO

506 CP 00A	Coppia placca incasso con nottolino alto q. 6/8	AN	•	4
508 CP ***	Coppia placca incasso con nottolino grande q. 6/8	AN	•	6
514 CP	Coppia placca incasso con nottolino pendente q. 6/8	AN	•	4
519 CP ***	Coppia placca incasso con nottolino ad anello q. 6/8	AN	•	6
503 NO 003	Nottolino libero/occupato per wc con rosetta coprivite ø45x7	AN	•	6
503 NO 006	Nottolino libero/occupato per wc con rosetta coprivite tipo lusso ø50x8	AN	•	6
503 NO 202	Nottolino libero/occupato per wc con rosetta ø52x9 con bordo con fori viti a vista	AN	•	6

MANIGLIONE ALZANTE ENEA



030 MD 001	Maniglione Diritto Singolo con placca cieca e con nicchia	AN	•	1
030 MD 010	Maniglione Diritto Singolo con placca yale e con nicchia	AN	•	1
030 LD 000	Coppia Maniglioni con placca yale, senza nicchia	AN	•	1

MANIGLIONE ALZANTE BERNINI

307 MD 001	Maniglione Diritto Singolo con placca cieca e con nicchia	AN	•	1
307 MD 010	Maniglione Diritto Singolo con placca yale e con nicchia	AN	•	1
307 LD 000	Coppia Maniglioni con placca yale, senza nicchia	AN	•	1

MANIGLIONE ALZANTE PRIAMO

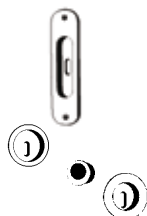
313 MD 001	Maniglione Diritto Singolo con placca cieca e con nicchia	AN	•	1
313 MD 010	Maniglione Diritto Singolo con placca yale e con nicchia	AN	•	1
313 LD 000	Coppia Maniglioni con placca yale, senza nicchia	AN	•	1
313 PI 002	Nicchia per Maniglione a scatto	AN	•	1

PLACCHE INCASSO

520 PI 001	Placca incasso mm 152x40 con foro chiave	AN	•	16
520 PI 002	Placca incasso mm 152x40 cieca	AN	•	16
524 PI 001	Placca incasso tonda ø57 incasso ø48 con foro chiave.	AN	•	24
524 PI 002	Placca incasso tonda ø57 incasso ø48 cieca	AN	•	24
525 PI	Frontalino di trascinamento ø29 incasso ø25	AN	•	24
529 PI 001	Placca incasso ø48 con bordo di presa con foro chiave.	AN	•	24
529 PI 002	Placca incasso ø48 con bordo di presa cieca	AN	•	24



SERIE CINZIA

		BN/AN	CHAMP/AN DEC.C/AN	DEC.H/AN DEC.B/AN DEC.V/AN	
069 MP 040	Maniglia con placca 040 mm 244x40 con molla e grano	•	•	•	1
069 MR 004	Maniglia con rosetta 004 ø45x9 con molla e grano	•	•	•	1
069 MR 006	Maniglia con rosetta 006 ø50x8 tipo lusso con molla e grano	•	•	•	1
069 MR 007	Maniglia con rosetta 007 mm 67x27 ovale stretta con grano	•	•	•	1
069 MR 011	Maniglia con rosetta 011 ø53x10 tipo lusso con molla e grano	•	•	•	1
069 MR 202	Maniglia con rosetta 202 ø52x9 con bordo con grano	•	•	•	1
069 CR 040	Cremonese con placca 040 mm 174x37 con gioco	•	•	-	2
069 MA 007	Maniglia con rosetta 007 mm 67x27 ovale stretta con grano	•	•	-	2
069 MA 040	Martellina con placca 040 mm 174x37 q.7	•	•	-	2
069 DK 014	Dreh Kipp con rosetta 014 mm 80x35 con movimento in metallo	•	•	•	3
069 DK 015	Dreh Kipp con rosetta 015 mm 65x31 con movimento in metallo	•	•	•	3
069 DK 075	Dreh Kipp c/rosetta 075 mm 64x30 con mov. securblock e puls. di sicurezza	•	•	•	2
069 DK C67	Dreh Kipp c/rosetta C67 mm 69x33 c/chave e cilindro e mov. in metallo	•	•	•	1

POMOLO



053 PR 003	Coppia Pomolo con rosetta 003 ø45x7 con grano	•	•	-	2
053 PR 006	Coppia Pomolo con rosetta 006 ø50x8 tipo lusso con grano	•	•	-	2
053 PR 202	Coppia Pomolo con rosetta 202 ø52x9 con bordo con grano	•	•	-	2
053 TK 015	Dreh Kipp con rosetta 015 mm 65x31 con impugnatura martellina a "T"	•	•	-	3
053 CR 040	Cremonese con placca 040 mm 174x37 con gioco	•	•	-	2
053 CR 137	Cremonese con placca 137 mm 167x40 con gioco	•	•	-	2
053 MA 040	Martellina con placca 040 mm 174x37 q.7	•	•	-	2
053 MA 137	Martellina con placca 137 mm 167x40 q.7	•	•	-	2
053 PP 040	Coppia Pomolo con placca 040 mm 244x40 con grano	•	•	-	1
053 PP 037	Coppia Pomolo con placca 037 mm 255x42 con grano	•	•	-	1

SERIE SANDRA



		BN/AN	
168 MP 039	Maniglia con placca 039 mm 255x50 con molla e grano	•	1
168 MP 040	Maniglia con placca 040 mm 244x40 con molla e grano	•	1
168 MR 004	Maniglia con rosetta 004 ø45x9 con molla e grano	•	1
168 MR 006	Maniglia con rosetta 006 ø50x8 tipo lusso con molla e grano	•	1
168 MR 007	Maniglia con rosetta 007 mm 67x27 ovale stretta con grano	•	1
168 MR 009	Maniglia con rosetta 009 mm 62x32 ovale con molla e grano	•	1
168 MR 011	Maniglia con rosetta 011 ø53x10 tipo lusso con molla e grano	•	1
168 MR 202	Maniglia con rosetta 202 ø52x9 con bordo con grano	•	1
168 CR 040	Cremonese con placca 040 mm 174x37 con gioco	•	2
168 MA 040	Martellina con placca 040 mm 174x37 q.7	•	2
168 DK 014	Dreh Kipp con rosetta 014 mm 80x35 con movimento in metallo	•	3
168 DK 015	Dreh Kipp con rosetta 015 mm 65x31 con movimento in metallo	•	3
168 DK 075	Dreh Kipp c/rosetta 075 mm 64x30 con mov. securblock e puls. di sicurezza	•	2



SERIE HANSEL

		BN/AN	CHAMP/AN	
172 MP 040	Maniglia con placca 040 mm 244x40 con molla e grano	52,61	•	1
172 MP 039	Maniglia con placca 039 mm 255x50 con molla e grano	61,02	•	1
172 MR 004	Maniglia con rosetta 004 ø45x9 con molla e grano	51,27	•	1
172 MR 006	Maniglia con rosetta 006 ø50x8 tipo lusso con molla e grano	63,13	•	1
172 MR 202	Maniglia con rosetta 202 ø52x9 con bordo con grano	49,19	•	1
172 CR 040	Cremonese con placca 040 mm 174x37 con gioco	28,50	•	2
172 MA 040	Martellina con placca 040 mm 174x37 q.7	27,23	•	2
172 DK 015	Dreh Kipp con rosetta 015 mm 65x31 con movimento in metallo	30,22	•	3

SERIE GRETEL

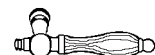

174 MP 040	Maniglia con placca 040 mm 244x40 con molla e grano	52,61	•	1
174 MP 039	Maniglia con placca 039 mm 255x50 con molla e grano	61,02	•	1
174 MR 004	Maniglia con rosetta 004 ø45x9 con molla e grano	51,27	•	1
174 MR 006	Maniglia con rosetta 006 ø50x8 tipo lusso con molla e grano	63,13	•	1
174 MR 202	Maniglia con rosetta 202 ø52x9 con bordo con grano	49,19	•	1
174 SG 040	Segretino con impugnatura a maniglia con placca 040 mm 174x37 c/ gioco	28,50	•	2
174 SE 040	Segretino con impugnatura a maniglia con placca 040 mm 174x37 q.7	27,23	•	2
174 DK 014	Dreh Kipp con rosetta 014 mm 80x35 con movimento in metallo	35,22	•	3
174 DK 015	Dreh Kipp con rosetta 015 mm 65x31 con movimento in metallo	30,22	•	3



Il trattamento speciale subito dal prodotto può causare piccole variazioni di tonalità nella finitura, non imputabili a difetto, bensì alla ricerca dell'ottenimento del migliore effetto di invecchiamento.

The special treatment of these products can lead to a small color variations on finish, that enhances its Vintage features.

ARGENTO VECCHIO
OLD SILVER

COLLECTION



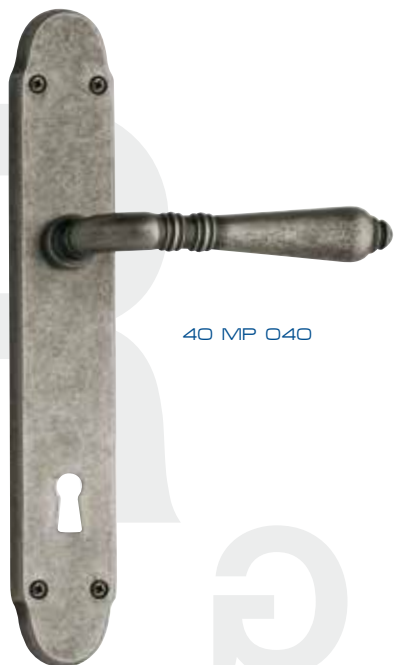

40 MP 040



40 CR 040
40 MA 040



40 DK 015
40 DK 024



40 DK 075



40 DK 014

REGUETTI®



40 MR 003



40 MR 202



40 MR 007



189 CR 040
189 MA 040



189 DK C67



189 DK 015



189 MR 006



ARGENTO **VECCHIO**
old silver



40 MD 202



307 MD



40 MS 202

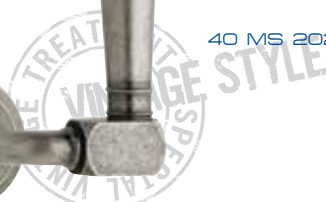



800 MR 006



900 MR 006



800 MR 011

REGUITTI®



900 DK C67



800 DK 015



900 DK 014



800 DK 014



49 MR R40

destra/right



49 MR 007



49 MA 007



49 DK 015



191 MP 166



190 CR 040
190 MA 040



191 DK 015



411 NL



411 NT



411 NT



190 CR 063



411 NT



411 NL



410 AT



ARGENTO **VECCHIO**
oldsilver



191 MR 003



191 MR 202





69 MP 040 CHAMP/AGV



69 CR 040 CHAMP/AGV
69 MA 040 CHAMP/AGV



69 DK 015 CHAMP/AGV

REGUETTI®



53 PR 202 CHAMP/AGV



69 MR 202 CHAMP/AGV





69 MP 040 BN/AGV



69 DK 015 DEC. C/AGV



69 DK 014 BN/AGV



ARGENTO **VECCHIO**
old silver



53 PR 003 BN/AGV



69 MR 003 NR/AGV





46 MP 040



46 CR 040
46 MA 040



46 DK 015



46 MR T36



46 MR 202



REGUETTI®



167 MP 039



167 MP 040



167 DK 015



167 MR 202





94 MP 039

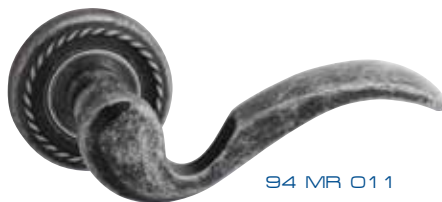

94 MR 011



94 MR 202



73 MR 311



ARGENTO **VECCHIO**
oldsilver



73 MR 382



3 BY



6 BY



188 MR 382



202 BY



7 BY





H56 PO 73R
H56 PF 73R



E56 PR 003



H57 PO 73R
H57 PF 73R

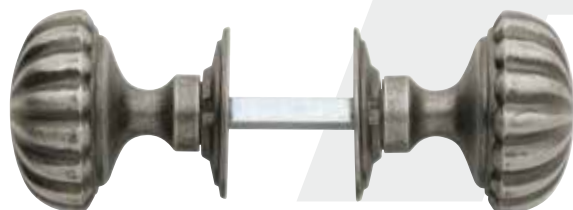

E57 PR 202



REGUZZI®

55 PR 003



7 BA 73R



13 BA 73R



531 CA



829 AN



828 AN



305 PA



20 CH TOO



552 CI



21 CH



22 CH



ARGENTO **VECCHIO**
old silver



121 PN



122 PN



70 SP 007



646 IN

646 TV



114 MT 096





520 PI 002



508 CP



519 CP

REGUETTI®



503 NO 003



525 PI



524 PI 001



524 PI 002



339 MS 000



137 MR 006



93 MR 207



T88 MR 009



127 MR 008



ARGENTOVICCHIO
T36 DK 015 oldsilver



T33 SP 007



T36 MR 007



T36 DK 075



T33 MR T33





		FINITURA	€	
SERIE GINEVRA				
040 MP 040	Maniglia con placca 040 mm 244x40 con molla	AGV	•	1
040 MP 040	Maniglia con placca 040 mm 244x40 Con molla e grano	AGV	•	1
040 MP 026	Maniglia con placca 026 mm 225x26 stretta con grano	AGV	•	1
040 MR 003	Maniglia con rosetta 003 ø45x7 con molla e grano	AGV	•	2
040 MR 006	Maniglia con rosetta 006 ø50x8 tipo lusso con molla e grano	AGV	•	2
040 MR 007	Maniglia con rosetta 007 mm 67x27 ovale stretta con grano	AGV	•	2
040 MR 202	Maniglia con rosetta 202 ø52x9 con bordo con grano	AGV	•	2
040 CR 040	Cremonese con placca 040 mm 174x37 con gioco	AGV	•	2
040 MA 007	Martellina con rosetta 007 mm 67x27 q.7	AGV	•	2
040 MA 040	Martellina con placca 040 mm 174x37 q.7	AGV	•	2
040 DK 014	Dreh Kipp con rosetta 014 mm 80x35 con movimento in metallo	AGV	•	3
040 DK 015	Dreh Kipp con rosetta 015 mm 65x31 con movimento in metallo	AGV	•	3
040 DK 024	Dreh Kipp c/rosetta 024 mm 65x31 c/mov. in metallo e quadro autoregolante	AGV	•	3
040 DK 075	Dreh Kipp c/rosetta 075 mm 64x30 con mov. securblock e puls. di sicurezza	AGV	•	2
040 DK C67	Dreh Kipp c/rosetta C67 mm 69x33 c/chiave e cilindro e mov. in metallo	AGV	•	1



SERIE RITA				
043 MP 040	Maniglia con placca 040 mm 244x40 con grano	AGV	•	1
043 MP 026	Maniglia con placca 026 mm 225x26 stretta con grano	AGV	•	1
043 MR 007	Maniglia con rosetta 007 mm 67x27 ovale stretta con grano	AGV	•	2
043 MR 202	Maniglia con rosetta 202 ø52x9 con bordo con grano	AGV	•	2
043 CR 040	Cremonese con placca 040 mm 174x37 con gioco	AGV	•	2
043 MA 040	Martellina con placca 040 mm 174x37 q.7	AGV	•	2
043 DK 015	Dreh Kipp con rosetta 015 mm 65x31 con movimento in metallo	AGV	•	3



SERIE MARY				
046 MP 040	Maniglia con placca 040 mm 244x40	AGV	•	1
046 MP 026	Maniglia con placca 026 mm 225x26 stretta con grano	AGV	•	1
046 MR 007	Maniglia con rosetta 007 mm 67x27 ovale stretta con grano	AGV	•	2
046 MR 202	Maniglia con rosetta 202 ø52x9 con bordo con grano	AGV	•	2
046 MR T36	Maniglia con rosetta T36 ø45x9 con bordo con grano	AGV	•	2
046 CR 040	Cremonese con placca 040 mm 174x37 con gioco	AGV	•	2
046 MA 040	Martellina con placca 040 mm 174x37 q.7	AGV	•	2
046 DK 015	Dreh Kipp con rosetta 015 mm 65x31 con movimento in metallo	AGV	•	3



SERIE TOSCA				
049 MP 166	Maniglia con placca 166 mm 242x33 con grano	AGV	•	1
049 MP 040	Maniglia con placca 040 mm 244x40 con grano	AGV	•	1
049 MP 026	Maniglia con placca 026 mm 225x26 stretta con grano	AGV	•	1
049 MR 006	Maniglia con rosetta 006 ø50x8 tipo lusso con grano	AGV	•	2
049 MR 007	Maniglia con rosetta 007 mm 67x27 ovale stretta con grano	AGV	•	2
049 MR 202	Maniglia con rosetta 202 ø52x9 con bordo con grano	AGV	•	2
049 MR R40	Maniglia con rosetta R40 ø45x7 con fori viti a vista con grano	AGV	•	2
049 CR 040	Cremonese con placca 040 mm 174x37 con gioco	AGV	•	2
049 MA 040	Martellina con placca 040 mm 174x37 q.7	AGV	•	2
049 MA 007	Martellina con rosetta 007mm 67x27 q.7	AGV	•	2
049 DK 015	Dreh Kipp con rosetta 015 mm 65x31 con movimento in metallo	AGV	•	3



SERIE BALTIC				
073 MR 311	Maniglia con rosetta 311 ø53x10 tipo lusso con molla e grano	AGV	•	1
073 MR 382	Maniglia con rosetta 382 ø50x8 profilo a campana con molla e grano	AGV	•	1



SERIE NORDICA				
093 MR 207	Maniglia con rosetta 207 ø56 con grano	AGV	•	1

SERIE BERGEN

			FINITURA	€	
094 MP 039	Maniglia con placca 039 mm 255x50 con molla e grano	AGV	•	1	
094 MR 004	Maniglia con rosetta 004 ø45x9 con molla e grano	AGV	•	2	
094 MR 006	Maniglia con rosetta 006 ø50x8 tipo lusso con molla e grano	AGV	•	2	
094 MR 011	Maniglia con rosetta 011 ø53x10 tipo lusso con molla e grano	AGV	•	2	
094 MR 202	Maniglia con rosetta 202 ø52x9 con bordo con grano	AGV	•	2	
094 DK 015	Dreh Kipp con rosetta 015 mm 65x31 con movimento in metallo	AGV	•	3	

SERIE LORY



127 MR 006	Maniglia con rosetta 006 ø50x8 tipo lusso con molla e grano	AGV	•	1	
127 MR 008	Maniglia con rosetta 008 ø50x8 con molla e grano	AGV	•	2	
127 MR 009	Maniglia con rosetta 009 mm 62x32 ovale con molla e grano	AGV	•	1	
127 DK 015	Dreh Kipp con rosetta 015 mm 65x31 con movimento in metallo	AGV	•	3	

SERIE DESY

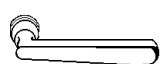

137 MR 006	Maniglia con rosetta 006 ø50x8 tipo lusso con molla e grano	AGV	•	2	
137 DK 015	Dreh Kipp con rosetta 015 mm 65x31 con movimento in metallo	AGV	•	3	

SERIE AUXILIUM

188 MR 382	Maniglia con rosetta 382 ø50x8 profilo a campana con molla e grano	AGV	•	1	
------------	--	-----	---	---	--

SERIE PRAGA

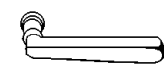
166 MP 166	Maniglia con placca 166 mm 242x33 con molla e grano	AGV	•	1	
166 MP 026	Maniglia con placca 026 mm 225x26 stretta con grano	AGV	•	2	
166 MR 004	Maniglia con rosetta 004 ø45x9 con molla e grano	AGV	•	2	
166 MR 006	Maniglia con rosetta 006 ø50x8 tipo lusso con molla e grano	AGV	•	2	
166 MR 007	Maniglia con rosetta 007 mm 67x27 ovale stretta con grano	AGV	•	2	
166 MR 009	Maniglia con rosetta 009 mm 62x32 ovale con molla e grano	AGV	•	1	
166 MR 202	Maniglia con rosetta 202 ø52x9 con bordo con grano	AGV	•	2	
166 CR 040	Cremonese con placca 040 mm 174x37 con gioco	AGV	•	2	
166 MA 040	Martellina con placca 040 mm 174x37 q.7	AGV	•	2	
166 MA 007	Martellina con rosetta 007 mm 67x27 q.7	AGV	•	4	
166 DK 015	Dreh Kipp con rosetta 015 mm 65x31 con movimento in metallo	AGV	•	3	

SERIE VIENNA

167 MP 039	Maniglia con placca 039 mm 255x50 con molla e grano	AGV	•	1	
167 MP 040	Maniglia con placca 040 mm 244x40 con molla e grano	AGV	•	1	
167 MR 006	Maniglia con rosetta 006 ø50x8 tipo lusso con molla e grano	AGV	•	2	
167 MR 202	Maniglia con rosetta 202 ø52x9 con bordo con grano	AGV	•	2	
167 CR 040	Cremonese con placca 040 mm 174x37 con gioco	AGV	•	2	
167 MA 040	Martellina con placca 040 mm 174x37 q.7	AGV	•	2	
167 DK 015	Dreh Kipp con rosetta 015 mm 65x31 con movimento in metallo	AGV	•	3	

SERIE ROMEA

189 MP 040	Maniglia con placca 040 mm 244x40 con molla e grano	AGV	•	1	
189 MP 026	Maniglia con placca 026 mm 225x26 stretta con grano	AGV	•	1	
189 MP 166	Maniglia con placca 166 mm 242x33 con molla e grano	AGV	•	1	
189 MR 004	Maniglia con rosetta 004 ø45x9 con molla e grano	AGV	•	2	
189 MR 006	Maniglia con rosetta 006 ø50x8 tipo lusso con molla e grano	AGV	•	2	
189 MR 007	Maniglia con rosetta 007 mm 67x27 ovale stretta con grano	AGV	•	2	
189 MR 009	Maniglia con rosetta 009 mm 62x32 ovale con molla e grano	AGV	•	1	
189 MR 202	Maniglia con rosetta 202 ø52x9 con bordo con grano	AGV	•	2	
189 CR 040	Cremonese con placca 040 mm 174x37 con gioco	AGV	•	2	
189 MA 040	Martellina con placca 040 mm 174x37 q.7	AGV	•	2	
189 MA 007	Martellina con rosetta 007 mm 67x27 q.7	AGV	•	4	
189 DK 015	Dreh Kipp con rosetta 015 mm 65x31 con movimento in metallo	AGV	•	3	
189 DK C67	Dreh Kipp c/rosetta C67 mm 69x33 c/chiave e cilindro e mov. in metallo	AGV	•	1	

SERIE OVALINO

191 MP 166	Maniglia con placca 166 mm 242x33 con molla e grano	AGV	•	1	
191 MR 003	Maniglia con rosetta 003 ø45x7 con molla e grano	AGV	•	2	
191 MR 202	Maniglia con rosetta 202 ø52x9 con bordo con grano	AGV	•	2	
191 DK 015	Dreh Kipp con rosetta 015 mm 65x31 con movimento in metallo	AGV	•	3	

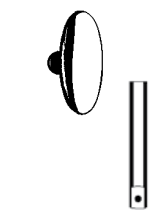

		FINITURA	€	
SERIE OVALINO				
	190 MA 040	Martellina con placca 040 mm 174x37 q.7	AGV	• 2
	190 MA 007	Martellina con rosetta 007 mm 67x27 q.7	AGV	• 4
	190 TK 015	Dreh Kipp con rosetta 015 mm 65x31 con impugnatura martellina a "T"	AGV	• 3
	190 CR 040	Cremonese con placca 040 mm 174x37 con gioco	AGV	• 2
	190 CR 063	Cremonese con placca 063 mm 143x37 con gioco M.P. per aste esterne	AGV	• 2
	410 AT 150	Asta mm 7x16 lunghezza cm 150	AGV	• 12
	410 AT 200	Asta mm 7x16 lunghezza cm 200	AGV	• 12
	411 NL ***	Solo finale mm 35x22	AGV	• 50
	411 NT ***	Solo passante mm 35x22	AGV	• 50
SERIE EPOCA				
	800 MP 039	Maniglia con placca 039 mm 255x50 con molla e grano	AGV	• 1
	800 MP 040	Maniglia con placca 040 mm 244x40 con molla e grano	AGV	• 1
	800 MP 026	Maniglia con placca 026 mm 225x26 stretta con grano	AGV	• 1
	800 MR 004	Maniglia con rosetta 004 ø45x9 con molla e grano	AGV	• 1
	800 MR 006	Maniglia con rosetta 006 ø50x8 tipo lusso con molla e grano	AGV	• 1
	800 MR 011	Maniglia con rosetta 011 ø53x10 tipo lusso con molla e grano	AGV	• 1
	800 MR 202	Maniglia con rosetta 202 ø52x9 con bordo con grano	AGV	• 1
	800 MR 916	Maniglia con rosetta 916 mm 62x32 ovale c/molla ambidestra e grano	AGV	• 1
	800 SG 040	Cremonese con placca 040 mm 174x37 con gioco	AGV	• 2
	800 SE 040	Martellina con placca 040 mm 174x37 q.7	AGV	• 2
	800 DK 014	Dreh Kipp con rosetta 014 mm 80x35 con movimento in metallo	AGV	• 3
	800 DK 015	Dreh Kipp con rosetta 015 mm 65x31 con movimento in metallo	AGV	• 3
	800 DK C67	Dreh Kipp c/rosetta C67 mm 69x33 c/chiave e cilindro e mov. in metallo	AGV	• 1
SERIE CHARME				
	900 MP 039	Maniglia con placca 039 mm 255x50 con molla e grano	AGV	• 1
	900 MP 040	Maniglia con placca 040 mm 244x40 con molla e grano	AGV	• 1
	900 MP 026	Maniglia con placca 026 mm 225x26 stretta con grano	AGV	• 1
	900 MR 004	Maniglia con rosetta 004 ø45x9 con molla e grano	AGV	• 1
	900 MR 006	Maniglia con rosetta 006 ø50x8 tipo lusso con molla e grano	AGV	• 1
	900 MR 202	Maniglia con rosetta 202 ø52x9 con bordo con grano	AGV	• 1
	900 MR 916	Maniglia con rosetta 916 mm 62x32 ovale c/molla ambidestra e grano	AGV	• 1
	900 SG 040	Cremonese con placca 040 mm 174x37 con gioco	AGV	• 2
	900 SE 040	Martellina con placca 040 mm 174x37 q.7	AGV	• 2
	900 DK 014	Dreh Kipp con rosetta 014 mm 80x35 con movimento in metallo	AGV	• 3
	900 DK 015	Dreh Kipp con rosetta 015 mm 65x31 con movimento in metallo	AGV	• 3
	900 DK C67	Dreh Kipp c/rosetta C67 mm 69x33 c/chiave e cilindro e mov. in metallo	AGV	• 1
SERIE MIGNON				
	T33 MR 007	Maniglia con rosetta 007 mm 67x27 ovale stretta	AGV	• 2
	T33 MR T33	Maniglia con rosetta T33 ø37x5 con bordo	AGV	• 2
	T33 MA 007	Martellina su rosetta 007 mm 67x27 q.7	AGV	• 2
	T33 MA T33	Martellina su rosetta T33 mm ø37x5 q.7	AGV	• 2
	T33 SP 007	Segretino con rosetta 007 mm 67x27 ovale stretta	AGV	• 12
	T33 TK 015	Dreh kipp con rosetta 015 mm 65x31 con impugnatura martellina a "T"	AGV	• 3
SERIE TUSCANIA				
	T36 MR 006	Maniglia con rosetta 006 ø50x8 tipo lusso con molla e grano	AGV	• 1
	T36 MR 007	Maniglia con rosetta 007 mm 67x27 ovale stretta con grano	AGV	• 2
	T36 MR T36	Maniglia con rosetta T36 mm ø45x9 con bordo	AGV	• 2
	T36 DK 015	Dreh Kipp con rosetta 015 mm 65x31 con movimento in metallo	AGV	• 3
	T36 DK 075	Dreh Kipp c/rosetta 075 mm 64x30 con mov. securblock e puls. di sicurezza	AGV	• 2
SERIE ELBA				
	T88 MR 006	Maniglia con rosetta 006 ø50x8 tipo lusso con molla e grano	AGV	• 1
	T88 MR 007	Maniglia con rosetta 007 mm 67x27 ovale stretta con grano	AGV	• 2
	T88 MR 009	Maniglia con rosetta 009 mm 62x32 ovale con molla e grano	AGV	• 1
	T88 MR 202	Maniglia con rosetta 202 ø52x9 con bordo con grano	AGV	• 2
	T88 MR T36	Maniglia con rosetta T36 mm ø45x9 con bordo	AGV	• 2
	T88 DK 015	Dreh Kipp con rosetta 015 mm 65x31 con movimento in metallo	AGV	• 3
	T88 DK 075	Dreh Kipp c/rosetta 075 mm 64x30 con mov. securblock e puls. di sicurezza	AGV	• 2



			FINITURA	€	
POMOLO SERIE APOLLO					
	055 PR 003	Coppia Pomolo con rosetta 003 ø45x7 con molla e grano	AGV	•	1
	055 PR 006	Coppia Pomolo con rosetta 006 ø50x8 tipo lusso con molla e grano	AGV	•	1
POMOLO SERIE COSMO					
	E56 PR 003	Coppia Pomolo ø60 con rosetta 003 ø45x7 con grano	AGV	•	2
	E56 PR 006	Coppia Pomolo ø60 con rosetta 006 ø50x8 tipo lusso con grano	AGV	•	2
	E56 PR 202	Coppia Pomolo ø60 con rosetta 202 ø52x9 con bordo con grano	AGV	•	2
	E56 PO 73R	Pomolo Fisso ø60 con rosetta 73R ø72x9 con troncone filettato	AGV	•	4
	H56 PO 73R	Pomolo Fisso ø75 con rosetta 73R ø72x9 con troncone filettato	AGV	•	2
	E56 PF 006	Pomolo Fisso ø60 con rosetta 006 ø50X8	AGV	•	1
	E56 PF 73R	Pomolo Fisso ø60 con rosetta 73R ø72x9 con piastrina	AGV	•	4
	H56 PF 73R	Pomolo Fisso ø75 con rosetta 73R ø72x9 con piastrina	AGV	•	2
POMOLO SERIE MARGHERITA					
	E57 PR 003	Coppia Pomolo ø60 con rosetta 003 ø45x7 con grano	AGV	•	2
	E57 PR 006	Coppia Pomolo ø60 con rosetta 006 ø50x8 tipo lusso con grano	AGV	•	2
	E57 PR 202	Coppia Pomolo ø60 con rosetta 202 ø52x9 con bordo con grano	AGV	•	2
	E57 PO 73R	Pomolo Fisso ø60 con rosetta 73R ø72x9 con troncone filettato	AGV	•	4
	H57 PO 73R	Pomolo Fisso ø75 con rosetta 73R ø72x9 con troncone filettato	AGV	•	2
	E57 PF 73R	Pomolo Fisso ø60 con rosetta 73R ø72x9 con piastrina	AGV	•	4
	H57 PF 73R	Pomolo Fisso ø75 con rosetta 73R ø72x9 con piastrina	AGV	•	2
POMOLO SERIE ULISSE					
	N61 PO 73R	Pomolo Fisso ø90 con rosetta 73R ø72x9 con troncone filettato	AGV	•	1
	N61 PF 73R	Pomolo Fisso ø90 con rosetta 73R ø72x9 con piastrina	AGV	•	1
MANIGLIONE SERIE GINEVRA					
	040 MD 003	Maniglione Diritto Singolo con rosetta 003 ø45x7	AGV	•	2
	040 MD 006	Maniglione Diritto Singolo con rosetta 006 ø50x8 tipo lusso	AGV	•	2
	040 MD 202	Maniglione Diritto Singolo con rosetta 202 ø52x9 con bordo	AGV	•	2
	040 MS 003	Maniglione Spostato Singolo con rosetta 003 ø45x7	AGV	•	2
	040 MS 006	Maniglione Spostato Singolo con rosetta 006 ø50x8 tipo lusso	AGV	•	2
	040 MS 202	Maniglione Spostato Singolo con rosetta 202 ø52x9 con bordo	AGV	•	2
	338 MS 000	Maniglione singolo	AGV	•	1
	339 MS 000	Maniglione singolo	AGV	•	1
SET BOCCHETTE DI SICUREZZA					
	CD 002	"Set bocchette di sicurezza ø52 con protezione cilindro regolabile e 2 viti passanti M5-interasse mm.38 - completo di sottobocchetta in acciaio speciale temprato antitrapano"	AGV	•	1
	CD 006	"Set bocchette di sicurezza ovali mm 92x35 con protezione cilindro regolabile e 2 viti passanti M6 - completo di sottobocchetta in acciaio speciale temprato antitrapano"	AGV	•	1
BATTENTI					
	006 BA 73R	Battente "Giove" con rosetta 73R ø72x9	AGV	•	1
	007 BA 73R	Battente "Europa" con rosetta 73R ø72x9	AGV	•	1
	013 BA 73R	Battente "Helios" con rosetta 73R ø72x9	AGV	•	1
MANIGLIONE ALZANTE ENEA					
	030 MD 001	Maniglione Diritto Singolo con placca cieca e con nicchia	AGV	•	1
	030 MD 010	Maniglione Diritto Singolo con placca yale e con nicchia	AGV	•	1
	030 LD 000	Coppia Maniglioni con placca yale, senza nicchia	AGV	•	1
MANIGLIONE ALZANTE BERNINI					
	307 MD 001	Maniglione Diritto Singolo con placca cieca e con nicchia	AGV	•	1
	307 MD 010	Maniglione Diritto Singolo con placca yale e con nicchia	AGV	•	1
	307 LD 000	Coppia Maniglioni con placca yale, senza nicchia	AGV	•	1



			FINITURA	€	
	MANIGLIONE ALZANTE PRIAMO				
	313 MD 001	Maniglione Dritto Singolo con placca cieca e con nicchia	AGV	•	1
	313 MD 010	Maniglione Dritto Singolo con placca yale e con nicchia	AGV	•	1
	313 LD 000	Coppia Maniglioni con placca yale, senza nicchia	AGV	•	1
	313 PI 002	Nicchia per Maniglione a scatto	AGV	•	1
	ARTICOLI VARI				
	639 IN 005	Incontro per tavellino mm 5	AGV	•	50
	639 IN 010	Incontro per tavellino mm 10	AGV	•	50
	639 IN 015	Incontro per tavellino mm 15	AGV	•	50
	639 IN 020	Incontro per tavellino mm 20	AGV	•	50
	639 IN 025	Incontro per tavellino mm 25	AGV	•	50
	639 IN 030	Incontro per tavellino mm 30	AGV	•	50
	646 TV 000	Tavellino alt.00 a filo - senza incontro	AGV	•	25
	646 TV 010	Tavellino mm.10 - senza incontro	AGV	•	25
	646 TV 015	Tavellino mm.15 - senza incontro	AGV	•	25
	646 TV 018	Tavellino mm.18 - senza incontro	AGV	•	25
	646 TV 020	Tavellino mm.20 - senza incontro	AGV	•	25
	646 TV 022	Tavellino mm.22 - senza incontro	AGV	•	25
	646 TV 025	Tavellino mm.25 - senza incontro	AGV	•	25
	646 TV 030	Tavellino mm.30 - senza incontro	AGV	•	25
	646 IN	Incontro a filo per tavellino art.646	AGV	•	25
	820 AN 013	Cappuccio per cerniera anuba ø13	AGV	•	24
	820 AN 014	Cappuccio per cerniera anuba ø14	AGV	•	24
	820 AN 016	Cappuccio per cerniera anuba ø16	AGV	•	24
	821 AN 014	Cappuccio per cerniera anuba ø14	AGV	•	24
	821 AN 016	Cappuccio per cerniera anuba ø16	AGV	•	24
	828 AN 013	Cappuccio per cerniera anuba ø13	AGV	•	24
	828 AN 014	Cappuccio per cerniera anuba ø14	AGV	•	24
	828 AN 016	Cappuccio per cerniera anuba ø16	AGV	•	24
	829 AN 014	Cappuccio per cerniera anuba ø14	AGV	•	24
	829 AN 016	Cappuccio per cerniera anuba ø16	AGV	•	24
	506 CP 00A	Coppia placca incasso con nottolino alto q. 6/8	AGV	•	4
	508 CP ***	Coppia placca incasso con nottolino grande q. 6/8	AGV	•	6
	514 CP	Coppia placca incasso con nottolino pendente q. 6/8	AGV	•	4
	519 CP ***	Coppia placca incasso con nottolino ad anello q. 6/8	AGV	•	6
	503 NO 003	Nottolino libero/occupato per wc con rosetta coprivite ø45	AGV	•	6
	503 NO 006	Nottolino libero/occupato per wc con rosetta coprivite tipo lusso ø50x8	AGV	•	6
	503 NO 202	Nottolino libero/occupato per wc con rosetta ø52x9 con bordo con fori viti a vista	AGV	•	6
	520 PI 001	Placca incasso mm 152x40 con foro chiave	AGV	•	8
	520 PI 002	Placca incasso mm 152x40 cieca	AGV	•	8
	524 PI 001	Placca incasso tonda ø57 incasso ø48 con foro chiave.	AGV	•	24
	524 PI 002	Placca incasso tonda ø57 incasso ø48 cieca	AGV	•	24
	525 PI	Frontalino di trascinamento ø29 incasso ø25	AGV	•	24
	529 PI 001	Placca incasso ø48 con bordo di presa con foro chiave.	AGV	•	24
	529 PI 002	Placca incasso ø48 con bordo di presa cieca	AGV	•	24
	003 BY ***	Bocchetta coprivite ø45 foro yale	AGV	•	24
	006 BY ***	Bocchetta coprivite tipo lusso ø50 foro yale	AGV	•	24
	007 BY ***	Bocchetta ovale stretta mm 67x27 foro yale	AGV	•	24
	011 BY ***	Bocchetta coprivite tipo lusso ø53x10 foro yale	AGV	•	24
	202 BY ***	Bocchetta ø52 con bordo foro yale	AGV	•	24
	062 BY	Bocchetta coprivite mm 82 x 62 con foro yale	AGV	•	24
	062 DM	Bocchetta coprivite mm 82 x 62 con doppia mappa	AGV	•	24



		FINITURA	€	
	020 CH T00 Chiave tonda mm 85x26	AGV	•	25
	022 CH *** Chiave ovale mm 37x85	AGV	•	25
	021 CH *** Coprichiave universale con grano mm 45x30	AGV	•	30
	531 CA *** Copriavvolgibile universale	AGV	•	12
	550 CI *** Coprinterruttore "Ticino Magic" cieco o a 1 - 2 - 3 tasti	AGV	•	12
	114 MT 096 Manettoncino int. mm 96 fil. 4MA	AGV	•	12
	305 PA *** Portabito mm 120x79	AGV	•	12
	121 PN 022 Pomolino Spidy mm 22	AGV	•	24
	121 PN 028 Pomolino Spidy mm 28	AGV	•	24
	121 PN 034 Pomolino Spidy mm 34	AGV	•	24
	121 PN 040 Pomolino Spidy mm 40	AGV	•	24
	122 PN 020 Pomolino Sfera mm 20	AGV	•	24
	122 PN 025 Pomolino Sfera mm 25	AGV	•	24
	122 PN 030 Pomolino Sfera mm 30	AGV	•	24
	070 SP 007 Segretino piccolo con rosetta mm 67x27 q. 6/7/8	AGV	•	12
	639 TV Tavellino senza incontro	AGV	•	50

		BN/AGV €	CHAMP/AGV DEC.C/AGV €	DEC.H/AGV DEC.B/AGV DEC.V/AGV €	NR/AGV €	
SERIE CINZIA						
	069 MP 040 Maniglia con placca 040 mm 244x40 con molla e grano	•	•	•	•	1
	069 MR 003 Maniglia con rosetta 003 ø45x7 con molla e grano	•	•	•	•	1
	069 MR 006 Maniglia con rosetta 006 ø50x8 tipo lusso con molla e grano	•	•	•	•	1
	069 MR 202 Maniglia con rosetta 202 ø52x9 con bordo con grano	•	•	•	•	1
	069 CR 040 Cremonese con placca 040 mm 174x37 con gioco	•	•	-	•	2
	069 MA 007 Martellina con rosetta 007 mm 67x27 q.7	•	•	-	•	2
	069 MA 040 Martellina con placca 040 mm 174x37 q.7	•	•	-	•	2
	069 DK 014 Dreh Kipp con rosetta 014 mm 80x35 con movimento in metallo	•	•	•	•	3
	069 DK 015 Dreh Kipp con rosetta 015 mm 65x31 con movimento in metallo	•	•	•	•	3
POMOLO						
	053 CR 040 Cremonese con placca 040 mm 174x37 con gioco	•	•	-	-	2
	053 MA 040 Martellina con placca 040 mm 174x37 q.7	•	•	-	-	2
	053 TK 015 Dreh Kipp con rosetta 015 mm 65x31 con impugnatura martellina a "T"	•	•	-	-	3
	053 PR 003 Coppia Pomolo con rosetta 003 ø45x7 con grano	•	•	-	-	2
	053 PR 006 Coppia Pomolo con rosetta 006 ø50x8 tipo lusso con grano	•	•	-	-	2
	053 PR 202 Coppia Pomolo con rosetta 202 ø52x9 con bordo con grano	•	•	-	-	2
	053 PR R40 Coppia Pomolo con rosetta R40 ø45x7 con fori viti con grano	•	•	-	-	2



Il trattamento speciale subito dal prodotto può causare piccole variazioni di tonalità nella finitura, non imputabili a difetto, bensì alla ricerca dell'ottenimento del migliore effetto di invecchiamento.

The special treatment of these products can lead to a small color variations on finish, that enhances its Vintage features.

ottone RUGGINE
OXIDE BRASS

COLLECTION





40 CR 040
40 MA 040



40 MP 040

40 DK 015



REGUCCI®



40 MR 416



40 MR 006



40 MR 202



189 MP 040



189 DK 015



189 MR 416



OTTONE RUGGINE
oxide brass



189 MR 006



189 MR 202





69 MP 040 DEC.C/RX



69 DK 015 DEC.C/RX



69 MR 416 DEC.C/RX

REGUETTI[®]



69 MR 006 DEC.C/RX



69 MR 202 DEC.C/RX



69 MP 040 DEC.H/RX



69 DK 015 DEC.H/RX



69 MR 416 DEC.H/RX



OTTONE RUGGINE
oxide brass



69 MR 006 DEC.H/RX



69 MR 202 DEC.H/RX





800 MR 006



800 MR 006



828 AN



829 AN



646 TV

646 IN

REGUETTI®



49 MR 406



49 MR 007

destra/right



49 DK 015



93 MR 207



H56 PF 73R
H56 PO 73R



40 MD 202



OTTONE RUGGINE
oxide brass

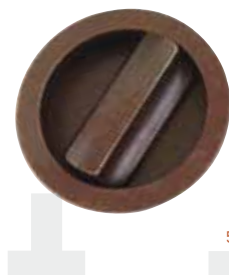

508 CP



525 PI



524 PI 001



524 PI 002





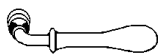

			FINITURA	€	
	SERIE GINEVRA				
	040 MP 040	Maniglia con placca 040 mm 244x40 con molla e grano	RX	39,41	1
	040 MP 026	Maniglia con placca 026 mm 225x26 stretta con grano	RX	37,33	1
	040 MR 004	Maniglia con rosetta 004 ø45x9 con molla e grano	RX	38,07	2
	040 MR 006	Maniglia con rosetta 006 ø50x8 tipo lusso con molla e grano	RX	49,93	1
	040 MR 007	Maniglia con rosetta 007 mm 67x27 ovale stretta con grano	RX	38,07	2
	040 MR 009	Maniglia con rosetta 009 mm 62x32 ovale con molla e grano	RX	40,35	1
	040 MR 202	Maniglia con rosetta 202 ø52x9 con bordo con grano	RX	35,99	2
	040 MR 416	Maniglia con rosetta 416 ø45x9 con molla e grano	RX	38,07	2
	040 CR 040	Cremonese con placca 040 mm 174x37 con gioco	RX	22,24	2
	040 CR 063	Cremonese con placca 063 mm 143x37 con gioco M.P. per aste esterne	RX	22,24	2
	040 MA 007	Martellina con rosetta 007 mm 67x27 q.7	RX	19,16	2
	040 MA 040	Martellina con placca 040 mm 174x37 q.7	RX	20,97	2
	040 DK 015	Dreh Kipp con rosetta 015 mm 65x31 con movimento in metallo	RX	23,65	3
	SERIE TOSCA				
	049 MP 040	Maniglia con placca 040 mm 244x40 con grano	RX	40,41	1
	049 MP 026	Maniglia con placca 026 mm 225x26 stretta con grano	RX	38,33	1
	049 MR 006	Maniglia con rosetta 006 ø50x8 tipo lusso con grano	RX	50,93	2
	049 MR 007	Maniglia con rosetta 007 mm 67x27 ovale stretta con grano	RX	39,07	2
	049 MR 202	Maniglia con rosetta 202 ø52x9 con bordo con grano	RX	36,99	2
	049 MR 406	Maniglia con rosetta 406 mm Ø45x9 con grano	RX	36,99	1
	049 CR 040	Cremonese con placca 040 mm 174x37 con gioco	RX	19,40	2
	049 MA 040	Martellina con placca 040 mm 174x37 q.7	RX	18,12	2
	049 MA 007	Martellina con rosetta 007 mm 67x27 q.7	RX	16,32	2
	049 DK 015	Dreh Kipp con rosetta 015 mm 65x31 con movimento in metallo	RX	24,12	3
	SERIE BALTIC				
	073 MR 382	Maniglia con rosetta 382 ø50x8 profilo a campana con molla e grano	RX	73,37	1
	SERIE NORDICA				
	093 MR 207	Maniglia con rosetta 207mm ø56 con grano	RX	51,52	1
	SERIE PRAGA				
	166 MP 040	Maniglia con placca 040 mm 244x40 con molla e grano	RX	43,83	1
	166 MP 026	Maniglia con placca 026 mm 225x26 stretta con grano	RX	41,75	1
	166 MR 004	Maniglia con rosetta 004 ø45x9 con molla e grano	RX	42,49	2
	166 MR 006	Maniglia con rosetta 006 ø50x8 tipo lusso con molla e grano	RX	54,35	2
	166 MR 007	Maniglia con rosetta 007 mm 67x27 ovale stretta con grano	RX	42,49	2
	166 MR 009	Maniglia con rosetta 009 mm 62x32 ovale con molla e grano	RX	44,77	1
	166 MR 202	Maniglia con rosetta 202 ø52x9 con bordo con grano	RX	40,41	2
	166 MR 416	Maniglia con rosetta 416 ø45x9 con molla e grano	RX	42,49	1
	166 CR 040	Cremonese con placca 040 mm 174x37 con gioco	RX	28,48	2
	166 MA 040	Martellina con placca 040 mm 174x37 q.7	RX	27,20	2
	166 MA 007	Martellina con rosetta 007 mm 67x27 q.7	RX	25,39	4
	166 DK 015	Dreh Kipp con rosetta 015 mm 65x31 con movimento in metallo	RX	25,86	3
	SERIE VIENNA				
	167 MP 039	Maniglia con placca 039 mm 255x50 con molla e grano	RX	60,29	1
	167 MP 040	Maniglia con placca 040 mm 244x40 con molla e grano	RX	51,87	1
	167 MP 026	Maniglia con placca 026 mm 225x26 stretta con grano	RX	49,79	1
	167 MR 004	Maniglia con rosetta 004 ø45x9 con molla e grano	RX	50,53	2
	167 MR 006	Maniglia con rosetta 006 ø50x8 tipo lusso con molla e grano	RX	62,39	2
	167 MR 007	Maniglia con rosetta 007 mm 67x27 ovale stretta con grano	RX	50,53	2
	167 MR 009	Maniglia con rosetta 009 mm 62x32 ovale con molla e grano	RX	52,81	1
	167 MR 202	Maniglia con rosetta 202 ø52x9 con bordo con grano	RX	48,45	2
	167 MR 416	Maniglia con rosetta 416 ø45x9 con molla e grano	RX	50,53	2
	167 CR 040	Cremonese con placca 040 mm 174x37 con gioco	RX	28,48	2
	167 MA 040	Martellina con placca 040 mm 174x37 q.7	RX	27,20	2
	167 MA 007	Martellina con rosetta 007 mm 67x27 q.7	RX	25,39	2
	167 DK 015	Dreh Kipp con rosetta 015 mm 65x31 con movimento in metallo	RX	29,88	3



SERIE ROMA

			FINITURA	€	
	189 MP 040	Maniglia con placca 040 mm 244x40 con molla e grano	RX	47,58	1
	189 MP 026	Maniglia con placca 026 mm 225x26 stretta con grano	RX	45,51	1
	189 MR 004	Maniglia con rosetta 004 ø45x9 con molla e grano	RX	46,24	2
	189 MR 006	Maniglia con rosetta 006 ø50x8 tipo lusso con molla e grano	RX	58,10	2
	189 MR 007	Maniglia con rosetta 007 mm 67x27 ovale stretta con grano	RX	46,24	2
	189 MR 009	Maniglia con rosetta 009 mm 62x32 ovale con molla e grano	RX	48,52	1
	189 MR 202	Maniglia con rosetta 202 ø52x9 con bordo con grano	RX	44,17	2
	189 MR 416	Maniglia con rosetta 416 ø45x9 con molla e grano	RX	46,24	1
	189 CR 040	Cremonese con placca 040 mm 174x37 con gioco	RX	26,33	2
	189 MA 040	Martellina con placca 040 mm 174x37 q.7	RX	25,06	2
	189 MA 007	Martellina con rosetta 007 mm 67x27 q.7	RX	23,25	4
	189 DK 015	Dreh Kipp con rosetta 015 mm 65x31 con movimento in metallo	RX	27,74	3

SERIE OVALINO

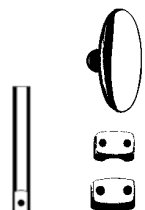

	190 MA 040	Martellina con placca 040 mm 174x37 q.7	RX	21,04	2
	190 MA 007	Martellina con rosetta 007 mm 67x27 q.7	RX	19,23	4
	190 TK 015	Dreh Kipp con rosetta 015 mm 65x31 con impugnatura martellina a "T"	RX	23,72	2
	190 CR 040	Cremonese con placca 040 mm 174x37 con gioco	RX	22,31	2
	190 CR 063	Cremonese con placca 063 mm 143x37 con gioco M.P. per aste esterne	RX	22,31	2
	410 AT 150	Asta mm 7x16 lunghezza cm.150	RX	49,58	12
	411 NL ***	Solo finale mm 35x22	RX	3,62	50
	411 NT ***	Solo passante mm 35x22	RX	3,62	50



SERIE OVALINO



	191 MP 040	Maniglia con placca 040 mm 244x40 con molla e grano	RX	47,24	1
	191 MR 416	Maniglia con rosetta 416 ø45x9 con molla e grano	RX	45,90	1
	191 MR 006	Maniglia con rosetta 006 ø50x8 tipo lusso con molla e grano	RX	57,75	2
	191 MR 007	Maniglia con rosetta 007 mm 67x27 ovale stretta con grano	RX	43,82	2
	191 MR 009	Maniglia con rosetta 009 mm 62x32 ovale con molla e grano	RX	48,17	1
	191 MR 202	Maniglia con rosetta 202 ø52x9 con bordo con grano	RX	43,82	2
	191 DK 015	Dreh Kipp con rosetta 015 mm 65x31 con movimento in metallo	RX	23,32	3



SERIE EPOCA









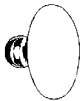

	800 MP 039	Maniglia con placca 039 mm 255x50 con molla e grano	RX	59,98	1
	800 MP 040	Maniglia con placca 040 mm 244x40 con molla e grano	RX	51,56	1
	800 MP 026	Maniglia con placca 026 mm 225x26 stretta con grano	RX	49,48	1
	800 MR 004	Maniglia con rosetta 004 ø45x9 con molla e grano	RX	50,22	1
	800 MR 006	Maniglia con rosetta 006 ø50x8 tipo lusso con molla e grano	RX	62,08	1
	800 MR 202	Maniglia con rosetta 202 ø52x9 con bordo con grano	RX	48,14	1
	800 MR 416	Maniglia con rosetta 416 ø45x9 con molla e grano	RX	50,22	1
	800 MR 916	Maniglia con rosetta 916 mm 62x32 ovale c/molla ambidestra e grano	RX	52,50	1
	800 SG 040	Cremonese con placca 040 mm 174x37 con gioco	RX	28,28	2
	800 SE 040	Martellina con placca 040 mm 174x37 q.7	RX	27,01	2
	800 DK 015	Dreh Kipp con rosetta 015 mm 65x31 con movimento in metallo	RX	29,69	3
	800 DK C67	Dreh Kipp c/rosetta C67 mm 69x33 c/chave e cilindro e mov. in metallo	RX	77,59	2

SERIE CHARME



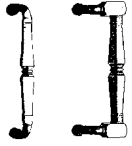

















	900 MP 039	Maniglia con placca 039 mm 255x50 con molla e grano	RX	59,98	1
	900 MP 040	Maniglia con placca 040 mm 244x40 con molla e grano	RX	51,56	1
	900 MP 026	Maniglia con placca 026 mm 225x26 stretta con grano	RX	49,48	1
	900 MR 004	Maniglia con rosetta 004 ø45x9 con molla e grano	RX	50,22	1
	900 MR 006	Maniglia con rosetta 006 ø50x8 tipo lusso con molla e grano	RX	62,08	1
	900 MR 202	Maniglia con rosetta 202 ø52x9 con bordo con grano	RX	48,14	1
	900 MR 416	Maniglia con rosetta 416 ø45x9 con molla e grano	RX	50,22	1
	900 MR 916	Maniglia con rosetta 916 mm 62x32 ovale c/molla ambidestra e grano	RX	52,50	1
	900 SG 040	Cremonese con placca 040 mm 174x37 con gioco	RX	28,28	2
	900 SE 040	Martellina con placca 040 mm 174x37 q.7	RX	27,01	2
	900 DK 015	Dreh Kipp con rosetta 015 mm 65x31 con movimento in metallo	RX	29,69	3
	900 DK C67	Dreh Kipp c/rosetta C67 mm 69x33 c/chave e cilindro e mov. in metallo	RX	77,59	2



		FINITURA	€	
POMOLO SERIE OVUM				
	048 PF 002	Pomolo Fisso con rosetta 002 ø45x10 con piastrina	RX	• 4
	048 PF 006	Pomolo Fisso con rosetta 006 ø50x8 con piastrina	RX	• 4
	048 PF 009	Pomolo Fisso con rosetta 009 mm 62x32 ovale con piastrina	RX	• 4
	048 PR 406	Coppia Pomolo ø60 con rosetta 406 ø45x9 con grano	RX	• 2
	048 PR 006	Coppia Pomolo con rosetta 006 ø50x8 tipo lusso con grano	RX	• 2
	048 PR 009	Coppia Pomolo con rosetta 009 mm 62x32 ovale con grano	RX	• 2
POMOLO SERIE APOLLO				
	055 PR 416	Coppia Pomolo con rosetta 416 ø45x9 con molla e grano	RX	• 1
	055 PR 006	Coppia Pomolo con rosetta 006 ø50x8 tipo lusso con molla e grano	RX	• 1
	055 PR 009	Coppia Pomolo con rosetta 009 mm 62x32 ovale con molla e grano	RX	• 1
POMOLO SERIE COSMO				
	E56 PR 406	Coppia Pomolo ø60 con rosetta 406 ø45x9 con grano	RX	• 2
	E56 PR 006	Coppia Pomolo ø60 con rosetta 006 ø50x8 tipo lusso con grano	RX	• 2
	E56 PR 202	Coppia Pomolo ø60 con rosetta 202 ø52x9 con bordo con grano	RX	• 2
	E56 PO 73R	Pomolo Fisso ø60 con rosetta 73R ø72x9 con troncone filettato	RX	• 4
	H56 PO 73R	Pomolo Fisso ø75 con rosetta 73R ø72x9 con troncone filettato	RX	• 2
	E56 PF 002	Pomolo Fisso ø60 con rosetta 002 ø45x10 con piastrina	RX	• 4
	E56 PF 73R	Pomolo Fisso ø60 con rosetta 73R ø72x9 con piastrina	RX	• 4
	H56 PF 002	Pomolo Fisso ø75 con rosetta 002 ø45x10 con piastrina	RX	• 2
H56 PF 73R	Pomolo Fisso ø75 con rosetta 73R ø72x9 con piastrina	RX	• 2	
POMOLO SERIE MARGHERITA				
	E57 PR 406	Coppia Pomolo ø60 con rosetta 406 ø45x9 con grano	RX	• 2
	E57 PR 006	Coppia Pomolo ø60 con rosetta 006 ø50x8 tipo lusso con grano	RX	• 2
	E57 PR 202	Coppia Pomolo ø60 con rosetta 202 ø52x9 con bordo con grano	RX	• 2
	E57 PF 73R	Pomolo Fisso ø60 con rosetta 73R ø72x9 con piastrina	RX	• 4
	H57 PF 73R	Pomolo Fisso ø75 con rosetta 73R ø72x9 con piastrina	RX	• 2
	E57 PO 73R	Pomolo Fisso ø60 con rosetta 73R ø72x9 con troncone filettato	RX	• 4
H57 PO 73R	Pomolo Fisso ø75 con rosetta 73R ø72x9 con troncone filettato	RX	• 2	
SET BOCCHETTE DI SICUREZZA				
	CD 002	"Set bocchette di sicurezza ø52 con protezione cilindro regolabile e 2 viti passanti M5-interasse mm.38 - completo di sottobocchetta in acciaio speciale temprato antitrapano"	RX	• 1
	CD 006	"Set bocchette di sicurezza ovali mm 92x35 con protezione cilindro regolabile e 2 viti passanti M6 - completo di sottobocchetta in acciaio speciale temprato antitrapano"	RX	• 1
MANIGLIONE SERIE GINEVRA				
	040MD004	Maniglione Diritto Singolo con rosetta 004 ø45x9	RX	• 2
	040MD006	Maniglione Diritto Singolo con rosetta 006 ø50x8 tipo lusso	RX	• 2
	040MD202	Maniglione Diritto Singolo con rosetta 202 ø52x9 con bordo	RX	• 2
	040MS004	Maniglione Spostato Singolo con rosetta 004 ø45x9	RX	• 2
	040MS006	Maniglione Spostato Singolo con rosetta 006 ø50x8 tipo lusso	RX	• 2
	040MS202	Maniglione Spostato Singolo con rosetta 202 ø52x9 con bordo	RX	• 2
BATTENTI				
	006BA73R	Battente "Giove" con rosetta 73R ø72x9	RX	• 1
	013BA73R	Battente "Helios" con rosetta 73R ø72x9	RX	• 1
ARTICOLI VARI				
	003BY***	Bocchetta coprivate ø45 foro yale	RX	• 24
	006BY***	Bocchetta coprivate tipo lusso ø50 foro yale	RX	• 24
	007BY***	Bocchetta ovale stretta mm 67x27 foro yale	RX	• 24
	009BY***	Bocchetta coprivate ovale mm 62x32 foro yale	RX	• 24
	202BY***	Bocchetta ø52 con bordo foro yale	RX	• 24
062BY	Bocchetta coprivate mm 82 x 62 con foro yale	RX	• 12	
	062DM	Bocchetta coprivate mm 82 x 62 con doppia mappa	RX	• 12



			FINITURA	€	
	022CH***	Chiave ovale mm 37x85	RX	•	25
	531CA***	Copriavvolgibile universale	RX	•	12
	550CJ***	Coprinteruttore "Ticino Magic" cieco o a 1 - 2 - 3 tasti	RX	•	12
	114MT096	Manettoncino int. mm. 96 fil. 4MA	RX	•	12
	305PA***	Portabito mm.120x79	RX	•	12
	121PN022	Pomolino Spidy mm. 22	RX	•	24
	121PN028	Pomolino Spidy mm. 28	RX	•	24
	121PN034	Pomolino Spidy mm. 34	RX	•	24
	121PN040	Pomolino Spidy mm. 40	RX	•	24
	063SP007	Segretino piccolo con rosetta mm 67x27 q. 6/7/8	RX	•	12
	070SP007	Segretino piccolo con rosetta mm 67x27 q. 6/7/8	RX	•	12
	639 TV	Incontro a filo per tavellino art. 639	RX	•	50
	639 IN 005	Tavellino mm 5 - senza incontro	RX	•	50
	639 IN 010	Tavellino mm 10 - senza incontro	RX	•	50
	639 IN 015	Tavellino mm 15 - senza incontro	RX	•	50
	639 IN 020	Tavellino mm 20 - senza incontro	RX	•	50
	639 IN 025	Tavellino mm 25 - senza incontro	RX	•	50
	639 IN 030	Tavellino mm 30 - senza incontro	RX	•	50
	646TV000	Tavellino alt.00 a filo - senza incontro	RX	•	25
	646TV010	Tavellino mm.10 - senza incontro	RX	•	25
	646TV015	Tavellino mm.15 - senza incontro	RX	•	25
	646TV018	Tavellino mm.18 - senza incontro	RX	•	25
	646TV020	Tavellino mm.20 - senza incontro	RX	•	25
	646TV022	Tavellino mm.22 - senza incontro	RX	•	25
	646TV025	Tavellino mm.25 - senza incontro	RX	•	25
	646TV030	Tavellino mm.30 - senza incontro	RX	•	25
	646IN	Incontro a filo per tavellino art.646	RX	•	25
	CAPPUCCI PER CERNIERE				
	828AN013	Cappuccio per cerniera anuba ø13	RX	•	24
	828AN014	Cappuccio per cerniera anuba ø14	RX	•	24
	828AN016	Cappuccio per cerniera anuba ø16	RX	•	24
	829AN014	Cappuccio per cerniera anuba ø14	RX	•	24
	829AN016	Cappuccio per cerniera anuba ø16	RX	•	24
	COPPIE PLACCHE INCASSO				
	506CP00A	Coppia placca incasso con nottolino alto q. 6/8	RX	•	4
	508CP***	Coppia placca incasso con nottolino grande q. 6/8	RX	•	6
	514CP	Coppia placca incasso con nottolino pendente q. 6/8	RX	•	4
	519CP***	Coppia placca incasso con nottolino ad anello q. 6/8	RX	•	6
	NOTTOLINO				
	503NO406	Nottolino libero/occupato per wc con rosetta coprivite 406 ø45x9	RX	•	6
	503NO006	Nottolino libero/occupato per wc con rosetta coprivite tipo lusso ø50x8	RX	•	6
	503NO202	Nottolino libero/occupato per wc con rosetta ø52x9 con bordo con fori viti a vista	RX	•	6
	MANIGLIONE SERIE ENEA				
	030MD001	Maniglione Diritto Singolo con placca cieca e con nicchia	RX	•	1
	030MD010	Maniglione Diritto Singolo con placca yale e con nicchia	RX	•	1
	030LD000	Coppia Maniglion con placca yale, senza nicchia	RX	•	1
	MANIGLIONE SERIE BERNINI				
	307MD001	Maniglione Diritto Singolo con placca cieca e con nicchia	RX	•	1
	307MD010	Maniglione Diritto Singolo con placca yale e con nicchia	RX	•	1
	307LD000	Coppia Maniglion con placca yale, senza nicchia	RX	•	1



MANIGLIONE SERIE PRIAMO

		FINITURA	€	
313MD001	Maniglione Diritto Singolo con placca cieca e con nicchia	RX	•	1
313MD010	Maniglione Diritto Singolo con placca yale e con nicchia	RX	•	1
313LD000	Coppia Maniglioni con placca yale, senza nicchia	RX	•	1
313PI002	Nicchia per Maniglione a scatto	RX	•	1



PLACCHE INCASSO

520PI001	Placca incasso mm 152x40 con foro chiave	RX	•	16
520PI002	Placca incasso mm 152x40 cieca	RX	•	16
524PI001	Placca incasso tonda ø57 incasso ø48 con foro chiave.	RX	•	24
524PI002	Placca incasso tonda ø57 incasso ø48 cieca	RX	•	24
525PI	Frontalino di trascinalimento ø29 incasso ø25	RX	•	24
529PI001	Placca incasso ø48 con bordo di presa con foro chiave.	RX	•	24
529PI002	Placca incasso ø48 cieca con bordo di presa	RX	•	24



SERIE CINZIA

		BN/RX €	CHAMP/ RXDEC.C/RX €	DEC.H/RX DEC.B/RX DEC.V/RX €	
069MP040	Maniglia con placca 040 mm 244x40 con molla e grano	•	•	•	1
069MR004	Maniglia con rosetta 004 ø45x9 con molla e grano	•	•	•	1
069MR006	Maniglia con rosetta 006 ø50x8 tipo lusso con molla e grano	•	•	•	1
069MR202	Maniglia con rosetta 202 ø52x9 con bordo con grano	•	•	•	1
069MR416	Maniglia con rosetta 416 ø45x9 con molla e grano	•	•	•	1
069CR040	Cremonese con placca 040 mm 174x37 con gioco	•	•	-	2
069MA040	Martellina con placca 040 mm 174x37 q.7	•	•	-	2
069DK015	Dreh Kipp con rosetta 015 mm 65x31 con movimento in metallo	•	•	•	3

POMOLO



053PR406	Coppia Pomolo con rosetta ø45x9 con grano	•	•	-	2
053PR006	Coppia Pomolo con rosetta 006 ø50x8 tipo lusso con grano	•	•	-	2
053PR202	Coppia Pomolo con rosetta 202 ø52x9 con bordo con grano	•	•	-	2
053TK015	Dreh Kipp con rosetta 015 mm 65x31 con impugnatura martellina a "T"	•	•	-	3
053CR040	Cremonese con placca 040 mm 174x37 con gioco	•	•	-	2
053MA040	Martellina con placca 040 mm 174x37 q.7	•	•	-	2
053PP040	Coppia Pomolo con placca 040 mm 244x40 con grano	•	•	-	1



Per ottenere questo effetto sono state utilizzate speciali tecniche di lavorazione, eseguite solo manualmente. Per questo motivo non è possibile garantire una omogeneità su tutti i prodotti, i quali possono presentare variazioni di aspetto che sono assolutamente normali e non vanno considerate come imperfezioni.

The special treatment of these products can lead to a small color variations on finish, that enhances its Vintage features.

ottone RUSTICO
RUSTIK BRASS

COLLECTION



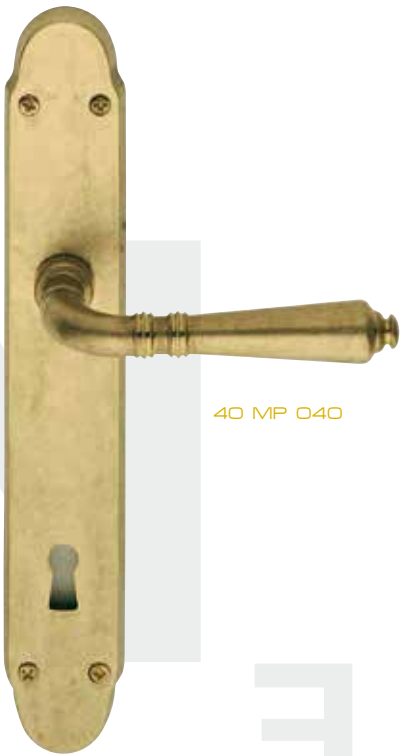

40 MP 040



40 CR 040
40 MA 040



40 DK 015
40 DK 024

REGUCCI®



40 MR 202



T36 MR 416



40 MR 006



800 MR 006



900 MR 006



800 DK 015



900 DK C67



T88 MR 202



OTTONE **RUSTICO**
rustikbrass



137 MR 007

destra/right



49 DK 015



49 MR 007



49 MR R40





69 MP 040 CHAMP/VBN



69 CR 040 CHAMP/VBN
69 MA 040 CHAMP/VBN



69 DK 015 CHAMP/VBN



69 MR 004 CHAMP/VBN

REGUCCI®



40 MD 202



40 MS 006



829 AN



828 AN

REGUCCI®
Maniglie & Accessori



411 NL



411 NT



411 NT



410 AT



190 CR 063



411 NT



411 NL



189 CR 040
189 MA 040



189 DK 015



189 MR 004



93 MR 207



189 MR 006

OTTONE **RUSTICO**
rustikbrass





H56 PF 73R
H56 PO 73R



E56 PR 003



E57 PR 202



H57 PF 73R
H57 PO 73R



REGUETTI®

13 BA 73R



6 BA 73R



506 CP

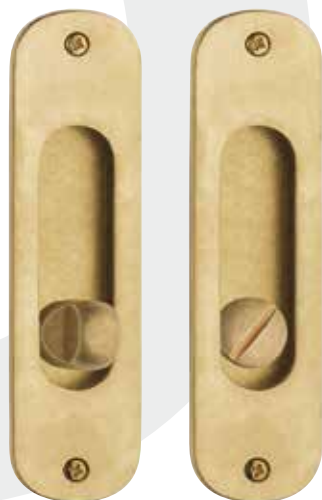

520 PI 001



508 CP



519 CP



525 PI

CD 002



OTTONE **RUSTICO**
rustikbrass



006 BY



003 BY



524 PI 001



529 PI 001



202 BY



007BY



503 NO 003





SERIE GINEVRA

			FINITURA	€	
040 MP 040	Maniglia con placca 040 mm 244x40 con molla e grano		VBN	•	1
040 MP 026	Maniglia con placca 026 mm 225x26 stretta con grano		VBN	•	1
040 MR 004	Maniglia con rosetta 004 Ø45x9 con molla e grano		VBN	•	2
040 MR 006	Maniglia con rosetta 006 Ø50x8 tipo lusso con molla e grano		VBN	•	2
040 MR 007	Maniglia con rosetta 007 mm 67x27 ovale stretta con grano		VBN	•	2
040 MR 009	Maniglia con rosetta 009 mm 62x32 ovale con molla e grano		VBN	•	1
040 MR 202	Maniglia con rosetta 202 Ø52x9 con bordo con grano		VBN	•	2
 040 MR 416	Maniglia con rosetta 416 Ø45x9 con molla e grano		VBN	•	1
040 CR 040	Cremonese con placca 040 mm 174x37 con gioco		VBN	•	2
040 MA 007	Martellina con rosetta 007 mm 67x27 ovale stretta q.7		VBN	•	2
040 MA 040	Martellina con placca 040 mm 174x37 q. 7		VBN	•	2
040 CR 063	Cremonese con placca 063 mm 143x37 con gioco MP per aste esterne		VBN	•	2
040 DK 014	Dreh Kipp con rosetta 014 mm 80x35 con movimento in metallo		VBN	•	3
040 DK 015	Dreh Kipp con rosetta 015 mm 65x31 con movimento in metallo		VBN	•	3
040 DK 024	Dreh Kipp c/rosetta 024 mm 65x31 c/mov. in metallo e quadro autoregolante		VBN	•	3
040 DK 075	Dreh Kipp c/rosetta 075 mm 64x30 con mov. securblock e puls. di sicurezza		VBN	•	2
040 DK C67	Dreh Kipp c/rosetta C67 mm 69x33 c/chiave e cilindro e mov. in metallo		VBN	•	1

SERIE TOSCA



049 MP 166	Maniglia con placca 166 mm 242x33 con grano		VBN	•	1
049 MP 040	Maniglia con placca 040 mm 244x40		VBN	•	1
049 MP 026	Maniglia con placca 026 mm 225x26 stretta con grano		VBN	•	1
049 MR 006	Maniglia con rosetta 006 ø50x8 tipo lusso con grano		VBN	•	2
049 MR 007	Maniglia con rosetta 007 mm 67x27 ovale stretta con grano		VBN	•	2
049 MR 202	Maniglia con rosetta 202 ø52x9 con bordo con grano		VBN	•	2
049 MR R40	Maniglia con rosetta R40 ø45x7 con fori viti a vista con grano		VBN	•	2
049 CR 040	Cremonese con placca 040 mm 174x37 con gioco		VBN	•	2
049 MA 040	Martellina con placca 040 mm 174x37 q.7		VBN	•	2
049 MA 007	Martellina con rosetta 007 mm 67x27 q.7		VBN	•	2
049 DK 015	Dreh Kipp con rosetta 015 mm 65x31 con movimento in metallo		VBN	•	3

SERIE DESY



137 MP 040	Maniglia con placca 040 mm 244x40		VBN	•	1
137 MR 006	Maniglia con rosetta 006 ø50x8 tipo lusso con grano		VBN	•	2
137 MR 007	Maniglia con rosetta 007 mm 67x27 ovale stretta con grano		VBN	•	2
137 DK 015	Dreh Kipp con rosetta 015 mm 65x31 con movimento in metallo		VBN	•	3

SERIE ROMEA

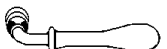

189 MP 040	Maniglia con placca 040 mm 244x40 con molla e grano		VBN	•	1
189 MR 004	Maniglia con rosetta 004 Ø45x9 con molla e grano		VBN	•	2
189 MR 006	Maniglia con rosetta 006 Ø50x8 tipo lusso con molla e grano		VBN	•	2
189 MR 416	Maniglia con rosetta 416 Ø45x9 con molla e grano		VBN	•	1
189 MR 202	Maniglia con rosetta 202 Ø52x9 con bordo con grano		VBN	•	2
189 CR 040	Cremonese con placca 040 mm 174x37 con gioco		VBN	•	2
189 MA 040	Martellina con placca 040 mm 174x37 q. 7		VBN	•	2
189 MA 007	Martellina con rosetta 007 mm 67x27 ovale stretta q.7		VBN	•	2
189 DK 015	Dreh Kipp con rosetta 015 mm 65x31 con movimento in metallo		VBN	•	3
189 DK C67	Dreh Kipp c/rosetta C67 mm 69x33 c/chiave e cilindro e mov. in metallo		VBN	•	1

SERIE NORDICA



093 MR 207	Maniglia con rosetta 207 Ø56 con grano		VBN	•	1
------------	--	--	-----	---	---

SERIE OVALINO

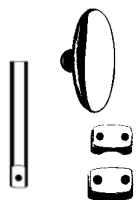

190 MA 040	Martellina con placca 040 mm 174x37 q. 7		VBN	•	2
190 CR 040	Cremonese con placca 040 mm 174x37 con gioco		VBN	•	2
190 CR 063	Cremonese con placca 063 mm 143x37 con gioco M.P. per aste esterne		VBN	•	2
410 AT 150	Asta mm 7x16 lunghezza cm 150		VBN	•	12
410 AT 180	Asta mm 7x16 lunghezza cm 180		VBN	•	12
410 AT 200	Asta mm 7x16 lunghezza cm 200		VBN	•	12
411 NL ***	Solo finale mm 35x22		VBN	•	50
411 NT ***	Solo passante mm 35x22		VBN	•	50



SERIE EPOCA

800 MP 039	Maniglia con placca 039 mm 255x50 con molla e grano	VBN	•	1
800 MP 040	Maniglia con placca 040 mm 244x40 con molla e grano	VBN	•	1
800 MP 026	Maniglia con placca 026 mm 225x26 stretta con grano	VBN	•	1
800 MR 004	Maniglia con rosetta 004 ø45x9 con molla e grano	VBN	•	1
800 MR 006	Maniglia con rosetta 006 ø50x8 tipo lusso con molla e grano	VBN	•	1
800 MR 011	Maniglia con rosetta 011 ø53x10 tipo lusso con molla e grano	VBN	•	1
800 MR 202	Maniglia con rosetta 202 ø52x9 con bordo con grano	VBN	•	1
800 MR 916	Maniglia con rosetta 916 mm 62x32 ovale c/molla ambidestra e grano	VBN	•	1
800 SG 040	Cremonese con placca 040 mm 174x37 con gioco	VBN	•	2
800 SE 040	Martellina con placca 040 mm 174x37 q.7	VBN	•	2
800 DK 015	Dreh Kipp con rosetta 015 mm 65x31 con movimento in metallo	VBN	•	3
800 DK C67	Dreh Kipp c/rosetta C67 mm 69x33 c/chave e cilindro e mov. in metallo	VBN	•	1



SERIE CHARME

900 MP 039	Maniglia con placca 039 mm 255x50 con molla e grano	VBN	•	1
900 MP 040	Maniglia con placca 040 mm 244x40 con molla e grano	VBN	•	1
900 MP 026	Maniglia con placca 026 mm 225x26 stretta con grano	VBN	•	1
900 MR 004	Maniglia con rosetta 004 ø45x9 con molla e grano	VBN	•	1
900 MR 006	Maniglia con rosetta 006 ø50x8 tipo lusso con molla e grano	VBN	•	1
900 MR 011	Maniglia con rosetta 011 ø53x10 tipo lusso con molla e grano	VBN	•	1
900 MR 202	Maniglia con rosetta 202 ø52x9 con bordo con grano	VBN	•	1
900 MR 916	Maniglia con rosetta 916 mm 62x32 ovale c/molla ambidestra e grano	VBN	•	1
900 SG 040	Cremonese con placca 040 mm 174x37 con gioco	VBN	•	2
900 SE 040	Martellina con placca 040 mm 174x37 q.7	VBN	•	2
900 DK 015	Dreh Kipp con rosetta 015 mm 65x31 con movimento in metallo	VBN	•	3
900 DK C67	Dreh Kipp c/rosetta C67 mm 69x33 c/chave e cilindro e mov. in metallo	VBN	•	2



SERIE TUSCANIA

T36 MR 006	Maniglia con rosetta 006 ø50x8 tipo lusso con molla e grano	VBN	•	1
T36 MR 007	Maniglia con rosetta 007 mm 67x27 ovale stretta con grano	VBN	•	2
T36 MR 416	Maniglia con rosetta 416 ø45x9 con molla e grano	VBN	•	1
T36 MR T36	Maniglia con rosetta T36 mm ø45x9 con bordo	VBN	•	2



SERIE ELBA

T88 MR 007	Maniglia con rosetta 007 mm 67x27 ovale stretta con grano	VBN	•	2
T88 MR 009	Maniglia con rosetta 009 mm 62x32 ovale con molla e grano	VBN	•	1
T88 MR 202	Maniglia con rosetta 202 ø52x9 con bordo con grano	VBN	•	2
T88 MR T36	Maniglia con rosetta T36 mm ø45x9 con bordo	VBN	•	2

POMOLO SERIE COSMO



E56 PR 003	Coppia Pomolo Ø60 con rosetta 003 Ø45x7 con grano	VBN	•	2
E56 PR 006	Coppia Pomolo Ø60 con rosetta 006 Ø50x8 tipo lusso con grano	VBN	•	2
E56 PR 202	Coppia Pomolo Ø60 con rosetta 202 Ø52x9 con bordo con grano	VBN	•	2
E56 PO 73R	Pomolo Fisso Ø60 con rosetta 73R Ø72x9 con troncone filettato	VBN	•	4
H56 PO 73R	Pomolo Fisso Ø75 con rosetta 73R Ø72x9 con troncone filettato	VBN	•	2
E56 PF 73R	Pomolo Fisso Ø60 con rosetta 73R Ø72x9 con piastrina	VBN	•	4
H56 PF 73R	Pomolo Fisso Ø75 con rosetta 73R Ø72x9 con piastrina	VBN	•	2

POMOLO SERIE MARGHERITA



E57 PR 003	Coppia Pomolo Ø60 con rosetta 003 Ø45x7 con grano	VBN	•	2
E57 PR 006	Coppia Pomolo Ø60 con rosetta 006 Ø50x8 tipo lusso con grano	VBN	•	2
E57 PR 202	Coppia Pomolo Ø60 con rosetta 202 Ø52x9 con bordo con grano	VBN	•	2
E57 PO 73R	Pomolo Fisso Ø60 con rosetta 73R Ø72x9 con troncone filettato	VBN	•	4
H57 PO 73R	Pomolo Fisso Ø75 con rosetta 73R Ø72x9 con troncone filettato	VBN	•	2
E57 PF 73R	Pomolo Fisso Ø60 con rosetta 73R Ø72x9 con piastrina	VBN	•	4
H57 PF 73R	Pomolo Fisso Ø75 con rosetta 73R Ø72x9 con piastrina	VBN	•	2

SET BOCCHETTE DI SICUREZZA



CD 002	"Set bocchette di sicurezza ø52 con protezione cilindro regolabile e 2 viti passanti M5-interasse mm.38 - completo di sottobocchetta in acciaio speciale temprato antitrapano"	VBN	•	1
CD 006	"Set bocchette di sicurezza ovali mm 92x35 con protezione cilindro regolabile e 2 viti passanti M6 - completo di sottobocchetta in acciaio speciale temprato antitrapano"	VBN	•	1



MANIGLIONI

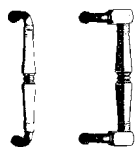

		FINITURA	€	
040 MD 003	Maniglione Diritto Singolo con rosetta 003 Ø45x7	VBN	•	2
040 MD 006	Maniglione Diritto Singolo con rosetta 006 Ø50x8 tipo lusso	VBN	•	2
040 MD 202	Maniglione Diritto Singolo con rosetta 202 Ø52x9 con bordo	VBN	•	2
040 MS 003	Maniglione Spostato Singolo con rosetta 003 Ø45x7	VBN	•	2
040 MS 006	Maniglione Spostato Singolo con rosetta 006 Ø50x8 tipo lusso	VBN	•	2
040 MS 202	Maniglione Spostato Singolo con rosetta 202 Ø52x9 con bordo	VBN	•	2

BATTENTI



006 BA 73R	Battente "Giove" con rosetta 73R Ø72x9	VBN	•	1
013 BA 73R	Battente "Helios" con rosetta 73R Ø72x9		•	1

ARTICOLI VARI



003 BY ***	Bocchetta coprivite Ø45 foro yale	VBN	•	24
006 BY ***	Bocchetta coprivite tipo lusso Ø50 foro yale	VBN	•	24
007 BY ***	Bocchetta ovale stretta mm 67x27 foro yale	VBN	•	24
009 BY ***	Bocchetta ovale coprivite mm 62x32 foro yale	VBN	•	24
202 BY ***	Bocchetta Ø52 con bordo foro yale	VBN	•	24



520 PI 001	Placca incasso 152x40 con foro chiave	VBN	•	8
520 PI 002	Placca incasso 152x40 cieca	VBN	•	8
524 PI 001	Placca incasso tonda Ø 57 incasso Ø 48 con foro chiave	VBN	•	24
524 PI 002	Placca incasso tonda Ø 57 incasso Ø 48 cieca	VBN	•	24
525 PI	Frontalino di trascinamento Ø 29 incasso Ø 25	VBN	•	24
529 PI 001	Placca incasso Ø 48 con foro chiave	VBN	•	24
529 PI 002	Placca incasso Ø 48 cieca	VBN	•	24



506 CP 00A	Coppia placca incasso con nottolino ALTO q.6/8	VBN	•	4
508 CP***	Coppia placca incasso con nottolino GRANDE q.6/8	VBN	•	6
518 CP***	Coppia placca incasso con nottolino ad anello q.6/8	VBN	•	6
519 CP***	Coppia placca incasso con nottolino ad anello q.6/8	VBN	•	6
503 NO 003	Nottolino libero/occupato per wc con rosetta coprivite Ø 45x7	VBN	•	6
503 NO 006	Nottolino libero/occupato per wc con rosetta coprivite Ø 50x8 tipo lusso	VBN	•	6



503 NO 202	Nottolino libero/occupato per wc con rosetta coprivite Ø 50 con bordo	VBN	•	6
------------	---	-----	---	---

CAPPUCCI PER CERNIERE

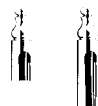

828AN013	Cappuccio per cerniera anuba ø13	VBN	•	24
828AN014	Cappuccio per cerniera anuba ø14	VBN	•	24
828AN016	Cappuccio per cerniera anuba ø16	VBN	•	24
829AN014	Cappuccio per cerniera anuba ø14	VBN	•	24
829AN016	Cappuccio per cerniera anuba ø16	VBN	•	24

SERIE CINZIA



		BN/VBN €	CHAMP/VBN €	
069 MP 040	Maniglia con placca 040 mm 244x40 con molla e grano	•	•	1
069 MR 004	Maniglia con rosetta 004 Ø45x9 con molla e grano	•	•	1
069 MR 006	Maniglia con rosetta 006 Ø50x8 tipo lusso con molla e grano	•	•	1
069 MR 007	Maniglia con rosetta 007 mm 67x27 ovale stretta con grano	•	•	1
069 MR 202	Maniglia con rosetta 202 mm Ø52x9 con bordo con grano	•	•	1
069 CR 040	Cremonese con placca 040 mm 174x37	•	•	2
069 MA 040	Martellina con placca 040 mm 174x37 q.7	•	•	2
069 DK 015	Dreh kipp con rosetta 015 mm 65x31 con movimento in metallo	•	•	3

Il trattamento speciale subito dal prodotto può causare piccole variazioni di tonalità nella finitura, non imputabili a difetto, bensì alla ricerca dell'ottenimento del migliore effetto di invecchiamento.

The special treatment of these products can lead to a small color variations on finish, that enhances its Vintage features.



BRONZO GRAFFIATO OPACO
MAT SCRATCHED BRONZED BRASS

COLLECTION





40 CR 040
40 MA 040



40 MP 040



40 MR 006



REGUCCI®



40 MR 007

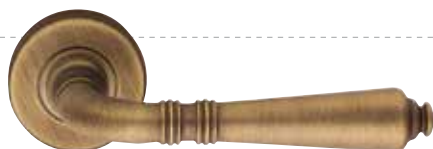

40 MR 004



40 MR 202





410 AT



411 NL

411 NT

411 NT

40 CR 063

411 NT

411 NL



40 DK 014



40 DK 015



T36 MR 006



94 MP 039



225 MP 248

BRONZOGRAFFIATOPACO
matscratchedbronzedbrass





171 MP 188



171 SE 070
171 SG 070



171 DK 015

REGUETTI®



800 MR 011



171 MP 248



171 MR 006



171 MR 004





T88 MR T36

destra/right



127 MP 248



127 DK 015



127 MR 004



BRONZOGRAFFIATOPACO
matscratchedbronzedbrass



272 MP 248

destra/right



272 DK 015



272 MR 004





69 MR 004 CHAMP/BGO



69 MR 006 BN/BGO



69 MR 006 DEC. H/BGO



69 MR 006 DEC. V/BGO

REGUCCI®



69 MR 006 DEC. C/BGO



69 MR 006 DEC. B/BGO





69 MP 040 CHAMP/BGO



69 CR 040 CHAMP/BGO
69 MA 040 CHAMP/BGO



69 DK 015 CHAMP/BGO



BRONZO**GRAFFIATO**TOPACO
matscratchedbronzedbrass



53 CR 040 CHAMP/BGO
53 MA 040 CHAMP/BGO



53 PR 004 CHAMP/BGO





828 AN



829 AN



40 MS 006



40 MD 004

REGUCCI®



320 MS 004



325 MS



320 MS



30 LD 000



200 MD



160 MD



BRONZOGRAFFIATOPACO
matscratchedbronzedbrass



30 MD 010



308 MD 001





E56 PF 002



G71 PF



E56 PR 004

REGUCCI®



346 PF 002



H56 PO 73R
H56 PF 73R



346 PR 006



13 BA 73R



6 BA 73R



646 TV

646 IN



BRONZOGRAFFIATOPACO
matscratchedbronzedbrass



121 PN 040



121 PN 034



121 PN 028



121 PN 022

007 BY



003 BY



202 BY



006 BY





531 CA



114 MT 096



70 SP 007



22 CH



552 CI

REGUETTI®



520 PI 002



524 PI 002



508 CP



525 PI



503 NO 004





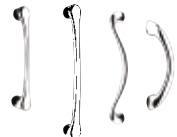
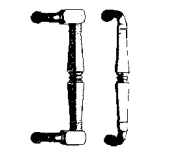

			FINITURA	€	
	040 MP 040	Maniglia con placca 040 mm 244x40 con molla e grano	BGO	•	1
	040 MP 026	Maniglia con placca 026 mm 225x26 stretta con grano	BGO	•	1
	040 MR 004	Maniglia con rosetta 004 ø45x9 con molla e grano	BGO	•	2
	040 MR 007	Maniglia con rosetta 007 mm 67x27 ovale stretta con grano	BGO	•	2
	040 MR 416	Maniglia con rosetta 416 ø45x9 con molla e grano	BGO	•	1
	040 MR 006	Maniglia con rosetta 006 ø50x8 tipo lusso con molla e grano	BGO	•	2
	040 MR 202	Maniglia con rosetta 202 ø52x9 con bordo con grano	BGO	•	2
	040 CR 040	Cremonese con placca 040 mm 174x37 con gioco	BGO	•	2
	040 MA 007	Martellina con rosetta 007 mm 67x27 ovale stretta q.7	BGO	•	2
	040 MA 040	Martellina con placca 040 mm 174x37 q.7	BGO	•	2
	040 DK 014	Dreh Kipp con rosetta 014 mm 80x35 con movimento in metallo	BGO	•	3
	040 DK 015	Dreh Kipp con rosetta 015 mm 65x31 con movimento in metallo	BGO	•	3
	040 DK 075	Dreh Kipp c/rosetta 075 mm 64x30 con mov. securblock e puls. di sicurezza	BGO	•	2
	040 CR 063	Cremonese con placca 063 mm 143x37 con gioco M.P. per aste esterne	BGO	•	2
	410 AT 150	Asta mm 7x16 lunghezza cm.150	BGO	•	12
	411 NL***	Solo finale mm 35x22	BGO	•	50
	411 NT***	Solo passante mm 35x22	BGO	•	50
	SERIE BERGEN				
	094 MP 039	Maniglia con placca 039 mm 255x50 con molla e grano	BGO	•	1
	094 MR 004	Maniglia con rosetta 004 ø45x9 con molla e grano	BGO	•	2
	094 MR 006	Maniglia con rosetta 006 ø50x8 tipo lusso con molla e grano	BGO	•	2
	094 MR 202	Maniglia con rosetta 202 ø52x9 con bordo con grano	BGO	•	2
	094 MR 416	Maniglia con rosetta 416 ø45x9 con molla e grano	BGO	•	1
	SERIE LORY				
	127 MP 188	Maniglia con placca 188 mm 255x42 con molla e grano	BGO	•	1
	127 MP 248	Maniglia con placca 248 mm 248x50 con molla e grano	BGO	•	1
	127 MR 004	Maniglia con rosetta 004 ø45x9 con molla e grano	BGO	•	2
	127 MR 006	Maniglia con rosetta 006 ø50x8 tipo lusso con molla e grano	BGO	•	1
	127 MR 416	Maniglia con rosetta 416 ø45x9 con molla e grano	BGO	•	1
	127 SG 070	Cremonese con placca 070 mm 173x40 coprivite con gioco	BGO	•	2
	127 SE 070	Martellina con placca 070 mm 173x40 coprivite q.7	BGO	•	2
	127 DK 015	Dreh kipp destro con rosetta 015 mm 65x31 con movimento in metallo	BGO	•	3
	SERIE ALISE'				
	171 MP 188	Maniglia con placca 188 mm 255x42 con molla e grano	BGO	•	1
	171 MP 248	Maniglia con placca 248 mm 248x50 con molla e grano	BGO	•	1
	171 MR 004	Maniglia con rosetta 004 ø45x9 con molla e grano	BGO	•	2
	171 MR 006	Maniglia con rosetta 006 ø50x8 tipo lusso con molla e grano	BGO	•	2
	171 MR 416	Maniglia con rosetta 416 ø45x9 con molla e grano	BGO	•	1
	171 SG 070	Cremonese con placca 070 mm 173x40 coprivite con gioco	BGO	•	2
	171 SE 070	Martellina con placca 070 mm 173x40 coprivite q.7	BGO	•	2
	171 DK 015	Dreh Kipp con rosetta 015 mm 65x31 con movimento in metallo	BGO	•	3
	SERIE MIRIAM				
	225 MP 188	Maniglia con placca 188 mm 255x42 con molla e grano	BGO	•	1
	225 MP 248	Maniglia con placca 248 mm 248x50 con molla e grano	BGO	•	1
	225 MR 006	Maniglia con rosetta 006 ø50x8 tipo lusso con molla e grano	BGO	•	1
	225 MR 416	Maniglia con rosetta 416 ø45x9 con molla e grano	BGO	•	1
	225 SG 070	Cremonese con placca 070 mm 173x40 coprivite con gioco	BGO	•	2
	225 SE 070	Martellina con placca 070 mm 173x40 coprivite q.7	BGO	•	2
	225 DK 015	Dreh kipp destro con rosetta 015 mm 65x31 con movimento in metallo	BGO	•	3
	SERIE SOFFIO				
	272 MP 188	Maniglia con placca 188 mm 255x42 con molla e grano	BGO	•	1
	272 MP 248	Maniglia con placca 248 mm 248x50 con molla e grano	BGO	•	1
	272 MR 004	Maniglia con rosetta 004 ø45x9 con molla e grano	BGO	•	2
	272 MR 006	Maniglia con rosetta 006 ø50x8 tipo lusso con molla e grano	BGO	•	2
	272 MR 416	Maniglia con rosetta 416 ø45x9 con molla e grano	BGO	•	1
	272 SG 070	Cremonese con placca 070 mm 173x40 coprivite con gioco	BGO	•	2
	272 SE 070	Martellina con placca 070 mm 173x40 coprivite q.7	BGO	•	2
	272 DK 015	Dreh kipp destro con rosetta 015 mm 65x31 con movimento in metallo	BGO	•	3

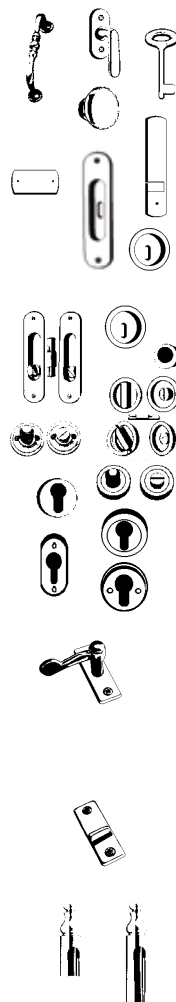

			FINITURA	€	
SERIE EPOCA					
800 MP 039	Maniglia con placca 039 mm 255x50 con molla e grano	BGO	•	1	
800 MP 040	Maniglia con placca 040 mm 244x40 con molla e grano	BGO	•	1	
800 MP 026	Maniglia con placca 026 mm 225x26 stretta con grano	BGO	•	1	
800 MR 004	Maniglia con rosetta 004 ø45x9 con molla e grano	BGO	•	1	
800 MR 006	Maniglia con rosetta 006 ø50x8 tipo lusso con molla e grano	BGO	•	1	
800 MR 011	Maniglia con rosetta 011 ø53x10 tipo lusso con molla e grano	BGO	•	1	
800 DK 014	Dreh Kipp con rosetta 014 mm 80x35 con movimento in metallo	BGO	•	3	
800 DK 015	Dreh kipp destro con rosetta 015 mm 65x31 con movimento in metallo	BGO	•	3	
800 DK 075	Dreh Kipp c/rosetta 075 mm 64x30 con mov. securblock e puls. di sicurezza	BGO	•	2	
SERIE TUSCANIA					
T36 MR 006	Maniglia con rosetta 006 ø50x8 tipo lusso con molla e grano	BGO	•	1	
T36 MR 007	Maniglia con rosetta 007 mm 67x27 ovale stretta con grano	BGO	•	2	
T36 MR 416	Maniglia con rosetta 416 Ø45x9 con molla e grano	BGO	•	1	
T36 MR T36	Maniglia con rosetta T36 mm ø45x9 con bordo	BGO	•	2	
SERIE ELBA					
T88 MR 007	Maniglia con rosetta 007 mm 67x27 ovale stretta con grano	BGO	•	2	
T88 MR 009	Maniglia con rosetta 009 mm 62x32 ovale con molla e grano	BGO	•	1	
T88 MR 202	Maniglia con rosetta 202 Ø52x9 con bordo con grano	BGO	•	2	
T88 MR T36	Maniglia con rosetta T36 mm ø45x9 con bordo	BGO	•	2	
MANIGLIONI					
040 MS 004	Maniglione Spostato Singolo con rosetta 004 ø45x9	BGO	•	2	
040 MS 006	Maniglione Spostato Singolo con rosetta 006 ø50x8 tipo lusso	BGO	•	2	
040 MS 202	Maniglione Spostato Singolo con rosetta 202 ø52x9 con bordo	BGO	•	2	
040 MD 004	Maniglione Diritto Singolo con rosetta 004 ø45x9	BGO	•	2	
040 MD 006	Maniglione Diritto Singolo con rosetta 006 ø50x8 tipo lusso	BGO	•	2	
040 MD 202	Maniglione Diritto Singolo con rosetta 202 ø52x9 con bordo	BGO	•	2	
160 MD	Maniglione Diritto	BGO	•	2	
200 MD	Maniglione Diritto	BGO	•	2	
320 MS	Maniglione Spostato Singolo	BGO	•	2	
320 MS 004	Maniglione Spostato Singolo con rosetta 004 ø45x9	BGO	•	2	
320 MS 006	Maniglione Spostato Singolo con rosetta 006 ø50x8 tipo lusso	BGO	•	2	
325 MS	Maniglione Spostato Singolo	BGO	•	1	
030 MD 001	Maniglione Diritto Singolo con placca cieca e con nicchia	BGO	•	1	
030 MD 010	Maniglione Diritto Singolo con placca yale e nicchia	BGO	•	1	
030 LD 000	Coppia Maniglioni con placca yale, senza nicchia	BGO	•	1	
308 MD 001	Maniglione Diritto Singolo con placca cieca e con nicchia	BGO	•	1	
308 MD 010	Maniglione Diritto Singolo con placca yale e nicchia	BGO	•	1	
308 LD 000	Coppia Maniglioni con placca yale, senza nicchia	BGO	•	1	
BATTENTI					
006 BA 73R	Battente "Giove" con rosetta 73R ø72x9	BGO	•	1	
006 BA 002	Battente "Giove" con rosetta 002 mm ø45x10	BGO	•	1	
013 BA 73R	Battente "Helios" con rosetta 73R ø72x9	BGO	•	1	
POMOLO SERIE COSMO					
E56 PR 004	Coppia Pomolo ø60 con rosetta 004 ø45x9 con grano	BGO	•	2	
E56 PR 006	Coppia Pomolo ø60 con rosetta 006 ø50x8 tipo lusso con grano	BGO	•	2	
E56 PR 202	Coppia Pomolo ø60 con rosetta 202 ø52x9 con bordo	BGO	•	2	
E56 PF 002	Pomolo Fisso ø60 con rosetta 002 mm ø45x10 con piastrina	BGO	•	4	
E56 PF 73R	Pomolo Fisso ø60 con rosetta 73R ø72x9 con piastrina	BGO	•	4	
H56 PO73R	Pomolo Fisso ø75 con rosetta 73R ø72x9 con troncone filettato	BGO	•	2	
H56 PF 002	Pomolo Fisso ø75 con rosetta 002 mm ø45x10 con piastrina	BGO	•	2	
H56 PF 73R	Pomolo Fisso ø75 con rosetta 73R ø72x9 con piastrina	BGO	•	2	
POMOLO SERIE UNICO					
G71 PF	Pomolo Fisso ø70 con piastrina	BGO	•	4	
071 RO	Rosetta ø70 per pomolo G71PF	BGO	•	2	
POMOLO SERIE ATLANTIDE					
346 PR 004	Coppia Pomolo con rosetta 004 ø45x9	BGO	•	2	
346 PR 006	Coppia Pomolo con rosetta 006 ø50x8 tipo lusso con grano	BGO	•	2	
346 PF 002	Pomolo Fisso con rosetta 002 mm ø45x10 con piastrina	BGO	•	2	



ARTICOLI VARI

		FINITURA	€	
114 MT 096	Manettoncino int. mm. 96 fil. 4MA	BGO	•	12
070 SP 007	Segretino piccolo con rosetta mm 67x27 q. 6/7/8	BGO	•	25
022 CH***	Chiave ovale mm 37x85	BGO	•	24
121 PN 022	Pomolino Spidy mm. 22	BGO	•	24
121 PN 028	Pomolino Spidy mm. 28	BGO	•	24
121 PN 034	Pomolino Spidy mm. 34	BGO	•	24
121 PN 040	Pomolino Spidy mm. 40	BGO	•	12
531 CA***	Copriavvolgibile universale	BGO	•	12
550 CI***	Coprinterruttore "Ticino Magic" cieco o a 1 - 2 - 3 tasti	BGO	•	8
520 PI 001	Placca incasso mm 152x40 con foro chiave	BGO	•	8
520 PI 002	Placca incasso mm 152x40 cieca	BGO	•	8
524 PI 001	Placca incasso tonda ø57 incasso ø48 con foro chiave.	BGO	•	24
524 PI 002	Placca incasso tonda ø57 incasso ø48 cieca	BGO	•	24
525 PI	Frontalino di trascinamento ø29 incasso ø25	BGO	•	24
506 CP 00A	Coppia placca incasso con nottolino ALTO q. 6/8	BGO	•	6
508 CP***	Coppia placca incasso con nottolino GRANDE q. 6/8	BGO	•	6
519 CP***	Coppia placca incasso con nottolino ad anello q. 6/8	BGO	•	6
503 NO 004	Nottolino libero/occupato per wc con rosetta coprivite ø45x9	BGO	•	6
503 NO 202	Nottolino libero/occupato per wc con rosetta 202 ø52x9 con bordo	BGO	•	6
503 NO 006	Nottolino libero/occupato per wc con rosetta 006 ø50x8 tipo lusso	BGO	•	6
003 BY***	Bocchetta coprivite ø45 foro yale	BGO	•	24
006 BY***	Bocchetta coprivite tipo lusso ø50 foro yale	BGO	•	24
007 BY***	Bocchetta ovale stretta mm 67x27 foro yale	BGO	•	24
202 BY***	Bocchetta ø52 con bordo foro yale	BGO	•	24
646TV000	Tavellino alt.00 a filo - senza incontro	BGO	•	25
646TV010	Tavellino mm.10 - senza incontro	BGO	•	25
646TV015	Tavellino mm.15 - senza incontro	BGO	•	25
646TV018	Tavellino mm.18 - senza incontro	BGO	•	25
646TV020	Tavellino mm.20 - senza incontro	BGO	•	25
646TV022	Tavellino mm.22 - senza incontro	BGO	•	25
646TV025	Tavellino mm.25 - senza incontro	BGO	•	25
646TV030	Tavellino mm.30 - senza incontro	BGO	•	25
646IN	Incontro a filo per tavellino art.646	BGO	•	25
CAPPUCCI PER CERNIERE				
828AN013	Cappuccio per cerniera anuba ø13	BGO	•	24
828AN014	Cappuccio per cerniera anuba ø14	BGO	•	24
828AN016	Cappuccio per cerniera anuba ø16	BGO	•	24
829AN014	Cappuccio per cerniera anuba ø14	BGO	•	24
829AN016	Cappuccio per cerniera anuba ø16	BGO	•	24

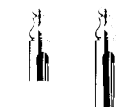
BN/BGO
€CHAMP/BGO
DECC/BGODEC.V/BGO
DEC.B/BGO
DEC.H/BGO

SERIE CINZIA

069 MP 040	Maniglia con placca 040 mm 244x40 con molla e grano	•	•	•	1
069 MR 004	Maniglia con rosetta 004 ø45x9 con molla e grano	•	•	•	1
069 MR 006	Maniglia con rosetta 006 ø50x8 tipo lusso con molla e grano	•	•	•	1
069 MR 202	Maniglia con rosetta 202 ø52x9 con bordo con grano	•	•	•	1
069 MR 416	Maniglia con rosetta 416 ø45x9 con molla e grano	•	•	•	1
069 CR 040	Cremonese con placca 040 mm 174x37 con gioco	•	•	-	2
069 MA 040	Martellina con placca 040 mm 174x37 q.7	•	•	-	2
069 DK 015	Dreh Kipp con rosetta 015 mm 65x31 con movimento in metallo	•	•	•	3
053 CR 040	Cremonese con placca 040 mm 174x37 con gioco	•	•	-	2
053 MA 040	Martellina con placca 040 mm 174x37 q.7	•	•	-	2
053 PR 004	Coppia Pomolo con rosetta 004 ø45x9 con grano	•	•	-	2
053 PR 006	Coppia Pomolo con rosetta 006 ø50x8 tipo lusso con grano	•	•	-	2



RAMATO VINTAGE
VINTAGE COPPERED

COLLECTION





40 MR 006



40 MR 202



40 DK 015

REGUCCI®



H57 PF 73R



H56 PF 73R



6 BA 73R



319 MS 006



40 MS 202









40 MD 006



OTTONE RAMATO
vintage coppered



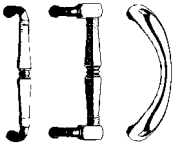

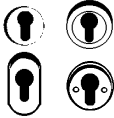
			FINITURA	€	
SERIE GINEVRA					
	040 MP 040	Maniglia con placca 040 mm 244x40 con molla e grano	RAM	•	1
	040 MR 006	Maniglia con rosetta 006 mm ø50x8 tipo lusso con molla e grano	RAM	•	2
	040 MR 009	Maniglia con rosetta 009 mm 62x32 ovale stretta con molla e grano	RAM	•	1
	040 MR 202	Maniglia con rosetta 202 ø52x9 con bordo con grano	RAM	•	2
	040 MR 416	Maniglia con rosetta 416 ø45x9 con molla e grano	RAM	•	1
	040 CR 040	Cremonese con placca 040 mm 174x37 con gioco	RAM	•	2
	040 MA 040	Martellina con placca 040 mm 174x37 q. 7	RAM	•	2
	040 DK 015	Dreh Kipp con rosetta 015 mm 65x31 con movimento in metallo	RAM	•	3
POMOLO SERIE COSMO					
	E56 PR 006	Coppia Pomolo ø60 con rosetta 006 ø50x8 tipo lusso con grano	RAM	•	2
	E56 PR 406	Coppia Pomolo ø60 con rosetta 406 ø45x9 con molla e grano	RAM	•	2
	E56 PF 73R	Pomolo Fisso ø60 con rosetta 73R ø72x9 con piastrina	RAM	•	4
	H56 PF 73R	Pomolo Fisso ø75 con rosetta 73R ø72x9 con piastrina	RAM	•	2
POMOLO SERIE MARGHERITA					
	H57 PF 73R	Pomolo Fisso ø75 con rosetta 73R ø72x9 con piastrina	RAM	•	2
MANIGLIONE SERIE GINEVRA					
	040 MD 004	Maniglione Diritto Singolo con rosetta 004 ø45x9	RAM	•	2
	040 MD 006	Maniglione Diritto Singolo con rosetta 006 ø50x8 tipo lusso	RAM	•	2
	040 MD 202	Maniglione Diritto Singolo con rosetta 202 ø52x9 con bordo	RAM	•	2
	040 MS 004	Maniglione Spostato Singolo con rosetta 004 ø45x9	RAM	•	2
	040 MS 006	Maniglione Spostato Singolo con rosetta 006 ø50x8 tipo lusso	RAM	•	2
	040 MS 202	Maniglione Spostato Singolo con rosetta 202 ø52x9 con bordo	RAM	•	2
	319 MS 006	Maniglione Spostato Singolo con rosetta 006 ø50x8 tipo lusso	RAM	•	1
BATTENTI					
	006 BA 73R	Battente "Giove" con rosetta 73R ø72x9	RAM	•	1
ARTICOLI VARI					
	003 BY	Bocchetta coprivite ø45 foro yale	RAM	•	24
	006 BY	Bocchetta coprivite tipo lusso ø50 foro yale	RAM	•	24
	009 BY	Bocchetta ovale coprivite mm 62x32 foro yale	RAM	•	24
	202 BY	Bocchetta ø52 con bordo foro yale	RAM	•	24



Il trattamento speciale subito dal prodotto può causare piccole variazioni di tonalità nella finitura, non imputabili a difetto, bensì alla ricerca dell'ottenimento del migliore effetto di invecchiamento.

The special treatment of these products can lead to a small color variations on finish, that enhances its Vintage features.

COLLECTION

ottone LUCIDO naturale
NATURAL BRASS





40 MP 040



40 DK 014



40 DK 015



40 CR 040
40 MA 040

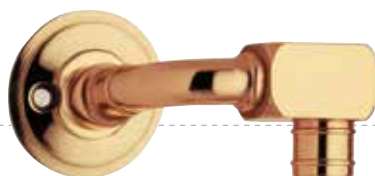

REGUITTI®



411 NT



410 AT



190 CR 063



40 MR 202



411 NL

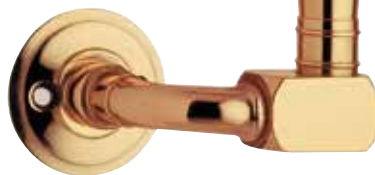

40 MS 202

REGUITTI®
Maniglie & Accessori



T33 MR T33



46 MR T33



6 BA 73R



T36 MR T36



13 BA 73R



T88 MR 007



TONELUCIDONATURALE
naturalbrass



E57 PR 202



E56 PR 202



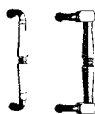
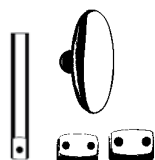
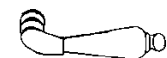

SERIE GINEVRA

040 MP 040	Maniglia con placca 040 mm 244x40 con molla e grano	LR	•	1
040 MR 004	Maniglia con rosetta 004 mm Ø45x9 con molla e grano	LR	•	2
040 MR 202	Maniglia con rosetta 202 Ø52x9 con bordo con grano	LR	•	2
040 CR 040	Cremonese con placca 040 mm 174x37 con gioco	LR	•	2
040 MA 040	Martellina con placca 040 mm 174x37 q. 7	LR	•	2
040 DK 014	Dreh Kipp con rosetta 014 mm 80x35 con movimento in metallo	LR	•	3
040 DK 015	Dreh Kipp con rosetta 015 mm 65x31 con movimento in metallo	LR	•	3
040 DK 075	Dreh Kipp c/rosetta 075 mm 64x30 con mov. securblock e puls. di sicurezza	LR	•	2

SERIE MARY

046 MR 202	Maniglia con rosetta 202 ø52x9 con bordo con grano	LR	•	2
046 MR T33	Maniglia con rosetta T33 ø37x5 con bordo con grano	LR	•	2
046 MR T36	Maniglia con rosetta T36 ø45x9 con bordo con grano	LR	•	2
046 DK 015	Dreh Kipp con rosetta 015 mm 65x31 con movimento in metallo	LR	•	3

SERIE MIGNON

T33 MR 007	Maniglia con rosetta 007 mm 67x27 ovale stretta	LR	•	2
T33 MR T33	Maniglia con rosetta T33 ø37x5 con bordo con grano	LR	•	2
T33 DK 015	Dreh Kipp con rosetta 015 mm 65x31 con movimento in metallo	LR	•	3

SERIE TUSCANIA

T36 MR 006	Maniglia con rosetta 006 ø50x8 tipo lusso con molla e grano	LR	•	1
T36 MR 007	Maniglia con rosetta 007 mm 67x27 ovale stretta con grano	LR	•	2
T36 MR 416	Maniglia con rosetta 416 Ø45x9 con molla e grano	LR	•	1
T36 MR T36	Maniglia con rosetta T36 mm ø45x9 con bordo	LR	•	2

SERIE ELBA

T88 MR 007	Maniglia con rosetta 007 mm 67x27 ovale stretta con grano	LR	•	2
T88 MR 009	Maniglia con rosetta 009 mm 62x32 ovale con molla e grano	LR	•	1
T88 MR 202	Maniglia con rosetta 202 Ø52x9 con bordo con grano	LR	•	2
T88 MR T36	Maniglia con rosetta T36 mm ø45x9 con bordo	LR	•	2

SERIE OVALINO

190 CR 063	Cremonese con placca 063 mm 143x37 con gioco M.P. per aste esterne	LR	•	2
410 AT 150	Asta mm 7x16 lunghezza cm.150	LR	•	12
410 AT 180	Asta mm 7x16 lunghezza cm.180	LR	•	12
410 AT 200	Asta mm 7x16 lunghezza cm.200	LR	•	12
411 NL***	Solo finale mm 35x22	LR	•	50
411 NT***	Solo passante mm 35x22	LR	•	50

POMOLO SERIE COSMO

E56 PR 003	Coppia Pomolo Ø60 con rosetta 003 Ø45x7 con grano	LR	•	2
E56 PR 202	Coppia Pomolo Ø60 con rosetta 202 Ø52x9 con bordo con grano	LR	•	2
H56 PF 73R	Pomolo Fisso Ø75 con rosetta 73R Ø72x9 con piastrina	LR	•	2
H56 PO 73R	Pomolo Fisso Ø75 con rosetta 73R Ø72x9 con troncone filettato	LR	•	2

POMOLO SERIE MARGHERITA

E57 PR 003	Coppia Pomolo Ø60 con rosetta 003 Ø45x7 con grano	LR	•	2
E57 PR 202	Coppia Pomolo Ø60 con rosetta 202 Ø52x9 con bordo con grano	LR	•	2
H57 PF 73R	Pomolo Fisso Ø75 con rosetta 73R Ø72x9 con piastrina	LR	•	2
H57 PO 73R	Pomolo Fisso Ø75 con rosetta 73R Ø72x9 con troncone filettato	LR	•	2

MANIGLIONE SERIE GINEVRA

040 MD 003	Maniglione Diritto Singolo con rosetta 003 Ø45x7	LR	•	2
040 MD 202	Maniglione Diritto Singolo con rosetta 202 Ø52x9 con bordo	LR	•	2
040 MS 003	Maniglione Spostato Singolo con rosetta 003 Ø45x7	LR	•	2
040 MS 202	Maniglione Spostato Singolo con rosetta 202 Ø52x9 con bordo	LR	•	2

BATTENTI

006 BA 73R	Battente "Giove" con rosetta 73R Ø 72x9	LR	•	1
013 BA 73R	Battente "Helios" con rosetta 73R Ø 72x9	LR	•	1

BOCCHETTA

003 BY ***	Bocchetta coprivite Ø45 foro yale	LR	•	24
006 BY ***	Bocchetta coprivite tipo lusso Ø50 foro yale	LR	•	24
007 BY ***	Bocchetta ovale stretta mm 67x27 foro yale	LR	•	24
009 BY ***	Bocchetta ovale coprivite mm 62x32 foro yale	LR	•	24
202 BY ***	Bocchetta Ø52 con bordo foro yale	LR	•	24

FINITURA

€



ottone nero California
BLACK CALIFORNIA BRASS

COLLECTION





40 MP 040



40 CR 040
40 MA 040



40 DK 015



821 AN 014

REGUETTI®



94 MR 202



829 AN 014



40 MR 202

REGUETTI®
Maniglie & Accessori



7 BA R56



E56 PF R56



121 PN



40 MD 202



40 MS 202



OTTONE **NERO CALIFORNIA**
blackcalifornia brass



646 TV

646 IN



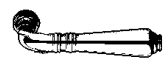

SERIE GINEVRA

		FINITURA	€	
040 MP 040	Maniglia con placca 040 mm 244x40 con molla	NC	•	1
040 MP 040	Maniglia con placca 040 mm 244x40 con molla e grano	NC	•	1
040 MR 006	Maniglia con rosetta 006 Ø50x8 tipo lusso con molla e grano	NC	•	2
040 MR 007	Maniglia con rosetta 007 mm 67x27 ovale stretta con grano	NC	•	2
040 MR 009	Maniglia con rosetta 009 mm 62x32 ovale stretta con molla e grano	NC	•	1
040 MR 202	Maniglia con rosetta 202 Ø52x9 con bordo con grano	NC	•	2
040 CR 040	Cremonese con placca 040 mm 174x37 con gioco	NC	•	2
040 MA 040	Martellina con placca 040 mm 174x37 q. 7	NC	•	2
040 DK 015	Dreh Kipp con rosetta 015 mm 65x31 con movimento in metallo	NC	•	3

SERIE BERGEN



094 MR 006	Maniglia con rosetta 006 Ø50x8 tipo lusso con molla e grano	NC	•	2
094 MR 202	Maniglia con rosetta 202 Ø52x9 con bordo con grano	NC	•	2
094 DK 015	Dreh Kipp con rosetta 015 mm 65x31 con movimento in metallo	NC	•	3

POMOLO SERIE COSMO



E56 PR 006	Coppia Pomolo Ø60 con rosetta 006 Ø50x8 tipo lusso con grano	NC	•	2
E56 PR 202	Coppia Pomolo Ø60 con rosetta 202 Ø52x9 con bordo con grano	NC	•	2
H56 PO R56	Pomolo Fisso Ø75 con rosetta R56 Ø70x7 con troncone filettato	NC	•	2
E56 PF R50	Pomolo Fisso Ø60 con rosetta R50 Ø50x9 con piastrina	NC	•	4
E56 PF R56	Pomolo Fisso Ø60 con rosetta R56 Ø70x7 con piastrina	NC	•	4
H56 PF R50	Pomolo Fisso Ø75 con rosetta R50 Ø50x9 con piastrina	NC	•	2
H56 PF R56	Pomolo Fisso Ø75 con rosetta R56 Ø70x7 con piastrina	NC	•	2

MANIGLIONE SERIE GINEVRA

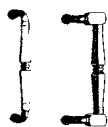

040 MD 006	Maniglione Diritto Singolo con rosetta 006 Ø50x8 tipo lusso	NC	•	2
040 MD 202	Maniglione Diritto Singolo con rosetta 202 Ø52x9 con bordo	NC	•	2
040 MS 006	Maniglione Spostato Singolo con rosetta 006 Ø50x8 tipo lusso	NC	•	2
040 MS 202	Maniglione Spostato Singolo con rosetta 202 Ø52x9 con bordo	NC	•	2

BATTENTE



007 BA R56	Battente "Europa" con rosetta R56 Ø70x7	NC	•	1
------------	---	----	---	---

POMOLINI



121 PN 022	Pomolino Spidy mm 22	NC	•	24
121 PN 028	Pomolino Spidy mm 28	NC	•	24
121 PN 034	Pomolino Spidy mm 34	NC	•	24
121 PN 040	Pomolino Spidy mm 40	NC	•	24

BOCCHETTA



006 BY ***	Bocchetta coprivite tipo lusso Ø50 foro yale	NC	•	24
202 BY ***	Bocchetta Ø52 con bordo foro yale	NC	•	24

ARTICOLI VARI



503 NO 202	Nottolino libero/occupato per wc con rosetta 202 ø52x9 con bordo	NC	•	25
503 NO 006	Nottolino libero/occupato per wc con rosetta 006 ø50x8 tipo lusso	NC	•	25
646TV000	Tavellino alt.00 a filo - senza incontro	NC	•	25
646TV010	Tavellino mm.10 - senza incontro	NC	•	25
646TV015	Tavellino mm.15 - senza incontro	NC	•	25
646TV018	Tavellino mm.18 - senza incontro	NC	•	25
646TV020	Tavellino mm.20 - senza incontro	NC	•	25
646TV022	Tavellino mm.22 - senza incontro	NC	•	25
646TV025	Tavellino mm.25 - senza incontro	NC	•	25
646TV030	Tavellino mm.30 - senza incontro	NC	•	25



646IN	Incontro a filo per tavellino art.646	NC	•	25
821AN014	Cappuccio per cerniera anuba Ø14	NC	•	24



829AN014	Cappuccio per cerniera anuba Ø14	NC	•	24
----------	----------------------------------	----	---	----





Elementia

art.800 Epoca



800 MR 011 BGO

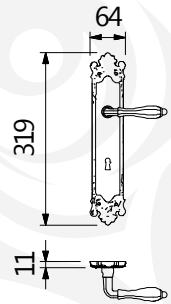

800 MP 198 BGO



800 MP 198 AN



800 MP 198 AGV

Elementia

art.900 Charme



900 MR 011 AGV

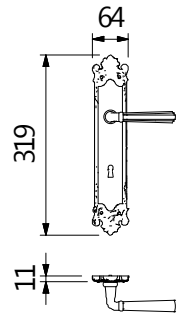

900 MP 198 BGO



900 MP 198 AN



900 MP 198 AGV

art.94 Bergen



94 MR 011 AN

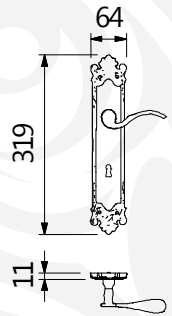

94 MP 198 AN



94 MP 198 BGO



94 MP 198 AGV

art.57 Margherita

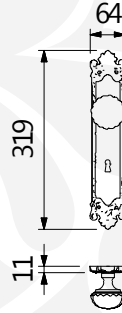

H57 PF 73R AN



E57 PR 202 AGV

E57 PP 198 AN
E57 PF 198 AN



E57 PP 198 AGV
E57 PF 198 AGV

VERSIONI / VERSIONS

Finiture
Finishes



AN

AGV



BGO





ART. 94 BERGEN

					€	€	€		
	094 MP 198	Maniglia con placca <i>Handle on plate</i>	198	319 x 64 mm	con molla <i>with spring</i>	•	•	•	1
	094 MR 011	Maniglia con rosetta <i>Lever handle on rose</i>	011	ø 53x10	tipo lusso con molla <i>with spring</i>	•	•	•	1

ART. 800 EPOCA

					€	€	€		
	800 MP 198	Maniglia con placca <i>Handle on plate</i>	198	319 x 64 mm	con molla <i>with spring</i>	•	•	•	1
	800 MR 011	Maniglia con rosetta <i>Lever handle on rose</i>	011	ø 53x10	tipo lusso con molla <i>with spring</i>	•	•	•	1

ART. 900 CHARME

					€	€	€		
	900 MP 198	Maniglia con placca <i>Handle on plate</i>	198	319 x 64 mm	con molla <i>with spring</i>	•	•	•	1
	900 MR 011	Maniglia con rosetta <i>Lever handle on rose</i>	011	ø 53x10	tipo lusso con molla <i>with spring</i>	•	•	•	1



VERSIONI / VERSIONS



Finiture
Finishes



AN

AGV

BGO



ART. 57 MARGHRITA

						€	€	€	
	E57 PP 198	Coppia pomolo Ø 60 mm con placca <i>Pair knob Ø 60 mm on plate</i>	198	319 x 64 mm		•	•	•	1
	E57 PR 202	Coppia pomolo Ø 60 mm con rosetta <i>Pair knob Ø 60 mm on rose</i>	202	Ø 52 x 9 mm		•	•	•	1
	E57 PF 198	Pomolo fisso Ø 60 con placca <i>Fixed Ø 60 knob on plate</i>	198	319 x 64 mm	yale yale	•	•	•	1
	H57 PF 198	Pomolo fisso Ø 75 con placca <i>Fixed Ø 75 knob on plate</i>	198	319 x 64 mm	yale yale	•	•	•	1
	H57 PF 73R	Pomolo fisso Ø 75 con rosetta <i>Fixed Ø 75 knob on rose</i>	73R	Ø 72 x 9 mm	con piastrina <i>with fixing base</i>	•	•	•	1





FLAT LINE

Purezza decorativa integrata nella porta

Flat Line - Formula  Millimetro.....

Linea di maniglie con rosette e bocchette dal design "a filo" che esaltano la sporgenza della sola maniglia. Questa esclusiva creazione dona novità alle forme comprendendo anche i meccanismi di qualità (molla di ritorno).

Formula  : perchè è unico il sistema di rosetta "a filo" comprensivo di molla di ritorno per la maniglia.

 Millimetro: perchè con solo 1mm di spessore, la rosetta e la bocchetta Flat Line combinano al meglio funzionalità di montaggio e purezza estetica.

Flat Line - Formula  Millimeter.....

A hardware serie with roses in "flat-design" which distinguish only the overlap of the handle. This exclusive creation is demonstrating innovative form as well as respecting mechanisms of quality (returning spring)

Formula  : because the system of flat-rose with returning spring for the handle is unique

 Millimeter: because with only 1 mm thickness of the rose, Flat line combines best assembly functionally and purity of aesthetics.

REGUETTI[®]
Maniglie & Accessori

www.reguitti.it



reguitti@reguitti.it





119 MR J08 - OC

art. **119 Q-10**



Attenzione: **Foratura porta speciale**
Vedi info tecnica a fine capitolo



ART.				LV	OSC OC		
119 MR J08	Maniglia con rosetta <i>Lever Handle on rose</i>	J08	Ø 55 mm	con molla e grano <i>with spring and grub screw</i>	•	•	1
119 RW J08	Maniglia con rosetta <i>Lever Handle on rose</i>	J08	Ø 55 mm	con molla e nott. WC 503 <i>with spring and wc turn 503</i>	•	•	1

Flat Line - Formula  Millimetro



121 MR J08 - OC

art. **121** APRI



Attenzione: **Foratura porta speciale**
Vedi info tecnica a fine capitolo



ART.					LV	OSC OC	
121 MR J08	Maniglia con rosetta Lever Handle on rose	J08	Ø 55 mm	con molla e grano with spring and grub screw	•	•	1
121 RW J08	Maniglia con rosetta Lever Handle on rose	J08	Ø 55 mm	con molla e nott. WC 503 with spring and wc turn 503	•	•	1



130 MR JQ8 - OC

art. **130 LASER**



Attenzione: **Foratura porta speciale**
Vedi info tecnica a fine capitolo



ART.				OC OSC	
130 MR JQ8	Maniglia con rosetta <i>Lever Handle on rose</i>	JQ8 mm 55 x 55	con molla e grano <i>with spring and grub screw</i>	•	1
130 RW JQ8	Maniglia con rosetta <i>Lever Handle on rose</i>	JQ8 mm 55 x 55	con molla e nott. WC 503 <i>with spring and wc turn 503</i>	•	1



429 MR JQ8 - OC

art. **429 Q-STAR**



Attenzione: **Foratura porta speciale**
Vedi info tecnica a fine capitolo



ART.

429 MR JQ8	Maniglia con rosetta Lever Handle on rose	JQ8 mm 55 x 55
429 RW JQ8	Maniglia con rosetta Lever Handle on rose	JQ8 mm 55 x 55
429 RQ JQ8	Maniglia con rosetta Lever Handle on rose	JQ8 mm 55 x 55

con molla e grano
with spring and grub screw
con molla e nott. WC 503
with spring and wc turn 503
con molla e nott. WC 124
with spring and wc turn 124

OC
OSC



1
1
1

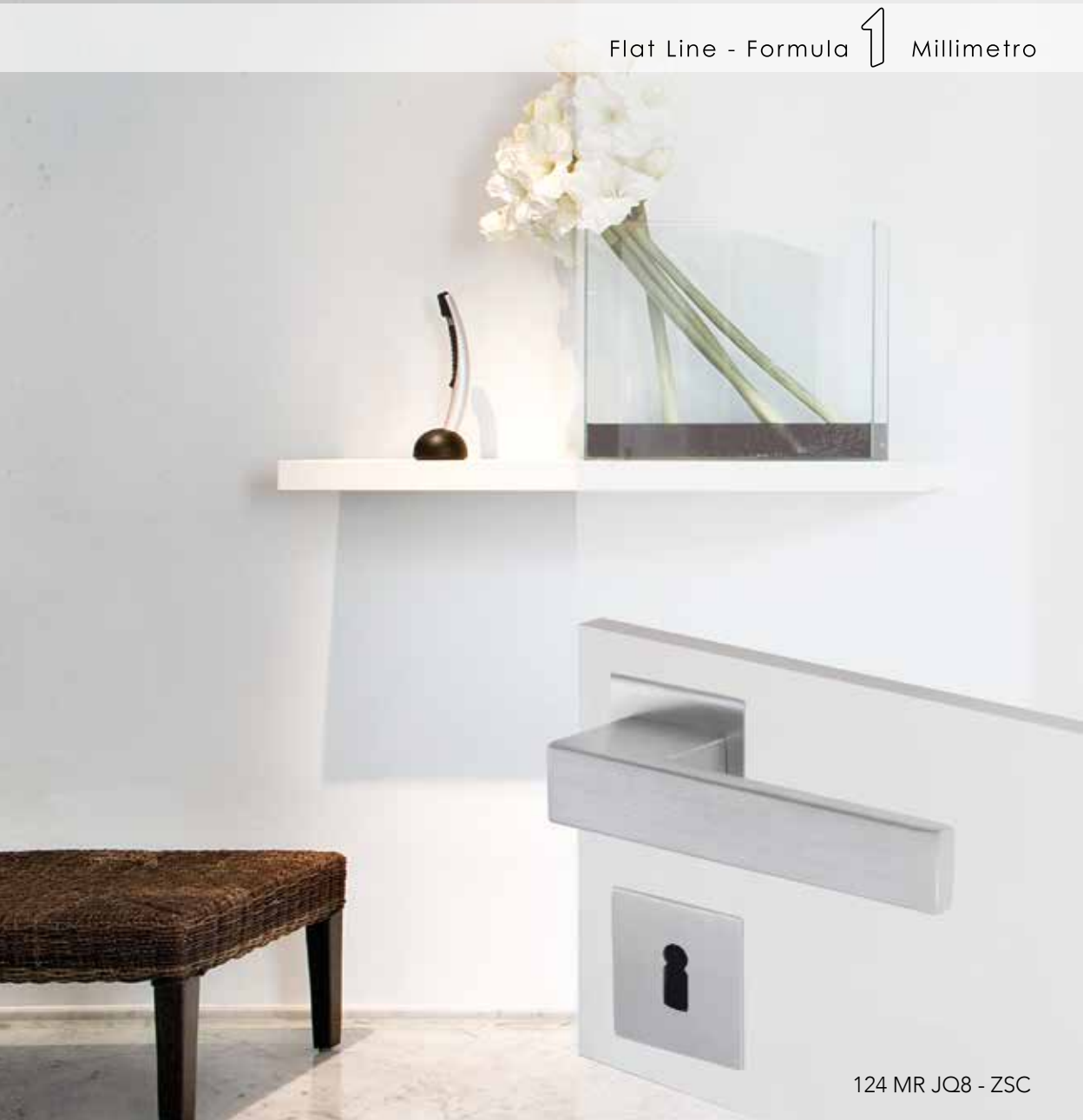

124 MR JQ8 - ZSC

art. **124 Q-ARTE**



Attenzione: **Foratura porta speciale**
Vedi info tecnica a fine capitolo



ART.			ZSC	SNV		
124 MR JQ8	Maniglia con rosetta Lever Handle on rose	JQ8 mm 55 x 55	con molla e grano with spring and grub screw	•	•	1
124 RW JQ8	Maniglia con rosetta Lever Handle on rose	JQ8 mm 55 x 55	con molla e nott. WC 503 with spring and wc turn 503	•	•	1

Flat Line - Formula  Millimetro



422 MR JQ8 - OC

art. 422 Q-UBIK



Attenzione: **Foratura porta speciale**
Vedi info tecnica a fine capitolo



ART.				OC OSC	
422 MR JQ8	Maniglia con rosetta Lever Handle on rose	JQ8 mm 55 x 55	con molla e grano with spring and grub screw	•	1
422 RW JQ8	Maniglia con rosetta Lever Handle on rose	JQ8 mm 55 x 55	con molla e nott. WC 503 with spring and wc turn 503	•	1

Flat Line - Formula



Millimetro

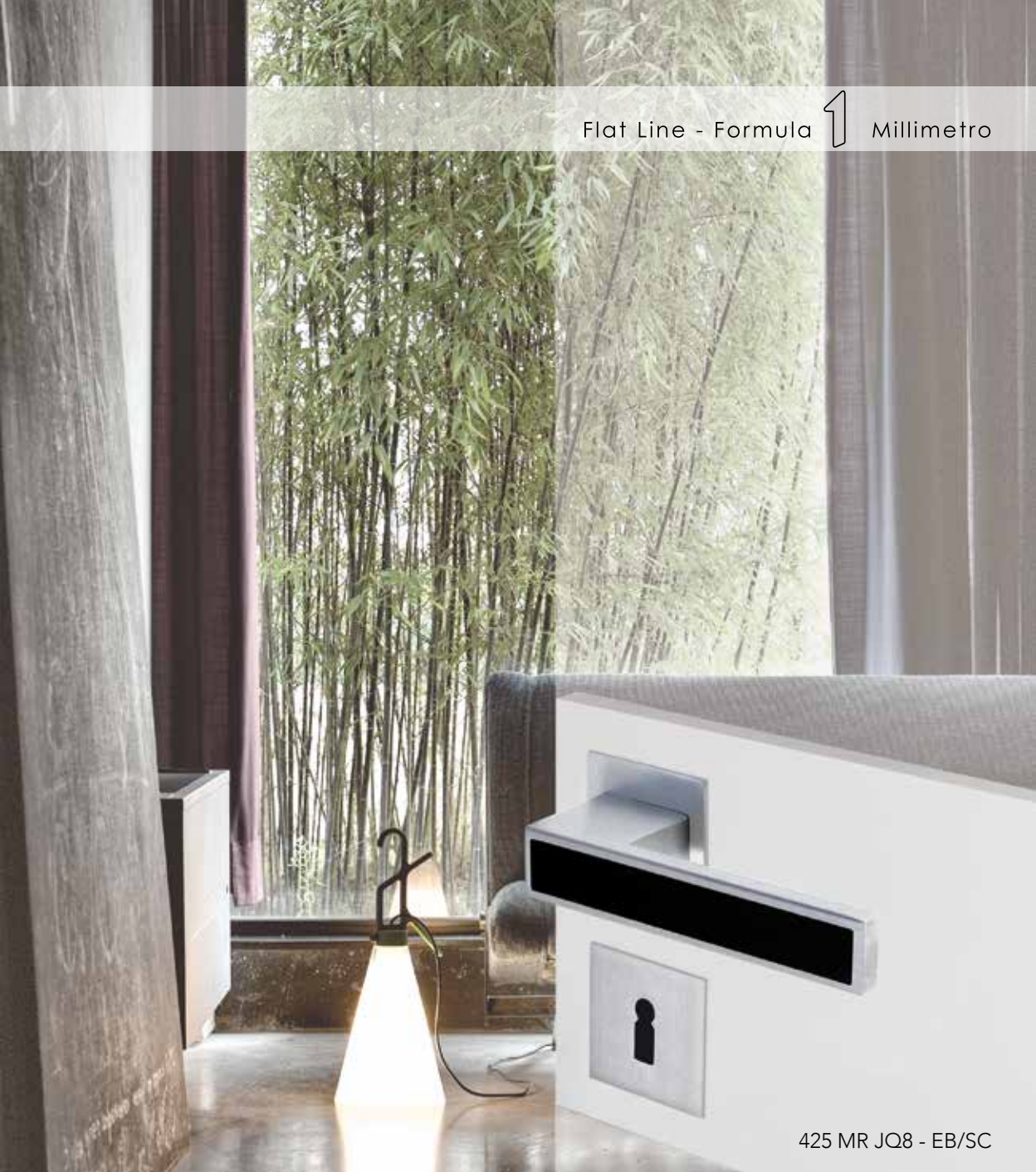

425 MR JQ8 - EB/SC

art. 425 Q-INSERT



Attenzione: **Foratura porta speciale**
Vedi info tecnica a fine capitolo



ART.				Ebano/Crom Wengè/Crom	Ebano/Sat crom Wengè/Sat crom	
425 MR JQ8	Maniglia con rosetta <i>Lever Handle on rose</i>	JQ8 mm 55 x 55	con molla e grano <i>with spring and grub screw</i>	•	•	1
425 RW JQ8	Maniglia con rosetta <i>Lever Handle on rose</i>	JQ8 mm 55 x 55	con molla e nott. WC 503 <i>with spring and wc turn 503</i>	•	•	1

Flat Line - Formula  Millimetro



124 MR JQ8 - SC/D4

art. **124** Q-ARTE Riga



Attenzione: **Foratura porta speciale**
Vedi info tecnica a fine capitolo



ART.		SC/D4	SNV/D4	
124 MR JQ8	Lever Handle on rose JQ8 mm 55 x 55 with spring and grub screw	•	•	1
124 RW JQ8	Lever Handle on rose JQ8 mm 55 x 55 with spring and wc turn 503	•	•	1

NOTTOLINI WC

WC TURN AND RELEASE

Flat Line - Formula  Millimetro



503NOJ08



503NOJQ8

Nott. per wc \varnothing 5,6,7 o 8

Wc turn and release with \varnothing 5,6,7 or 8

ART.

503 NO J08

Wc turn and release on rose J08 \varnothing 55 mm

503 NO JQ8

Wc turn and release on rose JQ8 55 x 55 mm



LV	OC OSC	SNV	
•	•	•	6
•	•	•	6

SET ROSETTE E BOCCHETTE

ROSETTES AND ESCUTCHEONS SET



CD J08 RO



CD J08 BN



CD J08 BY



CD JQ8 RO



CD JQ8 BN



CD JQ8 BY

ART.

CD J08 RO

Set 2 rosette tonde FLAT
Set 2 round flat roses

CD JQ8 RO

Set 2 rosette quadre FLAT
Set 2 square flat roses

CD J08 BN

Set 2 bocchette tonde FLAT
Set 2 round flat roses for key

CD JQ8 BN

Set 2 bocchette quadre FLAT
Set 2 square flat roses for key

CD J08 BY

Set 2 bocchette YALE tonde FLAT
Set 2 round flat roses for euro profile cylinder hole (yale)

CD JQ8 BY

Set 2 bocchette YALE quadre FLAT
Set 2 square flat roses for euro profile cylinder hole (yale)



LV	OC OSC	SNV	
•	•	•	1
-	•	•	1
•	•	•	1
-	•	•	1
•	•	•	1
-	•	•	1



Sistema FLAT:

abbinabile, a richiesta, a **TUTTE** le maniglie del Catalogo Reguitti
Flat System: suitable, on request, for all lever handles of Reguitti Catalogue

Extra prezzo:
Extra charge:

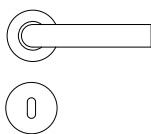

Maniglie con rosetta e
 bocchetta
 FLAT TONDA J08

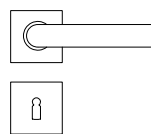

Maniglie con rosetta e
 bocchetta
 FLAT QUADRA JQ8



Maniglie con rosetta e
 bocchetta di serie
 005 - 006



Maniglie con rosetta e
 bocchetta di serie
 Q08 - Q86

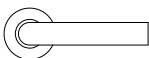

DETRAZIONE PER MANIGLIE SENZA BOCCHETTA *Amount to deduct for handles without key hole*

Finiture	Maniglie con rosetta e bocchetta FLAT TONDA J08	Maniglie con rosetta e bocchetta FLAT QUADRA JQ8
 LV		-
 OC OSC SNV		

INFO TECNICHE

Technical info

Flat Line - Formula 1 Millimetro

Componenti standard per porte spessore 38 - 45 mm
Standard components for door thickness 38 - 45 mm

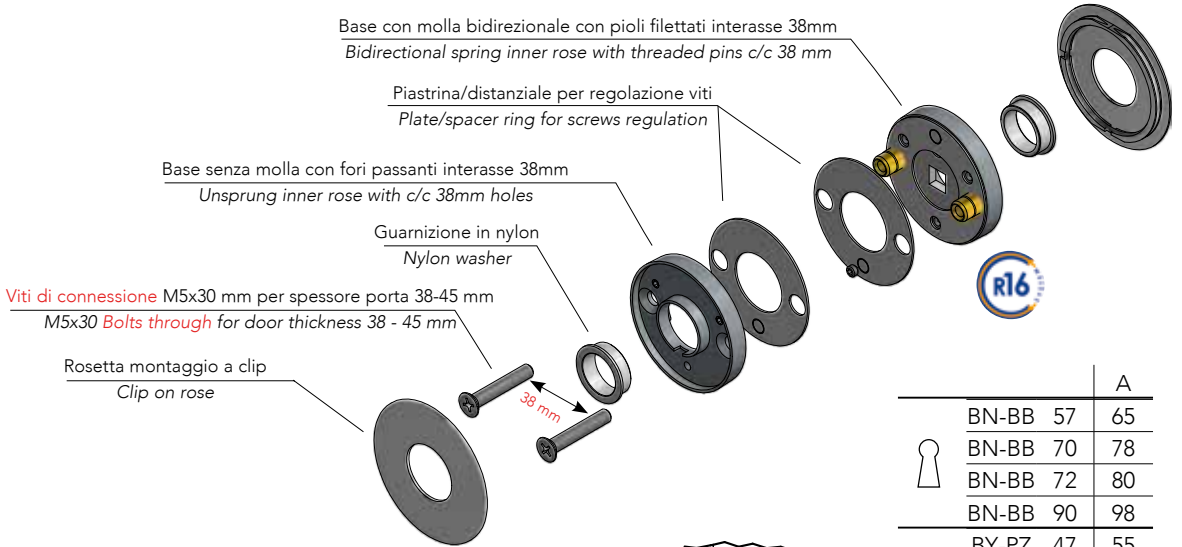

Specifiche tecniche pannello porta Door panel technical features

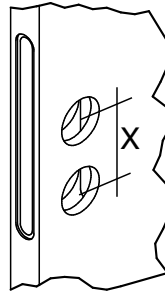

		A
	BN-BB 57	65
🔑	BN-BB 70	78
	BN-BB 72	80
	BN-BB 90	98
	BY-PZ 47	55
	BY-PZ 70	78
🔑	BY-PZ 72	80
	BY-PZ 85	93
	BY-PZ 90	98
	BY-PZ 92	100
	BY-PZ 78	86
🔧	WC 57	57
	WC 70	70
	WC 72	72
	WC 78	78
	WC 90	90

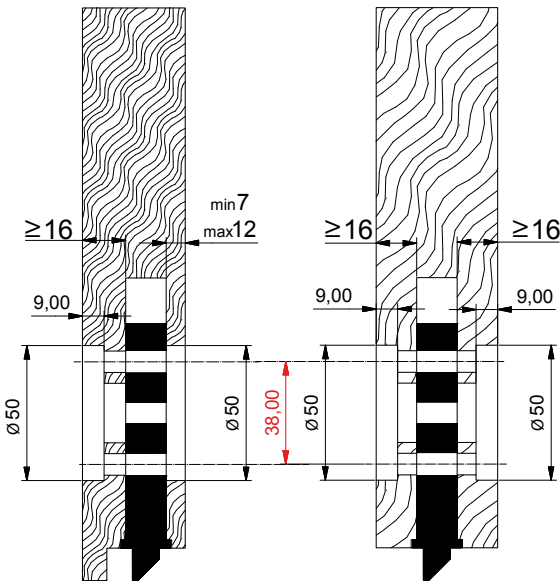

Für maßnahmen nicht indiziert
Per misure non indicate
For sizes not shown
Pour mesures pas indiquées
Para medida no no indicadas
A= BN-BB + mm 8
A= BY-PZ + mm 8
A= WC + mm 0

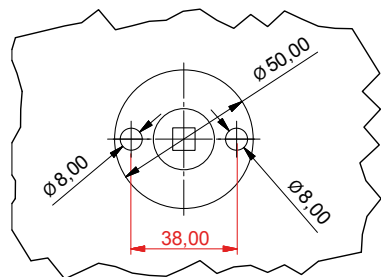

ISTRUZIONI DI MONTAGGIO

Assembling instructions

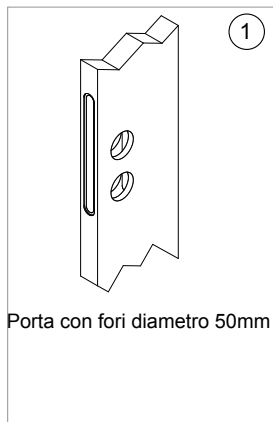

Porta con fori diametro 50mm



Montaggio della serratura e del ferro



Posizionare la piastrina "A" nel foro della maniglia

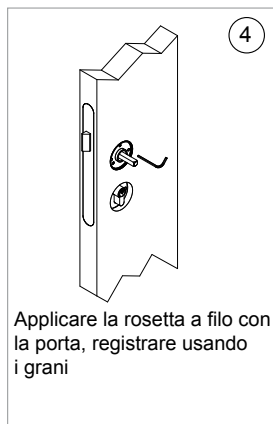

Applicare la rosetta a filo con la porta, registrare usando i grani

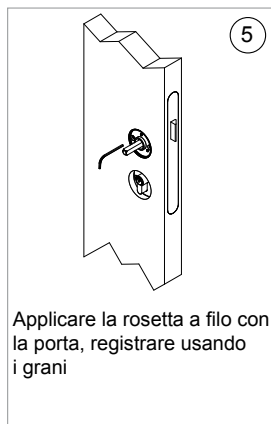

Applicare la rosetta a filo con la porta, registrare usando i grani



Fissare con le viti passanti

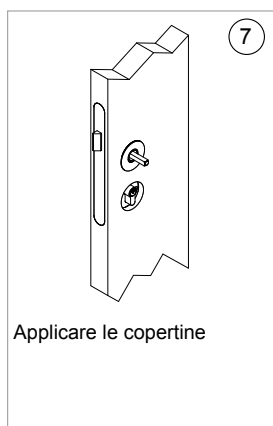

Applicare le copertine

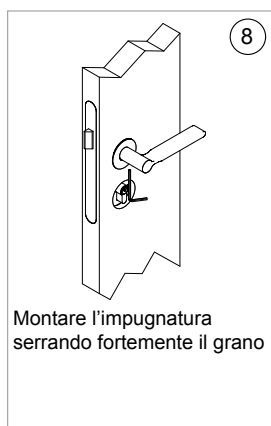

Montare l'impugnatura serrando fortemente il grano

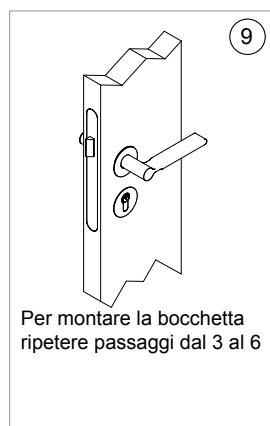

Per montare la bocchetta ripetere passaggi dal 3 al 6

A RICHIESTA

Utensile di foratura \varnothing 50 mm completo di ferro Q8 e punta tonda



VF50FS0TQ

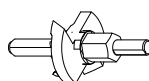

Valida anche per il sistema Minimal Line

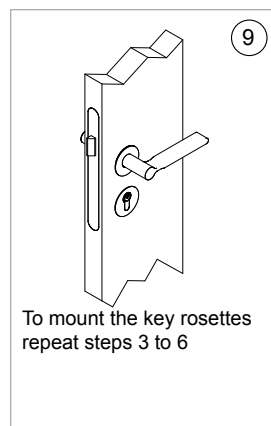
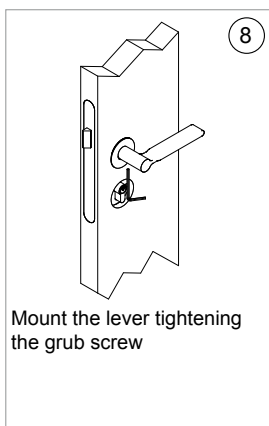
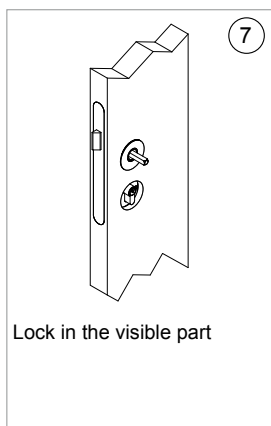
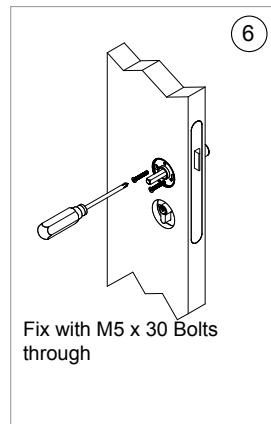
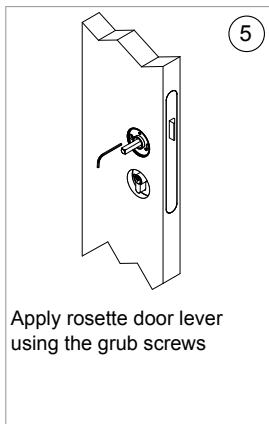
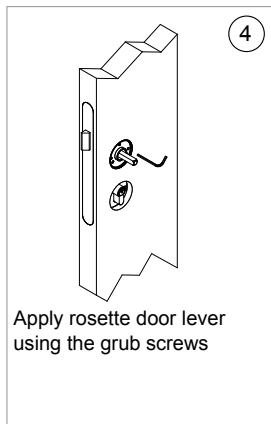
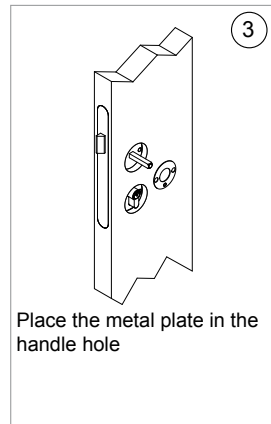
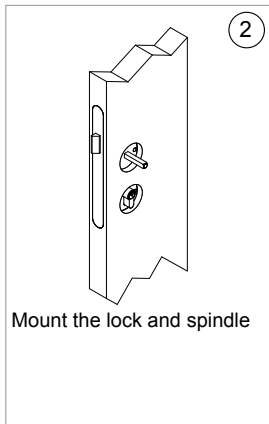
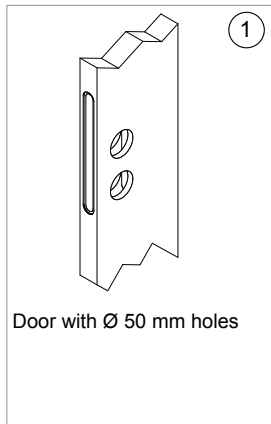

ON REQUEST

Ø 50 mm Drill miller
with 8x8 mm spindle and drill bit



VF50FS0TQ

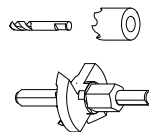

Suitable
also for
Minimal Line
system

art. 199 UNIQA

design: St. Reguitti - Mod.Dep.
materiale: Impugnatura Zama
material: Lever Zamak

DIMENSIONI MAGGIORATE FINO AL 50% RISPETTO A MANIGLIE TRADIZIONALI.
LETTERALMENTE UNA GRANDE MANIGLIA CREATA PER DARE MAGGIOR VALORE ALLA PORTA.

TeKnoMetal
Linea in zama

DESIGN MINIMALE MA DI EFFETTO.
UN PRODOTTO SEMPLICE, MODERNO MA PIÙ IMPORTANTE.

Increased size of up to 50% compared to traditional handles.
An OVERSIZED HANDLE properly designed to give better value to the door.
Minimal design but effective.
A simple, modern but more important product



RPM SYSTEM

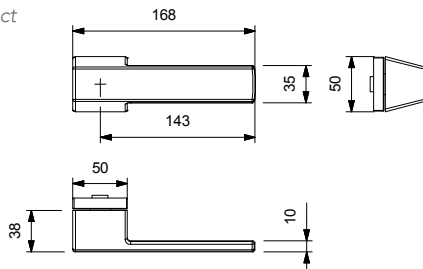

199 MR 199 - ZSC



199 RQ 199 - ZSC



199 SE Q90 - ZSC
199 SG Q90 - ZSC



199 DK Q15 - ZSC



199 DK Q75 - ZSC



MANIGLIA CON ROSETTA / LEVER HANDLE ON ROSE

					€	€	€	
	199 MR 199-71	Maniglia con rosetta Lever handle on rose	199 mm 50x50	RPM system c/molla e bocc.Q08 RPM system with spring and Q08 ros.for key	•	•	•	1
	199 MR 199-72	Maniglia con rosetta Lever handle on rose	199 mm 50x50	RPM system c/molla e bocc.Q08 yale RPM system with spring and Q08 yale	•	•	•	1
	199 MR 199-35	Maniglia con rosetta Lever handle on rose	199 mm 50x50	RPM system c/molla senza bocc. RPM system with spring without key rose	•	•	•	1

MANIGLIA CON ROSETTA E NOTTOLINO WC / LEVER HANDLE ON ROSE AND WC TURN

					€	€	€	
	199 RQ 199	Maniglia con rosetta Lever handle on rose	199 mm 50x50	RPM system e nott. wc 124 with RPM system and wc turn 124	•	•	•	1

MARTELLINA / WINDOW HANDLE WITHOUT MECHANISM

					€	€	€	
	199 SE Q90*	Martellina con placca Martellina on plate	Q90 mm 190x38	coprivite q.7 with cov.scr.plate and sq.-pin mm 7	•	•	•	2

CREMONESE / WINDOW HANDLE WITH MECHANISM

					€	€	€	
	199 SG Q90*	Cremonese con placca Cremon on plate	Q90 mm 190x38	coprivite con gioco with cover-screw plate with mechanism	•	•	•	2

DREH KIPP / DREH KIPP

					€	€	€	
	199 DK Q15	Dreh kipp con rosetta Dreh Kipp on rose	Q15 mm 65x31	con movimento in metallo with metal mechanism	•	•	•	2
	199 DK Q75	Dreh kipp con rosetta Dreh Kipp on rose	Q75 mm 64x30	con mov. securblock e puls. di sicurezza with securblock system and push button	•	•	•	2

L'ergonomia speciale di UNIQA
Special ergonomics of UNIQA



L'ergonomia delle dimensioni tradizionali
Ergonomics of common sizes



*Placca adatta a movimenti intercambiabili / Plate suitable to interchangeable movements

A RICHIESTA / ON REQUEST:

- Mezza maniglia con placca o con rosetta (specificare se destra o sinistra) / Half lever handle on plate or on rose (to specify if right or left)
- Coppie impugnature (CM) con grano e ferro senza rosette e senza bocchette / Pair levers (CM) with grub screws and square pin without rose and without rose for key

minimal line

Minimal Line

Linea di maniglie con rosette e bocchette prive di spessore che, pur donando alla guarnitura tutta la proiezione tipica del design dell'oggetto maniglia, riducono la sporgenza alla sola impugnatura; le stesse vengono ridotte a puro elemento decorativo quasi integrato nella porta. Questa esclusiva creazione unisce l'originalità delle forme alla perfezione funzionale dei meccanismi.

Minimal Line

This product line of hardware stands out due to the fact that the diameter of the rosettes is reduced to the substance. Therefore they have a small influence to the aesthetics of the door, because they are realized minimal only. With respect to the overall impression, however, the decorative element is limited to the essential and thus accents the modern concept of the no-design, for not affecting the pure functionality of the handle.







121 MR 022-31 - OC



121 RW 022 - OC



ART.						LV	OC OSC	
121 MR 022 - 31	Maniglia con rosetta Lever Handle on rose	022	Ø25 mm	con bocchetta with key rose		•	•	1
121 MR 022 - 32	Maniglia con rosetta Lever Handle on rose	022	Ø25 mm	con bocchetta with key rose		•	•	1
121 RW 022	Maniglia con rosetta Lever Handle on rose	022	Ø25 mm	con nottolino WC 503 with wc turn 503		•	•	1



429 MR 124-31 - OC



124 RO - OC





429 RQ 124 - OSC

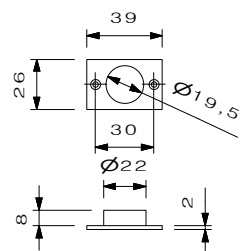
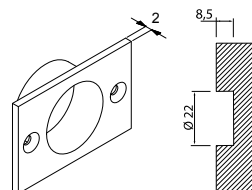

429 RW 124 - OSC



ART.					OC	OSC	
429 MR 124 - 31	Maniglia con rosetta Lever Handle on rose	124	mm 26 x 39	con bocchetta with key rose		•	1
429 MR 124 - 32	Maniglia con rosetta Lever Handle on rose	124	mm 26 x 39	con bocchetta with key rose		•	1
429 RW 124	Maniglia con rosetta Lever Handle on rose	124	mm 26 x 39	con nottolino WC 503 with wc turn 503		•	1
429 RQ 124	Maniglia con rosetta Lever Handle on rose	124	mm 26 x 39	con nottolino WC 124 with wc turn 124		•	1
124 RO			Rosetta mm 26 x 39 Rose mm 26 x 39			•	1





119 MR 022-31 - OC



119 RW 022 - OC



ART.						LV	OC OSC	
119 MR 022 - 31	Maniglia con rosetta Lever Handle on rose	022	Ø25 mm	con bocchetta with key rose		•	•	1
119 MR 022 - 32	Maniglia con rosetta Lever Handle on rose	022	Ø25 mm	con bocchetta with key rose		•	•	1
119 RW 022	Maniglia con rosetta Lever Handle on rose	022	Ø25 mm	con nottolino WC 503 with wc turn 503		•	•	1

art. **12** Q-ARTE



124 MR 124-31 - ZSC



425 Q-Insert - Ebano



425 Q-Insert - Wengè



426 B-Arte





124 RQ 124 - ZSC

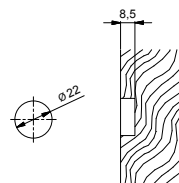

124 RO - OC



ART.					ZSC	SNV	
124 MR 124 - 31	Maniglia con rosetta <i>Lever Handle on rose</i>	124	mm 26 x 39	con bocchetta with key rose		•	1
124 MR 124 - 32	Maniglia con rosetta <i>Lever Handle on rose</i>	124	mm 26 x 39	con bocchetta with key rose		•	1
124 RQ 124	Maniglia con rosetta <i>Lever Handle on rose</i>	124	mm 26 x 39	con nottolino WC 503 with wc turn 503		•	1
124 RO	Rosetta mm 25 x 39 <i>Rose mm 25 x 39</i>				OC - OSC	SNV	
					•	•	

art.

NOTTOLINI WC

WC TURN AND RELEASE



Nott. per wc \varnothing 5,6,7 o 8
Wc turn and release with \varnothing 5,6,7 or 8

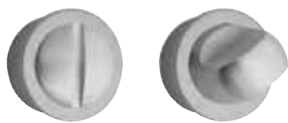

503 NO 022 OSC

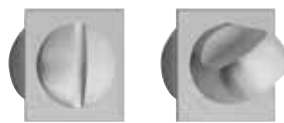

503 NO Q22 OSC

ART.				LV	OC OSC	SNV	
503 NO 022	Nottolino libero/occupato per wc con rosetta <i>Wc turn and release on rose</i>	022	\varnothing 25 mm	•	•	•	6
503 NO Q22	Nottolino libero/occupato per wc con rosetta <i>Wc turn and release on rose</i>	Q22	mm 25 x 25	•	•	•	6

ROSETTE E BOCCHETTE MINIMAL LINE

MINIMAL LINE ROSES AND ESCUTCHEONS



022 RO



022 BN

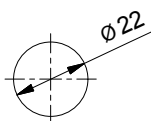

022 BY

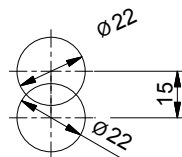

Q22 RO



Q22 BN

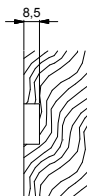

Q22 BY

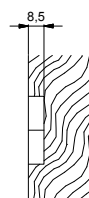

ART.		LV	OC OSC	SNV
022 RO	Rosetta MINIMAL tonda \varnothing 25 <i>MINIMAL round rose \varnothing25</i>	•	•	•
Q22 RO	Rosetta MINIMAL quadra mm 25 x 25 <i>MINIMAL square rose mm 25 x 25</i>	•	•	•
022 BN	Bocchetta MINIMAL tonda \varnothing 25 <i>MINIMAL round rose for key \varnothing25</i>	•	•	•
Q22 BN	Bocchetta MINIMAL quadra mm 25 x 25 <i>MINIMAL square rose for key mm 25 x 25</i>	•	•	•
022 BY	Bocchetta YALE MINIMAL ovale mm 25 x 40 <i>MINIMAL oval rose for euro profile cylinder hole (yale) mm 25 x 40</i>	•	•	•
Q22 BY	Bocchetta rettangolare YALE MINIMAL mm 25 x 40 <i>MINIMAL rectangular rose for euro profile cylinder (yale) mm 25 x 40</i>	•	•	•

Sistema MINIMAL LINE:
abbinabile, a richiesta, a TUTTE le maniglie del Catalogo Reguitti
MINIMAL LINE system:
suitable, on request, for all lever handles of Reguitti Catalogue

Extra Prezzo:
Extra Charge:

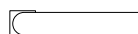
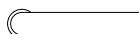

Maniglie con rosetta e
 bocchetta di serie
 005 - 006

Maniglie con rosetta e
 bocchetta
 MINIMAL TONDA 022

Maniglie con rosetta e
 bocchetta
 MINIMAL QUADRA Q22

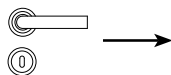

Maniglie con rosetta e
 bocchetta di serie
 Q08 - Q86

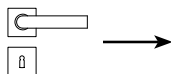

Maniglie con rosetta e
 bocchetta
 MINIMAL TONDA 022

Maniglie con rosetta e
 bocchetta
 MINIMAL QUADRA Q22

Finiture

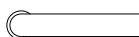

LV



OC
 OSC
 SNV



MINIMAL LINE

ISTRUZIONI DI MONTAGGIO ROSETTE A FILO / ASSEMBLING TEMPLATE

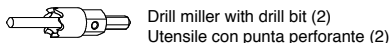
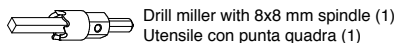
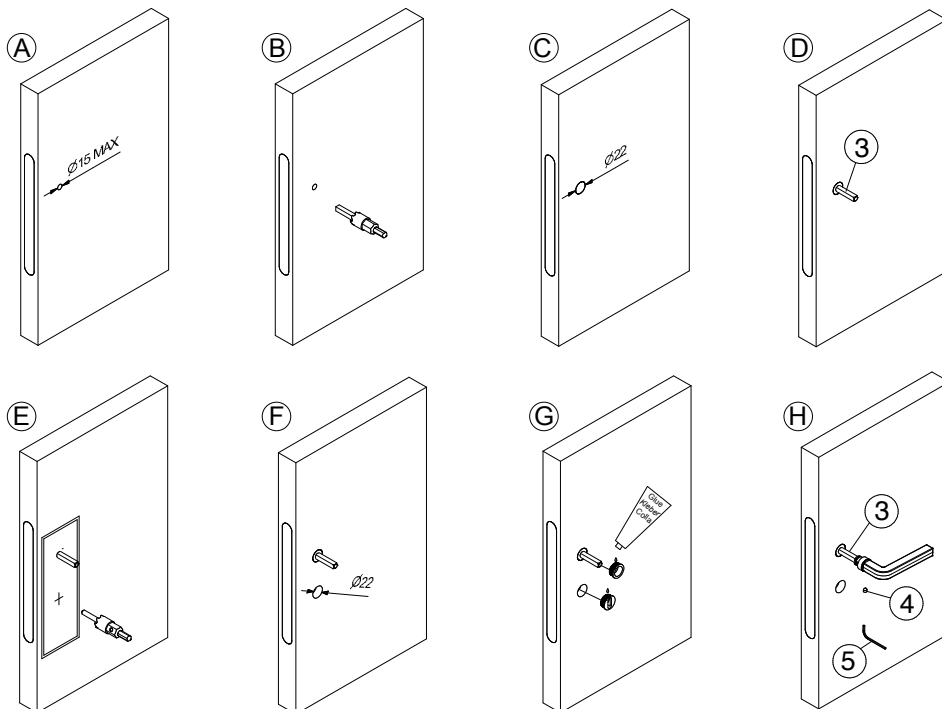

IT

ENG

A- Porta con serratura inserita.

B- Forare la porta assicurandosi che il foro Ø22 sia perfettamente in asse con il foro quadro della serratura. Consigliato l'utensile con montato punta quadra (1).

D- Inserire il ferro quadro 8 (3) in dotazione con la maniglia nel foro quadro della serratura.

E- Posizionare l'apposita dima infilandola sul ferro quadro fissandola parallela al filo porta con del nastro adesivo. Eseguire il foro Ø22 in centro al punto di riferimento indicato sulla dima. Consigliato l'utensile con punta perforante tonda (2).

G- Applicare della colla adeguata sui bordi delle rosette e bocchette ed inserirle negli appositi fori.

H- Assemblare le maniglie inserendole sul ferro quadro (3), serrare tenacemente il grano (4) con l'apposita chiave (5).

A- Door comprehensive of lock.

B- Drill the Ø22 mm door handle hole and make sure that it is perfectly aligned with the square hole of the lock. Recommended tool with 8x8 spindle mounted (1).

D- Insert the 8 mm (3) square spindle supplied with the door handle into the square lock hole.

E- Insert the template into the square spindle and fixing it parallel to the door with adhesive tape. Drill the Ø22 mm key escutcheon hole centering the reference point shown on the template. Recommended tool with drill bit mounted (2).

G- Apply proper glue on the edge of roses and key escutcheons and insert them into the done appropriate door holes.

H- Insert the lever handles in the square spindle (3). Tighten the grub screw (4) with the key supplied (5).

A RICHIESTA
On request

Utensile Di
foratura Ø 22 mm
completo di ferro Q8 e
punta tonda
Ø 22 mm Drill miller
with 8x8 spindle and
drill bit

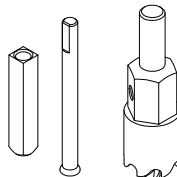

VF22FS0TQ

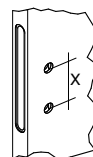

Interasse serratura
Lock center to center

		X
BN-BB 57	57	63,5
BN-BB 70	70	76,5
BN-BB 72	72	78,5
BN-BB 90	90	96,5
BY-PZ 47,5	47,5	47,5
BY-PZ 72	72	72
BY-PZ 85	85	85
BY-PZ 90	90	90
WC 57	57	57
WC 70	70	70
WC 78	78	78
WC 90	90	90

Info tecnica per nottolino wc - *Technical info for wc*

A richiesta tutte le maniglie su rosetta possono essere fornite con nottolino WC
On request every lever handle on rose can be supplied with wc turn

Esempio:
 Example:

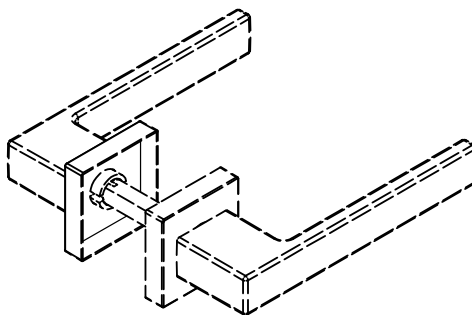

Maniglia con rosette e bocchette
 Handle with rose and rose for key
 124 MR Q86 - ZSC
 € 59,70

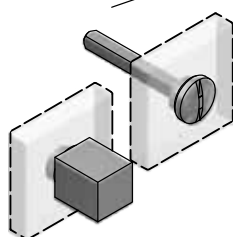
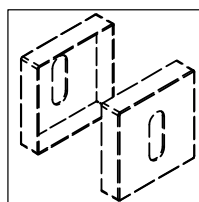

RQ

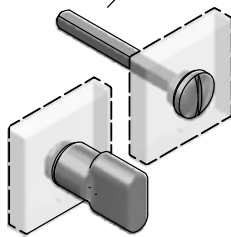

JR

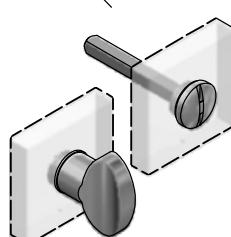

RG

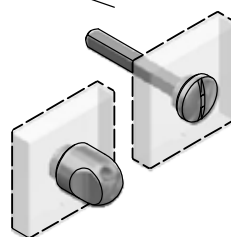

RW

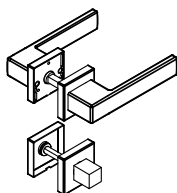

124 RQ Q86 - ZSC

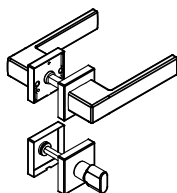

124 JR Q86 - ZSC

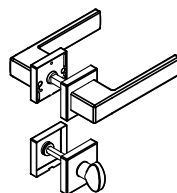

124 RG Q86 - ZSC

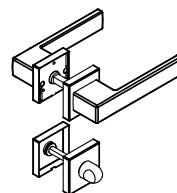

124 RW Q86 - ZSC

Info tecnica per nottolino wc - *Technical info for wc*

A richiesta tutte le maniglie con placca possono essere fornite con nottolino WC
On request every lever handle on plate can be supplied with wc turn

Esempio:
 Example:

Maniglia con placca e foro chiave
Handle with plate and key hole
 124 MP 130 - ZSC

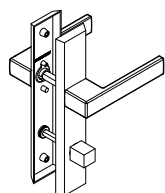
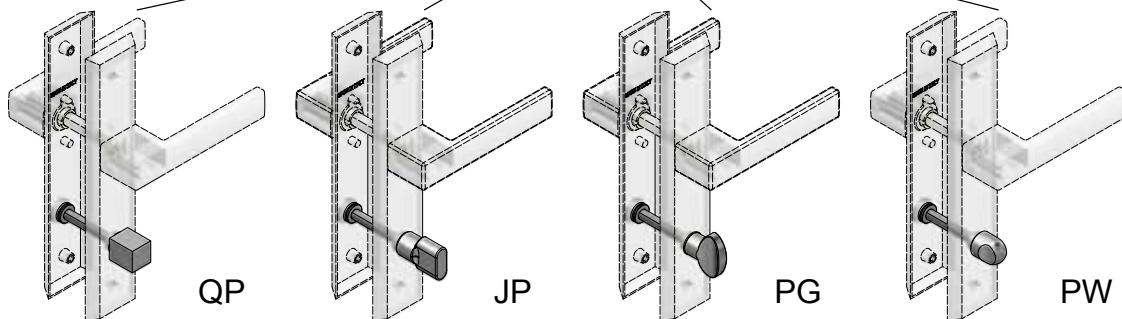
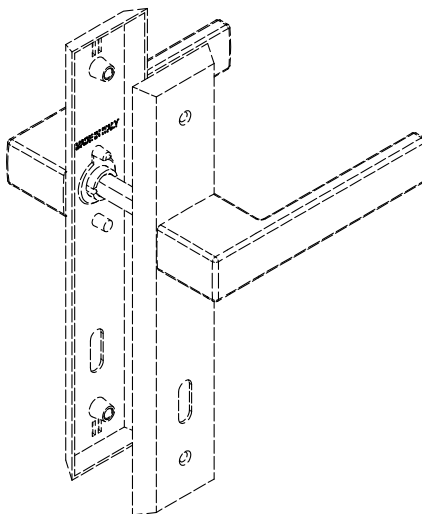

124 QP 130 - ZSC

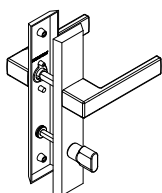

124 JP 130 - ZSC

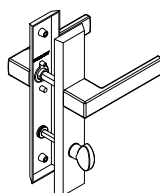

124 PG 130 - ZSC

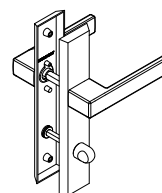

124 PW 130 - ZSC

Accessori per adattare serrature yale **all'applicazione del nottolino WC**
"Euro profile to WC Set" adaptation tools

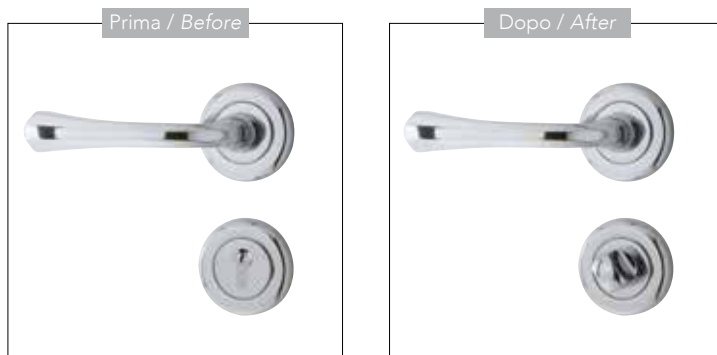

Soluzione senza sostituzione della serratura (applicabile solo a serrature yale)
"No lock replacement" solution (Euro profile locks only)

Cilindro di adattamento da foro yale a \varnothing 6mm per applicazione nottolino wc
 Adaptation cylinder for the replacement of the Euro profile metal cylinder with a \varnothing 6 mm hole, suitable for WC sets

Sostituire il cilindro yale in metallo
 Replace just the metal cylinder



006 CY €

Soluzione con sostituzione della serratura
 (applicabile a tutti i tipi di porte)
Lock replacement solution
 (applicable to all types of doors)

Serratura per WC \varnothing 8 con \varnothing 6 a distanza 90mm
 WC lock \varnothing 8 with \varnothing 6 c/c distance 90mm

Per le disponibilità delle entrate e delle finiture vedi pag. 965
 Please check (p. 965) for backsets and finishes availability



8SR

Maniglia con nottolino per wc WC door handle

Esempi di possibilità di **abbinamento** finiture diverse
Examples of different finishes **combinations**

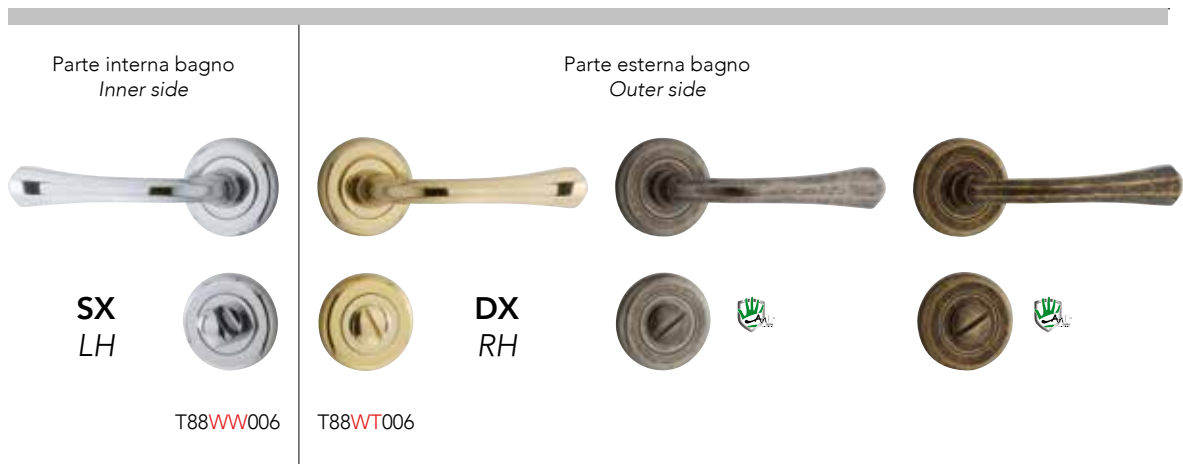

ESEMPI DI APPLICAZIONE
EXAMPLES OF APPLIANCE

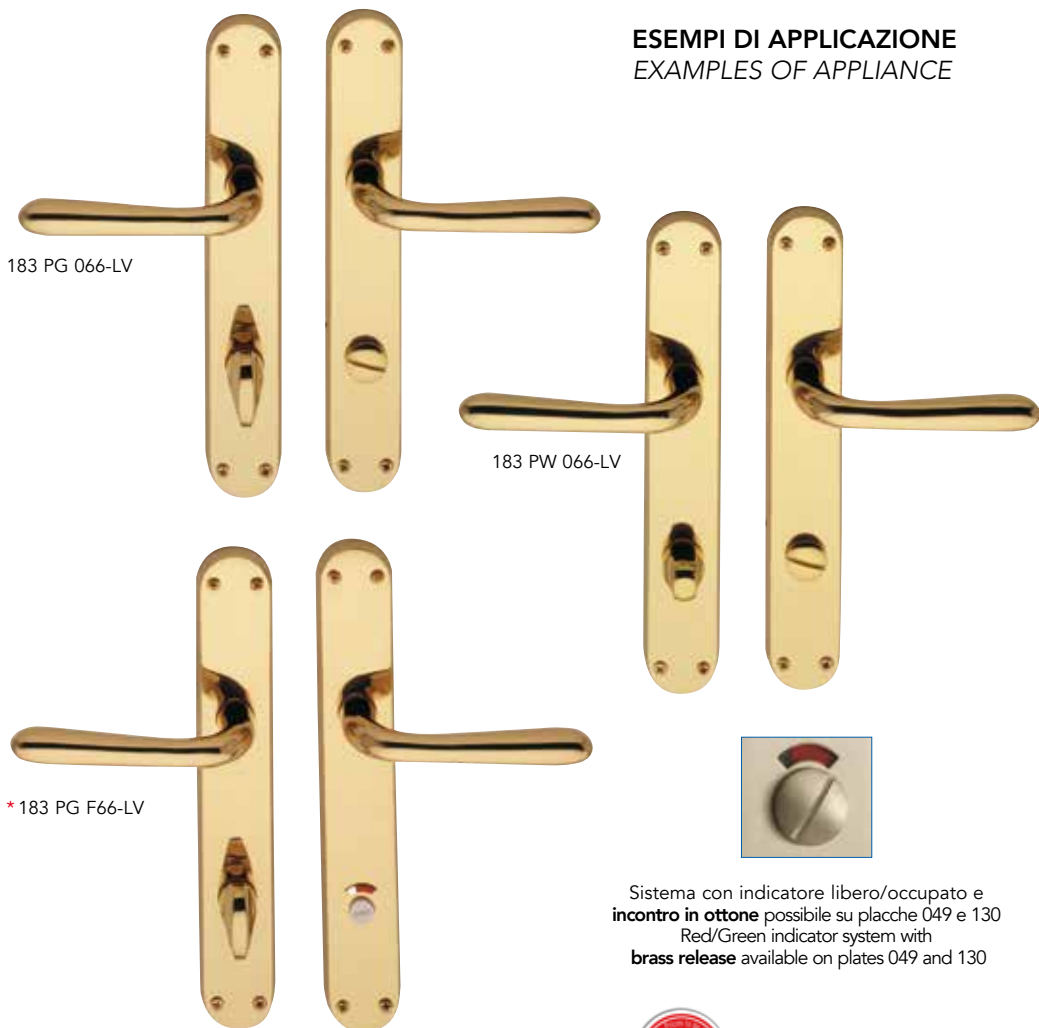

* sinistra/left

Sistema con indicatore libero/occupato e
incontro in ottone possibile su placche 049 e 130
Red/Green indicator system with
brass release available on plates 049 and 130



A RICHIESTA / ON REQUEST

TUTTE LE MANIGLIE SU PLACCA POSSONO ESSERE FORNITE CON NOTT. WC:
EXTRA SUL LISTINO DELLA MANIGLIA SCELTA

EXTRA PER FINITURA PVD

- N.B.** 1. SPECIFICARE DISTANZA E QUADRO DEL NOTTOLINO, Vedi TAB. C a pag. 31.
* 2. PER LE MANIGLIE SU PLACCA CON INDICATORE LIBERO/OCCUPATO (ES. ART.183PGF66) SPECIFICARE ANCHE SE IL NOTTOLINO DEVE ESSERE MONTATO A DESTRA O A SINISTRA.

EVERY LEVER **HANDLE ON PLATE** CAN BE SUPPLIED WITH WC TURN:**EXTRA PRICE**

EXTRA PRICE FOR PVD FINISH

- NOTES** 1. PLEASE SPECIFY SQUARE SPINDLE TURN AND DISTANCE, See TAB.C on pag. 31.
* 2. FOR LEVER HANDLE ON PLATE WITH INDICATOR (EX ART.183PGF66) PLEASE ALSO SPECIFY IF THE TURN WC HAVE TO BE MOUNTED ON THE LEFT OR RIGHT SIDE.

TIPO 503



TIPO 512



cod. "PW"

•

•

•

•

cod. "PG"

•

•

•

•

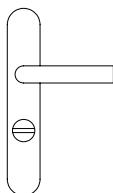

ESEMPI DI APPLICAZIONE EXAMPLES OF APPLIANCE

183 RG 006-LV



183 RW 006-LV



183 RG F06-LV



183 RW F06-LV



183 RW F04-LV



A RICHIESTA / ON REQUEST

TUTTE LE **MANIGLIE SU ROSETTA** POSSONO ESSERE FORNITE CON NOTT. WC:
EXTRA SUL LISTINO DELLA MANIGLIA SCELTA

EXTRA PER FINITURA PVD

N.B. SPECIFICARE QUADRO DEL NOTTOLINO (MM 5, 6, 7 o 8), vedi **TAB. D** a pag. 31.

EVERY LEVER **HANDLE ON ROSE** CAN BE SUPPLIED WITH WC TURN:**EXTRA PRICE**

EXTRA PRICE FOR PVD FINISH

NOTE PLEASE SPECIFY SQUARE SPINDLE TURN (MM 5, 6, 7 OR 8), see **TAB. D** on pag. 31.

TIPO 503



TIPO 512



cod. "RW"

•

•

•

•

cod. "RG"

•

•

•

•

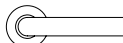

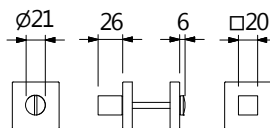

grano → 124 NO 000 - OSC



grano → 124 NO FQ8 - OSC



grano → 124 NO QN6 - OC



grano → 124 NO 4Q6 - OSC



grano → 124 NO Q05 - OSC



VERSIONI / VERSIONS

Finiture
Finishes

OC
OSC

SNV

PVD INOX



NIOTTOLINO WC / WC TURN AND RELEASE WHIT \varnothing 5 - 6 - 7 or 8

Model	Description	Code	Size	OC	OSC	SNV	PVD INOX	Box
124 NO 000	Nottolino libero/occupato per WC senza rosette WC turn and release without rose			•	•		•	6
124 NO 4Q6	Nottolino libero/occupato per WC con rosetta quadrata WC turn and release on square rose	4Q6	mm 45x45	•	•			6
124 NO Q05	Nottolino libero/occupato per WC con rosetta quadrata WC turn and release on square rose	Q05	mm 50x50	•	•			6
 124 NO QN6	Nottolino libero/occupato per WC con rosetta quadrata WC turn and release on square rose	QN6	mm 50x50	•	•		•	6
124 NO FQ8	Nottolino libero/occupato per WC con rosetta e indicatore WC turn and release on rose with indicator	FQ8	mm 50x50	•	•			6

Per caratteristiche tecniche rosette vedi apposito capitolo a pag. 865 / For technical specifications rosettes see specific section on page 865



J02 NO Q08 - OSC

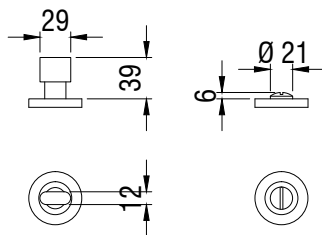

J02 NO FQ8 - OSC



J02 NO 006 - OC

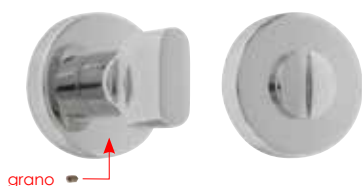

J02 NO 406 - OC

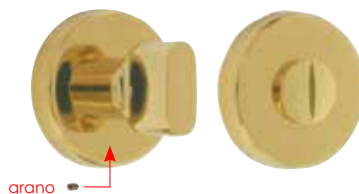

J02 NO 806 - LV



VERSIONI / VERSIONS

Finiture
Finishes

LV

OSC
OC

SNV



NIOTTOLINO WC / WC TURN AND RELEASE WITH \varnothing 5 - 6 - 7 or 8

			LV	OSC OC	SNV	
J02 NO 000	Nottolino libero/occupato per WC senza rosette <i>WC turn and release without rose</i>		•	•	•	6
J02 NO 006	Nottolino libero/occupato per WC con rosetta <i>WC turn and release on rose</i>	006 mm \varnothing 50x8	•	•	•	6
J02 NO 406	Nottolino libero/occupato per WC con rosetta <i>WC turn and release on rose</i>	406 mm \varnothing 45x9	•	•	•	6
J02 NO 806	Nottolino libero/occupato per WC con rosetta <i>WC turn and release on rose</i>	806 mm \varnothing 50x10	•	•	•	6
J02 NO FQ8	Nottolino libero/occupato per WC con rosetta e indicatore <i>WC turn and release on rose with indicator</i>	FQ8 mm 50x50		•	•	6
J02 NO Q05	Nottolino libero/occupato per WC con rosetta quadrata <i>WC turn and release on square rose</i>	Q05 mm 50x50		•	•	6
J02 NO Q08	Nottolino libero/occupato per WC con rosetta <i>WC turn and release on rose</i>	Q08 mm 50x50	•	•	•	6

Per caratteristiche tecniche rosette vedi apposito capitolo a pag. 865 / For technical specifications rosettes see specific section on page 865

art. 512 NO

512 NO 000-LV

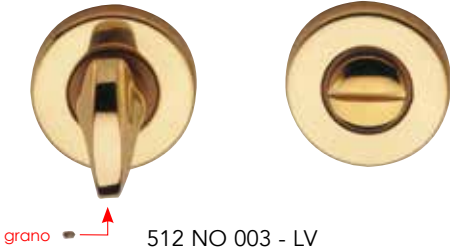
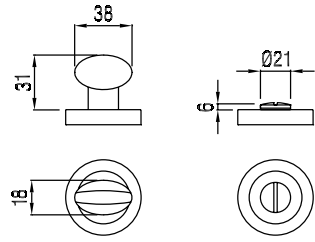
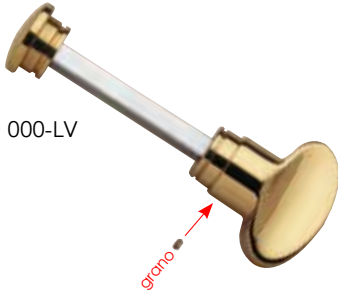

512 NO 003 - LV



512 NO 005 - OC



512 NO F05 - OC



512 NO 006 - OSC



512 NO F06 - LV



512 NO 008 - OSC



512 NO 406 - LV



512 NO 806 - OSC



512 NO 007 - OSC

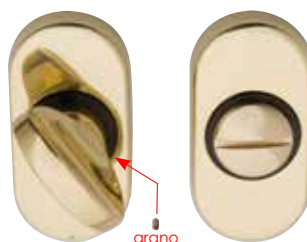

512 NO 009 - LV



512 NO FQ8 - OSC



512 NO Q08 - OSC



VERSIONI / VERSIONS

Finish
Finishes

LV
BG
OS

OC
OSC

OSC/OC
OC/LV



NIOTTOLINO WC / WC TURN AND RELEASE WITH \varnothing 5 - 6 - 7 or 8

Model	Description	Code	Size	LV	BG	OS	OC	OSC	OSC/OC	OC/LV	Price
512 NO 000	Nottolino libero/occupato per WC senza rosette WC turn and release without rose			•			•				6
512 NO 003	Nottolino libero/occupato per WC con rosetta WC turn and release on rose	003	mm \varnothing 45x7	•			•				6
512 NO 005	Nottolino libero/occupato per WC con rosetta WC turn and release on rose	005	mm \varnothing 50x8	•			•		•		6
512 NO 006	Nottolino libero/occupato per WC con rosetta WC turn and release on rose	006	mm \varnothing 50x8	•			•		•		6
512 NO 007	Nottolino libero/occupato per WC con rosetta WC turn and release on rose	007	mm 67x27	•			•				6
512 NO 008	Nottolino libero/occupato per WC con rosetta WC turn and release on rose	008	mm \varnothing 50x8	•			•				6
512 NO 009	Nottolino libero/occupato per WC con rosetta WC turn and release on rose	009	mm 62x32	•			•				6
512 NO 406	Nottolino libero/occupato per WC con rosetta WC turn and release on rose	406	mm \varnothing 45x9	•			•				6
512 NO 806	Nottolino libero/occupato per WC con rosetta WC turn and release on rose	806	mm \varnothing 50x10	•			•				6
512 NO F05	Nottolino libero/occupato per WC con rosetta e indicatore WC turn and release on rose with indicator	F05	mm \varnothing 50x8	•			•			•	6
512 NO F06	Nottolino libero/occupato per WC con rosetta e indicatore WC turn and release on rose with indicator	F06	mm \varnothing 50x8	•			•			•	6
512 NO F08	Nottolino libero/occupato per WC con rosetta e indicatore WC turn and release on rose with indicator	F08	mm 50x50	•			•				6
512 NO Q08	Nottolino libero/occupato per WC con rosetta WC turn and release on rose	Q08	mm 50x50	•			•				6

Per caratteristiche tecniche rosette vedi apposito capitolo a pag. 865 / For technical specifications rosettes see specific section on page 865

art. 503 NO



503 NO 000-LV

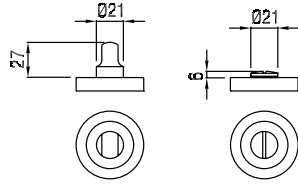

503 NO F03 - OC



503 NO 003 - OSC



503 NO F05 - OSC



503 NO 005 - LV



503 NO 006 - OSC



503 NO F06 - OC



503 NO 406 - LV



503 NO 806 - OC



503 NO 009 - OSC



503 NO 007 - LV



503 NO 008 - OSC



503 NO Q08 - OSC



503 NO F08 - OSC



503 NO FQ8 - OSC

VERSIONI / VERSIONS

Finiture Finishes LV BG OS OSC OC SNV PVD AGV AN 

NIOTTOLINO WC / WC TURN AND RELEASE WITH \varnothing 5 - 6 - 7 or 8

Model	Description	Code	Size	LV	BG	OS	OSC	OC	SNV	PVD	AGV	AN	Box
503 NO 000	Nottolino libero/occupato per WC senza rosette <i>WC turn and release without rose</i>			•			•		•	•	•	•	6
503 NO 003	Nottolino libero/occupato per WC con rosetta <i>WC turn and release on rose</i>	003	mm \varnothing 45x7	•			•			•	•	•	6
503 NO 005	Nottolino libero/occupato per WC con rosetta <i>WC turn and release on rose</i>	005	mm \varnothing 50x8	•			•						6
503 NO 006	Nottolino libero/occupato per WC con rosetta <i>WC turn and release on rose</i>	006	mm \varnothing 50x8	•			•			•	•	•	6
503 NO 007	Nottolino libero/occupato per WC con rosetta <i>WC turn and release on rose</i>	007	mm 67x27	•			•				•	•	6
503 NO 008	Nottolino libero/occupato per WC con rosetta <i>WC turn and release on rose</i>	008	mm \varnothing 50x8	•			•						6
503 NO 009	Nottolino libero/occupato per WC con rosetta <i>WC turn and release on rose</i>	009	mm 62x32	•			•					•	6
503 NO 406	Nottolino libero/occupato per WC con rosetta <i>WC turn and release on rose</i>	406	mm \varnothing 45x9	•			•			•	•	•	6
503 NO 4Q6	Nottolino libero/occupato per WC con rosetta quadrata <i>WC turn and release on square rose</i>	4Q6	mm 45x45				•		•				6
503 NO 806	Nottolino libero/occupato per WC con rosetta <i>WC turn and release on rose</i>	806	mm \varnothing 50x10	•			•					•	6
503 NO F03	Nottolino libero/occupato per WC con rosetta e indicatore <i>WC turn and release on rose with indicator</i>	F03	mm \varnothing 50x8	•			•				•	•	6
503 NO F05	Nottolino libero/occupato per WC con rosetta e indicatore <i>WC turn and release on rose with indicator</i>	F05	mm \varnothing 50x8	•			•						6
503 NO F06	Nottolino libero/occupato per WC con rosetta e indicatore <i>WC turn and release on rose with indicator</i>	F06	mm \varnothing 50x8	•			•						6
503 NO F08	Nottolino libero/occupato per WC con rosetta e indicatore <i>WC turn and release on rose with indicator</i>	F08	mm 50x50	•			•		•				6
503 NO FQ8	Nottolino libero/occupato per WC con rosetta e indicatore <i>WC turn and release on rose with indicator</i>	FQ8	mm 50x50				•		•				6
503 NO Q05	Nottolino libero/occupato per WC con rosetta quadrata <i>WC turn and release on square rose</i>	Q05	mm 50x50				•		•				6
503 NO Q08	Nottolino libero/occupato per WC con rosetta <i>WC turn and release on rose</i>	Q08	mm 50x50	•			•		•				6

Per caratteristiche tecniche rosette vedi apposito capitolo a pag. 865 / For technical specifications rosettes see specific section on page 865

CAPPUCCI COPRICERNIERE info tecniche

COVER HINGES - TECHNICAL INFO



PRIMA:
Cerniera anuba in ferro
Before:
Anuba hinge



MONTAGGIO CAPPUCCI
Hinge Covers Mounting



DOPO:
Con cappucci "Reguitti"
After:
Hinge covers mounted

MISURE CERNIERA HINGE SIZE

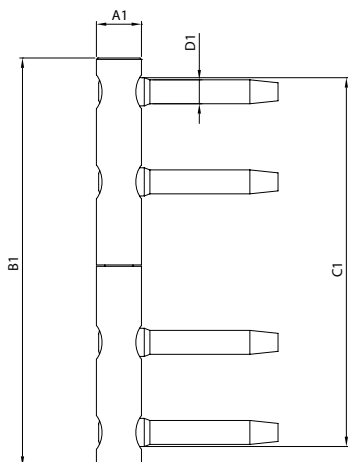

MISURE CAPPUCCIO HINGE COVER SIZE

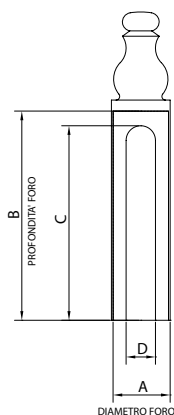

Individuazione dell'articolo adatto:



- Il diametro A deve essere uguale al diametro A1.
- La profondità foro Bx2 deve essere uguale o superiore alla misura B1.
- La lunghezza Cx2 deve essere uguale o superiore alla lunghezza C1.
- La larghezza D deve essere uguale o superiore al diametro D1.

COMPATIBILITÀ DEI CAPPUCCI REGUITTI CON ALCUNE CERNIERE ANUBA

TECHNICAL INFO FOR REGUITTI COVER HINGES COMPATIBILITY WITH ANUBA HINGES

* SOLO A RICHIESTA PER QUANTITÀ DA DEFINIRE

* ON REQUEST ONLY AND FOR QUANTITY TO BE FINALIZED

 PEZZI NECESSARI PER OGNI CERNIERA
 COVERS REQUESTED FOR EACH HINGE



COSTRUTTORE CERNIERE HINGES MANUFACTURER	TIPO CERNIERA TYPE OF HINGE	Ø CERNIERA HINGE Ø	PZ. 	COPRIANUBA REGUITTI COMPATIBILI REGUITTI COMPATIBLE HINGES COVERS			
				821AN014	829AN014	A21AN014	A25AN014
AGB	3D REGISTRABILE	14	2	821AN014	829AN014	A21AN014	A25AN014
AGB	3D REGISTRABILE	16	2	821AN016	829AN016	A21AN016	A25AN016
AGB	119	13	2	820AN013	828AN013		A24AN013
AGB	119	14	2	820AN014	828AN014		A24AN014 824AN014
AGB	119	16	2	820AN016	828AN016		
AGB	ZENIT REGISTRABILE	16	2	821ANG16	829ANG16		
AGB	ZENIT REGISTRABILE	20	2	821ANG20	829ANG20		
AGB	TOP REGISTRABILE	16	1	821AN016	829AN016		
			1	821AN916	829AN916		
AGB	TOP REGISTRABILE	20	1	821AN020	829AN020		
			1	821ANG20	829ANG20		
AGB	REVER	14	2	820ANG14*	828ANG14*		
OTLAV	055130A	13	2	820AN013	828AN013		A24AN013
OTLAV	055140A	14	2	820AN014	828AN014		A24AN014 824AN014
OTLAV	055160A	16	2	820AN016	828AN016		
OTLAV	495140 REGISTRABILE	14	2	821AN014	829AN014	A21AN014	A25AN014
OTLAV	495160 REGISTRABILE	16	2	821AN016	829AN016	A21AN016	A25AN016
OTLAV	495200A REGISTRABILE	20	2	821AN020	829AN020		
OTLAV	URSUS	16	1	821AN016	829AN016		
			1	821AN916	829AN916		
OTLAV	URSUS	18	1	821ANU18 821ANG18	829ANU18 829ANG18		
OTLAV	EXACTA 2 REGISTRA- BILE	14	2	820AN014	828AN014		
SFS INTEC	11R-14-000	14	2	821AN014	829AN014	A21AN014	A25AN014
SFS INTEC	20-14-000	14	2	820AN014	828AN014		A24AN014 824AN014
SFS INTEC	11R-15-000 "TIPO CORTO" 92 MM	15	2	821ANT15*	829ANT15		
SFS INTEC	11R-15-003 "TIPO LUNGO" 112 MM	15	2	821AN015	829AN015		
SFS INTEC	11R-20 "TIPO LUNGO" 112 MM	20	2	821AN020	829AN020		
LAFLORIDA	182R L1	14	2	821AN014	829AN014	A21AN014	A25AN014
LAFLORIDA	182R N1	16	2	821AN016	829AN016	A21AN016	A25AN016
LAFLORIDA	182R R	20	2	821AN020	829AN020		

COMPATIBILITÀ DEI CAPPUCCI REGUITTI CON ALCUNE CERNIERE ANUBA

TECHNICAL INFO FOR REGUITTI COVER HINGES COMPATIBILITY WITH ANUBA HINGES



COSTRUTTORE CERNIERE HINGES MANUFACTURER	TIPO CERNIERA TYPE OF HINGE	Ø CERNIERA HINGE Ø	PZ. ◎	COPRIANUBA REGUITTI COMPATIBILI REGUITTI COMPATIBLE HINGES COVERS	
SIMONSWERK	V3420 WF	15	2	821ANG15	829ANG15
SIMONSWERK	V4200 WF	15	1	821ANG15	829ANG15
SIMONSWERK	V4400 VF	15	1	821ANG15	829ANG15
SIMONSWERK	V4700 WF	15	1	821ANG15	829ANG15
SIMONSWERK	V3200 WF	15	1	821AN915	829AN915
SIMONSWERK	V3400 WF	15	1	821AN915	829AN915
SIMONSWERK	V0020	15	1	821ANS15	829ANS15



COSTRUTTORE CERNIERE HINGES MANUFACTURER	TIPO CERNIERA TYPE OF HINGE	Ø CERNIERA HINGE Ø	PZ. ◎	COPRIANUBA REGUITTI COMPATIBILI REGUITTI COMPATIBLE HINGES COVERS	
SIMONSWERK	V4426 WF	15	2	821ANS15	829ANS15
			1	820ANL15	820ANL15
SIMONSWERK	C1-15 WF	15	2	820AN015	828AN015
			1	820ANC15	820ANC15
SIMONSWERK	C2-15 WF	15	2	820AN015	828AN015
			1	820ANC15	820ANC15
SIMONSWERK	V4226 WF	15	2	820ANB15	828ANB15
			1	820ANL15	820ANL15

CERNIERA SIMMETRICA
Symmetrical Hinge

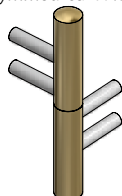

2 cappucci stessa lunghezza
2 Same length Hinges covers

CERNIERA ASIMMETRICA
Asymmetrical Hinge

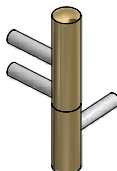

1 cappuccio lungo 1 cappuccio corto
1 Hinge cover shorter and
1 Hinge cover longer

CERNIERA TRE PEZZI
Hinge made of three pieces

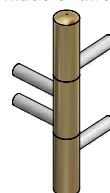

2 cappucci standard + 1 cappuccio centrale
2 standard Hinges covers and 1 cover central Hinge



	A	B	C	D
820 AN 013	13	35	11	7
820 AN 014	14	30	12	8
820 AN G14	14	28	22	8
820 AN 015	15	20	14	8
820 AN B15	15	31	15	8
820 AN 016	16	28	12	8

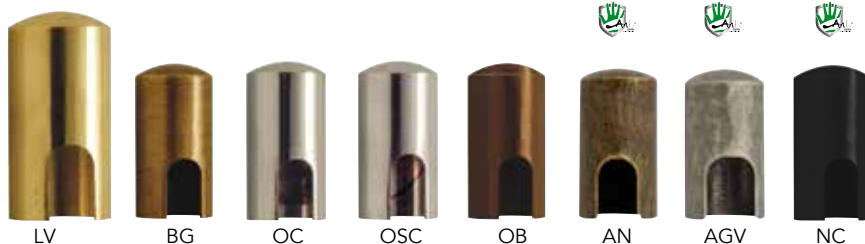

LV

BG

OC

OSC

OB

AN

AGV

NC

ø13 sono fino a esaurimento

		LV	OB	BG OS	OC OSC	AN	VBN	AGV	RX	
CAPPUCCIO IN OTTONE PER CERNIERE ANUBA / BRASS HINGE-COVER										
820 AN 013	Cappuccio art.820 per cerniere anuba ø13 <i>Hinge-Cover art.820 ø13</i>	•	•	•	•	•	•	•	•	24
820 AN 014	Cappuccio art.820 per cerniere anuba ø14 <i>Hinge-Cover art.820 ø14</i>	•	•	•	•	•	•	•	•	24
820 AN G14*	Cappuccio art.820 per cerniere anuba ø14 <i>Hinge-Cover art.820 ø14</i>	-	-	-	-	-	-	-	-	24
820 AN 015	Cappuccio art.820 per cerniere anuba ø15 <i>Hinge-Cover art.820 ø15</i>	•	•	•	•	•	•	•	•	24
820 AN B15	Cappuccio art.820 per cerniere anuba ø15 <i>Hinge-Cover art.820 ø15</i>	•	•	•	•	•	•	•	•	24
820 AN 016	Cappuccio art.820 per cerniere anuba ø16 <i>Hinge-Cover art.820 ø16</i>	•	•	•	•	•	•	•	•	24

* solo a richiesta e per quantità da definire
on request only and for quantity to be finalized

820 AN C15
LV

820 AN L15 LV

	D	A	H
820 AN C15	8	15	42
820 AN L15	8	15	48

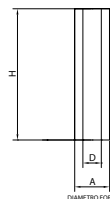

		LV	OC OSC	AN	VBN	NC AGV	
CAPPUCCIO CENTRALE IN OTTONE PER CERNIERE ANUBA / CENTRAL BRASS HINGE-COVER							
820 AN C15	Cappuccio art.820 per cerniere anuba ø15 <i>Hinge-Cover art.820 ø15</i>	•	•	•	•	•	24
820 AN L15	Cappuccio art.820 per cerniere anuba ø15 <i>Hinge-Cover art.820 ø15</i>	•	•	•	•	•	24

art. 821 AN

OTTONE / BRASS

	A	B	C	D
821 AN 014	14	50	42	9
821 AN 015	15	57	53	8
821 AN 915*	15	41	38	8
821 AN G15*	15	53	38	8
821 AN S15*	15	40	24	8
821 AN T15*	15	50	46	8
821 AN 016	16	50	40	8
821 AN 916*	16	63	62	8,5
821 AN G16	16	74	67	9,5
821 AN U18*	18	55	52	10
821 AN G18*	18	90	88	10
821 AN 020	20	60	55	9,5
821 AN G20*	20	76	69	9,5

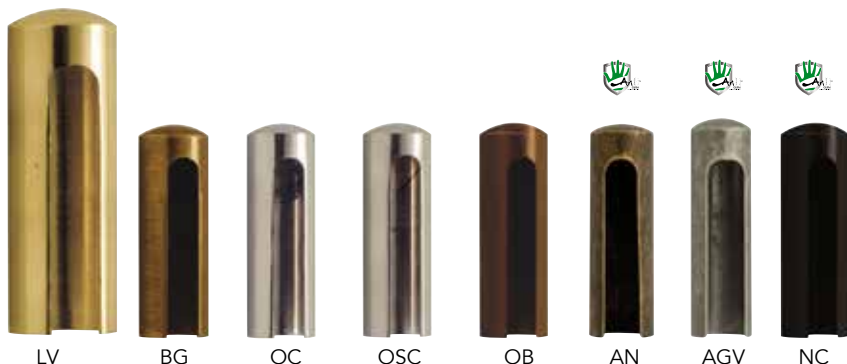
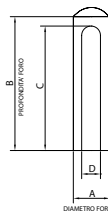

LV

BG

OC

OSC

OB

AN

AGV

NC

		LV	OB	BG OS	OC OSC	AN	VBN	NC AGV	RX	
CAPPuccio IN OTTONE PER CERNIERE ANUBA REGISTRABILI / ADJUSTABLE BRASS HINGE-COVER										
821 AN 014	Cappuccio art.821 per cerniere anuba registrabili ø14 Adjustable Hinge-Cover art.821 ø14	•	•	•	•	•	•	•	•	24
821 AN 015	Cappuccio art.821 per cerniere anuba registrabili ø15 Adjustable Hinge-Cover art.821 ø15	•	•	•	•	•	•	•	•	24
821 AN 915	Cappuccio art.821 per cerniere anuba registrabili ø15 Adjustable Hinge-Cover art.821 ø15	•	-	-	•	•	•	•	-	24
821 AN G15	Cappuccio art.821 per cerniere anuba registrabili ø15 Adjustable Hinge-Cover art.821 ø15	•	-	-	•	•	•	•	-	24
821 AN S15	Cappuccio art.821 per cerniere anuba registrabili ø15 Adjustable Hinge-Cover art.821 ø15	•	-	-	•	•	•	•	-	24
821 AN T15*	Cappuccio art.821 per cerniere anuba registrabili ø15 Adjustable Hinge-Cover art.821 ø15	•	•	•	•	•	•	•	•	24
821 AN 016	Cappuccio art.821 per cerniere anuba registrabili ø16 Adjustable Hinge-Cover art.821 ø16	•	•	•	•	•	•	•	•	24
821 AN 916	Cappuccio art.821 per cerniere anuba registrabili ø16 Adjustable Hinge-Cover art.821 ø16	•	•	•	•	•	•	•	•	24
821 AN G16	Cappuccio art.821 per cerniere anuba registrabili ø16 Adjustable Hinge-Cover art.821 ø16	•	•	•	•	•	•	•	•	24
821 AN U18	Cappuccio art.821 per cerniere anuba registrabili ø18 Adjustable Hinge-Cover art.821 ø18	•	-	•	•	•	•	•	-	24
821 AN G18	Cappuccio art.821 per cerniere anuba registrabili ø18 Adjustable Hinge-Cover art.821 ø18	•	-	•	•	•	•	•	-	24
821 AN 020	Cappuccio art.821 per cerniere anuba registrabili ø20 Adjustable Hinge-Cover art.821 ø20	•	•	•	•	•	•	•	•	24
821 AN G20	Cappuccio art.821 per cerniere anuba registrabili ø20 Adjustable Hinge-Cover art.821 ø20	•	•	•	•	•	•	•	•	24

* solo a richiesta e per quantità da definire
on request only and for quantity to be finalized

art. 828 AN

OTTONE / BRASS



	A	B	C	D
828 AN 013	13	26,5	11	7
828 AN 014	14	26,5	12	8
828 AN G14	14	28	22	8
828 AN B15*	15	31	15	8
828 AN 016	16	28	12	8
828 AN 015*	15	20	14	8

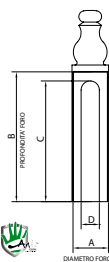

AGV



AN



BG



LV



OB



VBN



RX



NC

		LV	BG OS	OC OSC	AN	VBN	NC AGV	RX	
CAPPuccio IN OTTONE PER CERNIERE ANUBA / BRASS HINGE-COVER									
828 AN 013	Cappuccio art.828 per cerniere anuba ø13 <i>Hinge-Cover art.828 ø13</i>	•	•	•	•	•	•	•	24
828 AN 014	Cappuccio art.828 per cerniere anuba ø14 <i>Hinge-Cover art.828 ø14</i>	•	•	•	•	•	•	•	24
828 AN G14*	Cappuccio art.828 per cerniere anuba ø14 <i>Adjustable Hinge-Cover art.828 ø14</i>	•	•	•	•	•	•	•	24
828 AN 015	Cappuccio art.828 per cerniere anuba ø15 <i>Adjustable Hinge-Cover art.828 ø15</i>	•	-	•	•	•	•	-	24
828 AN B15	Cappuccio art.828 per cerniere anuba ø15 <i>Adjustable Hinge-Cover art.828 ø15</i>	•	-	•	•	•	•	-	24
828 AN 016	Cappuccio art.828 per cerniere anuba ø16 <i>Hinge-Cover art.828 ø16</i>	•	•	•	•	•	•	•	24

* solo a richiesta e per quantità da definire
on request only and for quantity to be finalized

art. 839 AN

OTTONE / BRASS

	A	B	C	D
839 AN 013	13	48	47	4
839 AN 014	14	48	47	4

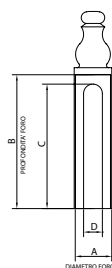

AN



AGV



LV

		LV	BG	OC OSC	AN	AGV	RX	
CAPPuccio IN OTTONE PER CERNIERE PER PROFILI ALLUMINIO / BRASS HINGE-COVER								
839 AN 013	Cappuccio art.839 per cerniere anuba ø13 <i>Hinge-Cover art.839 ø13</i>	•	•	•	•	•	•	24
839 AN 014	Cappuccio art.839 per cerniere anuba ø14 <i>Hinge-Cover art.839 ø14</i>	•	•	•	•	•	•	24

OTTONE / BRASS

	A	B	C	D
829 AN 014	14	50	42	9
829 AN 015	15	57	53	8
829 AN 915*	15	41	38	8
829 AN G15*	15	53	38	8
829 AN S15*	15	40	24	8
829 AN T15*	15	50	46	8
829 AN 016	16	50	40	8
829 AN Z16*	16	43	40	8
829 AN 916*	16	63	62	8,5
829 AN G16	16	74	67	9,5
829 AN U18*	18	55	52	10
829 AN G18*	18	90	88	10
829 AN 020	20	60	55	9,5
829 AN G20	20	76	69	9,5

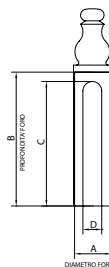

LV



AN



VBN



AGV



RX



BG



OSC



NC

		LV	BG OS	OC OSC	AN	VBN	NC AGV	RX	
CAPPUCCIO IN OTTONE PER CERNIERE ANUBA REGISTRABILI / ADJUSTABLE BRASS HINGE-COVER									
829 AN 014	Cappuccio art.829 per cerniere anuba registrabili ø14 <i>Adjustable Hinge-Cover art.829 ø14</i>	•	•	•	•	•	•	•	24
829 AN 015	Cappuccio art.829 per cerniere anuba registrabili ø15 <i>Adjustable Hinge-Cover art.829 ø15</i>	•	•	•	•	•	•	•	24
829 AN 915	Cappuccio art.829 per cerniere anuba registrabili ø15 <i>Adjustable Hinge-Cover art.829 ø15</i>	•	-	•	•	•	•	-	24
829 AN G15	Cappuccio art.829 per cerniere anuba registrabili ø15 <i>Adjustable Hinge-Cover art.829 ø15</i>	•	-	•	•	•	•	-	24
829 AN S15	Cappuccio art.829 per cerniere anuba registrabili ø15 <i>Adjustable Hinge-Cover art.829 ø15</i>	•	-	•	•	•	•	-	24
829 AN T15	Cappuccio art.829 per cerniere anuba registrabili ø15 <i>Adjustable Hinge-Cover art.829 ø15</i>	•	•	•	•	•	•	•	24
829 AN 016	Cappuccio art.829 per cerniere anuba registrabili ø16 <i>Adjustable Hinge-Cover art.829 ø16</i>	•	•	•	•	•	•	•	24
829 AN Z16*	Cappuccio art.829 per cerniere anuba registrabili ø16 <i>Adjustable Hinge-Cover art.829 ø16</i>	•	•	•	•	•	•	•	24
829 AN 916	Cappuccio art.829 per cerniere anuba registrabili ø16 <i>Adjustable Hinge-Cover art.829 ø16</i>	•	•	•	•	•	•	•	24
829 AN G16	Cappuccio art.829 per cerniere anuba registrabili ø16 <i>Adjustable Hinge-Cover art.829 ø16</i>	•	•	•	•	•	•	•	24
829 AN U18	Cappuccio art.829 per cerniere anuba registrabili ø18 <i>Adjustable Hinge-Cover art.829 ø18</i>	•	•	•	•	•	•	•	24
829 AN G18	Cappuccio art.829 per cerniere anuba registrabili ø18 <i>Adjustable Hinge-Cover art.829 ø18</i>	•	•	•	•	•	•	•	24
829 AN 020	Cappuccio art.829 per cerniere anuba registrabili ø20 <i>Adjustable Hinge-Cover art.829 ø 20</i>	•	•	•	•	•	•	•	24
829 AN G20	Cappuccio art.829 per cerniere anuba registrabili ø20 <i>Adjustable Hinge-Cover art.829 ø 20</i>	•	•	•	•	•	•	•	24

* solo a richiesta e per quantità da definire
on request only and for quantity to be finalized

art. A21 AN





ALLUMINIO / ALUMINIUM

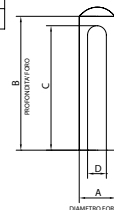

OTTONATO CROMATO CROMATO OPACO BRONZO

	A	B	C	D
A21 AN 014	14	44	42	8
A21 AN 016	16	45	42	9



		OTTONATO	CROMATO	CROMATO OPACO	BRONZO	
CAPPUCCIO IN ALLUMINIO PER CERNIERE ANUBA REGISTRABILI / ADJUSTABLE ALUMINIUM HINGE-COVER						
A21 AN 014	Cappuccio art.A21 per cerniere anuba $\phi 14$ <i>Hinge-Cover art.A21 $\phi 14$</i>	•	•	•	•	50
A21 AN 016	Cappuccio art.A21 per cerniere anuba $\phi 16$ <i>Hinge-Cover art.A21 $\phi 16$</i>	•	•	•	•	50

art. A24 AN

ALLUMINIO / ALUMINIUM



OTTONATO CROMATO CROMATO OPACO

	A	B	C	D
A24 AN 013	13	30	12	7
A24 AN 014	14	30	12	8

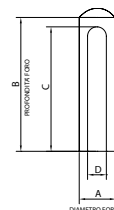

		OTTONATO	CROMATO	CROMATO OPACO	BRONZO	
CAPPUCCIO IN ALLUMINIO PER CERNIERE ANUBA / ALUMINIUM HINGE-COVER						
A24 AN 013	Cappuccio art.A24 per cerniere anuba $\phi 13$ <i>Hinge-Cover art.A24 $\phi 13$</i>	•	•	•	•	100
A24 AN 014	Cappuccio art.A24 per cerniere anuba $\phi 14$ <i>Hinge-Cover art.A24 $\phi 14$</i>	•	•	•	•	100

art. A25 AN



ALLUMINIO / ALUMINIUM



OTTONATO



CROMATO



CROMATO
OPACO

	A	B	C	D
A25 AN 014	14	44	42	8
A25 AN 016	16	43	43	9

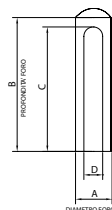

		OTTONATO	CROMATO	CROMATO OPACO	BRONZO	
CAPPUCCIO IN ALLUMINIO PER CERNIERE ANUBA REGISTRABILI / ADJUSTABLE ALUMINIUM HINGE-COVER						
A25 AN 014	Cappuccio art.A25 per cerniere anuba $\varnothing 14$ <i>Hinge-Cover art.A25 $\varnothing 14$</i>	•	•	•	•	100
A25 AN 016	Cappuccio art.A25 per cerniere anuba $\varnothing 16$ <i>Hinge-Cover art.A25 $\varnothing 16$</i>	•	•	•	•	100

art. 831 AN

OTTONE / BRASS



OTTONATO



esempi di applicazione

	A	B	C	D
831 AN 013	13	48	47	4
831 AN 014	14	48	47	4

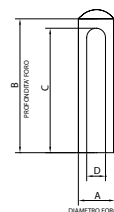

		LV	OB BG	OC OSC	AN	NC AGV	VBN	
CAPPUCCIO IN OTTONE PER CERNIERE PER PROFILI ALLUMINIO / BRASS HINGE-COVER								
831 AN 013	Cappuccio art.831 per cerniere anuba $\varnothing 13$ <i>Hinge-Cover art.831 $\varnothing 13$</i>	•	•	•	•	•	•	24
831 AN 014	Cappuccio art.831 per cerniere anuba $\varnothing 14$ <i>Hinge-Cover art.831 $\varnothing 14$</i>	•	•	•	•	•	•	24

Placche per ristrutturazioni Plates for renovations



Placche speciali per ristrutturazione con dimensioni maggiorate per coprire impronte preesistenti

Plates for substitution with oversized dimensions to cover preexisting signs

■ Per porte - For doors



Maniglia obsoleta
Door handle obsolete



Dopo lo smontaggio
After disassembly



Nuova maniglia
New door handle

265 KP PER PORTE

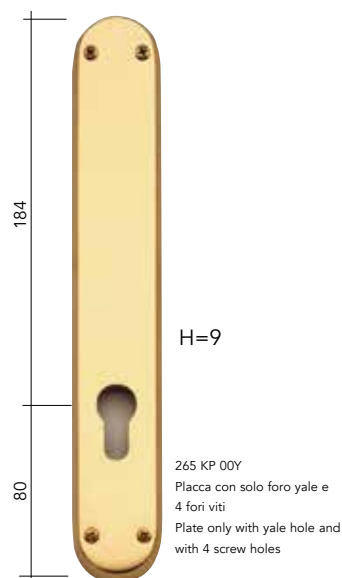
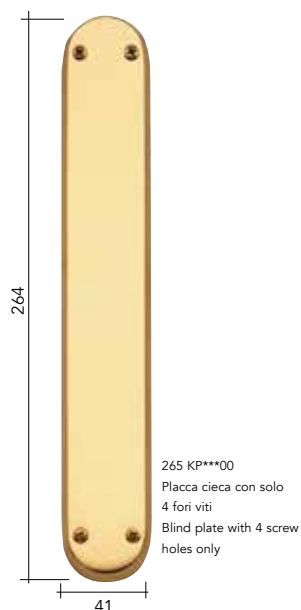
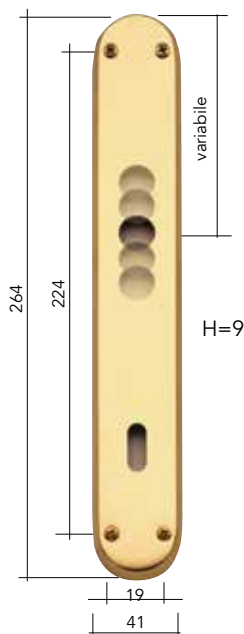



Versione Aggiornata - Updated Version

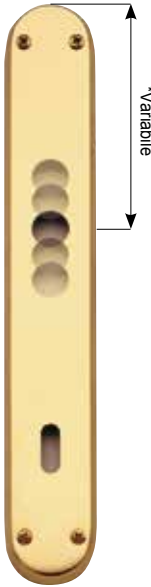

*Con molla in qualsiasi posizione
Posizione standard, se non diversamente specificato,
mm 106

*With returning spring in any position
Standard position, if not specified, 106 mm

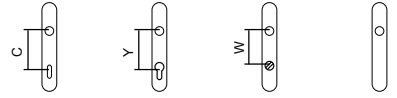

PLACCA PER MANIGLIA / PLATE FOR LEVER HANDLE	C	Y	W	
	70	70	70	•
	72	72	72	
	75	85	78	
	90	88	85	
		90	90	
		92	96	

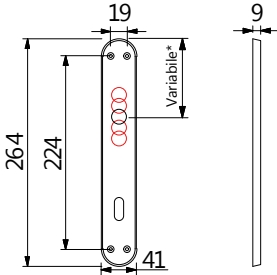

SISTEMA DI MONTAGGIO STANDARD
STANDARD MOUNTING SYSTEM



Adattabile ad ogni impugnatura / Suitable for every lever handles

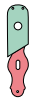

Versione Aggiornata - Updated Version

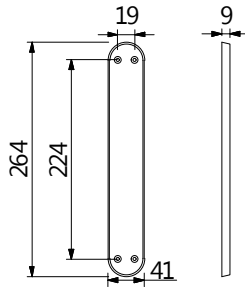
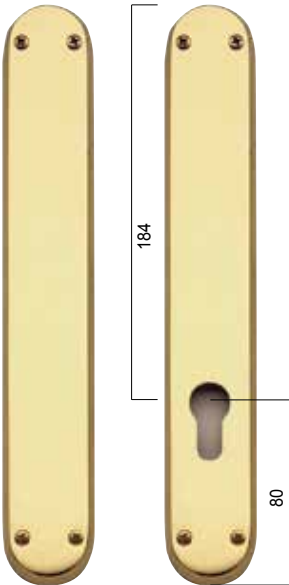

SISTEMA DI MONTAGGIO STANDARD
STANDARD MOUNTING SYSTEM



Finiture
Finishes

LV
BG

OC
OSC



		€	€
265 KP ***00	Placca cieca con solo 4 fori viti Blind plate with 4 screw holes only	•	•
265 KP 00Y	Placca con solo foro yale e 4 fori viti Plate only with yale hole and with 4 screw holes	•	•

265 KP *** 00 - LV 265 KP 00Y - LV

art. Q65 KP



PLACCA SPECIALE PER SOSTITUZIONE
SPECIAL PLATE FOR SUBSTITUTION

*Con molla in qualsiasi posizione
 Posizione standard, se non diversamente specificato,
 mm 106

*With returning spring in any position
 Standard position, if not specified, 106 mm



PLACCA PER MANIGLIA / PLATE FOR LEVER HANDLE

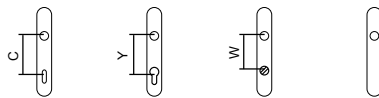

C	Y	W	
70	70	70	•
72	72	72	
75	85	78	
90	88	85	
	90	90	
	92	96	

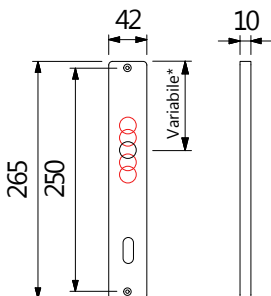

SISTEMA DI MONTAGGIO STANDARD
 STANDARD MOUNTING SYSTEM



Solo a richiesta, prezzi e quantità da definire
 On request only, and for quantity to be finalized

Adattabile ad ogni impugnatura
 Suitable for every lever handles

art. Q65 KP

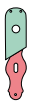

PLACCA SPECIALE PER SOSTITUZIONE
SPECIAL PLATE FOR SUBSTITUTION

Versione Aggiornata - Updated Version

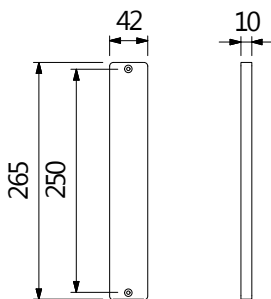
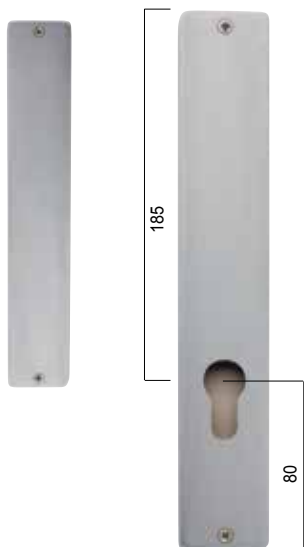

SISTEMA DI MONTAGGIO STANDARD
 STANDARD MOUNTING SYSTEM



Solo a richiesta, prezzi e quantità da definire
 On request only, and for quantity to be finalized

Q65 KP *** - OSC Q65 KP 00Y - OSC

SPECIALI PER PROFILI STRETTI - FOR SPECIAL NARROW PROFILES
PER PORTE - FOR DOORS



B76 -COLLO EXTRA BASSO

IMPUGNATURA PER MANIGLIA / LEVER HANDLE

		LV BG	OSC OC
B76 IP	Solo impugnatura c/ferro q.8x120, fisso-spinato	•	•
B76 MR 007	Maniglia con collo ribassato con rosetta 007 mm 68x28 ovale stretta con grano	•	•
B76 DK 015	Dreh Kipp con collo ribassato con rosetta 015 mm 65x31 con movimento in metallo	•	•

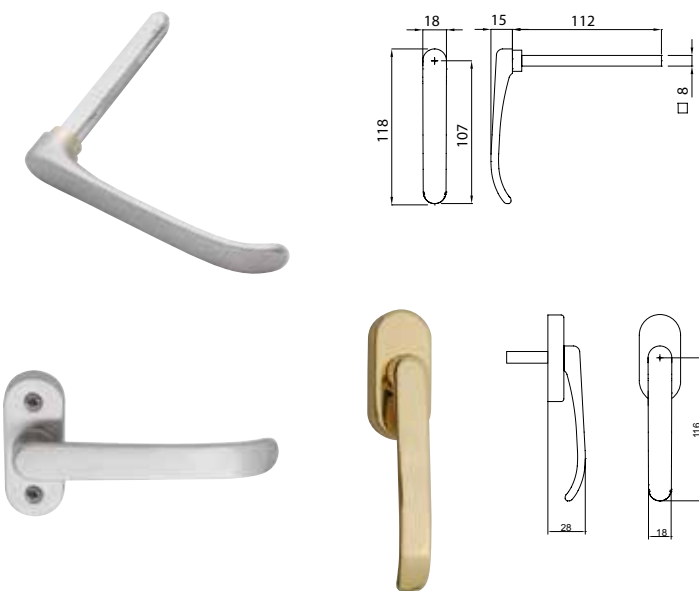
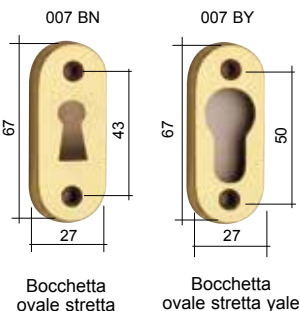
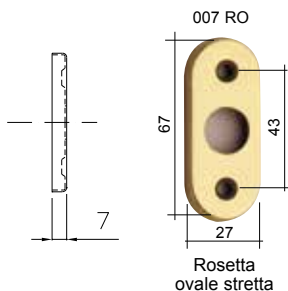
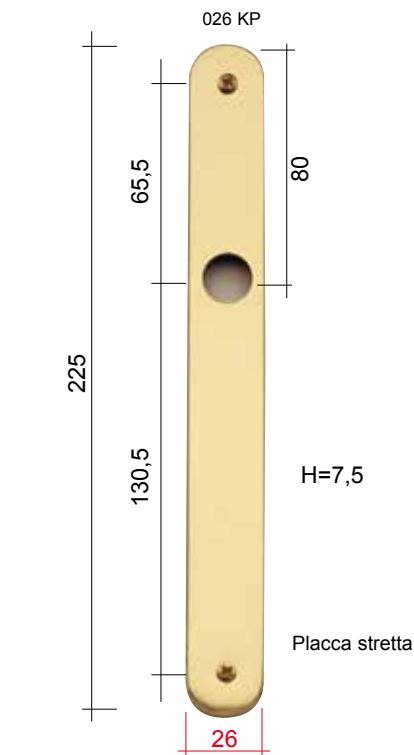

026 IP BASSA

IMPUGNATURA PER MANIGLIA / LEVER HANDLE

Impugnatura speciale con collo basso
 Special lever handle with low neck

A richiesta può essere montata su ogni nostra placca o rosetta
 On request it can be mounted on all our plates or roses

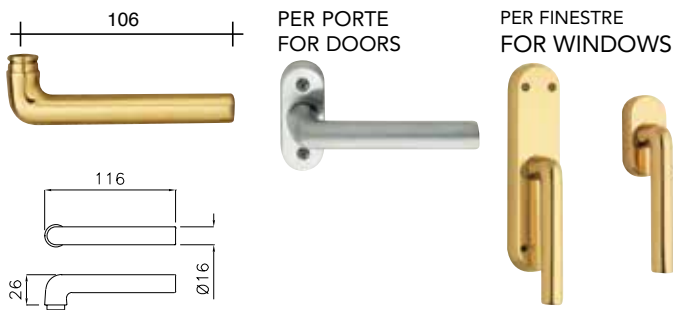

PORTE REI info tecniche

GUARNITURA IN OTTONE PER SOSTITUZIONE MANIGLIE SU PORTE REI
FORNITE PER SPESSORE PORTA DA mm 38 a mm 60



30 MP P30

Foro yale d.72

SU QUESTE PLACCHE P30KP PUO' ESSERE
MONTATA QUALSIASI MANIGLIA
EXTRA PREZZO SU VERSIONE CON
PLACCA BASE € 12,73



PRIMA
con maniglia in
plastica nera



DOPO
con maniglia in
ottone "Reguitti"

30MPP30 Maniglia con placca P30 con
foro chiave PATENT o YALE

LV	OSC OC
•	•

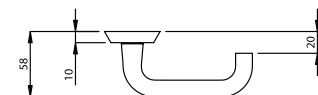
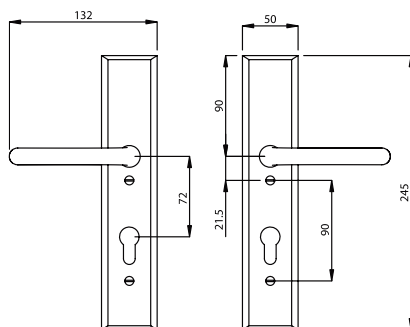

30 MP P30

Foro chiave patent d.72

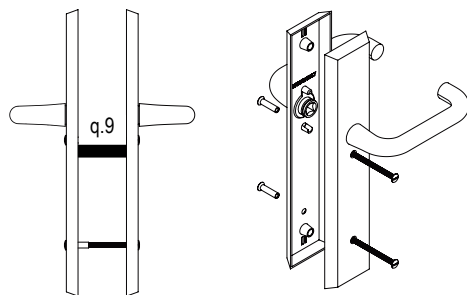



NUOVO DK 024 CON FERRO AUTOREGOLANTE
New DK 024 with self-adjusting spindle

PRATICO - SEMPLICE - COMODO - VELOCE - SOLIDO
PRACTICAL - SIMPLE - HANDY - FAST - RESISTANT

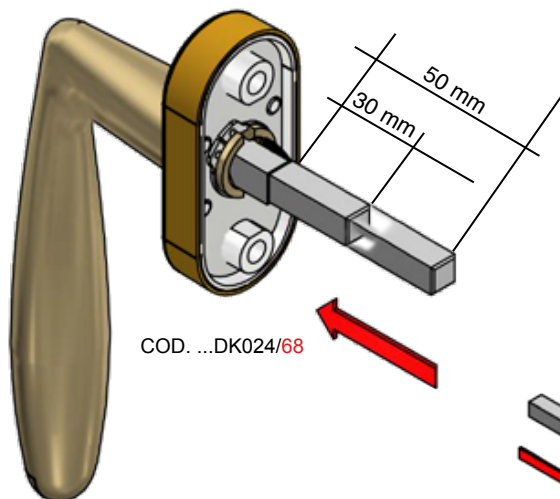

COD. ...DK024/68

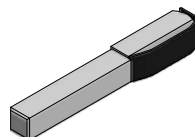

B737F5825CM3D € 1,30
Nuovo ferro con molla per autoregolazione
New self-adjusting spindle





AUTOREGOLAZIONE DEL FERRO

Avvitando le viti il ferro si adatta automaticamente e gradualmente alle diverse profondità dei profili delle finestre.

SELF-ADJUSTING SPINDLE

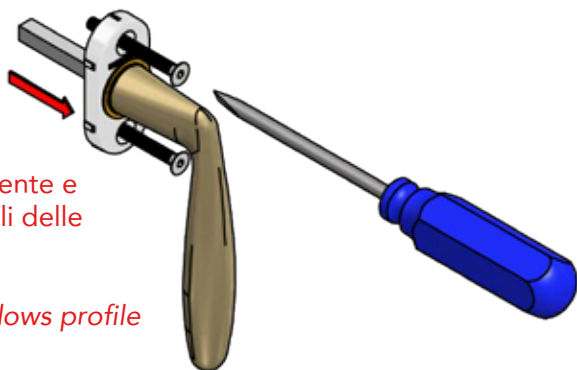
Spindle automatically adjusts to different windows profile depths by simply tightening the screws.



con movimento in METALLO a 8 SCATTI  preassemblato all'impugnatura per una INSTALLAZIONE RAPIDA, SENZA GRANO e con FERRO AUTOREGOLANTE.

With pre-assembled metal mechanism to windows levers for a faster mounting, with self-adjusting spindle.

APPLICAZIONE STANDARD
STANDARD MOUNTING

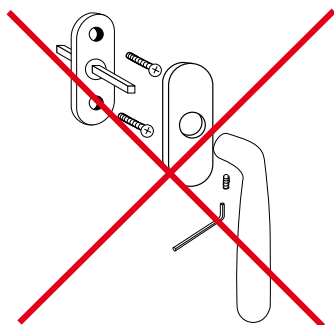

APPLICAZIONE RAPIDA DK 024
DK 024 FAST MOUNTING



NO



NO



OK



A RICHIESTA - ON REQUEST

NUOVO DK 024 CON FERRO A PRESSIONE
New DK 024 with pressure-adjustable spindle

PRATICO - SEMPLICE - COMODO - VELOCE - SOLIDO
PRACTICAL - SIMPLE - HANDY - FAST - RESISTANT

con movimento in METALLO a 8 SCATTI  preassemblato all'impugnatura per una **INSTALLAZIONE RAPIDA**,
SENZA GRANO e con FERRO A PRESSIONE.

With pre-assembled metal mechanism to windows levers for a faster mounting, and PRESSURE-ADJUSTING SPINDLE.

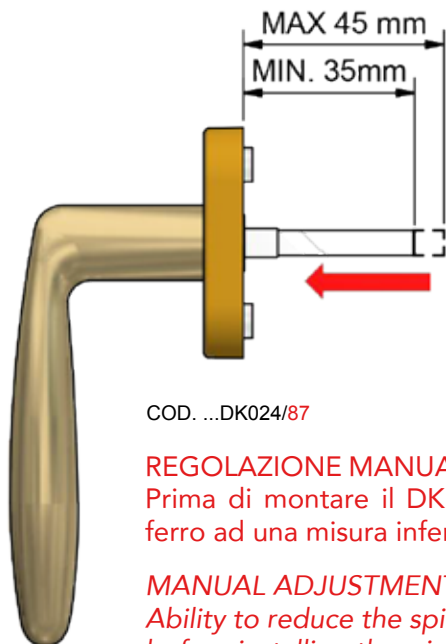

COD. ...DK024/87

A richiesta possibilità di fornire
ulteriori sporgenze ferro
*Different spindle projections
available on request*

REGOLAZIONE MANUALE DELLA SPORGENZA DEL FERRO
Prima di montare il DK sulla finestra, è possibile portare il
ferro ad una misura inferiore (max -10 mm)

MANUAL ADJUSTMENT
*Ability to reduce the spindle projection (by 10mm maximum)
before installing the window handle*



Fase 1
Impostare il ferro alla
sporgenza desiderata
*Set the spindle desired
projection*

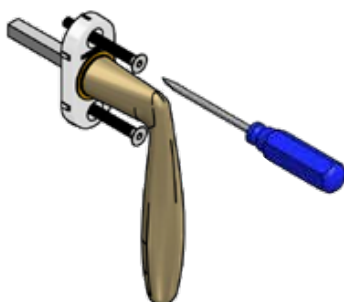

Fase 2
Montare il DK sul
serramento
*mount the DK on the
window*

APPLICAZIONE RAPIDA DK 024
DK 024 FAST MOUNTING



SECURBLOCK

il DK autobloccante di **REGUCCI**
antiveffrazione con pulsante e adattabile a tutti i DK a Catalogo



*the self-locking **REGUCCI** DK
safety window handle with push button, available on all DK ranges*

Esempi di Applicazione
Examples of Application

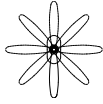

8 positions



171 DK 075



124 DK Q75



171 DK 074

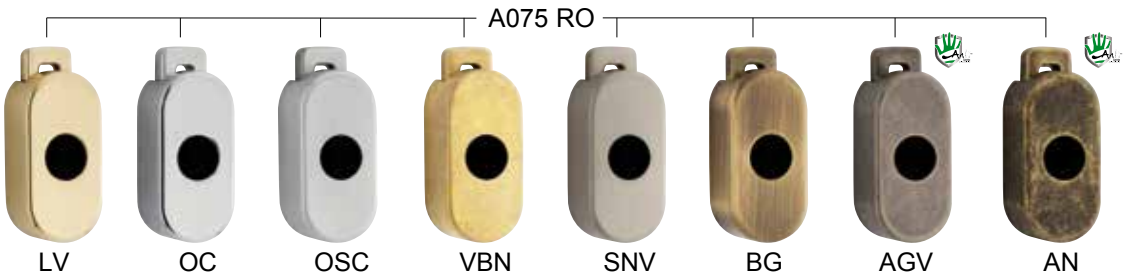

A075 RO

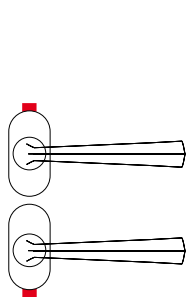

POSIZIONE DEL PULSANTE
A SCELTA SIA IN ALTO CHE
IN BASSO

*PUSH BUTTON POSITION,
POSSIBLE ON TOP OR AT THE
BOTTOM*

BLOCCATO
Locked

Dispositivo Sempre
ATTIVO
Device always active

BLOCCATO
Locked

BLOCCATO
Locked



A richiesta sistema con possibilità
di rendere inattivo il pulsante, per
finestre ad apertura gestita

*Available on request with the
possibility of inactivating temporarily
the push button for a controlled
opening system environment*





SECURBLOCK

il DK autobloccante di **REGUITTI**

antiefrazione con pulsante e adattabile a tutti i DK a Catalogo

*the self-locking **REGUITTI** DK*

safety window handle with push button, available on all DK ranges

Per impedire l'apertura della finestra alle manomissioni esterne della ferramenta



CARATTERISTICHE:

1. Sistema applicabile a tutte le nostre maniglie
2. Disponibile in tutte le finiture Reguitti
3. Tasto di consenso con finitura uguale alla rosetta
4. Movimento in metallo
5. Semplicità nel funzionamento, nel montaggio sul serramento, nell'intercambiabilità delle rosette esistenti
6. Intercambiabilità su tutti i DK già nel Vostro magazzino

FEATURES:

1. System suitable to all of our handles
2. Available in all Reguitti finishes
3. Push button with the same finish as the rosette
4. Metal Mechanism
5. Simple operation and easy window assembly, and interchangeability with existing rosettes
6. Interchangeability with all the DK already in your warehouse

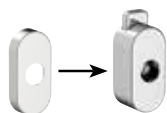

015 RO 0A075 RO

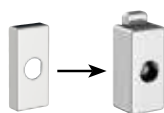

Q15 RO AQ75 RO

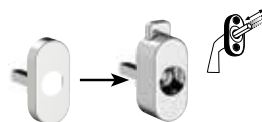

024 RO A074 RO

7. oltre a quelli montati e già installati sulle vostre finestre

7. in addition to those already installed as shown below:

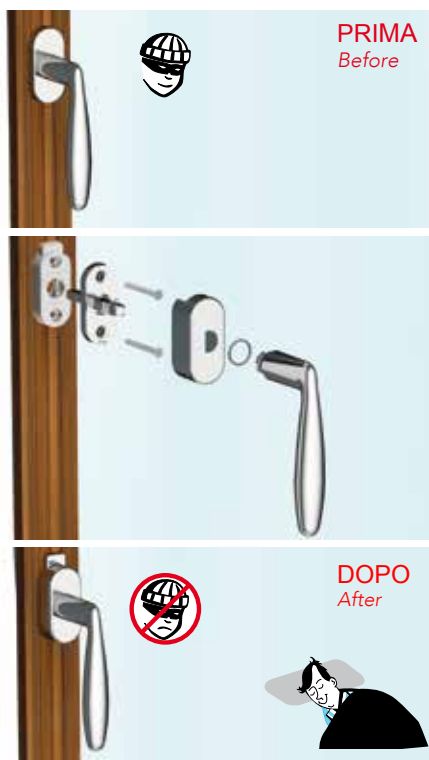

FASE 1 - STEP 1

Rimuovere il vecchio DK
svitando le viti

*Remove the existing DK
unscrewing the screws*

FASE 2 - STEP 2

Applicare il meccanismo
SECURBLOCK

*Apply the mechanism
SECURBLOCK*

FASE 3 - STEP 3

Rimontare il DK utilizzando
l'apposita rosetta

*Replace the DK using the
appropriate rosette*



SECURBLOCK

il DK autobloccante di **REGUITTI**
antieffrazione con pulsante e adattabile a tutti i DK a Catalogo



the self-locking **REGUITTI** DK
safety window handle with push button, available on all DK ranges

Rosette per dk con pulsante (montaggio con viti e grano)



8 positions

A075 RO

AQ75 RO

ø 16

8 positions

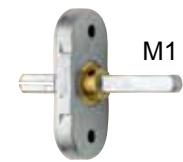

M1

ø8 int./ø7x 65 est.
senza bussole

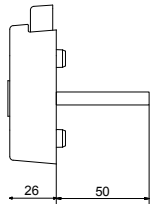

SPORGENZA FERRO

Disponibile l'abbinamento per
ogni maniglia
Calcolo prezzo rispetto DK Standard
Available for all matching handles
Pricing calculation compare to our standard DK

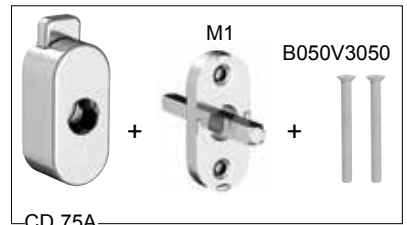

CD 75A

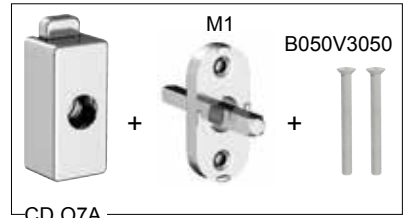

CD Q7A



ROSETTA CON PULSANTE DI SICUREZZA PER DK / ROSETTE WITH SAFETY PUSH BUTTON DK

		LV BG	OSC OC	AN	AGV	PVD	SNV
A075 RO	Rosetta DK con pulsante - senza movimento	•	•	•	•	•	•
AQ75 RO	Rosetta DK con pulsante - senza movimento	•	•	•	•	•	•
CD 75A	Set con rosetta 075 RO + M1 ø8 int./ø7 x 65 est. s/bussole + 2 viti M5x50	•	•	•	•	•	•
CD Q7A	Set con rosetta Q75 RO + M1 ø8 int./ø7 x 65 est. s/bussole + 2 viti M5x50	•	•	•	•	•	•
M1	Movimento DK a 8 scatti ø8 int./ø7 x 65 est. s/bussole				•		
B050V3050	Vite M5 x 50				•		

SECURBLOCK

il DK autobloccante di **REGUITTI**
antiveffrazione con pulsante e adattabile a tutti i DK a Catalogo



*the self-locking REGUITTI DK
safety window handle with push button, available on all DK ranges*

Rosette per dk con pulsante (montaggio con viti)
Rosettes for dk with push-button (to be assembled with screws)

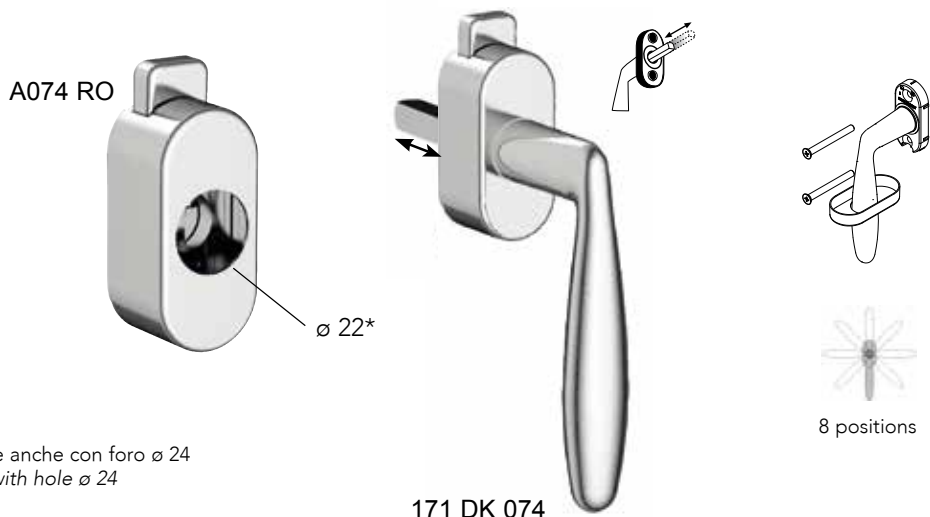

* Disponibile anche con foro $\varnothing 24$
* Available with hole $\varnothing 24$

Disponibile su maniglie e finiture selezionate
Calcolo prezzo rispetto DK Standard

*Available for handles and finish mentioned
Pricing calculation compare to our standard DK*

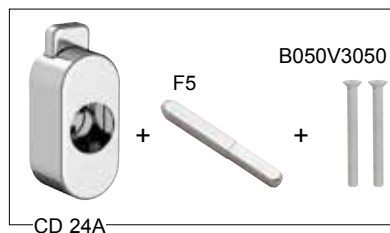

ROSETTA CON PULSANTE DI SICUREZZA PER DK / ROSETTE WITH SAFETY PUSH BUTTON DK		LV BG	OSC OC	AN	AGV	PVD
A074 RO	Rosetta DK con pulsante - senza movimento	•	•	•	•	•
CD 24A	Set con rosetta 074 RO + Ferro F5 $\varnothing 8 \times 10$ / $\varnothing 7 \times 75$ + 2 viti M5x50	•	•	•	•	•
F5	Ferro $\varnothing 8 \times 10$ / $\varnothing 7 \times 75$			•		
B050V3050	Vite M5 x 50				•	

DK C67 - C70 info tecniche

DISPOSITIVO ANTI EFFRAZIONE CON CHIAVE E CILINDRO SAFETY WINDOW HANDLE WITH CYLINDER AND KEY

completo di maniglia...

DISPOSITIVI ANTI-EFFRAZIONE CON CHIAVE E CILINDRO STESSA CIFRATURA che funzionano con stessa chiave (KA) con meccanismo in metallo e ferro 8/7x35 o 40 mm. Disponibile meccanismo in metallo e ferro 8/7x80 mm da tagliare a misura.

SAFETY WINDOW HANDLES WITH CYLINDER AND KEY ALIKE SYSTEM WITH 1 KEY FOR CYLINDER (KA) with metal mechanism 8/7x35 or 40 mm spindle. Available metal mechanism 8/7x80 mm spindle to be cut according to size requested.



192 DK C70-ZSC



900 DK C67-AGV

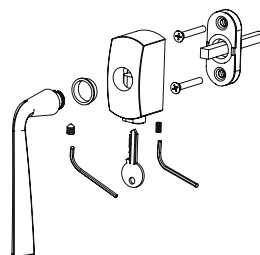

7M

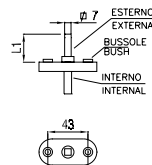

L1=35-40-55-80

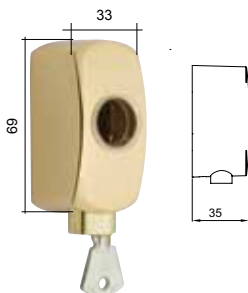

C70 RO-LV



OC



OSC

vedi capitolo "SOLUZIONI TECNICHE E COMPONENTI"
see chapter "TECHNICAL SOLUTIONS AND COMPONENTS"

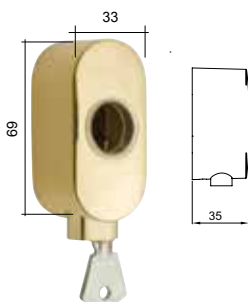

C67 RO-LV



OC



OSC



AN



BG



AGV



VBN

M1



con bussole
with bushes

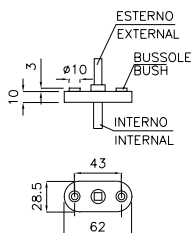

MOVIMENTO IN METALLO A 4 SCATTI PER D.K. / METAL MECHANISM WITH 4 RELEASES

		senza bussole without bushes €	con bussole with bushes €
	M1	•	•
NEW	M1	•	•
NEW	M1	•	•
	M1	•	•
	M1	•	•
	M1	•	•
NEW	M1	•	•

SPECIFICARE / PLEASE SPECIFY:

1. SE IL FERRO QUADRO INTERNO DEVE ESSERE 7 O 8
IF INTERNAL SQUARE SPINDLE IS REQUESTED 7 OR 8
2. LA LUNGHEZZA DEL FERRO QUADRO 7 ESTERNO
LENGTH OF EXTERNAL SQUARE SPINDLE 7
3. SE IL MOVIMENTO DEVE ESSERE CON O SENZA
BUSSOLE IF MECHANISM IS REQUESTED WITH OR
WITHOUT BUSHES

M1 - 8 SCATTI

Adatto per tutti i nostri
DK015 - DKQ15 - DK075 e DKQ75
Fissaggio con grano

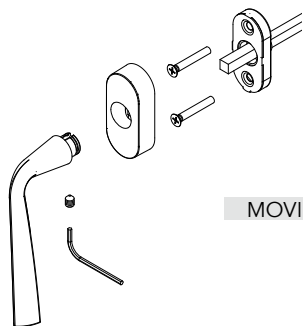

A RICHIESTA
movimenti a 8 scatti per
serramenti con **microventilazione**.

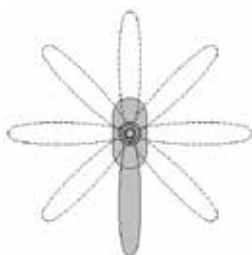

Extra prezzo per
...DK015 e per ...DKQ15 a 8 scatti € 0,80
rispetto ai DK a 4 scatti

Extra price for
...DK015 and for ...DKQ15 with 8 releases
€ 0,80 from price of DK with 4 releases

MOVIMENTO IN METALLO A 8 SCATTI PER D.K. / METAL MECHANISM WITH 8 RELEASES

		senza bussole without bushes €	con bussole with bushes €
NEW	M1	•	•
NEW	M1	•	•
NEW	M1	•	•
NEW	M1	•	•
NEW	M1	•	•

Certificazione EN13126-3_Certification EN 13126-3

Standardizzazione europea per maniglie per finestre e porte finestre_
European standardisation for windows and door height windows hardware

Sistema DK_System DK

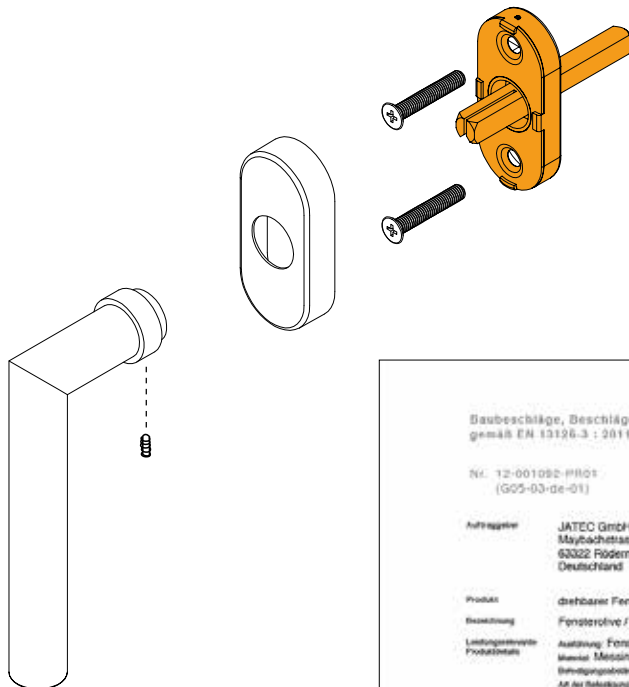

DIN EN13126-3

Questa parte della EN 13126 stabilisce i requisiti e i metodi di prova per la durabilità, la forza, la sicurezza e la funzionalità di maniglie per finestre e porte finestre. La norma si applica a maniglie Dreh Kipp (DK) anta ribalta ed a battente.

This part of EN 13126 specifies the requirements and test procedures for durability, strength, security and functionality of Tilt and Turn-Only window handle door height windows. The technical specifications are valid for Dreh Kipp (DK).

Sistema disponibile con ros. 015 - Q15 - 075 - Q75
Available system wit roses 015 - Q15 - 075 - Q75

Baubeschläge, Beschläge für Fenster und Fenstertüren
gemäß EN 13126-3 : 2011

Nr. 12-001092-PRO1
(G05-03-De-01)

Auftraggeber: JATEC GmbH
Maybachstraße 4
63032 Rödermark
Deutschland

Produkt: drehbares Fenstergriff

Bezeichnung: Fenstergriffe / System DK / 171/015-A171DK015

Leistungsmerkmale / Produktinhalt: Ausführung: Fenstergriff mit Getriebe,
Material: Messing,
Befestigungsbohrer: 43 mm,
Art der Befestigung: Verschraubung
Anzahl der Befestigungselemente: 2 Stück,
Befestigungselement: metrische Schrauben M5 x 40 mm,
Griffhöhe: 19,0 mm,
Grifflänge: 112,2 mm,
Griffbreite (B x L x H): 28,0 mm x 62,2 mm x 10,5 mm

Bestandteile: Keine

Eigenschaften:
Klassifizierung gemäß EN 13126-3 : 2011

Die Anwendungskategorie	Die Anwendungskategorie	Die Anwendungskategorie	Die Anwendungskategorie	Die Anwendungskategorie	Die Anwendungskategorie	Die Anwendungskategorie	Die Anwendungskategorie
2	5/100	-1	0	1	2	0	3/31

if Rosenheim
30. August 2012

Andreas Matzch, Dipl.-Ing. ifR
Produktionsleiter
Rosenheim

Pascal Jaeger
Fischer-Chef, Dipl.-Ing. ifR
Produktionsleiter
Rosenheim

ift ROSENHEIM

Grundlagen:
EN 13126-1 : 2011
EN 13126-2 : 2011
Prüfnormen:
EN 13126-3 : 2011

Entgeltfreie individuelle Fertigung bei D: 089 378 2000
Standardisierung

Versandfertigstellungsdatum:
Dieses Produkt wird zum Nachweis der Anforderungen hinsichtlich der Produktqualität gefertigt gemäß EN 13126-3 : 2011.
Die Bestimmungen von EN 13126-3 : 2011, um die Einhaltung und Nachweisleistung der Eigenschaften nach zu beweisen.

Übersicht:
Die genannten Daten sind die Mindestanforderungen an die Ausführung der Bauteile. Die Ausführung ist nur dann als Produkt annehmbar, wenn die Ausführung nach EN 13126-3 : 2011 erfüllt ist. Das Ergebnis kann unter Beachtung der entsprechenden Prüfverfahren der Produktion in Eigenverantwortung des Herstellers überprüft werden. Eine Prüfungserklärung ermöglicht dem Auftraggeber die weitere Ausführung von Qualitätsmaßnahmen. Die Verantwortung der Einhaltung der Anforderungen an die Ausführung des Produktes liegt bei dem Auftraggeber. Das Produkt ist für die Ausführung im Rahmen der angegebenen Bedingungen geeignet. Die Ausführung ist nur dann als Produkt annehmbar, wenn die Ausführung nach EN 13126-3 : 2011 erfüllt ist. Das Ergebnis kann unter Beachtung der entsprechenden Prüfverfahren der Produktion in Eigenverantwortung des Herstellers überprüft werden. Eine Prüfungserklärung ermöglicht dem Auftraggeber die weitere Ausführung von Qualitätsmaßnahmen. Die Verantwortung der Einhaltung der Anforderungen an die Ausführung des Produktes liegt bei dem Auftraggeber. Das Produkt ist für die Ausführung im Rahmen der angegebenen Bedingungen geeignet.

Veröffentlichungstermin:
Es gilt die in Abschnitt "Veröffentlichung" des Produktdatenblattes "Das Produkt" angegebene Versionnummer zu verwenden. Der Hersteller ist nach Anlage 17 Ziffer

if Rosenheim - Rosenheim
Produktionsleiter
Rosenheim

Produktionsleiter
Rosenheim

Produktionsleiter
Rosenheim

Produktionsleiter
Rosenheim

Vedi pag. 12-13
See page 12-13



183 MR 015

Esempio di applicazione
 su art. 183

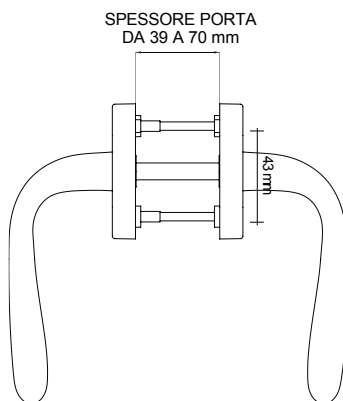

mm 38



Possibilità di abbinare
 ogni maniglia alla
 versione con collo
 basso da una parte

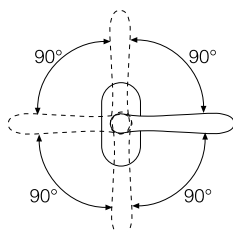

Coppia maniglia con rosetta 015 mm 65x31 e movimento a 4 scatti - q.7 senza bocchette
 Pair lever handle on rose 015 mm 65x31 and mechanism with 4 releases - q.7 without rose for key

MR Q15



142 MR Q15

Esempio di applicazione
 su art. 142

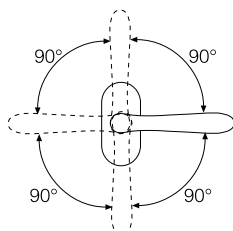
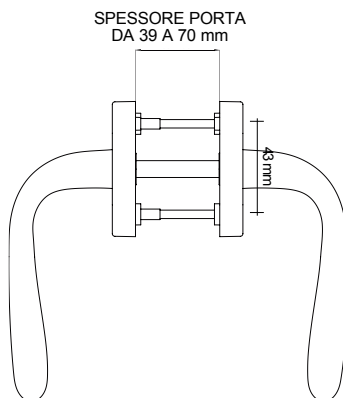

Coppia maniglia con rosetta Q15 mm 65x31 e movimento a 4 scatti - q.7 senza bocchette
 Pair lever handle on rose Q15 mm 65x31 and mechanism with 4 releases - q.7 without rose for key



183 MR 024

Esempio di applicazione su art. 183

SPESSORE PORTA DA 39 A 70 mm

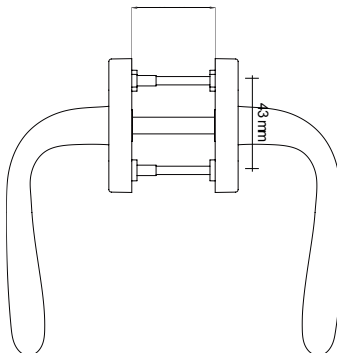

mm 38



Possibilità di abbinare ogni maniglia alla versione con collo basso da una parte

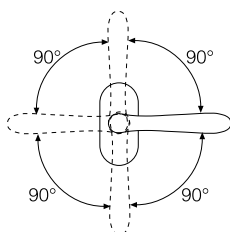

Coppia maniglia con rosetta 024 mm 65x31 e movimento a 4 scatti - q.7 senza bocchette
Pair lever handle on rose 024 mm 65x31 and mechanism with 4 releases - q.7 without rose for key

PREZZO = A 2 ... DK 024 DELL'ARTICOLO SCELTO + 2,40

art. C24 RO



C24 RO - OC

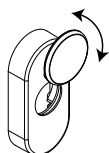

STEP 1

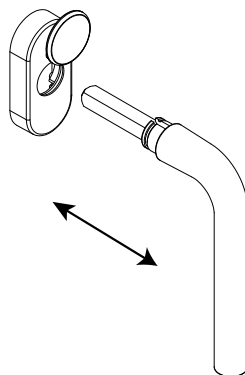

STEP 2

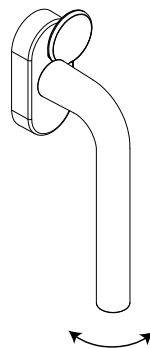

STEP 3



SISTEMA DI MONTAGGIO STANDARD
STANDARD MOUNTING SYSTEM

VERSIONI / VERSIONS

ROSETTA CIECA PER IMPUGNATURA ESTRAIBILE

C24 RO Rosetta per impugnature DK estraibili
Rose for removable DK lever

Finiture
Finishes

LV
BG

OC
OSC

€

€

•

•

art. **CD 63Y**

SET 2 BOCCHETTE COPRITI YALE PER PROFILI STRETTI
 SET 2 ROSES WITH EURO PROFIL CYLINDER HOLE (YALE)
 FOR NARROW PROFILES



000 CD 63Y

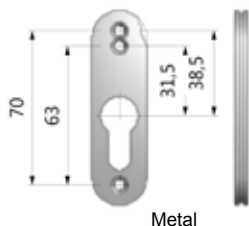

Metal

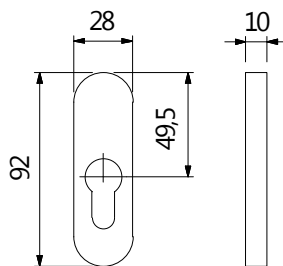

SET 2 BOCCHETTE OVALI

000 CD 63Y

Set 2 bocchette ovali
 Set 2 oval roses

LV BG	OC OSC	AGV	AN	
€	€	€	€	
•	•	•	•	1

art. **CD 7QY**

SET 2 BOCCHETTE COPRITI YALE PER PROFILI STRETTI
 SET 2 ROSES WITH EURO PROFIL CYLINDER HOLE (YALE)
 FOR NARROW PROFILES



000 CD 7QY

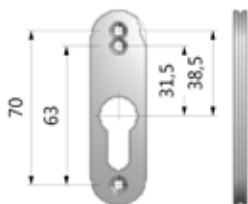

Metal

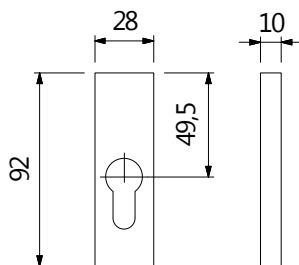

SET 2 BOCCHETTE RETTANGOLARI

000 CD 7QY

Set 2 bocchette rettangolari
 Set 2 rectangular Roses

OC OSC	SNV	
€	€	
•	•	1

ADATTATORI PER DREH KIPP

Adapters for dreh kipp



RIDUZIONI FORO DA Ø12 A Ø10 PER BUSSELE DK / NYLON SLEEVES FROM Ø12 TO Ø10 FOR WINDOW HANDLE

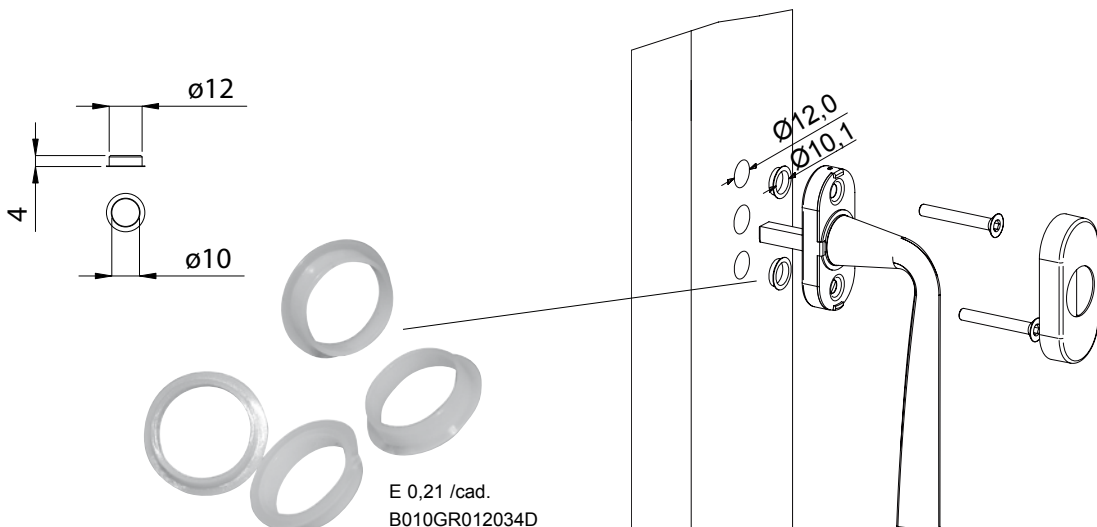

DA UTILIZZARE NEL CASO IN CUI I FORI DEL SERRAMENTO SIANO Ø12 ANZICHE' Ø10

esempio di applicazione SUL SERRAMENTO
mounting example ON WINDOW

ADATTATORI PER DREH KIPP

Adapters for dreh kipp

BASE PER PROFILI IN ALLUMINIO / BASE FOR ALUMINIUM PROFILES



Per adattare tutti i nostri dk sui profili tondi in alluminio
Per serramenti in alluminio o legno-alluminio

GRIGIO NERO ORO

ADATTATORE PER DK

DK0PT

Adattatore in nylon per profili in alluminio



100

APPLICAZIONE DI MOVIMENTO DK A 4 SCATTI PER FINESTRE CON APERTURA AD “ANTA RIBALTA” SU PLACCHE MARTELLINA



L'utilizzo del movimento DK 025 speciale in larghezza e spessore, di esclusiva fabbricazione REGUITTI, consente al serramentista di installare guarniture dk (con qualsiasi impugnatura) anche su placca da martellina come raffigurato in pagina e senza necessità di fresature di adattamento grazie al completo incasso del gioco nello spessore della placca.

Possibile su placche 040 KM, 137 KM, 189 KM
in quanto creata sul retro adeguata sede

ESEMPI:



es.: 40 TK 040



es.: 40 DK 040



es.: 37 TK 137



es.: 37 DK 137

art. 124 Q-ARTE DW Q15

design: Studio Reguitti
 materiale: Impugnatura Zama
 material: Lever Zamak
TeKnoMetal
 Linea in zama

DK CON CHIAVE, CILINDRO AZIONABILE DA UNICA CHIAVE (KA)
 E MOVIMENTO A 4 SCATTI* CON ROSETTA DK Q15

4 positions* window handle with cylinder and key alike (KA)
 on rectangular rose Q15



124 DW Q15 - ZSC



124 DW Q15 - PVD

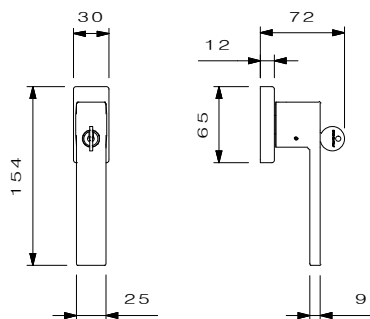

Posizione non bloccabile
 No lockable position

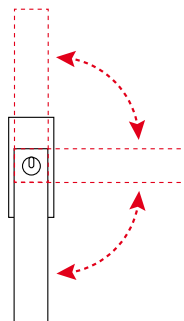

Posizione Bloccabile
 Lockable position

Posizione non bloccabile
 No lockable position

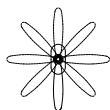

*Possibilita a richiesta
 movimento a 8 scatti
 Extra prezzo € 0,80
 On request 8 Positions
 Extraprice € 0,80



124 CH
 Chiave universale
 per cilindro 124 Key
 alike for cylinder

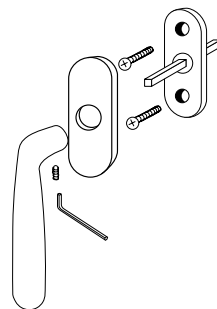

VERSIONI / VERSIONS



Finiture
 Finishes

ZCR

ZSC

SNV

PVD

PVD

INOX



DREH KIPP / DREH KIPP

124 DW Q15 Dreh kipp con rosetta Q15 mm 65x31 con cilindro su impugnatura
 Dreh Kipp on rose with cylinder on handle

€

€

€

€

2

art. 124

Q-ARTE DW Q90

design: Studio Reguitti
 materiale: Impugnatura Zama
 material: Lever Zamak

TeKnoMetal
 Linea in zama

DK CON CHIAVE, CILINDRO AZIONABILE DA UNICA CHIAVE (KA)
 E MOVIMENTO A 4 SCATTI* CON PLACCA MARTELLINA Q90
 4 positions* window handle with cylinder and key alike (KA)
 on rectangular plate Q90



124 DW Q90 - ZSC



124 DW Q90 - PVD

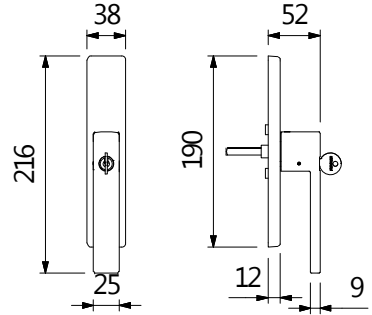

Posizione non bloccabile
 No lockable position

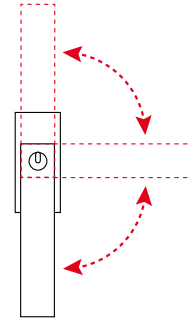

Posizione Bloccabile
 Lockable position

Posizione non bloccabile
 No lockable position

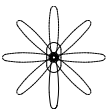
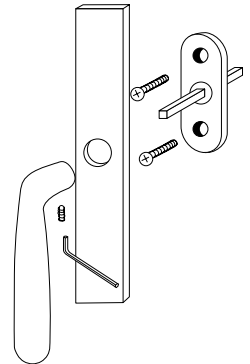

*Possibilità a richiesta movimento a 8 scatti

On request 8 Positions

VERSIONI / VERSIONS



Finiture Finishes	ZCR	ZSC	SNV	PVD PVD INOX	
DREH KIPP / DREH KIPP	€	€	€	€	
124 DW Q90	•	•	•	•	2

Dreh kipp con placca Q90 mm 190x38 con cilindro su impugnatura
 Dreh Kipp on plate with cylinder on handle

art. 124

Q-ARTE GW SW Q90

design: Studio Reguitti
 materiale: Impugnatura Zama
 material: Lever Zamak

CREMONESE CON CHIAVE, CILINDRO E MOVIMENTO M3
 MARTELLINA CON CHIAVE, CILINDRO E MOVIMENTO M3/53
 CON PLACCA MARTELLINA Q90 CON CILINDRO AZIONABILE DA UNICA CHIAVE (KA)

TeKnoMetal
 Linea in zama



124 SW Q90 - ZSC
 124 GW Q90 - ZSC



124 SW Q90 - PVD
 124 GW Q90 - PVD



124 CH
 Chiave universale
 per cilindro 124 Key
 alike for cylinder

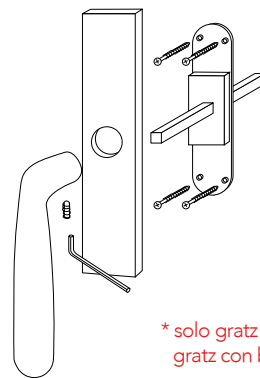
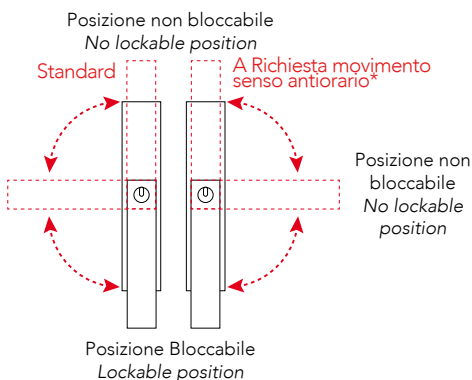
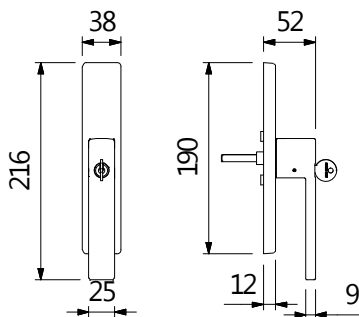

* solo gratz con bussolle e gratz con bussolle + ø7

VERSIONI / VERSIONS



Finiture
 Finishes

ZCR

ZSC

SNV

PVD
 PVD
 INOX



MARTELLINA / WINDOW HANDLE WITHOUT MECHANISM

	€	€	€	€
124 SW Q90 Martellina con placca Q90 mm 190x38 con cilindro su impugnatura Martellina on plate with cylinder on handle	•	•	•	• 2

CREMONESE / WINDOW HANDLE WITH MECHANISM

	€	€	€	€
124 GW Q90 Cremonese con placca Q90 mm 190x38 con cilindro su impugnatura Cremon on plate with cylinder on handle	•	•	•	• 2

Info tecnica - MK Sistema di DREH KIPP con impugnatura maniglione

Technical info - MK System DREH KIPP with pull handle grip

Fornitura su richiesta di Dreh Kipp con
impugnature dei seguenti maniglioni:
*On request we can supply the window handle
Dreh Kipp with mechanism with pull handles grip:*

mm 235

mm 230

mm 230

mm 230

mm 230

302 MK Q15

φ.7

mm.43

313MK...

305MK...

124MK...

426MK...

171MK...

mm 230

mm 225

mm 221

mm 171

mm 170

mm 170

mm 170

mm 170

30MK...
In Ottone
Only Brass

307MK...

J04MK...

308MK...

306MK...

311MK...

302MK...

303MK...

...Q15

...015

...C70

...C67

...Q13

...Q75

...075

+6%

305MD011

305MKQ75

Placche per ristrutturazioni Plates for renovations



Placche speciali per ristrutturazione con dimensioni maggiorate per coprire impronte preesistenti

Plates for substitution with oversized dimensions to cover preexisting signs

■ Per finestre - For windows

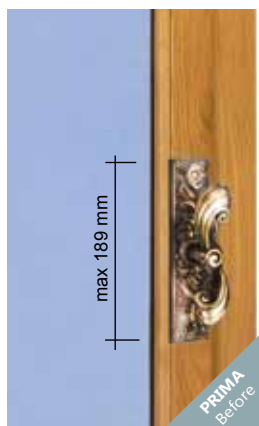

Cremonese obsoleto
Window handle obsolete



Dopo lo smontaggio
After disassembly



Nuovo cremonese
New window handle

189 KM PER FINESTRE

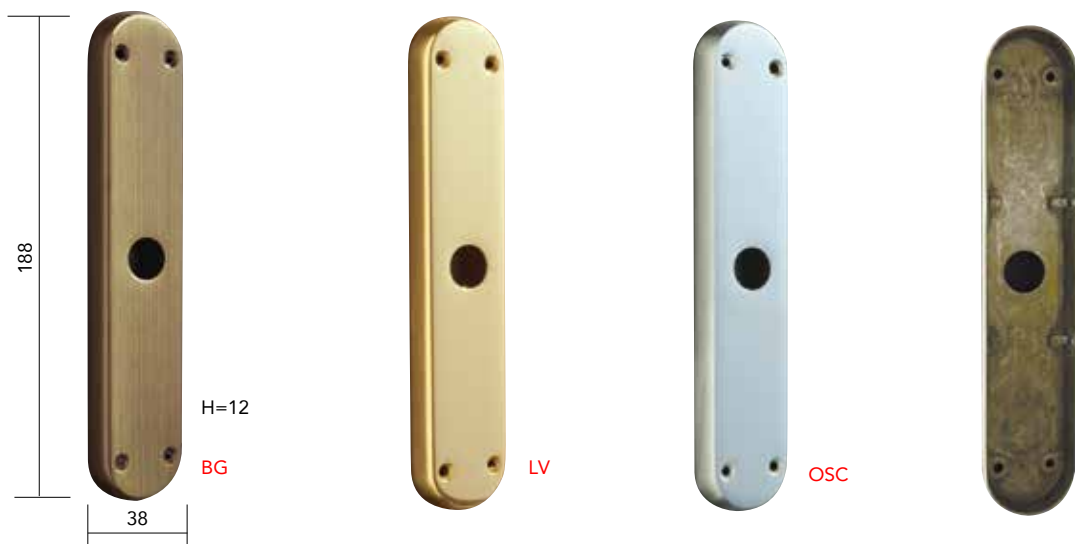

art. 189 KM



PLACCA SPECIALE PER SOSTITUZIONE
SPECIAL PLATE FOR SUBSTITUTION

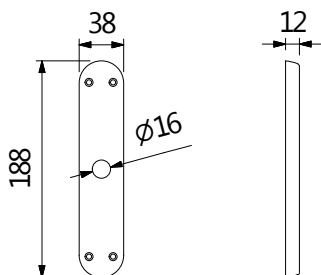

Placca per cremonese o Martellina
Plate for window handles

Dimensione maggiorata per coprire i segni preesistenti
Dimension oversized to cover preexisting signs

Adattabile ad ogni impugnatura
Suitable for every lever handle

Placca adatta a movimenti intercambiabili
Plate suitable to interchangeable movements



SISTEMA DI MONTAGGIO STANDARD
STANDARD MOUNTING SYSTEM



Adattabile ad ogni impugnatura / Suitable for every lever handle

art. Q90 KM



PLACCA SPECIALE PER SOSTITUZIONE
SPECIAL PLATE FOR SUBSTITUTION

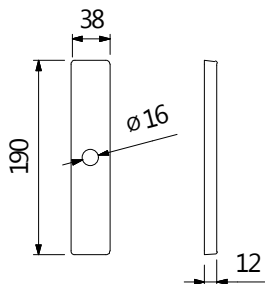

Placca coprivite per cremonese o Martellina
Cover screw plate for window handles

Dimensione maggiorata per coprire i segni preesistenti
Dimension oversized to cover preexisting signs

Adattabile ad ogni impugnatura
Suitable for every lever handle

Placca adatta a movimenti intercambiabili
Plate suitable to interchangeable movements



SISTEMA DI MONTAGGIO STANDARD
STANDARD MOUNTING SYSTEM



Adattabile ad ogni impugnatura / Suitable for every lever handles

art. 070 KM



PLACCA SPECIALE PER SOSTITUZIONE
SPECIAL PLATE FOR SUBSTITUTION

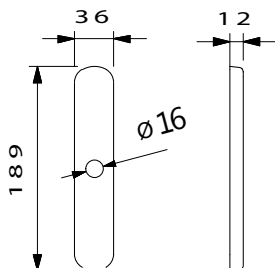

Placca per cremonese o Martellina
Plate for window handles

Dimensione maggiorata per coprire i segni preesistenti
Dimension oversized to cover the signs of pre-existing

Adattabile ad ogni impugnatura
Suitable for every lever handles

Placca adatta a movimenti intercambiabili
Plate suitable to interchangeable movements



SISTEMA DI MONTAGGIO STANDARD
STANDARD MOUNTING SYSTEM



Adattabile ad ogni impugnatura / Suitable for every lever handles



A RICHIESTA può essere montata su ogni nostro articolo / On REQUEST can be mounted on every our item
Placca adatta a movimenti intercambiabili M3 (a-b) / plate suitable to interchangeable movements M3 (a-b)
Placca adattabile con spessore a movimenti M1 per DK (c-d) / plate suitable to M1 movements for Dreh Kipp (c-d)

Esempi di applicazione:

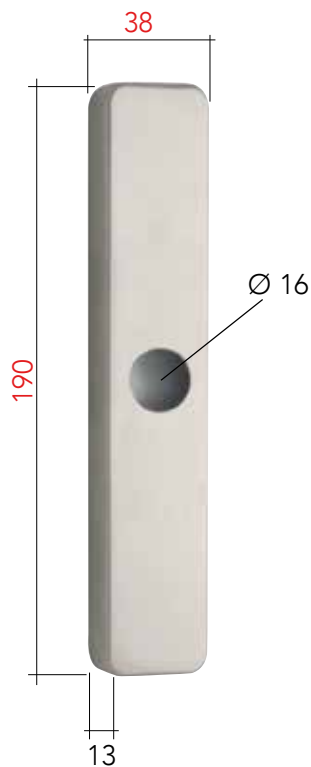

a) Cremonese / Martellina
impugnatura a T

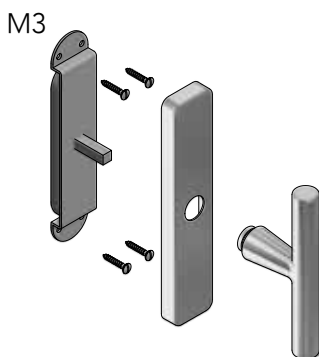

b) Cremonese \ Segretino
con gioco, impugnatura a maniglia

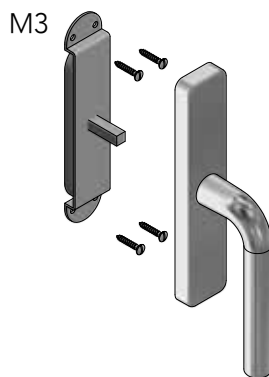

c) TK

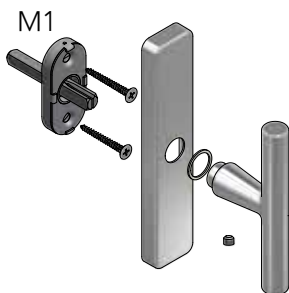

d) DK

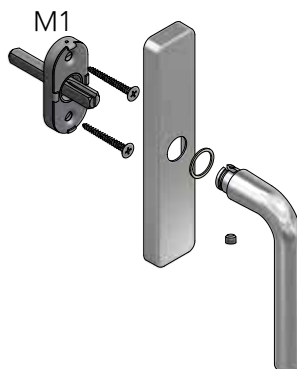

Extra prezzo di € 3,20 (se non già previsto dal listino) rispetto ai cremonesi con placca copriviti 070
Extra prezzo di € 1,00 (se non già previsto dal listino) rispetto ai cremonesi con placca copriviti Q13

Esempio:

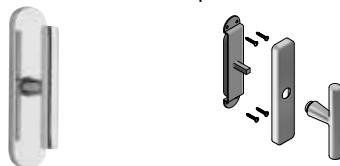

Esempio:
...DK015



Esempio:
...DKQ15

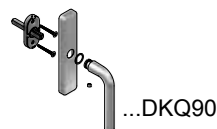

art. 190 CR 063



190 CR 063-LV



190 CR 063-NR



190 CR 063-AGV

Adattabile ad ogni
ns. impugnatura
Suitable to all our levers

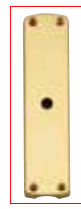

PER ASTE ESTERNE A VISTA
FOR OUTSIDE RODS

VERSIONI / VERSIONS



Finiture Finishes	LV BG	OC OSC	LR	NR	AN	AGV	
	€	€	€	€	€	€	

CREMONESE PER ASTE ESTERNE / WINDOW HANDLE MP MECHANISM FOR OUTSIDE RODS

190 CR 063	Cremonese con placca Window Handle on plate	063	mm 143x37 con gioco M.P. per aste esterne mm 143x37 with MP mechanism on outside rods

--	--	--	--	--	--	--	--

art. 410 AT - 411 NT - 411 NL



411 NT-LV



411 NL-LV



410 AT-LV



410 AT-AN



410 AT-AGV



Esempio di cremonese con
G.M.P. per aste esterne in opera

Installation example of window
handle with MP mechanism with
outside rods



VERSIONI / VERSIONS

ASTE ESTERNE IN OTTONE PER CREMONESI G. MP / BRASS OUTSIDE RODS FOR WINDOW HANDLES WITH MP MECHANISM

		LV	OC OSC	LR	AN BG	AGV	GREZZO	
410 AT 150	Asta mm 7x16 - Lungh. cm 150 Brass rods mm 7x16 - Lenght cm 150	•	•	•	•	•	•	12
410 AT 180	Asta mm 7x16 - Lungh. cm 180 Brass rods mm 7x16 - Lenght cm 180	•			AN		•	12
410 AT 200	Asta mm 7x16 - Lungh. cm 200 Brass rods mm 7x16 - Lenght cm 200	•		•		•	•	12

VERSIONI / VERSIONS

PASSANTI E FINALI PER ASTE ESTERNE ART.410 / LOOPS AND FINAL FITTINGS FOR OUTSIDE RODS

		LV BG	OC OSC	LR	AN	AGV	
411 NT	Solo passante mm 35x22 Loop fitting only mm 35x22	•	•	•	•	•	50
411 NL	Solo finale mm 35x22 Final fitting only mm 35x22	•	•	•	•	•	50

art. 190 CR 413



LV



NR

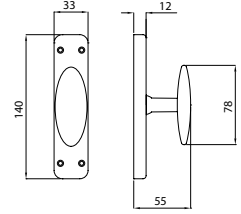

CREMONESE PER ASTE ESTERNE / WINDOW HANDLE MP MECHANISM FOR OUTSIDE RODS

190 CR 413 Cremonese con placca / Window Handle on plate 413 mm 140x33 con gioco M.P. per aste esterne / mm 140x33 with MP mechanism for outside rods

LV	NR	
•	•	2

NON PUO' ESSERE APPLICATA ALL'ASTA ART.410 mm 7X16 IN OTTONE, MA ALL'ASTA TONDA ART. 413
THIS ARTICLE CAN BE MOUNTED ONLY ON ROUND ROD ART. 413 AND NOT ON BRASS ROD ART. 410 MM 7X16

art. 413 AT - 413NT

NR

OTT. BRILL.

TROPICAL

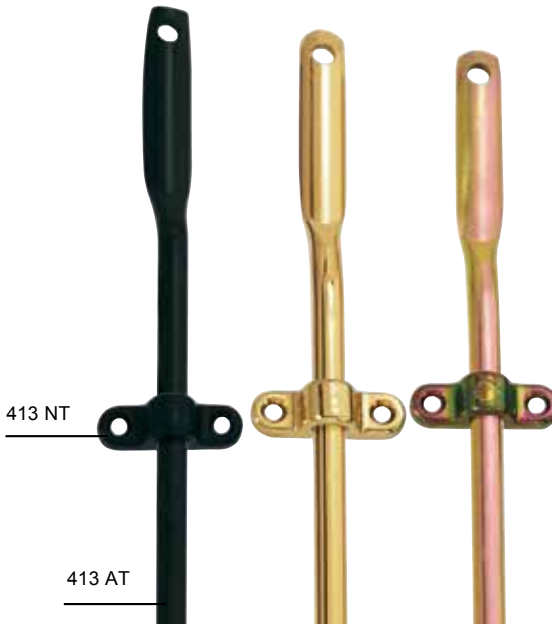

413 NT

413 AT

ASTE ESTERNE TONDE PER CREMONESE ART.190 CR 413 / IRON ROUND OUTSIDE RODS FOR ART. 190 CR 413

413 AT 160 Asta tonda Ø 10 con puntale schiacciato mm 6x14 lungh. cm. 160 / Outside rod Ø 10 for window handles with MP mech. - lenght cm. 160

OTT. BRILL.	TROPICAL	NR	
•	•	•	12

PASSANTE PER ASTA Ø10 ART.413 / LOOPS FOR ROD Ø10 ART.413

413 NT Solo passante mm 40x12 / Loop fitting only mm 40x12

OTT. BRILL.	TROPICAL	NR	
•	•	•	50

art.410 NL

design: Studio Reguitti
 materiale: Ottone
 material: Brass

Brass Class
 100% Offtone

Finale per aste esterne *Final fitting for outside rods*



Esempio di applicaione
 Installation example

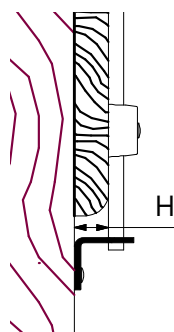
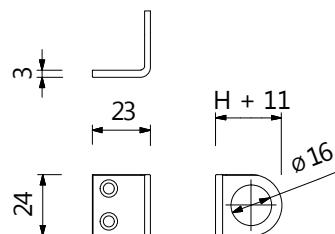

	H
410 NL A15	15
410 NL A18	18
410 NL A20	20
410 NL A22	22
410 NL A25	25



VERSIONI / VERSIONS



FINALE PER ASTE ESTERNE / FINAL FITTING FOR OUTSIDE RODS

		LV BG	OSC OC	LR VBN	AGV	AN	
410 NL A15	Finale per aste art.410 per battuta mm15 <i>Final fitting for mod. art.410 outside rod for thickness mm15</i>	•	•	•	•	•	50
410 NL A18	Finale per aste art.410 per battuta mm18 <i>Final fitting for mod. art.410 outside rod for thickness mm18</i>	•	•	•	•	•	50
410 NL A20	Finale per aste art.410 per battuta mm20 <i>Final fitting for mod. art.410 outside rod for thickness mm20</i>	•	•	•	•	•	50
410 NL A22	Finale per aste art.410 per battuta mm22 <i>Final fitting for mod. art.410 outside rod for thickness mm22</i>	•	•	•	•	•	50
410 NL A25	Finale per aste art.410 per battuta mm25 <i>Final fitting for mod. art.410 outside rod for thickness mm25</i>	•	•	•	•	•	50

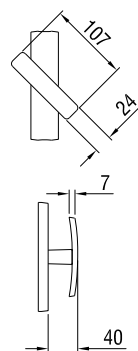

CREMONESE PER ASTE ESTERNE / WINDOW HANDLE MP MECHANISM FOR OUTSIDE RODS

			OSC	
061 CR 063	Cremonese con placca Window Handle on plate	063 mm 143x37 con gioco M.P. per aste esterne mm 143x37 with MP mechanism on outside rods	•	2
411 NT		Solo passante mm 35x22 Loop fitting only mm 35x22	•	50
411 NL		Solo Finale mm 35x22 Final fitting only mm 35x22	•	50
410 AT 150		Asta mm 7x16 - Lungh. cm 150 Brass rods mm 7x16 - Length cm 150	•	12

Porte interne e Finestre

interior DOORS AND WINDOWS



art. **16** FLORIDA

materiale: Ottone
material: Solid Brass

Brass Class
100% Ottone

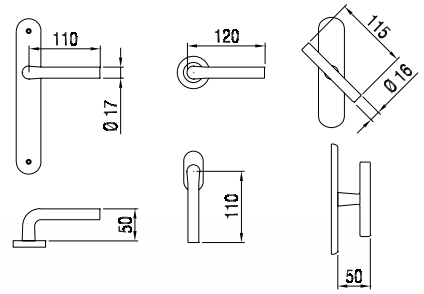

16 MR 005 OSC



16 MR 416 OSC



16 MR 004 NR



16 MR 005 LV



16 MR 004 OC



16 MR 009 LV



16 MR 007 OSC



16 MP 066 LV



16 MA 137 LV
16 CR 137 LV



16 MA 007 LV



MANIGLIA CON PLACCA / LEVER HANDLE ON PLATE

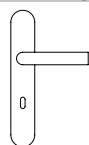

16 MP 066	Maniglia con placca Lever Handle on plate	066	mm 240x37	con molla with spring	•	•	•	1
16 MP 066	Maniglia con placca Lever Handle on plate	066	mm 240x37	con molla e grano with spring and grub screw	•	•	•	1
16 MP 026	Maniglia con placca Lever Handle on plate	026	mm 225x26	stretta con grano reduced with grub screw	•	•	•	1

MANIGLIA CON ROSETTA / LEVER HANDLE ON ROSE

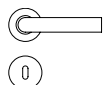

16 MR 004	Maniglia con rosetta Lever Handle on rose	004	mm Ø45x9	con molla e grano with spring and grub screw	•	•	•	2
16 MR 005	Maniglia con rosetta Lever Handle on rose	005	mm Ø50x8	tipo lusso con molla e grano lusso type with spring and grub screw	•	•	•	2
16 MR 007	Maniglia con rosetta Lever Handle on rose	007	mm 67x27	ovale stretta con grano oval and reduced with grub screw	•	•	•	2
16 MR 009	Maniglia con rosetta Lever Handle on rose	009	mm 62x32	ovale con molla e grano oval with spring and grub screw	•	•	•	1
16 MR 416	Maniglia con rosetta Lever Handle on rose	416	mm Ø45x9	con molla e grano with spring and grub screw	•	•	•	5

CREMONESE / WINDOW HANDLE WITH MECHANISM



16 CR 137*	Cremonese con placca Window Handle on plate	137	mm 167x40	con fori viti con gioco with holes for screws with mechanism	•	•	•	2
------------	--	-----	-----------	---	---	---	---	---

MARTELLINA / WINDOW HANDLE WITHOUT MECHANISM



16 MA 137*	Martellina con placca Window Handle on plate	137	mm 167x40	con fori viti q. 7 without mechanism with square-pin mm 7	•	•	•	2
16 MA 007	Martellina con rosetta Window Handle on rose	007	mm 67x27	q. 7 without mechanism with square-pin mm 7	•	•	•	6

DREH KIPP / DREH KIPP



16 DK 015	Dreh Kipp con rosetta Dreh Kipp on rose	015	mm 65x31	con movimento in metallo with metal mechanism	•	•	•	3
16 DK 024	Dreh Kipp con rosetta Dreh Kipp on rose	024	mm 65x31	c/mov. in metallo e quadro autoregolante with metal mec. and adjustable square-pin	•	•	•	3
16 DK 075	Dreh Kipp con rosetta Safety DK on rose	075	mm 64x30	con mov. securblock e pulsante di sicurezza with securblock system and push button	•	•	•	2

* Placca adatta a movimenti intercambiabili
Plate suitable to interchangeable movements



16 DK 015 LV



16 MP 026 LV

Per caratteristiche tecniche rosette vedi apposito capitolo soluzioni tecniche e componenti / For technical specifications rosettes see specific section technical solutions and components

A RICHIESTA / ON REQUEST:

- Mezza maniglia con placca o con rosetta (specificare se destra o sinistra) / Half lever handle on plate or on rose (to specify if right or left)
- Maniglia con rosette senza bocchette / Lever handle on rose without rose for key
- Coppie impugnature (CM) con grano e ferro senza rosette e senza bocchette / Pair levers (CM) with grub screws and square pin without rose and without rose for key
- Cremonesi e martelline con impugnatura a maniglia (segretini)
- Cremonese e martellina con placca coprivite e movimento intercambiabile

art. 26 COLLO BASSO

materiale: Ottone
material: Solid Brass

Brass Class
100% Ottone

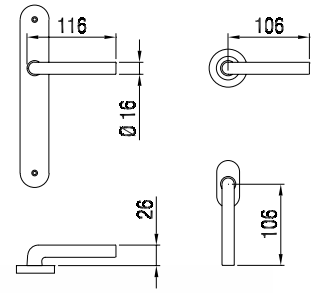

26 MR 003 OC



26 MR 009 LV



26 MR 007 OSC



26 MR 003 BG



26 MP 066 LV



26 SE 137 LV
26 SG 137 LV



26 DK 015 LV

VERSIONI / VERSIONS



Finiture
Finishes

LV BG

OSC
OC



MANIGLIA CON PLACCA / LEVER HANDLE ON PLATE

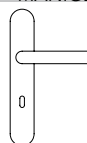

26 MP 066	Maniglia con placca Lever Handle on plate	066	mm 240x37	con grano with grub screw	•	•	1
26 MP 026	Maniglia con placca Lever Handle on plate	026	mm 225x26	"stretta" con grano "reduced" with grub screw	•	•	1

MANIGLIA CON ROSETTA / LEVER HANDLE ON ROSE

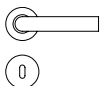

26 MR 003	Maniglia con rosetta Lever Handle on rose	003	mm Ø45x7	con grano with grub screw	•	•	2
26 MR 007	Maniglia con rosetta Lever Handle on rose	007	mm 67x27	ovale stretta con grano oval and reduced with grub screw	•	•	2
26 MR 009	Maniglia con rosetta Lever Handle on rose	009	mm 62x32	ovale con grano oval with grub screw	•	•	1

CREMONESE / WINDOW HANDLE WITH MECHANISM



26 SG 137	Cremonese con placca Window Handle on plate	137	mm 167x40	con fori viti con gioco with holes for screws with mechanism	•	•	2
-----------	--	-----	-----------	---	---	---	---

MARTELLINA / WINDOW HANDLE WITHOUT MECHANISM



26 SE 137	Martellina con placca Window Handle on plate	137	mm 167x40	con fori viti q.7 with holes for screws with square-pin mm 7	•	•	2
-----------	---	-----	-----------	---	---	---	---

DREH KIPP / DREH KIPP



26 DK 015	Dreh Kipp con rosetta Dreh Kipp on rose	015	mm 65x31	con movimento in metallo with metal mechanism	•	•	3
26 DK C67	Dreh Kipp con rosetta Safety DK on rose	C67	mm 69x33	c/chiave e cilindro e mov. in metallo with key and cylinder and metal mec.	•	•	1

IMPUGNATURA PER MANIGLIA / LEVER HANDLE

26 IP	Solo impugnatura con foro grano M6 e foro q.8 Lever Handle only q.8 with grub screw M6			•	•	
-------	---	--	--	---	---	--

placca speciale "stretta"
plate special "reduced"

26



26 DK C67 LV



26 MP 026 LV



26 IP-LV

Per caratteristiche tecniche rosette vedi apposito capitolo soluzioni tecniche e componenti / For technical specifications rosettes see specific section technical solutions and components

A RICHIESTA / ON REQUEST:

- Mezza maniglia con placca o con rosetta (specificare se destra o sinistra) / Half lever handle on plate or on rose (to specify if right or left)
- Maniglia con rosette senza bocchette / Lever handle on rose without rose for key
- Coppie impugnatura (CM) con grano e ferro senza rosette e senza bocchette / Pair levers (CM) with grub screws and square pin without rose and without rose for key
- Cremonese e martellina con placca coprivite e movimento intercambiabile

art. **30** ELENA

materiale: Ottone
material: Solid Brass

Brass Class
100% Ottone

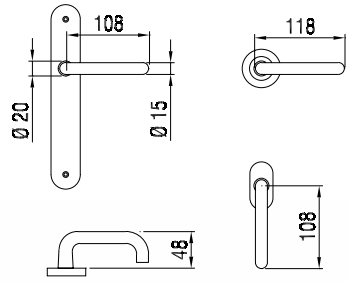

30 MR 005 OSC



30 MR 007 LV



30 MR 009 LV



30 MR 005 OC



30 MR 004 NR



30 MP 066 LV

speciale
special
25



30 DK 025 LV







30 DK 015 LV



MANIGLIA CON PLACCA / LEVER HANDLE ON PLATE

	30 MP 066	Maniglia con placca Lever Handle on plate	066 mm 240x37	con molla with spring	•	•	•	1
	30 MP 066	Maniglia con placca Lever Handle on plate	066 mm 240x37	con molla e grano with spring and grub screw	•	•	•	1
	30 PW 066	Maniglia con placca Lever Handle on plate	066 mm 240x37	con WC 503 con molla with WC turn 503 with spring	•	•	•	1
	30 PW 066	Maniglia con placca Lever Handle on plate	066 mm 240x37	con WC 503 con molla e grano with WC turn 503 with spring and grub screw	•	•	•	1
	30 PG 066	Maniglia con placca Lever Handle on plate	066 mm 240x37	con WC 512 grande con molla with WC turn 512 with spring	•	•	•	1
	30 PG 066	Maniglia con placca Lever Handle on plate	066 mm 240x37	con WC 512 grande con molla e grano with WC turn 512 with spring and grub screw	•	•	•	1

MANIGLIA CON ROSETTA / LEVER HANDLE ON ROSE

	30 MR 004	Maniglia con rosetta Lever Handle on rose	004 mm Ø45x9	con molla e grano with spring and grub screw	•	•	•	2
	30 MR 005	Maniglia con rosetta Lever Handle on rose	005 mm Ø50x8	tipo lusso con molla e grano lusso type with spring and grub screw	•	•	•	2
	30 MR 007	Maniglia con rosetta Lever Handle on rose	007 mm 67x27	ovale stretta con grano oval and reduced with grub screw	•	•	•	2
	30 MR 009	Maniglia con rosetta Lever Handle on rose	009 mm 62x32	ovale con molla e grano oval with spring and grub screw	•	•	•	1
	30 RW 004	Maniglia con rosetta Lever Handle on rose	004 mm Ø45x9	con WC 503 with WC turn 503	•	•	•	1
	30 RW 005	Maniglia con rosetta Lever Handle on rose	005 mm Ø50x8	tipo lusso con WC 503 lusso type with WC turn 503	•	•	•	1
	30 RG 004	Maniglia con rosetta Lever Handle on rose	004 mm Ø45x12	con WC 512 grande with WC turn 512	•	•	•	1
	30 RG 005	Maniglia con rosetta Lever Handle on rose	005 mm Ø50x8	tipo lusso con WC 512 grande lusso type with WC turn 512	•	•	•	1



CREMONESE / WINDOW HANDLE WITH MECHANISM

	30 SG 137	Cremonese con placca Window Handle on plate	137 mm 167x40	con fori viti con gioco with holes for screws with mechanism	•	•	•	2
---	-----------	--	---------------	---	---	---	---	---

MARTELLINA / WINDOW HANDLE WITHOUT MECHANISM

	30 SE 137	Martellina con placca Window Handle on plate	137 mm 167x40	con fori viti q.7 with holes for screws with square-pin mm 7	•	•	•	2
---	-----------	---	---------------	---	---	---	---	---

DREH KIPP / DREH KIPP

	30 DK 015	Dreh Kipp con rosetta Dreh Kipp on rose	015 mm 65x31	con movimento in metallo with metal mechanism	•	•	•	3
	30 DK 025	Dreh Kipp con rosetta Dreh Kipp on rose	025 mm 65x25	con movimento in metallo with metal mechanism	•	•	•	3
	30 DK 024	Dreh Kipp con rosetta Dreh Kipp on rose	024 mm 65x31	c/mov. in metallo e quadro autoregolante with metal mec. and adjustable square-pin	•	•	•	3
	30 DK 075	Dreh Kipp con rosetta Safety DK on rose	075 mm 64x30	con mov. securblock e pulsante di sicurezza with securblock system and push button	•	•	•	2

A RICHIESTA / ON REQUEST:

- Mezza maniglia con placca o con rosetta (specificare se destra o sinistra) / Half lever handle on plate or on rose (to specify if right or left)
- Maniglia con rosette senza bocchette / Lever handle on rose without rose for key
- Coppie impugnature (CM) con grano e ferro senza rosette e senza bocchette / Pair levers (CM) with grub screws and square pin without rose and without rose for key

art. **31** SABINA

materiale: Ottone
material: Solid Brass

Brass Class
100% Ottone

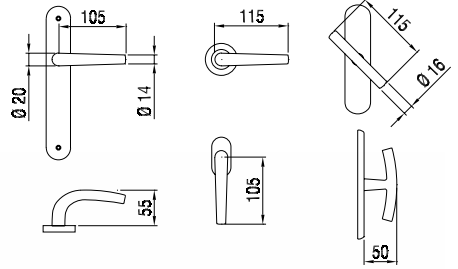

31 MR 416 LV 



31 MR 416 OSC 



31 MR 007 LV



31 MR 006 OSC



31 MR 004 OC



31 MR 004 BG



31 MP 066 LV



31 MA 137 LV
31 CR 137 LV



31 MA 036 LV
31 CR 036 LV



31 MA 007 LV



31 DK 015 LV
31 DK 024 LV



MANIGLIA CON PLACCA / LEVER HANDLE ON PLATE

	31 MP 066	Maniglia con placca Lever Handle on plate	066	mm 240x37	con molla with spring	•	•	1
	31 MP 066	Maniglia con placca Lever Handle on plate	066	mm 240x37	con molla e grano with spring and grub screw	•	•	1
	31 MP 026	Maniglia con placca Lever Handle on plate	026	mm 225x26	"stretta" con grano "reduced" with grub screw	•	•	1
	31 PW 066	Maniglia con placca Lever Handle on plate	066	mm 240x37	con WC 503 con molla with WC turn 503 with spring	•	•	1
	31 PW 066	Maniglia con placca Lever Handle on plate	066	mm 240x37	con WC 503 con molla e grano with WC turn 503 with spring and grub screw	•	•	1

MANIGLIA CON ROSETTA / LEVER HANDLE ON ROSE

	31 MR 004	Maniglia con rosetta Lever Handle on rose	004	mm Ø45x9	con molla e grano with spring and grub screw	•	•	5
	31 MR 006	Maniglia con rosetta Lever Handle on rose	006	mm Ø50x8	tipo lusso con molla e grano lusso type with spring and grub screw	•	•	2
	31 MR 007	Maniglia con rosetta Lever Handle on rose	007	mm 67x27	ovale stretta con grano oval and reduced with grub screw	•	•	5
	31 MR 009	Maniglia con rosetta Lever Handle on rose	009	mm 62x32	ovale con molla e grano oval with spring and grub screw	•	•	1
	31 MR 416	Maniglia con rosetta Lever Handle on rose	416	mm Ø45x9	con molla e grano with spring and grub screw	•	•	5
	31 RW 004	Maniglia con rosetta Lever Handle on rose	004	mm Ø45x9	con WC 503 with WC turn 503	•	•	1
	31 RW 006	Maniglia con rosetta Lever Handle on rose	006	mm Ø50x8	tipo lusso con WC 503 lusso type with WC turn 503	•	•	1

CREMONESE / WINDOW HANDLE WITH MECHANISM

	31 CR 036	Cremonese con placca Window Handle on plate	036	mm 158x36	con fori viti con gioco with holes for screws with mechanism	•	•	6
	31 CR 137*	Cremonese con placca Window Handle on plate	137	mm 167x40	con fori viti con gioco with holes for screws with mechanism	•	•	6

MARTELLINA / WINDOW HANDLE WITHOUT MECHANISM

	31 MA 036	Martellina con placca Window Handle on plate	036	mm 158x36	q.7 without mechanism with square-pin mm 7	•	•	6
	31 MA 137*	Martellina con placca Window Handle on plate	137	mm 167x40	con fori viti q.7 with holes for screws with square-pin mm 7	•	•	6
	31 MA 007	Martellina con rosetta Window Handle on rose	007	mm 67x27	q.7 without mechanism with square-pin mm 7	•	•	6

DREH KIPP / DREH KIPP

	31 DK 015	Dreh Kipp con rosetta Dreh Kipp on rose	015	mm 65x31	con movimento in metallo with metal mechanism	•	•	6
	31 DK 024	Dreh Kipp con rosetta Dreh Kipp on rose	024	mm 65x31	con movimento in metallo, preassemblato senza grano with fixed metal mechanism without grub screw	•	•	6
	31 DK 074	Dreh Kipp con rosetta Safety DK on rose	074	mm 64x30	con mov. securblock e quadro autoregolante with securblock and adjustable square-pin	•	•	2

* Placca adatta a movimenti intercambiabili - Plate suitable to interchangeable movements

A RICHIESTA / ON REQUEST:

- Mezza maniglia con placca o con rosetta (specificare se destra o sinistra) / Half lever handle on plate or on rose (to specify if right or left)
- Maniglia con rosette senza bocchette / Lever handle on rose without rose for key
- Coppie impugnature (CM) con grano e ferro senza rosette e senza bocchette / Pair levers (CM) with grub screws and square pin without rose and without rose for key
- Cremonesi e martelline con impugnatura a maniglia (segretini)
- Cremonese e martellina con placca coprivite e movimento intercambiabile

art. 31 SABINA

design: Studio Reguitti
 materiale: Impugnatura Zama
 material: Lever Zamak

TeKnoMetal
 Linea in zama

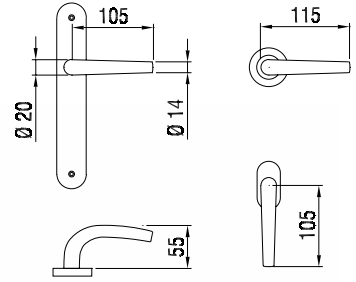

31 MR 416 ZCR 



31 MR 006 ZSC



31 MR 007 ZCR



31 MR 416 ZSC



31 MR 816 SNV



31 MR 009 ZCR



31 MP 026 ZSC



31 DK 024 PVD



31 DK 024 ZSC



MANIGLIA CON PLACCA / LEVER HANDLE ON PLATE

	31 MP 066	Maniglia con placca Lever Handle on plate	066	mm 240x37	con molla e grano with spring and grub screw	•				2
	31 MP 026	Maniglia con placca Lever Handle on plate	026	mm 225x26	"stretta" con grano reduced with grub screw	•				1

MANIGLIA CON ROSETTA / LEVER HANDLE ON ROSE

	31 MR 004	Maniglia con rosetta Lever Handle on rose	004	mm Ø45x9	con molla e grano with spring and grub screw	•	•	•	•	5
	31 MR 006	Maniglia con rosetta Lever Handle on rose	006	mm Ø50x8	tipo lusso con molla e grano luxu type with spring and grub screw	•	•		•	2
	31 MR 007	Maniglia con rosetta Lever Handle on rose	007	mm 67x27	ovale stretta con grano oval and reduced with grub screw	•				2
	31 MR 008	Maniglia con rosetta Lever Handle on rose	008	mm Ø50x8	con molla e grano with spring and grub screw	•	•			2
	31 MR 009	Maniglia con rosetta Lever Handle on rose	009	mm 62x32	ovale con molla e grano oval with spring and grub screw	•		•	•	1
	31 MR 416	Maniglia con rosetta Lever Handle on rose	416	mm Ø45x9	con molla e grano with spring and grub screw	•	•	•	•	5
	31 MR 816	Maniglia con rosetta Lever Handle on rose	816	mm Ø50x10	con molla e grano with spring and grub screw	•	•			1

DREH KIPP / DREH KIPP

	31 DK 015	Dreh Kipp con rosetta Dreh Kipp on rose	015	mm 65x31	con movimento in metallo with metal mechanism	•	•	•	•	6
	31 DK 024	Dreh Kipp con rosetta Dreh Kipp on rose	024	mm 65x31	c/mov. in metallo e quadro autoregolante with metal mec. and adjustable square-pin	•			•	6
	31 DK 074	Dreh Kipp con rosetta Safety DK on rose	074	mm 64x30	con mov. securblock e quadro autoregolante with securblock and adjustable square-pin	•			•	2
	31 DK C67	Dreh Kipp con rosetta Safety DK on rose	C67	mm 69x33	c/chiave e cilindro e mov. in metallo with key and cylinder and metal mec.	•	•		•	1



31 DK C67 ZSC



31 MR 416 PVD



31 MR 004 NR



31 MR 009 NR

Per caratteristiche tecniche rosette vedi apposito capitolo soluzioni tecniche e componenti / For technical specifications rosettes see specific section technical solutions and components

A RICHIESTA / ON REQUEST:

- Mezza maniglia con placca o con rosetta (specificare se destra o sinistra) / Half lever handle on plate or on rose (to specify if right or left)
- Maniglia con rosette senza bocchette / Lever handle on rose without rose for key
- Coppie impugnature (CM) con grano e ferro senza rosette e senza bocchette / Pair levers (CM) with grub screws and square pin without rose and without rose for key

art. 37 MONIA

materiale: Ottone
material: Solid Brass

Brass Class
100% Ottone

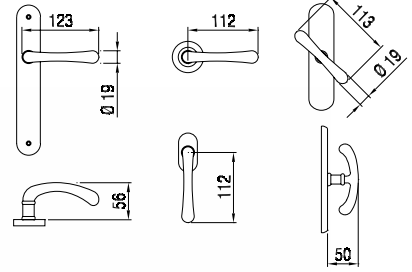

37 MR 006 LV



37 MR 416 BG



37 MR 004 BG



37 MR 007 OC



37 MR 009 LV



37 MR 916 BG



37 MR R37 LV



37 MS R46 LV
vedi capitolo "Porte d'entrata"
see chapter "Entrance Doors"



37 MP 037 LV



37 MA 137 LV
37 CR 137 LV



37 MA 007 LV







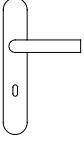
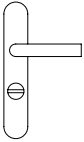

37 DK 015 LV
37 DK 024 LV



MANIGLIA CON PLACCA / LEVER HANDLE ON PLATE

	37 MP 037	Maniglia con placca Lever Handle on plate	037	mm 255x42	con molla with spring	•	•	1
	37 MP 037	Maniglia con placca Lever Handle on plate	037	mm 255x42	con molla e grano with spring and grub screw	•	•	1
	37 MP 026	Maniglia con placca Lever Handle on plate	026	mm 225x26	stretta con grano reduced with grub screw	•	•	1
	37 PW 037	Maniglia con placca Lever Handle on plate	037	mm 255x42	con WC 503 con molla with WC turn 503 with spring	•	•	1
	37 PW 037	Maniglia con placca Lever Handle on plate	037	mm 255x42	con WC 503 con molla e grano with WC turn 503 with spring and grub screw	•	•	1

MANIGLIA CON ROSETTA / LEVER HANDLE ON ROSE

	37 MR 004	Maniglia con rosetta Lever Handle on rose	004	mm Ø45x9	con molla e grano with spring and grub screw	•	•	2
	37 MR 006	Maniglia con rosetta Lever Handle on rose	006	mm Ø50x8	tipo lusso con molla e grano lusso type with spring and grub screw	•	•	2
	37 MR 007	Maniglia con rosetta Lever Handle on rose	007	mm 67x27	ovale stretta con grano oval and reduced with grub screw	•	•	2
	37 MR 009	Maniglia con rosetta Lever Handle on rose	009	mm 62x32	ovale con molla e grano oval with spring and grub screw	•	•	1
	37 MR R37	Maniglia con rosetta Lever Handle on rose	R37	mm 74x41	con molla e grano with spring and grub screw	•	•	1
	37 MR 416	Maniglia con rosetta Lever Handle on rose	416	mm Ø45x9	con molla e grano with spring and grub screw	•	•	5
	37 MR 916	Maniglia con rosetta Lever Handle on rose	916	mm 62x32	ovale con molla e grano oval with spring and grub screw	•	•	1
	37 RW 004	Maniglia con rosetta Lever Handle on rose	004	mm Ø45x9	con WC 503 with WC turn 503	•	•	1
	37 RW 006	Maniglia con rosetta Lever Handle on rose	006	mm Ø50x8	tipo lusso con WC 503 lusso type with WC turn 503	•	•	1



CREMONESE / WINDOW HANDLE WITH MECHANISM

	37 CR 137*	Cremonese con placca Window Handle on plate	137	mm 167x40	con fori viti con gioco with holes for screws with mechanism	•	•	2
---	------------	--	-----	-----------	---	---	---	---

MARTELLINA / WINDOW HANDLE WITHOUT MECHANISM

	37 MA 137*	Martellina con placca Window Handle on plate	137	mm 167x40	con fori viti q.7 without mechanism with square-pin mm 7	•	•	2
	37 MA 007	Martellina con rosetta Window Handle on rose	007	mm 67x27	q.7 without mechanism with square-pin mm 7	•	•	2

DREH KIPP / DREH KIPP

	37 DK 015	Dreh Kipp con rosetta Dreh Kipp on rose	015	mm 65x31	con movimento in metallo with metal mechanism	•	•	3
	37 DK C15	Dreh Kipp con rosetta Dreh Kipp on rose	C15	mm 102x31	con movimento con chiave with mechanism with key	•	•	2
	37 DK 024	Dreh Kipp con rosetta Dreh Kipp on rose	024	mm 65x31	c/mov. in metallo e quadro autoregolante with metal mec. and adjustable square-pin	•	•	6
	37 DK 074	Dreh Kipp con rosetta Safety DK on rose	074	mm 64x30	con mov. securblock e quadro autoregolante with securblock and adjustable square-pin	•	•	2

* Placca adatta a movimenti intercambiabili - Plate suitable to interchangeable movements

Per caratteristiche tecniche rosette vedi apposito capitolo soluzioni tecniche e componenti / For technical specifications rosettes see specific section technical solutions and components

A RICHIESTA / ON REQUEST:

- Mezza maniglia con placca o con rosetta (specificare se destra o sinistra) / Half lever handle on plate or on rose (to specify if right or left)
- Maniglia con rosette senza bocchette / Lever handle on rose without rose for key
- Coppie impugnature (CM) con grano e ferro senza rosette e senza bocchette / Pair levers (CM) with grub screws and square pin without rose and without rose for key
- Cremonesi e martelline con impugnatura a maniglia (segretini)
- Cremonese e martellina con placca coprivite e movimento intercambiabile

art. **40** GINEVRA

materiale: Ottone
material: Solid Brass

Brass Class
100% Ottone

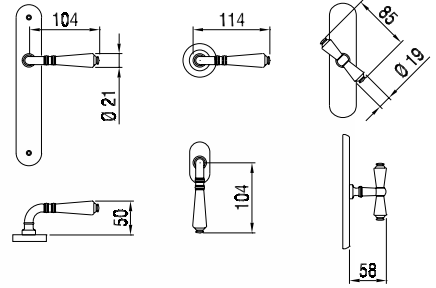

40 MR 202 AGV

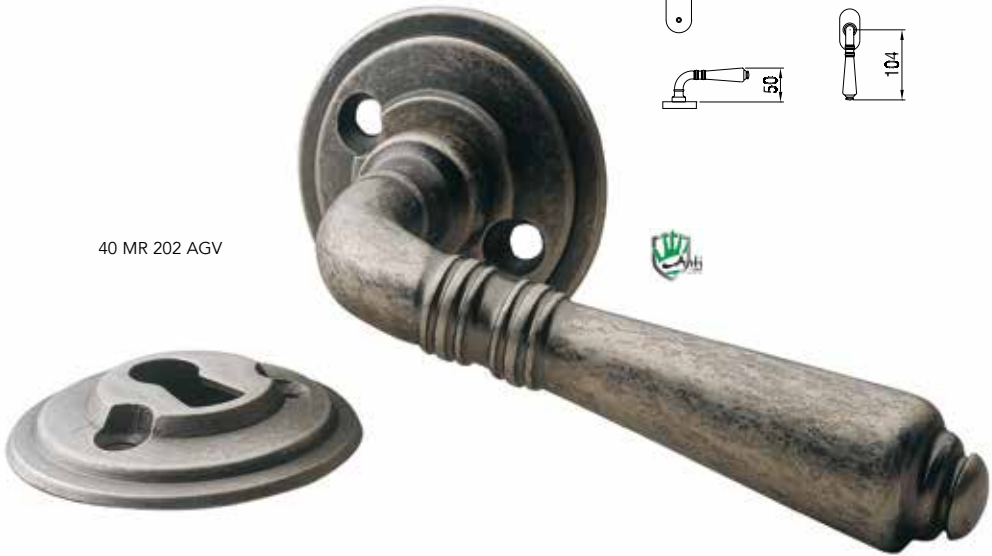

40 MR 009 AN



40 MR 007 AGV



40 MR R40 AN



40 MR 006 LV



40 MR 004 BG



40 MR 202 NC



40 MP 040 LV



40 MA 040 LV
40 CR 040 LV



40 MA 007 LV

40 DK 015 LV
40 DK 024 LV

VERSIONI / VERSIONS



Finiture
Finishes

						LV BG	AN	AGV	NC	
MANIGLIA CON PLACCA / LEVER HANDLE ON PLATE										
	40 MP 040	Maniglia con placca Lever Handle on plate	040	mm 244x40	con molla with spring	•	•	•	•	3
	40 MP 040	Maniglia con placca Lever Handle on plate	040	mm 244x40	con molla e grano with spring and grub screw	•	•	•	•	3
	40 MP 026	Maniglia con placca Lever Handle on plate	026	mm 225x26	stretta con grano reduced with grub screw	•	•	•		5
MANIGLIA CON ROSETTA / LEVER HANDLE ON ROSE										
	40 MR 003	Maniglia con rosetta Lever Handle on rose	003	mm Ø45x7	con molla e grano with spring and grub screw			•		5
	40 MR 004	Maniglia con rosetta Lever Handle on rose	004	mm Ø45x9	con molla e grano with spring and grub screw	•	•			5
	40 MR 006	Maniglia con rosetta Lever Handle on rose	006	mm Ø50x8	tipo lusso con molla e grano lusso type with spring and grub screw	•	•	•		2
	40 MR 007	Maniglia con rosetta Lever Handle on rose	007	mm 67x27	ovale stretta con grano oval and reduced with grub screw	•	•	•		5
	40 MR 009	Maniglia con rosetta Lever Handle on rose	009	mm 62x32	ovale con grano oval with grub screw	•	•	•		1
	40 MR 202	Maniglia con rosetta Lever Handle on rose	202	mm Ø52x9	con bordo con grano with edge with grub screw	•	•	•	•	5
	40 MR R40	Maniglia con rosetta Lever Handle on rose	R40	mm Ø45x7	con fori viti a vista con grano with holes for screws with grub screw	•	•			5
		40 MR 416	Maniglia con rosetta Lever Handle on rose	416	mm Ø45x9	con molla e grano with spring and grub screw	•	•	•	
CREMONESE / WINDOW HANDLE WITH MECHANISM										
	40 CR 040*	Cremonese con placca Window Handle on plate	040	mm 174x37	con gioco with mechanism	•	•	•	•	6
	40 CR 063	Cremonese con placca Window Handle on plate	063	mm 143x37	con gioco M.P. per aste esterne G.M.P for outside rods with mechanism	•	•	•	•	6
MARTELLINA / WINDOW HANDLE WITHOUT MECHANISM										
	40 MA 040*	Martellina con placca Window Handle on plate	040	mm 174x37	q.7 without mechanism with square-pin mm 7	•	•	•	•	6
	40 MA 007	Martellina con rosetta Window Handle on rose	007	mm 67x27	q.7 without mechanism with square-pin mm 7	•	•	•		6
DREH KIPP / DREH KIPP										
	40 DK 015	Dreh Kipp con rosetta Dreh Kipp on rose	015	mm 65x31	con movimento in metallo with metal mechanism	•	•	•	•	6
	40 DK 024	Dreh Kipp con rosetta Dreh Kipp on rose	024	mm 65x31	c.mov. in metallo e quadro autoregolante with metal mec. and adjustable square-pin	•	•	•		6
	40 DK C67	Dreh Kipp con rosetta Safety DK on rose	C67	mm 69x33	c/chiave e cilindro e movimento in metallo with key and cylinder and metal mechanism	•	•	•		1

* Placca adatta a movimenti intercambiabili
Plate suitable to interchangeable movements



40 DK C67 AN



40 MP 026 AN

Per caratteristiche tecniche rosette vedi apposito capitolo soluzioni tecniche e componenti / For technical specifications rosettes see specific section technical solutions and components

A RICHIESTA / ON REQUEST:

- Mezza maniglia con placca o con rosetta (specificare se destra o sinistra) / Half lever handle on plate or on rose (to specify if right or left)
- Maniglia con rosette senza bocchette / Lever handle on rose without rose for key
- Coppie impugnature (CM) con grano e ferro senza rosette e senza bocchette / Pair levers (CM) with grub screws and square pin without rose and without rose for key
- Cremonesi e martelline con impugnatura a maniglia (segretini)
- Cremonese e martellina con placca coprivite e movimento intercambiabile

art. 43 RITA

materiale: Ottone
material: Solid Brass

Brass Class
100% Ottone

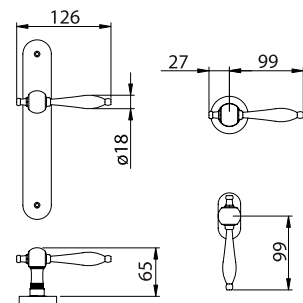

43 MP 040 AGV



43 MP 039 AGV



43 MR 007 LV



43 MR 202 AGV



43 DK 015 AGV

VERSIONI / VERSIONS



MANIGLIA CON PLACCA / LEVER HANDLE ON PLATE

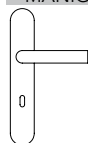

43 MP 039 Maniglia con placca 039 mm 255x50 con grano
Lever Handle on plate with grub screw

43 MP 040 Maniglia con placca 040 mm 244x40 con grano
Lever Handle on plate with grub screw

43 MP 026 Maniglia con placca 026 mm 225x26 stretta con grano
Lever Handle on plate reduced with grub screw

MANIGLIA CON ROSETTA / LEVER HANDLE ON ROSE

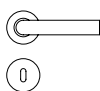

43 MR 202 Maniglia con rosetta 202 mm Ø52x9 con bordo con grano
Lever Handle on rose with edge with grub screw

43 MR 007 Maniglia con rosetta 007 mm 67x27 ovale stretta con grano
Lever Handle on rose oval and reduced with grub screw

CREMONESE / WINDOW HANDLE WITH MECHANISM



43 CR 040 Cremonese con placca 040 mm 174x37 con gioco
Window Handle on plate with mechanism

MARTELLINA / WINDOW HANDLE WITHOUT MECHANISM



43 MA 040 Martellina con placca 040 mm 174x37 q. 7
Window Handle on plate without mechanism with square-pin mm 7

DREH KIPP / DREH KIPP



43 DK 015 Dreh Kipp con rosetta 015 mm 65x31 con movimento in metallo
Dreh Kipp on rose with metal mechanism

	LV	AGV	
43 MP 039	•	•	1
43 MP 040	•	•	1
43 MP 026	•	•	1
43 MR 202	•	•	2
43 MR 007	•	•	2
43 CR 040	•	•	2
43 MA 040	•	•	2
43 DK 015	•	•	3

A RICHIESTA / ON REQUEST:

- Mezza maniglia con placca o con rosetta (specificare se destra o sinistra) / Half lever handle on plate or on rose (to specify if right or left)
- Maniglia con rosette senza bocchette / Lever handle on rose without rose for key
- Coppie impugnature (CM) con grano e ferro senza rosette e senza bocchette / Pair levers (CM) with grub screws and square pin without rose and without rose for key
- Cremonesi e martelline con impugnatura a maniglia (segretini)
- Cremonese e martellina con placca coprivite e movimento intercambiabile

art. 46 MARY

materiale: Ottone
material: Solid Brass

Brass Class
100% Ottone



46 MR 202 AGV

Finiture
Finishes

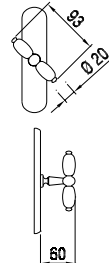
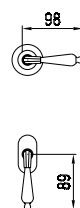
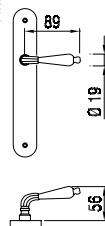

46 MP 040 LV



46 MA 040 LV
46 CR 040 LV



46 DK 015 LV



46 MR 202 AN



46 MR T33 LV

VERSIONI / VERSIONS



Finiture
Finishes

MANIGLIA CON PLACCA / LEVER HANDLE ON PLATE

	LV	AN	AGV	
46 MP 040 Maniglia con placca / Lever Handle on plate 040 mm 244x40 con grano / with grub screw	•	•	•	1
46 MP 026 Maniglia con placca / Lever Handle on plate 026 mm 225x26 stretta con grano / reduced with grub screw	•	•	•	1

MANIGLIA CON ROSETTA / LEVER HANDLE ON ROSE

46 MR 202 Maniglia con rosetta / Lever Handle on rose 202 mm Ø52x9 con bordo con grano / with edge with grub screw	•	•	•	2
46 MR 007 Maniglia con rosetta / Lever Handle on rose 007 mm 67x27 ovale stretta con grano / oval and reduced with grub screw	•	•	•	2
46 MR T33 Maniglia con rosetta / Lever Handle on rose T33 mm Ø37x5 con bordo con grano / with edge with grub screw	•	•	•	2

CREMONESE / WINDOW HANDLE WITH MECHANISM

46 CR 040 Cremonese con placca / Window Handle on plate 040 mm 174x37 con gioco / with mechanism	•	•	•	2
--	---	---	---	---

MARTELLINA / WINDOW HANDLE WITHOUT MECHANISM

46 MA 040 Martellina con placca / Window Handle on plate 040 mm 174x37 q. 7 / without mechanism with square-pin mm 7	•	•	•	2
46 MA 007 Martellina con rosetta / Window Handle on rose 007 mm 67x27 q. 7 / without mechanism with square-pin mm 7	•	•	•	6

DREH KIPP / DREH KIPP

46 DK 015 Dreh Kipp con rosetta / Dreh Kipp on rose 015 mm 65x31 con movimento in metallo / with metal mechanism	•	•	•	6
--	---	---	---	---

A RICHIESTA / ON REQUEST:

- Mezza maniglia con placca o con rosetta (specificare se destra o sinistra) / Half lever handle on plate or on rose (to specify if right or left)
- Maniglia con rosette senza bocchette / Lever handle on rose without rose for key
- Coppie impugnature (CM) con grano e ferro senza rosette e senza bocchette / Pair levers (CM) with grub screws and square pin without rose and without rose for key
- Cremonesi e martelline con impugnatura a maniglia (segretini)
- Cremonese e martellina con placca coprivite e movimento intercambiabile

art. 49 TOSCA

design: Studio Reguitti
 materiale: Ottone
 material: Solid Brass

Brass Class
 100% Ottone

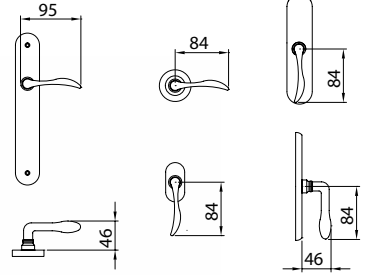

49 MR R40 VBN



49 MR R40 LV



49 MR 202 LR



49 MR R40 AGV



49 MR 406 RX



49 MR 007 AN



49 MP 166 VBN



49 MA 040 VBN
 49 CR 040 VBN

destra/right





49 DK 015 VBN



49 TK 015 VBN

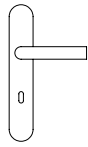

Finiture
Finishes

						LV LR	AN	AGV	VBN	RX	
MANIGLIA CON PLACCA / LEVER HANDLE ON PLATE											
	49 MP 166	Maniglia con placca Lever Handle on plate	166	mm 242x33	con grano with grub screw	•	•	•	•		1
	49 MP 040	Maniglia con placca Lever Handle on plate	040	mm 244x40	con grano with grub screw	•	•	•	•	•	1
	49 MP 026	Maniglia con placca Lever Handle on plate	026	mm 225x26	stretta con grano reduced with grub screw	•	•	•	•	•	1
MANIGLIA CON ROSETTA / LEVER HANDLE ON ROSE											
	49 MR R40	Maniglia con rosetta Lever Handle on rose	R40	mm Ø45x7	con fori viti a vista con grano with holes for screws w/grub screw	•	•	•	•		2
	49 MR 202	Maniglia con rosetta Lever Handle on rose	202	mm Ø52x9	con bordo con grano with edge with grub screw	•	•	•	•	•	2
	49 MR 006	Maniglia con rosetta Lever Handle on rose	006	mm Ø50x8	tipo lusso con grano luxu type with grub screw	•	•	•	•	•	2
	49 MR 007	Maniglia con rosetta Lever Handle on rose	007	mm 67x27	ovale stretta con grano oval and reduced with grub screw	•	•	•	•	•	2
	49 MR 406	Maniglia con rosetta Lever Handle on rose	406	mm Ø45x9	con grano with grub screw					•	1
CREMONESE / WINDOW HANDLE WITH MECHANISM											
	49 CR 040*	Cremonese con placca Window Handle on plate	040	mm 174x37	con gioco with mechanism	•	•	•	•	•	2
MARTELLINA / WINDOW HANDLE WITHOUT MECHANISM											
	49 MA 040*	Martellina con placca Window Handle on plate	040	mm 174x37	q.7 without mechanism w/square-pin mm 7	•	•	•	•	•	2
	49 MA 007	Martellina con rosetta Window Handle on rose	007	mm 67x27	q.7 without mechanism w/square-pin mm 7	•	•	•	•	•	2
DREH KIPP / DREH KIPP											
	49 DK 015	Dreh Kipp destro con rosetta Dreh Kipp (right) on rose	015	mm 65x31	con movimento in metallo with metal mechanism	•	•	•	•	•	3
	49 TK 015	Dreh Kipp con rosetta Dreh Kipp on rose	015	mm 65x31	con impugnatura martellina a "T" shape "T"	•	•	•	•	•	3

* Placca adatta a movimenti intercambiabili
Plate suitable to interchangeable movements



49 MP 026 AN



49 MA 007 VBN

Per caratteristiche tecniche rosette vedi apposito capitolo soluzioni tecniche e componenti / For technical specifications rosettes see specific section technical solutions and components

A RICHIESTA / ON REQUEST:

- Mezza maniglia con placca o con rosetta (specificare se destra o sinistra) / Half lever handle on plate or on rose (to specify if right or left)
- Maniglia con rosette senza bocchette / Lever handle on rose without rose for key
- Coppie impugnature (CM) con grano e ferro senza rosette e senza bocchette / Pair levers (CM) with grub screws and square pin without rose and without rose for key

art. 61 NADIA

materiale: Ottone
material: Solid Brass

Brass Class
100% Ottone



61 MR 005 BG

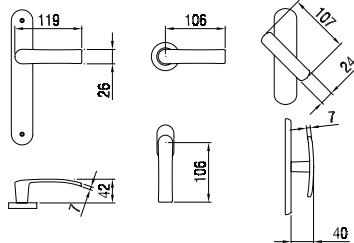

61 MP 066 LV



61 MA 137 LV
61 CR 137 LV



61 DK 015 LV

VERSIONI / VERSIONS



Finiture
Finishes

			LV	BG	
MANIGLIA CON PLACCA / LEVER HANDLE ON PLATE					
61 MP 066	Maniglia con placca Lever Handle on plate	066 mm 240x37 con molla e grano with spring and grub screw	•		1
MANIGLIA CON ROSETTA / LEVER HANDLE ON ROSE					
61 MR 005	Maniglia con rosetta Lever Handle on rose	005 mm Ø50x8 tipo lusso con molla e grano lusso type with spring and grub screw	•		2
CREMONESE / WINDOW HANDLE WITH MECHANISM					
61 CR 137*	Cremonese con placca Window Handle on plate	137 mm 167x40 con fori viti con gioco with holes for screws with mechanism	•		2
MARTELLINA / WINDOW HANDLE WITHOUT MECHANISM					
61 MA 137*	Martellina con placca Window Handle on plate	137 mm 167x40 con fori viti q.7 with holes for screws with square-pin mm 7	•		2
DREH KIPP / DREH KIPP					
61 DK 015	Dreh Kipp con rosetta Dreh Kipp on rose	015 mm 65x31 con movimento in metallo with metal mechanism	•		3

* Placca adatta a movimenti intercambiabili
Plate suitable to interchangeable movements

A RICHIESTA / ON REQUEST:

- Mezza maniglia con placca o con rosetta (specificare se destra o sinistra) / Half lever handle on plate or on rose (to specify if right or left)
- Maniglia con rosette senza bocchette / Lever handle on rose without rose for key
- Coppie impugnature (CM) con grano e ferro senza rosette e senza bocchette / Pair levers (CM) with grub screws and square pin without rose and without rose for key

art. 63 OLIVIA

materiale: Ottone
material: Solid Brass

Brass Class
100% Ottone



63 MP 066 LV



63 MP 248 LV



63 MR 006 LV



63 DK 015 LV



63 DK C67 LV



63 MR 416 OC



63 MR 009 OSC

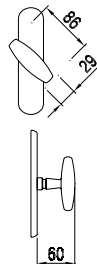
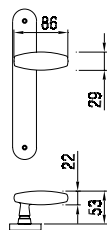

VERSIONI / VERSIONS



Finiture
Finishes

	LV	BG	OSC OC					
MANIGLIA CON PLACCA / LEVER HANDLE ON PLATE								
	63 MP 066	Maniglia con placca Lever Handle on plate	066 mm 240x37	con molla e grano with spring and grub screw	•	•	•	1
	63 MP 248	Maniglia con placca Lever Handle on plate	248 mm 248x50	con molla e grano with spring and grub screw	•	•	•	1
MANIGLIA CON ROSETTA / LEVER HANDLE ON ROSE								
	63 MR 006	Maniglia con rosetta Lever Handle on rose	006 mm Ø50x8	tipo lusso con molla e grano luxu type with spring and grub screw	•	•	•	2
	63 MR 009	Maniglia con rosetta Lever Handle on rose	009 mm 62x32	ovale con molla e grano oval with spring and grub screw	•	•	•	1
	63 MR 416	Maniglia con rosetta Lever Handle on rose	416 mm Ø45x9	con molla e grano with spring and grub screw	•	•	•	1
MARTELLINA / WINDOW HANDLE WITHOUT MECHANISM								
	63 SE 137*	Martellina con placca Window Handle on plate	137 mm 167x40	con fori viti q.7 with holes for screw with square-pin mm 7	•	•	•	2
CREMONESE / WINDOW HANDLE WITH MECHANISM								
	63 SG 137*	Cremonese con placca Window Handle on plate	137 mm 167x40	con fori con gioco with holes for screws with mechanism	•	•	•	2
	63 SG 063	Cremonese con placca Window Handle on plate	063 mm 143x37	con fori con gioco M.P. per aste esterne G. M.P. for outside rods with mechanism	•	•	•	2
DREH KIPP / DREH KIPP								
	63 DK 015	Dreh Kipp con rosetta Dreh Kipp on rose	015 mm 65x31	con movimento in metallo with metal mechanism	•	•	•	3
	63 DK C67	Dreh Kipp con rosetta Safety DK on rose	C67 mm 69x33	c/chave e cilindro e movimento in metallo with key and cylinder and metal mechanism	•	•	•	1

* Placca adatta a movimenti intercambiabili
Plate suitable to interchangeable movements

A RICHIESTA / ON REQUEST:

- Mezza maniglia con placca o con rosetta (specificare se destra o sinistra) / Half lever handle on plate or on rose (to specify if right or left)
- Maniglia con rosette senza bocchette / Lever handle on rose without rose for key
- Coppie impugnature (CM) con grano e ferro senza rosette e senza bocchette / Pair levers (CM) with grub screws and square pin without rose and without rose for key

art. **66** MOIRA

materiale: Ottone
material: Solid Brass

Brass Class
100% Ottone

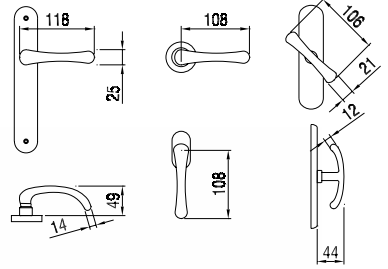

66 MR 006 LV



66 MR 007 LV



66 MR 006 OSC



66 MR 004 OC



66 MR 004 BG



66 DK 015 LV
66 DK 024 LV



66 MP 066 LV



66 MA 137 LV
66 CR 137 LV



66 MA 007 LV



					LV	BG	OSC OC	
MANIGLIA CON PLACCA / LEVER HANDLE ON PLATE								
	66 MP 066	Maniglia con placca Lever Handle on plate	066	mm 240x37	con molla with spring	•	•	1
	66 MP 066	Maniglia con placca Lever Handle on plate	066	mm 240x37	con molla e grano with spring and grub screw	•	•	1
	66 MP 026	Maniglia con placca Lever Handle on plate	026	mm 225x26	stretta con grano reduced with grub screw	•	•	1
	66 PW 066	Maniglia con placca Lever Handle on plate	066	mm 240x37	con WC 503 con molla with WC turn 503 with spring	•	•	1
	66 PW 066	Maniglia con placca Lever Handle on plate	066	mm 240x37	con WC 503 con molla e grano with WC turn 503 with spring and grub screw	•	•	1
	66 PG 066	Maniglia con placca Lever Handle on plate	066	mm 240x37	con WC 512 grande con molla with WC turn 512 with spring	•	•	1
	66 PG 066	Maniglia con placca Lever Handle on plate	066	mm 240x37	con WC 512 grande con molla e grano with WC turn 512 with spring and grub screw	•	•	1
MANIGLIA CON ROSETTA / LEVER HANDLE ON ROSE								
	66 MR 004	Maniglia con rosetta Lever Handle on rose	004	mm Ø45x9	con molla e grano with spring and grub screw	•	•	2
	66 MR 006	Maniglia con rosetta Lever Handle on rose	006	mm Ø50x8	tipo lusso con molla e grano luxu type with spring and grub screw	•	•	2
	66 MR 007	Maniglia con rosetta Lever Handle on rose	007	mm 67x27	ovale stretta con grano oval and reduced with grub screw	•	•	2
	66 MR 009	Maniglia con rosetta Lever Handle on rose	009	mm 62x32	ovale con molla e grano oval with spring and grub screw	•	•	1
	66 RW 004	Maniglia con rosetta Lever Handle on rose	004	mm Ø45x9	con WC 503 with WC turn 503	•	•	1
	66 RW 006	Maniglia con rosetta Lever Handle on rose	006	mm Ø50x8	tipo lusso con WC 503 luxu type with WC turn 503	•	•	1
	66 RG 004	Maniglia con rosetta Lever Handle on rose	004	mm Ø45x12	con WC 512 grande with WC turn 512	•	•	1
	66 RG 006	Maniglia con rosetta Lever Handle on rose	006	mm Ø50x8	tipo lusso con WC 512 grande luxu type with WC turn 512	•	•	1
CREMONESE / WINDOW HANDLE WITH MECHANISM								
	66 CR 137*	Cremonese con placca Window Handle on plate	137	mm 167x40	con fori viti con gioco with holes for screws with mechanism	•	•	2
MARTELLINA / WINDOW HANDLE WITHOUT MECHANISM								
	66 MA 137*	Martellina con placca Window Handle on plate	137	mm 167x40	con fori viti q.7 without mechanism with square-pin mm 7	•	•	2
	66 MA 007	Martellina con rosetta Window Handle on rose	007	mm 67x27	q.7 without mechanism with square-pin mm 7	•	•	2
DREH KIPP / DREH KIPP								
	66 DK 015	Dreh Kipp con rosetta Dreh Kipp on rose	015	mm 65x31	con movimento in metallo with metal mechanism	•	•	3
	66 DK 024	Dreh Kipp con rosetta Safety DK on rose	024	mm 65x31	con movimento in metallo e q. autoregolante with metal mec. and adjustable square pin	•	•	3
	66 DK 075	Dreh Kipp con rosetta Safety DK on rose	075	mm 64x30	con mov. securblock e pulsante di sicurezza with securblock system and push button	•	•	2

* Placca adatta a movimenti intercambiabili
Plate suitable to interchangeable movements

Per caratteristiche tecniche rosette vedi apposito capitolo soluzioni tecniche e componenti / For technical specifications rosettes see specific section technical solutions and components

A RICHIESTA / ON REQUEST:

- Mezza maniglia con placca o con rosetta (specificare se destra o sinistra) / Half lever handle on plate or on rose (to specify if right or left)
- Maniglia con rosette senza bocchette / Lever handle on rose without rose for key
- Coppie impugnature (CM) con grano e ferro senza rosette e senza bocchette / Pair levers (CM) with grub screws and square pin without rose and without rose for key
- Cremonesi e martelline con impugnatura a maniglia (segretini)
- Cremonese e martellina con placca coprivite e movimento intercambiabile

art. **67** PISA

design: Studio Reguitti
 materiale: Ottone
 material: Solid Brass

Brass Class
 100% Ottone

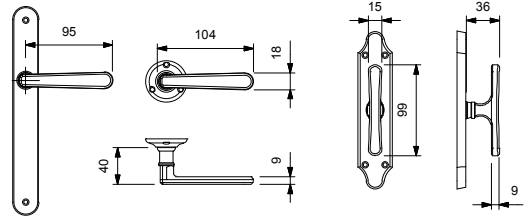

067 MR T36 - LR



067 MR 916 - LV



T67 MA 007 - LV



067 MP 026 - VBN



067 MR 007 - AGV



067 CR 040 - AGV
 067 MA 040 - AGV



067 MR R40 - AN



067 DK 015 - VBN



067 TK 015 - AN



067 MR 406 - VBN



MANIGLIA CON PLACCA / LEVER HANDLE ON PLATE					
			€	€	€

	067 MP 026	Maniglia con placca Lever handle on plate	026 mm 225x26 "stretta" "reduced"	•	•	•	•	•	•	1
	067 MP 166	Maniglia con placca Lever handle on plate	166 mm 242x33	•	•	•	•	•	•	1

MANIGLIA CON ROSETTA / LEVER HANDLE ON ROSE					
			€	€	€

	067 MR 007	Maniglia con rosetta Lever handle on rose	007 mm 67x27 ovale stretta oval and reduced	•	•	•	•	•	•	2
	067 MR 202	Maniglia con rosetta Lever handle on rose	202 mm Ø52x9 con bordo with edge	•	•	•	•	•	•	2
	067 MR 406	Maniglia con rosetta Lever handle on rose	406 mm Ø45x9	•	•	•	•	•	•	1
	067 MR 916	Maniglia con rosetta Lever handle on rose	916 mm 62x32 ovale con molla oval with spring	•	•	•	•	•	•	1
	067 MR R40	Maniglia con rosetta Lever handle on rose	R40 mm Ø45x7 con fori viti a vista with holes for screws	•	•	•	•	•	•	2
	067 MR T36	Maniglia con rosetta Lever handle on rose	T36 mm Ø45x9 con bordo with edge	•	•	•	•	•	•	2

MARTELLINA / WINDOW HANDLE WITHOUT MECHANISM					
			€	€	€

	067 MA 007	Martellina su rosetta Martellina on rose	007 mm 67x27 q.7 with square-pin mm 7	•	•	•	•	•	•	2
	067 MA 040*	Martellina su placca Martellina on plate	040 mm 174x37 q.7 with square-pin mm 7	•	•	•	•	•	•	2
	T67 MA 007	Martellina su rosetta Martellina on rose	007 mm 67x27 q.7 with square-pin mm 7	•	•	•	•	•	•	2

CREMONESE / WINDOW HANDLE WITH MECHANISM					
			€	€	€

	067 CR 040*	Cremonese con placca Cremon on plate	040 mm 174x37 con gioco with mechanism	•	•	•	•	•	•	2
--	-------------	---	--	---	---	---	---	---	---	---

DREH KIPP / DREH KIPP					
			€	€	€

	067 DK 015	Dreh kipp con rosetta Dreh Kipp on rose	015 mm 65x31 con movimento in metallo with metal mechanism	•	•	•	•	•	•	3
--	------------	--	--	---	---	---	---	---	---	---

DREH KIPP TK / TK DREH KIPP					
			€	€	€

	067 TK 015	Dreh kipp con rosetta Dreh Kipp on rose	015 mm 65x31 con impugnatura martellina a "T" "T" shape	•	•	•	•	•	•	3
--	------------	--	---	---	---	---	---	---	---	---

Per caratteristiche tecniche rosette vedi apposito capitolo soluzioni tecniche e componenti / For technical specifications rosettes see specific section technical solutions and components

A RICHIESTA / ON REQUEST:

- Mezza maniglia con placca o con rosetta (specificare se destra o sinistra) / Half lever handle on plate or on rose (to specify if right or left)
- Maniglia con rosette senza bocchette / Lever handle on rose without rose for key
- Coppie impugnature (CM) con grano e ferro senza rosette e senza bocchette / Pair levers (CM) with grub screws and square pin without rose and without rose for key

art. **70** GRAZIA

design: Studio Reguitti
 materiale: Ottone
 material: Solid Brass

Brass Class
 100% Ottone

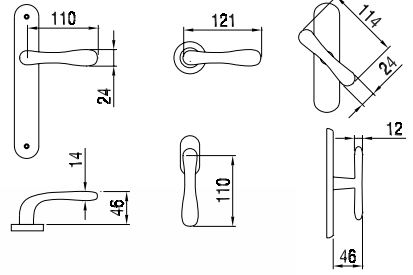

70 MR 382 LS



70 MR 009 OSC



70 MR 416 BG



70 MR 006 LV



70 MR 382 OS



70 MR 006 OC



70 MR 008 OSC



70 DK 015 LV



70 MP 248 LV





70 MP 037 LV





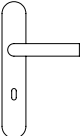

70 MA 137 LV
 70 CR 137 LV

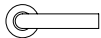

MANIGLIA CON PLACCA / LEVER HANDLE ON PLATE

	70 MP 037	Maniglia con placca Lever Handle on plate	037	mm 255x42	con molla e grano with spring and grub screw	•	•		1
	70 MP 026	Maniglia con placca Lever Handle on plate	026	mm 225x26	stretta con grano reduced with grub screw	•	•		1
	70 MP 248	Maniglia con placca Lever Handle on plate	248	mm 248x50	con molla e grano with spring and grub screw	•	•		1
	70 PW 037	Maniglia con placca Lever Handle on plate	037	mm 255x42	con WC 503 con molla e grano with WC turn 503 with spring and grub screw	•	•		1
	70 PG 037	Maniglia con placca Lever Handle on plate	037	mm 255x42	con WC 512 grande con molla e grano with WC turn 512 with spring and grub screw	•	•		1

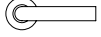
MANIGLIA CON ROSETTA / LEVER HANDLE ON ROSE

	70 MR 004	Maniglia con rosetta Lever Handle on rose	004	mm Ø45x9	con molla e grano with spring and grub screw	•	•		2
	70 MR 006	Maniglia con rosetta Lever Handle on rose	006	mm Ø50x8	tipo lusso con molla e grano lusso type with spring and grub screw	•	•	•	2
	70 MR 007	Maniglia con rosetta Lever Handle on rose	007	mm 67x27	ovale stretta con grano oval and reduced with grub screw	•	•		2
	70 MR 008	Maniglia con rosetta Lever Handle on rose	008	mm Ø50x8	con molla e grano with spring and grub screw	•	•		2
	70 MR 009	Maniglia con rosetta Lever Handle on rose	009	mm 62x32	ovale con molla e grano oval with spring and grub screw	•	•		1
	70 MR 382	Maniglia con rosetta Lever Handle on rose	382	mm Ø50x8	profilo a campana con molla e grano original profile with spring and grub screw	•	•	•	2
	70 MR 416	Maniglia con rosetta Lever Handle on rose	416	mm Ø45x9	con molla e grano with spring and grub screw	•	•		1
	70 RW 004	Maniglia con rosetta Lever Handle on rose	004	mm Ø45x9	con WC 503 with WC turn 503	•	•		1
	70 RW 006	Maniglia con rosetta Lever Handle on rose	006	mm Ø50x8	tipo lusso con WC 503 lusso type with WC turn 503	•	•	•	1
	70 RG 004	Maniglia con rosetta Lever Handle on rose	004	mm Ø45x12	con WC 512 grande with WC turn 512	•	•		1
	70 RG 006	Maniglia con rosetta Lever Handle on rose	006	mm Ø50x8	lusso con WC 512 grande lusso type with WC turn 512	•	•	•	1

CREMONESE / WINDOW HANDLE WITH MECHANISM

	70 CR 137*	Cremonese con placca Window Handle on plate	137	mm 167x40	con fori viti con gioco with holes for screws with mechanism	•	•		2
	70 CR 070*	Cremonese con placca Window Handle on plate	070	mm 189x36	coprivite con gioco with cover-screw plate with mechanism	•	•		2

MARTELLINA / WINDOW HANDLE WITHOUT MECHANISM

	70 MA 137*	Martellina con placca Window Handle on plate	137	mm 167x40	con fori viti q. 7 with holes for screws with square-pin mm 7	•	•		2
	70 MA 070*	Martellina con placca Window Handle on plate	070	mm 189x36	coprivite q. 7 with cover-screw plate with square-pin mm 7	•	•		2
	70 MA 007	Martellina con rosetta Window Handle on rose	007	mm 67x27	q. 7 without mechanism with square-pin mm 7	•	•		2

DREH KIPP / DREH KIPP

	70 DK 015	Dreh Kipp con rosetta Dreh Kipp on rose	015	mm 65x31	con movimento in metallo with metal mechanism	•	•		3
	70 DK C15	Dreh Kipp con rosetta Dreh Kipp on rose	C15	mm 102x31	con movimento con chiave with metal mechanism with key	•	•		2

* Placca adatta a movimenti intercambiabil. / Plate suitable to interchangeable movements

A RICHIESTA / ON REQUEST:

- Mezza maniglia con placca o con rosetta (specificare se destra o sinistra) / Half lever handle on plate or on rose (to specify if right or left)
- Maniglia con rosette senza bocchette / Lever handle on rose without rose for key
- Coppie impugnature (CM) con grano e ferro senza rosette e senza bocchette / Pair levers (CM) with grub screws and square pin without rose and without rose for key
- Cremonesi e martelline con impugnatura a maniglia (segretini)

art. **73** BALTIC

materiale: Ottone
material: Solid Brass

Brass Class
100% Ottone

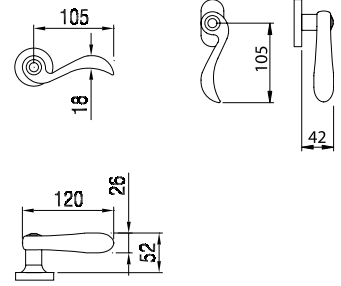

73 MR 382 OC



73 MR 382 AN



73 MR 382 AGV



73 MR 382 OS



73 MR 382 OSC



73 MR 382 BG

destro/right



73 DK 015 OC



73 MR 311 AGV



73 MR 311 AN



VERSIONI / VERSIONS



Finiture
Finishes

OS LV	LS BG	OC/LV OSC OC	AN	AGV	PVD	

MANIGLIA CON ROSETTA / LEVER HANDLE ON ROSE

	73 MR 382	Maniglia con rosetta Lever Handle on rose	382 mm Ø50x8	profilo a campana con molla e grano original profile with spring and grub screw	•	•	•	•	•	•	1
	73 MR 311	Maniglia con rosetta Lever Handle on rose	311 mm Ø50x8	profilo a campana con molla e grano original profile with spring and grub screw	•	•	•	•	•	•	1

DREH KIPP / DREH KIPP



73 DK 015	Dreh Kipp destro con rosetta Dreh Kipp (right) on rose	015 mm 65x31	con movimento in metallo with metal mechanism	•	•	•	•	•	•	•	3
-----------	---	--------------	--	---	---	---	---	---	---	---	---



73 MR 382 PVD



73 MR 382 OSC

Per caratteristiche tecniche rosette vedi apposito capitolo soluzioni tecniche e componenti / For technical specifications rosettes see specific section technical solutions and components

A RICHIESTA / ON REQUEST:

- Mezza maniglia con placca o con rosetta (specificare se destra o sinistra) / Half lever handle on plate or on rose (to specify if right or left)
- Maniglia con rosette senza bocchette / Lever handle on rose without rose for key
- Coppie impugnature (CM) con grano e ferro senza rosette e senza bocchette / Pair levers (CM) with grub screws and square pin without rose and without rose for key

art. 79 CHRIS

materiale: Ottone
material: Solid Brass

Brass Class
100% Ottone



79 MR 416 OSC

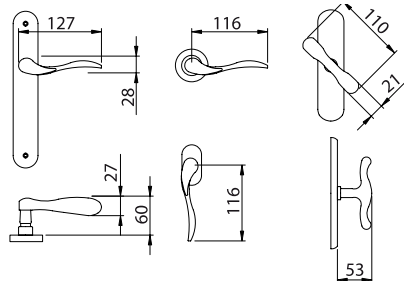

79 MR 416 OC



79 MR 005 OSC



79 MR 009 OSC



79 MA 137 LV
79 CR 137 LV



79 MP 039 LV

destra/right



79 DK C67 OSC

destra/right



79 DK 015 OSC

VERSIONI / VERSIONS



Finishes
Finiture

MANIGLIA CON PLACCA / LEVER HANDLE ON PLATE

					LV	OC OSC	
	79 MP 039	Maniglia con placca Lever Handle on plate	039 mm 255x50	con molla e grano with spring and grub screw	•		1
	79 MP 188	Maniglia con placca Lever Handle on plate	188 mm 255x42	con molla e grano with spring and grub screw	•	•	1
	79 MP 248	Maniglia con placca Lever Handle on plate	248 mm 248x50	con molla e grano with spring and grub screw	•	•	1

MANIGLIA CON ROSETTA / LEVER HANDLE ON ROSE

	79 MR 005	Maniglia con rosetta Lever Handle on rose	005 mm Ø50x8	tipo lusso con molla e grano lusso type with spring and grub screw	•	•	1
	79 MR 009	Maniglia con rosetta Lever Handle on rose	009 mm 62x32	ovale con grano oval with grub screw	•	•	1
	79 MR 416	Maniglia con rosetta Lever Handle on rose	416 mm Ø45x9	con molla e grano with spring and grub screw	•	•	1

CREMONESE / WINDOW HANDLE WITH MECHANISM

	79 CR 137*	Cremonese con placca Window Handle on plate	137 mm 167x40	con fori viti con gioco with holes for screws with mechanism	•	•	2
--	------------	--	---------------	---	---	---	---

MARTELLINA / WINDOW HANDLE WITHOUT MECHANISM

	79 MA 137*	Martellina con placca Window Handle on plate	137 mm 167x40	q. 7 without mechanism with square-pin mm 7	•	•	2
--	------------	---	---------------	--	---	---	---

DREH KIPP / DREH KIPP

	79 DK 015	Dreh Kipp destro con rosetta Dreh Kipp (right) on rose	015 mm 65x31	con movimento in metallo with metal mechanism	•	•	3
	79 DK C67	Dreh Kipp destro con rosetta Safety Dreh Kipp (right) on rose	C67 mm 69x33	c/chiave e cilindro e mov. in metallo with key and cylinder and metal mec.	•	•	1

* Placca adatta a movimenti intercambiabili / Plate suitable to interchangeable movements

A RICHIESTA / ON REQUEST:

- Mezza maniglia con placca o con rosetta (specificare se destra o sinistra) / Half lever handle on plate or on rose (to specify if right or left)
- Maniglia con rosette senza bocchette / Lever handle on rose without rose for key
- Coppie impugnatura (CM) con grano e ferro senza rosette e senza bocchette / Pair levers (CM) with grub screws and square pin without rose and without rose for key
- Cremonesi e martelline con impugnatura a maniglia (segretini)
- Cremonese e martellina con placca coprivite e movimento intercambiabile

art. 80 CAPRI

materiale: Ottone
material: Solid Brass

Brass Class
100% Ottone

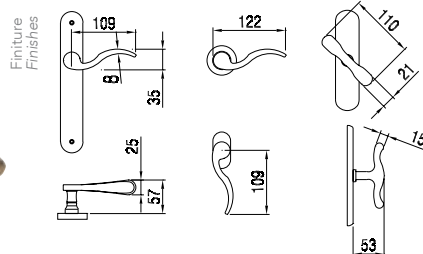

80 MR 004 BG



80 MR 006 AN

destro/right



80 DK 015 LV



80 MP 040 LV



80 MP 039 LV



80 MA 040 LV
80 CR 040 LV

VERSIONI / VERSIONS



Finiture
Finishes

LV BG AN

MANIGLIA CON PLACCA / LEVER HANDLE ON PLATE

	80 MP 040	Maniglia con placca Lever Handle on plate	040 mm 244x40	con molla e grano with spring and grub screw	•	•	1
	80 MP 039	Maniglia con placca Lever Handle on plate	039 mm 255x50	con molla e grano with spring and grub screw	•	•	1
	80 MP 026	Maniglia con placca Lever Handle on plate	026 mm 225x26	stretta con grano reduced with grub screw	•	•	1

MANIGLIA CON ROSETTA / LEVER HANDLE ON ROSE

	80 MR 004	Maniglia con rosetta Lever Handle on rose	004 mm Ø45x12	con molla e grano with spring and grub screw	•	•	2
	80 MR 005	Maniglia con rosetta Lever Handle on rose	005 mm Ø50x8	tipo lusso con molla e grano luxury type with spring and grub screw	•	•	2
	80 MR 006	Maniglia con rosetta Lever Handle on rose	006 mm Ø50x8	tipo lusso con molla e grano luxury type with spring and grub screw	•	•	2

CREMONESE / WINDOW HANDLE WITH MECHANISM

	80 CR 040*	Cremonese con placca Window Handle on plate	040 mm 174x37	con gioco with mechanism	•	•	2
--	------------	--	---------------	-----------------------------	---	---	---

MARTELLINA / WINDOW HANDLE WITHOUT MECHANISM

	80 MA 040*	Martellina con placca Window Handle on plate	040 mm 174x37	q.7 without mechanism square-pin mm 7	•	•	2
--	------------	---	---------------	--	---	---	---

DREH KIPP / DREH KIPP

	80 DK 015	Dreh Kipp destro con rosetta Dreh Kipp (right) on rose	015 mm 65x31	con movimento in metallo with metal mechanism	•	•	3
--	-----------	---	--------------	--	---	---	---

* Placca adatta a movimenti intercambiabili
Plate suitable to interchangeable movements

A RICHIESTA / ON REQUEST:

- Mezza maniglia con placca o con rosetta (specificare se destra o sinistra) / Half lever handle on plate or on rose (to specify if right or left)
- Maniglia con rosette senza bocchette / Lever handle on rose without rose for key
- Coppie impugnature (CM) con grano e ferro senza rosette e senza bocchette / Pair levers (CM) with grub screws and square pin without rose and without rose for key
- Cremonesi e martelline con impugnatura a maniglia (segretini)
- Cremonese e martellina con placca coprivite e movimento intercambiabile

art. 93 NORDICA

materiale: Ottone
material: Solid Brass

Brass Class
100% Ottone

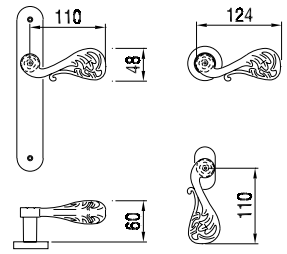

93 MR 207 AN



93 MR 207 AGV



93 MR 207 LV



93 MR 207 RX



93 MR 207 VBN



destro/right

93 DK 015 RX



destro/right

93 DK 015 VBN

VERSIONI / VERSIONS



Finiture
Finishes

MANIGLIA CON ROSETTA / LEVER HANDLE ON ROSE

93 MR 207 Maniglia con rosetta 207
Lever Handle on rose

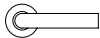

DREH KIPP / DREH KIPP

93 DK 015 Dreh Kipp destro con rosetta 015 mm 65x31 con movimento in metallo
Dreh Kipp (right) on rose with metal mechanism



	LV	AN	AGV	RX	VBN	
93 MR 207	•	•	•	•	•	1
93 DK 015	•	•	•	•	•	3

A RICHIESTA / ON REQUEST:

- Mezza maniglia con placca o con rosetta (specificare se destra o sinistra) / Half lever handle on plate or on rose (to specify if right or left)
- Maniglia con rosette senza bocchette / Lever handle on rose without rose for key
- Coppie impugnature (CM) con grano e ferro senza rosette e senza bocchette / Pair levers (CM) with grub screws and square pin without rose and without rose for key
- Cremonesi e martelline con impugnatura a maniglia (segretini)
- Cremonese e martellina con placca coprivite e movimento intercambiabile

art. 94 BERGEN

materiale: Ottone
material: Solid Brass

Brass Class
100% Ottone

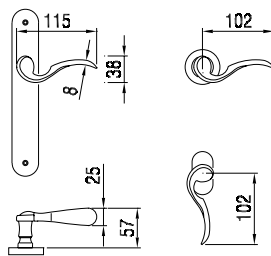

94 MR 011 AN



94 MR 006 LV



94 MR 202 AN



94 MR 202 AGV



94 MR 202 NC



94 MP 039 BG

destra/right



94 DK 015 LV

VERSIONI / VERSIONS



Finire
Finishes

MANIGLIA CON PLACCA / LEVER HANDLE ON PLATE

	LV	BG	AN	AGV	NC	
94 MP 039 Maniglia con placca / Lever Handle on plate 039 mm 255x50 con molla e grano / with spring and grub screw	•	•	•	•	•	1
94 MP 040 Maniglia con placca / Lever Handle on plate 040 mm 244x40 con molla e grano / with spring and grub screw	•	•	•	•	•	1

MANIGLIA CON ROSETTA / LEVER HANDLE ON ROSE

94 MR 004 Maniglia con rosetta / Lever Handle on rose 004 mm Ø45x9 con molla e grano / with spring and grub screw	•	•				2
94 MR 006 Maniglia con rosetta / Lever Handle on rose 006 mm Ø50x8 tipo lusso con molla e grano / lusso type with spring and grub screw	•	•	•	•	•	2
94 MR 011 Maniglia con rosetta / Lever Handle on rose 011 mm Ø52x9 tipo lusso con molla / lusso type with spring	•	•	•	•	•	1
94 MR 202 Maniglia con rosetta / Lever Handle on rose 202 mm Ø53x10 con bordo con grano / with edge with grub screw	•	•	•	•	•	5

DREH KIPP / DREH KIPP

94 DK 015 Dreh Kipp destro con rosetta / Dreh Kipp (right) on rose 015 mm 65x31 con movimento in metallo / with metal mechanism	•	•	•	•	•	3
---	---	---	---	---	---	---

A RICHIESTA / ON REQUEST:

- Mezza maniglia con placca o con rosetta (specificare se destra o sinistra) / Half lever handle on plate or on rose (to specify if right or left)
- Maniglia con rosette senza bocchette / Lever handle on rose without rose for key
- Coppie impugnature (CM) con grano e ferro senza rosette e senza bocchette / Pair levers (CM) with grub screws and square pin without rose and without rose for key

art. **97** UOVO

materiale: Ottone
material: Solid Brass

Brass Class
100% Ottone

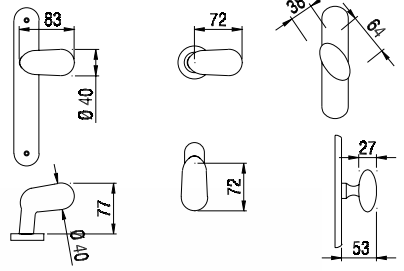

97 MR 006 LV



97 MR 006 BG



97 MR 416 OSC



97 MR 009 OC



97 MR 009 NR



97 MR 916 OSC



97 MP 066 LV



97 MA 137 LV
97 CR 137 LV



97 DK 015 LV



					LV	BG OS	OSC OC	NR	
MANIGLIA CON PLACCA / LEVER HANDLE ON PLATE									
	97 MP 066	Maniglia con placca Lever Handle on plate	066 mm 240x37	con molla e grano with spring and grub screw	•	•	•	•	1
	97 MP 248	Maniglia con placca Lever Handle on plate	248 mm 248x50	con molla e grano with spring and grub screw	•	•	•	•	1
MANIGLIA CON ROSETTA / LEVER HANDLE ON ROSE									
	97 MR 006	Maniglia con rosetta Lever Handle on rose	006 mm Ø50x8	tipo lusso con molla e grano lusso type with spring and grub screw	•	•	•	•	2
	97 MR 009	Maniglia con rosetta Lever Handle on rose	009 mm 62x32	ovale con molla e grano oval with spring and grub screw	•	•	•	•	1
	97 MR 416	Maniglia con rosetta Lever Handle on rose	416 mm Ø45x9	con molla e grano with spring and grub screw	•	•	•	•	1
	97 MR 916	Maniglia con rosetta Lever Handle on rose	916 mm 62x32	ovale con molla e grano oval with spring and grub screw	•	•	•	•	1
CREMONESE / WINDOW HANDLE WITH MECHANISM									
	97 CR 137	Cremonese con placca Window Handle on plate	137 mm 167x40	con fori viti con gioco with holes for screws with mechanism	•	•	•	•	2
	97 CR 070*	Cremonese con placca Window Handle on plate	070 mm 189x36	coprivite con gioco with cover-screw plate with mechanism	•	•	•	•	2
MARTELLINA / WINDOW HANDLE WITHOUT MECHANISM									
	97 MA 137	Martellina con placca Window Handle on plate	137 mm 167x40	con fori viti q. 7 with holes for screws with square-pin mm 7	•	•	•	•	2
	97 MA 070*	Martellina con placca Window Handle on plate	070 mm 189x36	coprivite q. 7 with cover-screw plate with square-pin mm 7	•	•	•	•	2
DREH KIPP / DREH KIPP									
	97 DK 015	Dreh Kipp con rosetta Dreh Kipp on rose	015 mm 65x31	con movimento in metallo with metal mechanism	•	•	•	•	2
	97 TK 015	Dreh Kipp con rosetta Dreh Kipp on rose	015 mm 65x31	con impugnatura martellina a "T" shape "T"	•	•	•	•	2
	* Placca adatta a movimenti intercambiabili Plate suitable to interchangeable movements								



97 MP 248 LV



97 TK 015 BG

Per caratteristiche tecniche rosette vedi apposito capitolo soluzioni tecniche e componenti / For technical specifications rosettes see specific section technical solutions and components

A RICHIESTA / ON REQUEST:

- Mezza maniglia con placca o con rosetta (specificare se destra o sinistra) / Half lever handle on plate or on rose (to specify if right or left)
- Maniglia con rosette senza bocchette / Lever handle on rose without rose for key
- Coppie impugnature (CM) con grano e ferro senza rosette e senza bocchette / Pair levers (CM) with grub screws and square pin without rose and without rose for key
- Cremonesi e martelline con impugnatura a maniglia (segretini)

art. 101 CLAUDIA

materiale: Ottone
material: Solid Brass

Brass Class
100% Ottone

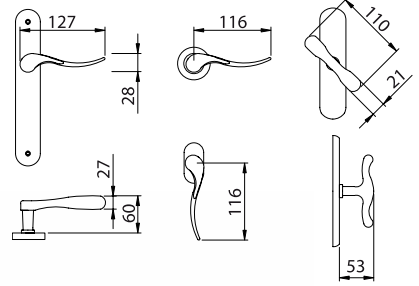

101 MR 005 LS



101 MR 005 BL



101 MR 004 BG



101 MR 005 OSC



101 MR 416 LV 



101 MP 040 LS



101 MA 040 LV
101 CR 040 LV



101 DK 015 LV

destra/right



						LV	LS	BL	BG	OSC	
MANIGLIA CON PLACCA / LEVER HANDLE ON PLATE											
	101 MP 101	Maniglia con placca Lever Handle on plate	101	mm 260x41	con molla e grano with spring and grub screw		•	•	•		1
	101 MP 040	Maniglia con placca Lever Handle on plate	040	mm 244x40	con molla e grano with spring and grub screw	•	•		•		1
	101 MP 026	Maniglia con placca Lever Handle on plate	026	mm 225x26	stretta con grano reduced with grub screw	•	•	•	•	•	1
	101 MP 039	Maniglia con placca Lever Handle on plate	039	mm 255x50	con molla e grano with spring and grub screw	•			•	•	1
	101 MP 188	Maniglia con placca Lever Handle on plate	188	mm 255x42	con molla e grano with spring and grub screw	•	•		•	•	1
MANIGLIA CON ROSETTA / LEVER HANDLE ON ROSE											
	101 MR 004	Maniglia con rosetta Lever Handle on rose	004	mm Ø45x9	con molla e grano with spring and grub screw	•	•	•	•	•	2
	101 MR 005	Maniglia con rosetta Lever Handle on rose	005	mm Ø50x8	tipo lusso con molla e grano luxu type with spring and grub screw	•	•	•	•	•	2
	101 MR 416	Maniglia con rosetta Lever Handle on rose	416	mm Ø45x9	con molla e grano with spring and grub screw	•	•	•	•	•	1
CREMONESE / WINDOW HANDLE WITH MECHANISM											
	101 CR 101	Cremonese con placca Window Handle on plate	101	mm 174x40	con gioco with mechanism		•	•	•		2
	101 CR 137*	Cremonese con placca Window Handle on plate	137	mm 167x40	con fori viti con gioco with holes for screws with mechanism	•	•			•	2
	101 CR 040*	Cremonese con placca Window Handle on plate	040	mm 174x37	con gioco with mechanism	•			•		2
MARTELLINA / WINDOW HANDLE WITHOUT MECHANISM											
	101 MA 101	Martellina con placca Window Handle on plate	101	mm 174x40	q. 7 without mechanism with square-pin mm 7		•	•	•		2
	101 MA 137*	Martellina con placca Window Handle on plate	137	mm 167x40	q. 7 without mechanism with square-pin mm 7	•			•	•	2
	101 MA 040*	Martellina con placca Window Handle on plate	040	mm 174x37	q. 7 without mechanism with square-pin mm 7	•			•		2
	101 MA 007	Martellina con rosetta Window Handle on rose	007	mm 67x27	q.7 without mechanism with square-pin mm 7	•			•	•	2
DREH KIPP / DREH KIPP											
	101 DK 015	Dreh Kipp destro con rosetta Dreh Kipp (right) on rose	015	mm 65x31	con movimento in metallo with metal mechanism	•	•	•	•	•	3
	* Placca adatta a movimenti intercambiabili Plate suitable to interchangeable movements										



101 MP 101 BL

101 MA 101 BL
101 CR 101 BL

Per caratteristiche tecniche rosette vedi apposito capitolo soluzioni tecniche e componenti / For technical specifications rosettes see specific section technical solutions and components

A RICHIESTA / ON REQUEST:

- Mezza maniglia con placca o con rosetta (specificare se destra o sinistra) / Half lever handle on plate or on rose (to specify if right or left)
- Maniglia con rosette senza bocchette / Lever handle on rose without rose for key
- Coppie impugnature (CM) con grano e ferro senza rosette e senza bocchette / Pair levers (CM) with grub screws and square pin without rose and without rose for key
- Cremonesi e martelline con impugnatura a maniglia (segretini)
- Cremonese e martellina con placca coprivite e movimento intercambiabile

art. 104 SCARABEO

materiale: Ottone
material: Solid Brass

Brass Class
100% Ottone

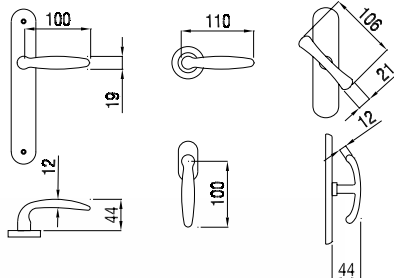

104 MR 006 LV



104 MR 416 LV



104 MR 006 OC



104 MR 004 OSC



104 MR 004 BG



104 MP 066 LV



104 MA 137 LV
104 CR 137 LV



104 DK 015 LV
104 DK 024 LV

VERSIONI / VERSIONS



Finiture
Finishes

LV
LS

BG
OS



OSC
OC

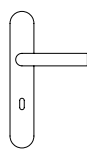

MANIGLIA CON PLACCA / LEVER HANDLE ON PLATE

	104 MP 066	Maniglia con placca Lever Handle on plate	066	mm 240x37	con molla with spring	•	•	1
	104 MP 066	Maniglia con placca Lever Handle on plate	066	mm 240x37	con molla e grano with spring and grub screw	•	•	1
	104 MP 026	Maniglia con placca Lever Handle on plate	026	mm 225x26	"stretta" con grano "reduced" with grub screw	•	•	1

MANIGLIA CON ROSETTA / LEVER HANDLE ON ROSE

	104 MR 004	Maniglia con rosetta Lever Handle on rose	004	mm Ø45x9	con molla e grano with spring and grub screw	•	•	5
	104 MR 006	Maniglia con rosetta Lever Handle on rose	006	mm Ø50x8	tipo lusso con molla e grano luxu type with spring and grub screw	•	•	2
	104 MR 009	Maniglia con rosetta Lever Handle on rose	009	mm 62x32	ovale con molla e grano oval with spring and grub screw	•	•	1
	104 MR 416	Maniglia con rosetta Lever Handle on rose	416	mm Ø45x9	con molla e grano with spring and grub screw	•	•	5



CREMONESE / WINDOW HANDLE WITH MECHANISM

	104 CR 137*	Cremonese con placca Window Handle on plate	137	mm 167x40	con fori viti con gioco with holes for screws with mechanism	•	•	6
---	-------------	--	-----	-----------	---	---	---	---

MARTELLINA / WINDOW HANDLE WITHOUT MECHANISM

	104 MA 137*	Martellina con placca Window Handle on plate	137	mm 167x40	con fori viti q.7 with holes for screws with square-pin mm 7	•	•	6
---	-------------	---	-----	-----------	---	---	---	---

DREH KIPP / DREH KIPP

	104 DK 015	Dreh Kipp con rosetta Dreh Kipp on rose	015	mm 65x31	con movimento in metallo with metal mechanism	•	•	6
	104 DK 024	Dreh Kipp con rosetta Dreh Kipp on rose	024	mm 65x31	c/mov. in metallo e quadro autoregolante with metal mec. and adjustable square-pin	•	•	6
	104 DK 075	Dreh Kipp con rosetta Safety DK on rose	075	mm 64x30	con mov. securblock e pulsante di sicurezza with securblock system and push button	•	•	2
	104 DK C67	Dreh Kipp con rosetta Safety DK on rose	C67	mm 69x33	c/chiave e cilindro e mov. in metallo with key and cylinder and metal mec.	•	•	1

* Placca adatta a movimenti intercambiabili
Plate suitable to interchangeable movements



104 DK C67 LV

Per caratteristiche tecniche rosette vedi apposito capitolo soluzioni tecniche e componenti / For technical specifications rosettes see specific section technical solutions and components

A RICHIESTA / ON REQUEST:

- Mezza maniglia con placca o con rosetta (specificare se destra o sinistra) / Half lever handle on plate or on rose (to specify if right or left)
- Maniglia con rosette senza bocchette / Lever handle on rose without rose for key
- Coppie impugnature (CM) con grano e ferro senza rosette e senza bocchette / Pair levers (CM) with grub screws and square pin without rose and without rose for key
- Cremonesi e martelline con impugnatura a maniglia (segretini)
- Cremonese e martellina con placca coprivite e movimento intercambiabile

art. 119 Q-10

design: Studio Reguitti
 materiale: Ottone
 material: Solid Brass

Brass Class
 100% Ottone

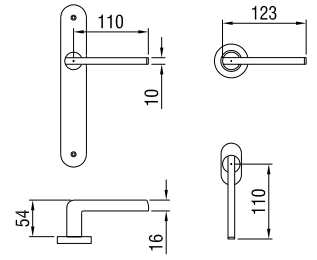

119 MR Q86 OSC 



119 MR 006 OSC



119 MR 416 LV 



119 MR 816 OC 



119 MR 916 OSC 



119 MR Q86 OC 



119 MP 188 OSC



119 SE Q13 OSC
 119 SG Q13 OSC

speciale
 special
 25



119 DK 025
 OSC



119 DK 015 OSC
 119 DK 024 OSC



119 DK Q15 OSC



MANIGLIA CON PLACCA / LEVER HANDLE ON PLATE



119 MP 130 Maniglia con placca
Lever Handle on plate 130 mm 245x50 con molla e grano
with spring and grub screw

119 MP 188 Maniglia con placca
Lever Handle on plate 188 mm 255x42 con molla e grano
with spring and grub screw

MANIGLIA SU ROSETTA / LEVER HANDLE ON ROSE

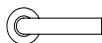

119 MR 006 Maniglia con rosetta
Lever Handle on rose 006 mm Ø50X8 con molla e grano
with spring and grub screw



119 MR 416 Maniglia con rosetta
Lever Handle on rose 416 mm Ø45X9 con molla e grano
with spring and grub screw



119 MR 816 Maniglia con rosetta
Lever Handle on rose 816 mm Ø50X10 con molla e grano
with spring and grub screw



119 MR 916 Maniglia con rosetta
Lever Handle on rose 916 mm 62x32 con molla e grano
with spring and grub screw



119 MR 9Q6 Maniglia con rosetta
Lever Handle on rose 9Q6 mm 61x31 con molla e grano
with spring and grub screw



119 MR Q86 Maniglia con rosetta
Lever Handle on rose Q86 mm 50x50 con molla e grano
with spring and grub screw

CREMONESE / WINDOW HANDLE WITH MECHANISM



119 SG Q13* Cremonese con placca
Window Handle on plate Q13 mm 160X33 coprivite con gioco
with cover-screw plate with mechanism

119 SG 070* Cremonese con placca
Window Handle on plate 070 mm 189x36 coprivite con gioco
with cover-screw plate with mechanism

MARTELLINA / WINDOW HANDLE WITHOUT MECHANISM

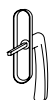

119 SE Q13* Martellina con placca
Window Handle on plate Q13 mm 160X33 with cover-screw plate with square-pin
mm 7 coprivite q.7

119 SE 070* Martellina con placca
Window Handle on plate 070 mm 189x36 with cover-screw plate with square-pin
mm 7 coprivite q.7

DREH KIPP / DREH KIPP



119 DK 015 Dreh Kipp con rosetta
Dreh Kipp on rose 015 mm 65x31 con movimento in metallo
with meta mechanism

119 DK 025 Dreh Kipp con rosetta
Dreh Kipp on rose 025 mm 65x25 con movimento in metallo
with meta mechanism



119 DK 024 Dreh Kipp con rosetta
Dreh Kipp on rose 024 mm 65x31 c/mov. in metallo e quadro regolabile
with metal mec. and adjustable square-pin

119 DK Q15 Dreh Kipp con rosetta
Dreh Kipp on rose Q15 mm 65x31 con movimento in metallo
with meta mechanism

* Placca adatta a movimenti intercambiabili
Plate suitable to interchangeable movements

Per caratteristiche tecniche rosette vedi apposito capitolo soluzioni tecniche e componenti / For technical specifications rosettes see specific section technical solutions and components

A RICHIESTA / ON REQUEST:

- Mezza maniglia con placca o con rosetta (specificare se destra o sinistra) / Half lever handle on plate or on rose (to specify if right or left)
- Maniglia con rosette senza bocchette / Lever handle on rose without rose for key
- Coppie impugnature (CM) con grano e ferro senza rosette e senza bocchette / Pair levers (CM) with grub screws and square pin without rose and without rose for key

art. 121 APRI

design: Studio Reguitti
 materiale: Ottone
 material: Solid Brass

Brass Class
 100% Ottone

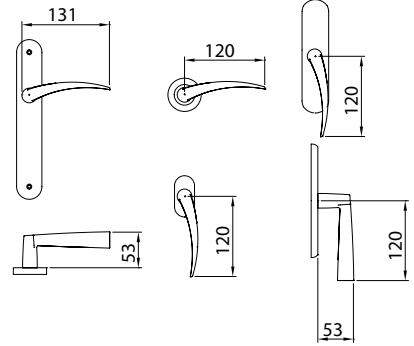

121 MR Q86 OSC



121 MR 816 OC



121 MR 416 OSC



121 MR 005 LV



121 MR 916 OS



121 MP 188 OSC

destro/right



121 DK 015 LV

destro/right



121 DK Q15 OC

VERSIONI / VERSIONS



Finishes

LV
OS

OSC
OC



MANIGLIA CON PLACCA / LEVER HANDLE ON PLATE

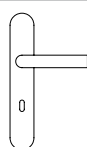

121 MP 188	Maniglia con placca Lever Handle on plate	188 mm 255x42	con molla e grano with spring and grub screw	•	•	1
121 MP 130	Maniglia con placca Lever Handle on plate	130 mm 245x50	con molla e grano with spring and grub screw	•	•	1

MANIGLIA CON ROSETTA / LEVER HANDLE ON ROSE



121 MR 005	Maniglia con rosetta Lever Handle on rose	005 mm Ø50x8	tipo lusso con molla e grano luxu type with spring and grub screw	•	•	1
121 MR 416	Maniglia con rosetta Lever Handle on rose	416 mm Ø45x9	con molla e grano with spring and grub screw	•	•	1
121 MR 816	Maniglia con rosetta Lever Handle on rose	816 mm Ø50x10	con molla e grano with spring and grub screw	•	•	1
121 MR 916	Maniglia con rosetta Lever Handle on rose	916 mm 62x32	ovale con molla e grano oval with spring and grub screw	•	•	1
121 MR 9Q6	Maniglia con rosetta Lever Handle on rose	9Q6 mm 61x31	con molla e grano with spring and grub screw	•	•	1
121 MR Q86	Maniglia con rosetta Lever Handle on rose	Q86 mm 50x50	con molla e grano with spring and grub screw	•	•	1

CREMONESE / WINDOW HANDLE WITH MECHANISM



121 SG 070*	Cremonese con placca Window Handle on plate	070 mm 189x36	coprivite con gioco with cover-screw plate with mechanism	•	•	2
121 SG Q13*	Cremonese con placca Window Handle on plate	Q13 mm 160x33	coprivite con gioco with cover-screw plate with mechanism	•	•	2

MARTELLINA / WINDOW HANDLE WITHOUT MECHANISM



121 SE 070*	Martellina con placca Window Handle on plate	070 mm 189x36	coprivite q.7 with cover-screw plate with square-pin mm 7	•	•	2
121 SE Q13*	Martellina con placca Window Handle on plate	Q13 mm 160x33	coprivite q.7 with cover-screw plate with square-pin mm 7	•	•	2

DREH KIPP / DREH KIPP



121 DK 015	Dreh Kipp destro con rosetta Dreh Kipp (right) on rose	015 mm 65x31	con movimento in metallo with metal mechanism	•	•	3
121 DK Q15	Dreh Kipp destro con rosetta Dreh Kipp (right) on rose	Q15 mm 65x31	con movimento in metallo with metal mechanism	•	•	3

* Placca adatta a movimenti intercambiabili
Plate suitable to interchangeable movements



121 MP 130 OSC



121 MR Q86 OC



121 MR 9Q6 OSC

Per caratteristiche tecniche rosette vedi apposito capitolo soluzioni tecniche e componenti / For technical specifications rosettes see specific section technical solutions and components

A RICHIESTA / ON REQUEST:

- Mezza maniglia con placca o con rosetta (specificare se destra o sinistra) / Half lever handle on plate or on rose (to specify if right or left)
- Maniglia con rosette senza bocchette / Lever handle on rose without rose for key
- Coppie impugnature (CM) con grano e ferro senza rosette e senza bocchette / Pair levers (CM) with grub screws and square pin without rose and without rose for key

art. 122 ASOLA

design: Studio Reguitti
materiale: Impugnatura Zama
material: Lever Zamak

TeKnoMetal
Linea in zama

122 MR 416 ZSC 

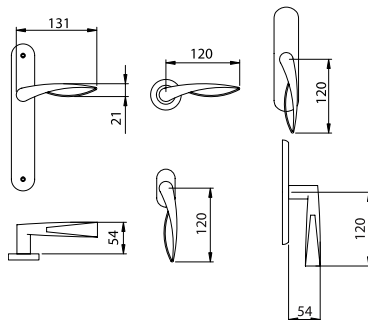

122 MR 006 ZCR

122 MR 009 ZCR



122 DK 015 ZSC

122 DK Q15 ZSC

VERSIONI / VERSIONS



Finiture
Finishes

ZSC
ZCR



MANIGLIA CON PLACCA / LEVER HANDLE ON PLATE



122 MP 188 Maniglia con placca 188 mm 255x42 con molla e grano
Lever Handle on plate with spring and grub screw

55,81 1

MANIGLIA CON ROSETTA / LEVER HANDLE ON ROSE



122 MR 006 Maniglia con rosetta 006 mm Ø50x8 tipo lusso con molla e grano
Lever Handle on rose lusso type with spring and grub screw

• 1

122 MR 009 Maniglia con rosetta 009 mm 62x32 ovale con molla e grano
Lever Handle on rose oval with spring and grub screw

• 1



122 MR 416 Maniglia con rosetta 416 mm Ø45x9 con molla e grano
Lever Handle on rose with spring and grub screw

• 1



122 MR 816 Maniglia con rosetta 816 mm Ø50x10 con molla e grano
Lever Handle on rose with spring and grub screw

• 1



122 MR 9Q6 Maniglia con rosetta 9Q6 mm 61x31 con molla e grano
Lever Handle on rose with spring and grub screw

• 1



122 MR Q86 Maniglia con rosetta Q86 mm 50x50 con molla e grano
Lever Handle on rose with spring and grub screw

• 1

CREMONESE / WINDOW HANDLE WITH MECHANISM



122 SG 070* Cremonese con placca 070 mm 189x36 coprivite con gioco
Window Handle on plate with cover-screw plate with mechanism

• 2

MARTELLINA / WINDOW HANDLE WITHOUT MECHANISM



122 SE 070* Martellina con placca 070 mm 189x36 coprivite q.7
Window Handle on plate with cover-screw plate with square-pin mm 7

• 2

DREH KIPP / DREH KIPP



122 DK 015 Dreh Kipp con rosetta 015 mm 65x31 con movimento in metallo
Dreh Kipp on rose with metal mechanism

• 2

122 DK Q15 Dreh Kipp con rosetta Q15 mm 65x31 con movimento in metallo
Dreh Kipp on rose with metal mechanism

• 2

* Placca adatta a movimenti intercambiabili / Plate suitable to interchangeable movements

A RICHIESTA / ON REQUEST:

- Mezza maniglia con placca o con rosetta (specificare se destra o sinistra) / Half lever handle on plate or on rose (to specify if right or left)
- Maniglia con rosette senza bocchette / Lever handle on rose without rose for key
- Coppie impugnature (CM) con grano e ferro senza rosette e senza bocchette / Pair levers (CM) with grub screws and square pin without rose and without rose for key

art. 123 DAFNE

design: Studio Reguitti
materiale: Impugnatura Zama
material: Lever Zamak

TeKnoMetal
Linea in zama



123 MR Q86 ZSC/ZCR 



123 MR 006 ZSC/ZCR



123 MR Q09 ZSC/ZCR

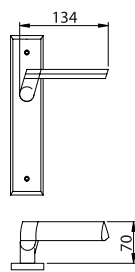

Destro/Right



Destro/Right

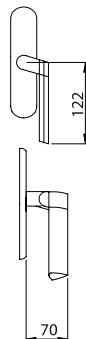

70



123 DK Q15 ZSC/ZCR/OSC









123 DK C70 ZSC/ZCR/OSC

VERSIONI / VERSIONS

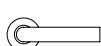

Finish
Finishes

MANIGLIA CON PLACCA / LEVER HANDLE ON PLATE

					ZSC/ZCR	ZSC/ZCR/OSC	
	123 MP 130	Maniglia con placca Lever Handle on plate	130 mm 245x50	con molla e grano with spring and grub screw	65,86	65,86	1
MANIGLIA CON ROSETTA / LEVER HANDLE ON ROSE							
	123 MR 006	Maniglia con rosetta Lever Handle on rose	006 mm Ø50x8	tipo lusso con molla e grano lusso type with spring and grub screw	•	•	1
	123 MR 009	Maniglia con rosetta Lever Handle on rose	009 mm 62x32	ovale con molla e grano oval with spring and grub screw	•	•	1
	123 MR 816	Maniglia con rosetta Lever Handle on rose	816 mm Ø50x10	con molla e grano with spring and grub screw	•	•	1
	123 MR Q09	Maniglia con rosetta Lever Handle on rose	Q09 mm 61x31	con molla e grano with spring and grub screw	•	•	1
	123 MR Q86	Maniglia con rosetta Lever Handle on rose	Q86 mm 50x50	con molla e grano with spring and grub screw	•	•	1

CREMONESE / WINDOW HANDLE WITH MECHANISM

	123 SG Q13*	Cremonese con placca Window Handle on plate	Q13 mm 160x33	coprivite con gioco with cover-screw plate with mechanism	•	•	2
---	-------------	--	---------------	--	---	---	---

MARTELLINA / WINDOW HANDLE WITHOUT MECHANISM

	123 SE Q13*	Martellina con placca Window Handle on plate	Q13 mm 160x33	coprivite q.7 with cover-screw plate with square-pin mm 7	•	•	2
---	-------------	---	---------------	--	---	---	---

DREH KIPP / DREH KIPP

	123 DK 015	Dreh Kipp destro con rosetta Dreh Kipp (right) on rose	015 mm 65x31	con movimento in metallo with metal mechanism	•	•	2
	123 DK Q15	Dreh Kipp destro con rosetta Dreh Kipp (right) on rose	Q15 mm 65x31	con movimento in metallo with metal mechanism	•	•	2
	123 DK C70	Dreh Kipp destro con rosetta Safety Dreh Kipp (right) on rose	C70 mm 69x33	c/ chiave e cilindro e movimento in metallo with key and cylinder and metal mechanism	•	•	1

* Placca adatta a movimenti intercambiabili / Plate suitable to interchangeable movements

A RICHIESTA / ON REQUEST:

- Mezza maniglia con placca o con rosetta (specificare se destra o sinistra) / Half lever handle on plate or on rose (to specify if right or left)
- Maniglia con rosette senza bocchette / Lever handle on rose without rose for key
- Coppie impugnature (CM) con grano e ferro senza rosette e senza bocchette / Pair levers (CM) with grub screws and square pin without rose and without rose for key

art. 124 Q-ARTE

design: Studio Reguitti
materiale: Impugnatura Zama
material: Lever Zamak

TeKnoMetal
Linea in zama

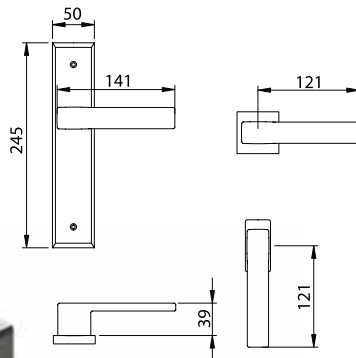

124 MR Q86 ZSC

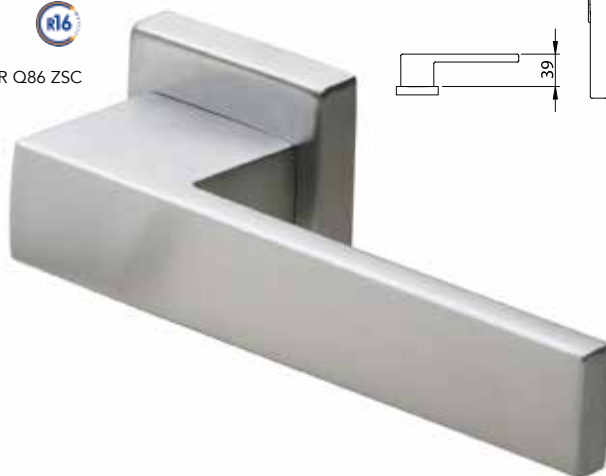

124 MR Q86 SNV



124 MR Q86 ZSC



124 MR Q86 SA



124 MR Q86 AV



124 MR Q86 VNR



124 MP 130 ZSC



124 DK Q15 ZSC

VERSIONI / VERSIONS



Finiture
Finishes

	ZSC	SNV	SA AV VNR	
MANIGLIA CON PLACCA / LEVER HANDLE ON PLATE				
124 MP 130 Maniglia con placca Lever Handle on plate 130 mm 245x50 con molla e grano with spring and grub screw	•	•		1
MANIGLIA CON ROSETTA QUADRATA / LEVER HANDLE ON SQUARE ROSE				
124 MR 9Q6 Maniglia con rosetta Lever Handle on rose 9Q6 mm 61x31 con molla e grano with spring and grub screw	•	•		1
124 MR Q86 Maniglia con rosetta Lever Handle on rose Q86 mm 50x50 con molla e grano with spring and grub screw	•	•	•	1
CREMONESE / WINDOW HANDLE WITH MECHANISM				
124 SG Q13* Cremonese con placca Window Handle on plate Q13 mm 160x33 coprivite con gioco with cover-screw plate with mec.	•	•		2
MARTELLINA / WINDOW HANDLE WITHOUT MECHANISM				
124 SE Q13* Martellina con placca Window Handle on plate Q13 mm 160x33 coprivite q.7 with cover-screw plate with square-pin mm 7	•	•		2
DREH KIPP / DREH KIPP				
124 DK Q15 Dreh Kipp con rosetta Dreh Kipp on rose Q15 mm 65x31 con movimento in metallo with metal mechanism	•	•	•	2

Vedi capitolo "Porte d'entrata"
See chapter "Entrance doors"



124 PF Q08 OSC



124 BA

Per caratteristiche tecniche rosette vedi apposito capitolo soluzioni tecniche e componenti / For technical specifications rosettes see specific section technical solutions and components

A RICHIESTA / ON REQUEST:

- Mezza maniglia con placca o con rosetta (specificare se destra o sinistra) / Half lever handle on plate or on rose (to specify if right or left)
- Maniglia con rosette senza bocchette / Lever handle on rose without rose for key
- Coppie impugnature (CM) con grano e ferro senza rosette e senza bocchette / Pair levers (CM) with grub screws and square pin without rose and without rose for key

art. 124 Q-ARTE Segmenti

design: Maurizio Duranti
materiale: Impugnatura Zama
material: Lever Zamak

TeKnoMetal
Linea in zama



124 MR Q86 SC/D3

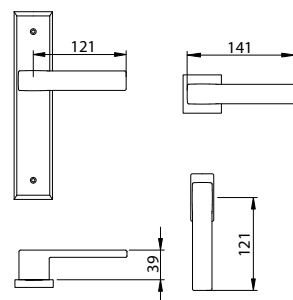

by
DURANTI DESIGN



124 MR Q86 VNR/D3



124 MR Q86 BGO/D3



124 DK C70 SC/D3



124 DK Q15 SC/D3

VERSIONI / VERSIONS



MANIGLIA SU PLACCA / LEVER HANDLE ON PLATE

124 MP 130 Maniglia con placca
Lever Handle on plate 130 mm 245x50

con molla e grano
with spring and grub screw

SC/D3	VNR/D3	SNV/D3 BGO/D3	
•	•	•	1
•	•	•	1
•			2
•			2
•	•	•	2
•			1

MANIGLIA SU ROSETTA / LEVER HANDLE ON ROSE

124 MR Q86 Maniglia con rosetta
Lever Handle on rose Q86 mm 50x50

con molla e grano
with spring and grub screw

CREMONESE / WINDOW HANDLE WITH MECHANISM

124 SG Q13* Cremonese con placca
Window Handle on plate Q13 mm 160x33

coprivite con gioco
with cover-screw plate with mechanism

MARTELLINA / WINDOW HANDLE WITHOUT MECHANISM

124 SE Q13* Martellina con placca
Window Handle on plate Q13 mm 160x33

coprivite q.7
with cover-screw plate with square-pin mm 7

DREH KIPP / DREH KIPP

124 DK Q15 Dreh Kipp con rosetta
Dreh Kipp on rose Q15 mm 65x31

con movimento in metallo
with metal mechanism

124 DK C70 Dreh Kipp con rosetta
Dreh Kipp on rose C70 mm 69x33

c/chave, cilindro e movimento in metallo
with key and cylinder and metal mechanism

* Placca adatta a movimenti intercambiabili
Plate suitable to interchangeable movements

art. 124 Q-ARTE Riga

design: Maurizio Duranti
materiale: Impugnatura Zama
material: Lever Zamak

TeKnoMetal
Linea in zama



124 MR Q86 SC/D4

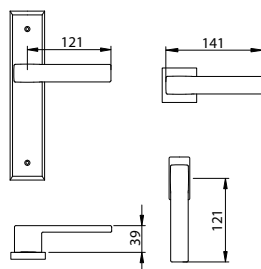

by
DURANTI DESIGN



124 MR Q86 CR/D4



124 MR Q86 VNR/D4



124 SE Q13 SNV/D4
124 SG Q13 SNV/D4



124 DK Q15 SC/D4



124 DK C70 SC/D4

VERSIONI / VERSIONS



Finiture
Finishes

MANIGLIA SU PLACCA / LEVER HANDLE ON PLATE

124 MP 130 Maniglia con placca 130 mm 245x50
Lever Handle on plate

con molla e grano
with spring and grub screw

SC/D4

VNR/D4

CR/D4
SNV/D4



1

MANIGLIA SU ROSETTA / LEVER HANDLE ON ROSE

 124 MR Q86 Maniglia con rosetta 86 mm 50x50
Lever Handle on rose

con molla e grano
with spring and grub screw

SC/D4

VNR/D4

CR/D4
SNV/D4

1

CREMONESE / WINDOW HANDLE WITH MECHANISM

124 SG Q13* Cremonese con placca 13 mm 160X33
Window Handle on plate

coprivite con gioco
with cover-screw plate with mechanism

SC/D4

VNR/D4

CR/D4
SNV/D4

2

MARTELLINA / WINDOW HANDLE WITHOUT MECHANISM

124 SE Q13* Martellina con placca 13 mm 160X33
Window Handle on plate

coprivite q.7
with cover-screw plate with square-pin mm 7

SC/D4

VNR/D4

CR/D4
SNV/D4

2

DREH KIPP / DREH KIPP

124 DK Q15 Dreh Kipp con rosetta 15 mm 65x31
Dreh Kipp on rose

con movimento in metallo
with metal mechanism

SC/D4

VNR/D4

CR/D4
SNV/D4

2

124 DK C70 Dreh Kipp con rosetta 70 mm 69x33
Dreh Kipp on rose

c/chiave, cilindro e movimento in metallo
with key and cylinder and metal mechanism

SC/D4

VNR/D4

CR/D4
SNV/D4

1

* Placca adatta a movimenti intercambiabili
Plate suitable to interchangeable movements

art. 124 Q-ARTE D-2

design: Studio Reguitti
materiale: Impugnatura Zamak
material: Lever Zamak

TeKnoMetal
Linea in zamak



124 MR Q86 SC/D2

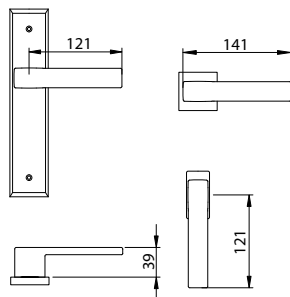

124 MR Q86 VNR/D2



124 DK Q15 SC/D2

VERSIONI / VERSIONS



Finiture
Finishes

				SC/D2	CR/D2	VNR/D2	
MANIGLIA SU PLACCA / LEVER HANDLE ON PLATE							
124 MP 130	Maniglia con placca <i>Lever Handle on plate</i>	130 mm 245x50	con molla e grano <i>with spring and grub screw</i>	•	•	•	1
MANIGLIA SU ROSETTA / LEVER HANDLE ON ROSE							
124 MR Q86	Maniglia con rosetta <i>Lever Handle on rose</i>	Q86 mm 50x50	con molla e grano <i>with spring and grub screw</i>	•	•	•	1
CREMONESE / WINDOW HANDLE WITH MECHANISM							
124 SG Q13*	Cremonese con placca <i>Window Handle on plate</i>	Q13 mm 160X33	coprivite con gioco <i>with cover-screw plate with mechanism</i>	•			2
MARTELLINA / WINDOW HANDLE WITHOUT MECHANISM							
124 SE Q13*	Martellina con placca <i>Window Handle on plate</i>	Q13 mm 160X33	coprivite q.7 <i>with cover-screw plate with square-pin mm 7</i>	•			2
DREH KIPP / DREH KIPP							
124 DK Q15	Dreh Kipp con rosetta <i>Dreh Kipp on rose</i>	Q15 mm 65x31	con movimento in metallo <i>with metal mechanism</i>	•	•	•	2
124 DK C70	Dreh Kipp con rosetta <i>Dreh Kipp on rose</i>	C70 mm 69x33	c/chave, cilindro e movimento in metallo <i>with key and cylinder and metal mechanism</i>	•	•		1

* Placca adatta a movimenti intercambiabili
Plate suitable to interchangeable movements

art. 124 Q-ARTE

Decorata con cristalli Swarovski®

design: Studio Reguitti
materiale: Impugnatura Zama
material: Lever Zamak

TeKnoMetal
Linea in zama



124 MR Q86 SC/SW3

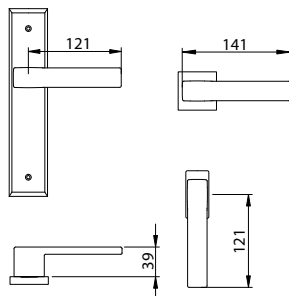

124 MR Q86 SC/SW7



124 MR Q86 VNR/SW3



124 DK Q15 SC/SW3



124 DK C70 SC/SW3

VERSIONI / VERSIONS



Finiture
Finishes

MANIGLIA SU PLACCA / LEVER HANDLE ON PLATE				SC/ SW3	SC/ SW7	VNR/ SW3	VNR/ SW7	
124 MP 130	Maniglia con placca Lever Handle on plate	130 mm 245x50	con molla e grano with spring and grub screw	•	•	•	•	1
MANIGLIA SU ROSETTA / LEVER HANDLE ON ROSE								
124 MR Q86	Maniglia con rosetta Lever Handle on rose	Q86 mm 50x50	con molla e grano with spring and grub screw	•	•	•	•	1
CREMONESE / WINDOW HANDLE WITH MECHANISM								
124 SG Q13*	Cremonese con placca Window Handle on plate	Q13 mm 160x33	coprivite con gioco with cover-screw plate with mechanism	•	•			2
MARTELLINA / WINDOW HANDLE WITHOUT MECHANISM								
124 SE Q13*	Martellina con placca Window Handle on plate	Q13 mm 160x33	coprivite q.7 with cover-screw plate with square-pin mm 7	•	•			2
DREH KIPP / DREH KIPP								
124 DK Q15	Dreh Kipp con rosetta Dreh Kipp on rose	Q15 mm 65x31	con movimento in metallo with metal mechanism	•	•	•	•	2
124 DK C70	Dreh Kipp con rosetta Dreh Kipp on rose	C70 mm 69x33	c/chiave, cilindro e movimento in metallo with key and cylinder and metal mechanism	•	•			1

* Placca adatta a movimenti intercambiabili
Plate suitable to interchangeable movements

art. 125 TRIADE

design: Marco Pialorsi
 materiale: Impugnatura Zama
 material: Lever Zamak

TeKnoMetal
 Linea in zama

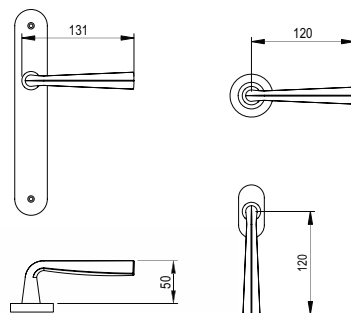

125 MR 416 ZSC



125 MR 008 SNV



125 MR 009 ZSC



125 MR 816 ZCR



125 MR 816 ZSC



125 MP 188 ZSC



125 SE 070 ZSC
 125 SG 070 ZSC







125 DK 024 ZSC

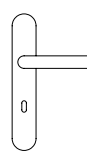

MANIGLIA CON PLACCA / LEVER HANDLE ON PLATE

	125 MP 188	Maniglia con placca Lever Handle on plate	188	mm 255x42	con molla e grano with spring and grub screw	•				1
	125 MP 130	Maniglia con placca Lever Handle on plate	130	mm 245x50	con molla e grano with spring and grub screw	•				1
	125 MP 026	Maniglia con placca Lever Handle on plate	026	mm 225x26	"stretta" con grano reduced with grub screw	•				1

MANIGLIA CON ROSETTA / LEVER HANDLE ON ROSE

	125 MR 004	Maniglia con rosetta Lever Handle on rose	004	mm Ø45x9	con molla e grano with spring and grub screw	•	32,16	•	•	2
	125 MR 005	Maniglia con rosetta Lever Handle on rose	005	mm Ø50x8	tipo lusso con molla e grano lusso type with spring and grub screw	•	44,02			1
	125 MR 007	Maniglia con rosetta Lever Handle on rose	007	mm 67x27	ovale stretta con grano oval and reduced with grub screw	•				2
	125 MR 008	Maniglia con rosetta Lever Handle on rose	008	mm Ø50x8	con molla e grano with spring and grub screw	•	34,24			2
	125 MR 009	Maniglia con rosetta Lever Handle on rose	009	mm 62x32	ovale con molla e grano oval with spring and grub screw	•			•	1
	125 MR 416	Maniglia con rosetta Lever Handle on rose	416	mm Ø45x9	con molla e grano with spring and grub screw	•	32,16	•		1
	125 MR 816	Maniglia con rosetta Lever Handle on rose	816	mm Ø50x10	con molla e grano with spring and grub screw	•	34,24			1
	125 MR Q08	Maniglia con rosetta Lever Handle on rose	Q08	mm 50x50	con molla e grano with spring and grub screw	•	41,21			1
	125 MR Q09	Maniglia con rosetta Lever Handle on rose	Q09	mm 61x31	con molla e grano with spring and grub screw	•	41,41			1



CREMONESE / WINDOW HANDLE WITH MECHANISM

	125 SG 070*	Cremonese con placca Window Handle on plate	070	mm 189x36	coprivite con gioco with cover-screw plate with mechanism	•				2
	125 SG Q13*	Cremonese con placca Window Handle on plate	Q13	mm 160x33	coprivite con gioco with cover-screw plate with mechanism	•				2

MARTELLINA / WINDOW HANDLE WITHOUT MECHANISM

	125 SE 070*	Martellina con placca Window Handle on plate	070	mm 189x36	coprivite q. 7 with cover-screw plate with square-pin mm 7	•				2
	125 SE Q13*	Martellina con placca Window Handle on plate	Q13	mm 160x33	coprivite q.7 with cover-screw plate with square-pin mm 7	•				2

DREH KIPP / DREH KIPP

	125 DK 015	Dreh Kipp con rosetta Dreh Kipp on rose	015	mm 65x31	con movimento in metallo with metal mechanism	•	•	•	•	3
	125 DK 024	Dreh Kipp con rosetta Dreh Kipp on rose	024	mm 65x31	c/mov. in metallo e quadro autoregolante with metal mec. and adjustable square-pin	•			•	3
	125 DK 075	Dreh Kipp con rosetta Safety DK on rose	075	mm 64x30	con mov. securblock e pulsante di sicurezza with securblock system and push button	•			•	2
	125 DK Q15	Dreh Kipp con rosetta Dreh Kipp on rose	Q15	mm 65x31	con movimento in metallo with metal mechanism	•			•	3

* Placca adatta a movimenti intercambiabili
Plate suitable to interchangeable movements



125 MR Q08 ZSC



125 MR Q09 ZSC



125 MP 130 ZSC

A RICHIESTA / ON REQUEST:

- Mezza maniglia con placca o con rosetta (specificare se destra o sinistra) / Half lever handle on plate or on rose (to specify if right or left)
- Maniglia con rosette senza bocchette / Lever handle on rose without rose for key
- Coppie impugnature (CM) con grano e ferro senza rosette e senza bocchette / Pair levers (CM) with grub screws and square pin without rose and without rose for key

art. 126 ROMBO

design: Marco Pialorsi
 materiale: Impugnatura Zama
 material: Lever Zamak

TeKnoMetal
 Linea in zama

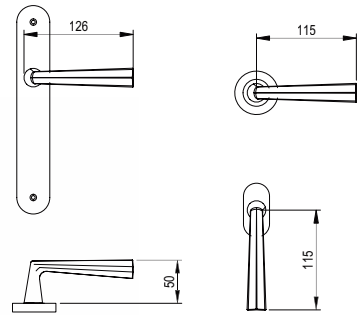

126 MR Q08 ZSC



126 MR 005 ZSC



126 MR 008 SNV



126 MR 009 ZSC



126 MR 416 ZCR



126 MR 816 ZSC



126 MP 188 ZSC



126 SE 070 ZSC
 126 SG 070 ZSC



126 DK 024 ZSC



Finiture
Finishes

ZSC
ZCR

SNV





PVD

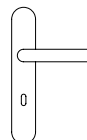

MANIGLIA CON PLACCA / LEVER HANDLE ON PLATE

	126 MP 188	Maniglia con placca Lever Handle on plate	188	mm 255X42	con molla e grano with spring and grub screw	•			1
	126 MP 130	Maniglia con placca Lever Handle on plate	130	mm 245X50	con molla e grano with spring and grub screw	•			1
	126 MP 026	Maniglia con placca Lever Handle on plate	026	mm 225x26	"stretta" con grano reduced with grub screw	•			1

MANIGLIA CON ROSETTA / LEVER HANDLE ON ROSE

	126 MR 004	Maniglia con rosetta Lever Handle on rose	004	mm Ø45x9	con molla e grano with spring and grub screw	•	•	•	2
	126 MR 005	Maniglia con rosetta Lever Handle on rose	005	mm Ø50x8	tipo lusso con molla e grano luxu type with spring and grub screw	•	•		1
	126 MR 007	Maniglia con rosetta Lever Handle on rose	007	mm 67x27	ovale stretta con grano oval and reduced with grub screw	•			2
	126 MR 008	Maniglia con rosetta Lever Handle on rose	008	mm Ø50x8	con molla e grano with spring and grub screw	•	•		2
	126 MR 009	Maniglia con rosetta Lever Handle on rose	009	mm 62x32	ovale con molla e grano oval with spring and grub screw	•		•	1
	126 MR 416	Maniglia con rosetta Lever Handle on rose	416	mm Ø45x9	con molla e grano with spring and grub screw	•	•	•	1
	126 MR 816	Maniglia con rosetta Lever Handle on rose	816	mm Ø50x10	con molla e grano with spring and grub screw	•	•		1
	126 MR Q08	Maniglia con rosetta Lever Handle on rose	Q08	mm 50x50	con molla e grano with spring and grub screw	•	•		1
	126 MR Q09	Maniglia con rosetta Lever Handle on rose	Q09	mm 61x31	con molla e grano with spring and grub screw	•	•		1



CREMONESE / WINDOW HANDLE WITH MECHANISM

	126 SG 070*	Cremonese con placca Window Handle on plate	070	mm 189x36	coprivite con gioco with cover-screw plate with mechanism	•			2
	126 SG Q13*	Cremonese con placca Window Handle on plate	Q13	mm 160x33	coprivite con gioco with cover-screw plate with mechanism	•			2

MARTELLINA / WINDOW HANDLE WITHOUT MECHANISM

	126 SE 070*	Martellina con placca Window Handle on plate	070	mm 189x36	coprivite q. 7 with cover-screw plate with square-pin 7	•			2
	126 SE Q13*	Martellina con placca Window Handle on plate	Q13	mm 160x33	coprivite q.7 with cover-screw plate with square-pin mm 7	•			2

DREH KIPP / DREH KIPP

	126 DK 015	Dreh Kipp con rosetta Dreh Kipp on rose	015	mm 65x31	con movimento in metallo with metal mechanism	•	•	•	3
	126 DK 024	Dreh Kipp con rosetta Dreh Kipp on rose	024	mm 65x31	c/mov. in metallo e quadro autoregolante with metal mec. and adjustable square-pin	•			3
	126 DK Q15	Dreh Kipp con rosetta Dreh Kipp on rose	Q15	mm 65x31	con movimento in metallo with metal mechanism	•		•	3

* Placca adatta a movimenti intercambiabili
Plate suitable to interchangeable movements



126 MR Q09 ZCR



126 MR 816 SNV



126 MP 130 ZSC

A RICHIESTA / ON REQUEST:

- Mezza maniglia con placca o con rosetta (specificare se destra o sinistra) / Half lever handle on plate or on rose (to specify if right or left)
- Maniglia con rosette senza bocchette / Lever handle on rose without rose for key
- Coppie impugnature (CM) con grano e ferro senza rosette e senza bocchette / Pair levers (CM) with grub screws and square pin without rose and without rose for key

art. 127 LORY

materiale: Ottone
material: Solid Brass

Brass Class
100% Ottone

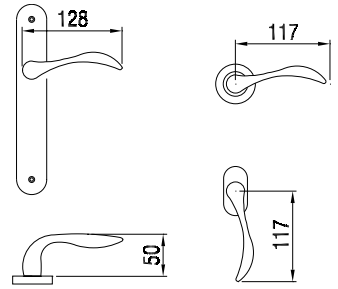

127 MR 006 OSC



127 MR 006 LV



127 MR 004 BGO



127 MR 008 OSC



127 MR 416 OC



127 MP 188 LV

destra/right



127 SE 070 LV
127 SG 070 LV

destra/right



127 DK 015 LV

VERSIONI / VERSIONS



Finiture
Finishes

						LV BG	OC OSC	BGO	
MANIGLIA CON PLACCA / LEVER HANDLE ON PLATE									
	127 MP 188	Maniglia con placca Lever Handle on plate	188	mm 255x42	con molla e grano with spring and grub screw	•	•	•	1
	127 MP 026	Maniglia con placca Lever Handle on plate	026	mm 225x26	stretta con grano reduced with grub screw	•	•		1
	127 MP 248	Maniglia con placca Lever Handle on plate	248	mm 248x50	con molla e grano with spring and grub screw	•	•	•	1
MANIGLIA CON ROSETTA / LEVER HANDLE ON ROSE									
	127 MR 004	Maniglia con rosetta Lever Handle on rose	004	mm Ø45x9	con molla e grano with spring and grub screw	•	•	•	2
	127 MR 006	Maniglia con rosetta Lever Handle on rose	006	mm Ø50x8	tipo lusso con molla e grano lusso type with spring and grub screw	•	•	•	1
	127 MR 008	Maniglia con rosetta Lever Handle on rose	008	mm Ø50x8	con molla e grano with spring and grub screw	•	•		2
	127 MR 009	Maniglia con rosetta Lever Handle on rose	009	mm 62x32	ovale con molla e grano oval with spring and grub screw	•	•	•	1
	127 MR 416	Maniglia con rosetta Lever Handle on rose	416	mm Ø45x9	con molla e grano with spring and grub screw	•	•	•	1
CREMONESE / WINDOW HANDLE WITH MECHANISM									
	127 SG 070*	Cremonese con placca Window Handle on plate	070	mm 189x36	coprivite con gioco with cover-screw plate with mechanism	•	•	•	2
MARTELLINA / WINDOW HANDLE WITHOUT MECHANISM									
	127 SE 070*	Martellina con placca Window Handle on plate	070	mm 189x36	coprivite q.7 with cover-screw plate with square-pin mm 7	•	•	•	2
DREH KIPP / DREH KIPP									
	127 DK 015	Dreh Kipp destro con rosetta Dreh Kipp (right) on rose	015	mm 65x31	con movimento in metallo with metal mechanism	•	•	•	3

* Placca adatta a movimenti intercambiabili
Plate suitable to interchangeable movements



127 MP 248 OSC

Per caratteristiche tecniche rosette vedi apposito capitolo soluzioni tecniche e componenti / For technical specifications rosettes see specific section technical solutions and components

A RICHIESTA / ON REQUEST:

- Mezza maniglia con placca o con rosetta (specificare se destra o sinistra) / Half lever handle on plate or on rose (to specify if right or left)
- Maniglia con rosette senza bocchette / Lever handle on rose without rose for key
- Coppie impugnature (CM) con grano e ferro senza rosette e senza bocchette / Pair levers (CM) with grub screws and square pin without rose and without rose for key

art. 128 NORMA

design: Marco Pialorsi
materiale: Ottone
material: Solid Brass

Brass Class
100% Ottone

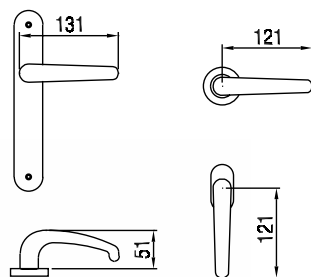

128 MR 006 LV



128 MR 006 OC



128 MR 006 OS



128 MR 008 OSC



128 MR 004 BG



128 MR 416 LV



128 MP 188 LV



128 SE 070 LV
128 SG 070 LV



128 DK 015 LV



Finiture
Finishes

					LV	BG	OS	OSC	OC	PVD	
MANIGLIA CON PLACCA / LEVER HANDLE ON PLATE											
	128 MP 066	Maniglia con placca Lever Handle on plate	066 mm 240x37	con molla e grano with spring and grub screw	•			•			1
	128 MP 049	Maniglia con placca Lever Handle on plate	049 mm 265X55	con molla e grano with spring and grub screw	•			•		•	1
	128 MP 188	Maniglia con placca Lever Handle on plate	188 mm 255X42	con molla e grano with spring and grub screw	•			•		•	1
MANIGLIA CON ROSETTA / LEVER HANDLE ON ROSE											
	128 MR 004	Maniglia con rosetta Lever Handle on rose	004 mm Ø45x9	con molla e grano with spring and grub screw	•			•		•	1
	128 MR 006	Maniglia con rosetta Lever Handle on rose	006 mm Ø50x8	tipo lusso con molla e grano lusso type with spring and grub screw	•			•		•	1
	128 MR 008	Maniglia con rosetta Lever Handle on rose	008 mm Ø50x8	con molla e grano with spring and grub screw	•			•			1
	128 MR 009	Maniglia con rosetta Lever Handle on rose	009 mm 62x32	ovale con molla e grano oval with spring and grub screw	•			•			1
	128 MR 416	Maniglia con rosetta Lever Handle on rose	416 mm Ø45x9	con molla e grano with spring and grub screw	•			•		•	1
	128 RW 004	Maniglia con rosetta Lever Handle on rose	004 mm Ø45x9	con WC 503 with WC turn 503	•			•		•	1
	128 RW 006	Maniglia con rosetta Lever Handle on rose	006 mm Ø50x8	tipo lusso con WC 503 lusso type with WC turn 503	•			•		•	1
	128 RG 004	Maniglia con rosetta Lever Handle on rose	004 mm Ø45x12	con WC 512 grande with WC turn 512	•			•			1
	128 RG 006	Maniglia con rosetta Lever Handle on rose	006 mm Ø50x8	lusso con WC 512 grande lusso type with WC turn 512	•			•			1
CREMONESE / WINDOW HANDLE WITH MECHANISM											
	128 SG 070*	Cremonese con placca Window Handle on plate	070 mm 189x36	coprivite con gioco with cover-screw plate with mechanism	•			•			2
MARTELLINA / WINDOW HANDLE WITHOUT MECHANISM											
	128 SE 070*	Martellina con placca Window Handle on plate	070 mm 189x36	coprivite q. 7 with cover-screw plate with square-pin mm 7	•			•			2
DREH KIPP / DREH KIPP											
	128 DK 015	Dreh Kipp con rosetta Dreh Kipp on rose	015 mm 65x31	con movimento in metallo with metal mechanism	•			•		•	3

* Placca adatta a movimenti intercambiabili
Plate suitable to interchangeable movements



128 MR 009 LV



128 MP 049-OSC

Per caratteristiche tecniche rosette vedi apposito capitolo soluzioni tecniche e componenti / For technical specifications rosettes see specific section technical solutions and components

A RICHIESTA / ON REQUEST:

- Mezza maniglia con placca o con rosetta (specificare se destra o sinistra) / Half lever handle on plate or on rose (to specify if right or left)
- Maniglia con rosette senza bocchette / Lever handle on rose without rose for key
- Coppie impugnature (CM) con grano e ferro senza rosette e senza bocchette / Pair levers (CM) with grub screws and square pin without rose and without rose for key

art. 129 WING

materiale: Ottone
material: Solid Brass

Brass Class
100% Ottone

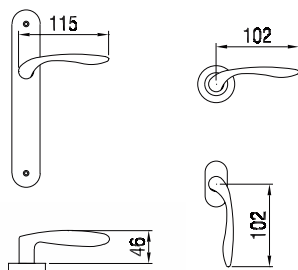

129 MR 006 LV



129 MR 006 OSC



129 MR 008 LV



129 MR 008 OC



129 MR 004 LV



129 MR 416 OSC



129 MP 188 LV

destra/right



129 SE 070 LV
129 SG 070 LV

destra/right







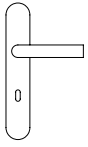

129 DK 015 LV

VERSIONI / VERSIONS



Finiture
Finishes

						LV BG	OC OSC	
MANIGLIA CON PLACCA / LEVER HANDLE ON PLATE								
	129 MP 188	Maniglia con placca Lever Handle on plate	188	mm 255x42	con molla e grano with spring and grub screw	•	•	1
	129 MP 026	Maniglia con placca Lever Handle on plate	026	mm 225x26	stretta con grano reduced with grub screw	•	•	1
	129 MP 248	Maniglia con placca Lever Handle on plate	248	mm 248x50	con molla e grano with spring and grub screw	•	•	1
MANIGLIA CON ROSETTA / LEVER HANDLE ON ROSE								
	129 MR 004	Maniglia con rosetta Lever Handle on rose	004	mm Ø45x9	con molla e grano with spring and grub screw	•	•	2
	129 MR 006	Maniglia con rosetta Lever Handle on rose	006	mm Ø50x8	tipo lusso con molla e grano luxury type with spring and grub screw	•	•	1
	129 MR 008	Maniglia con rosetta Lever Handle on rose	008	mm Ø50x8	con molla e grano with spring and grub screw	•	•	2
	129 MR 009	Maniglia con rosetta Lever Handle on rose	009	mm 62x32	ovale con molla e grano oval with spring and grub screw	•	•	1
	129 MR 416	Maniglia con rosetta Lever Handle on rose	416	mm Ø45x9	con molla e grano with spring and grub screw	•	•	1
CREMONESE / WINDOW HANDLE WITH MECHANISM								
	129 SG 070*	Cremonese con placca Window Handle on plate	070	mm 189x36	coprivite con gioco with cover-screw plate with mechanism	•	•	2
MARTELLINA / WINDOW HANDLE WITHOUT MECHANISM								
	129 SE 070*	Martellina con placca Window Handle on plate	070	mm 189x36	coprivite q.7 with cover-screw plate with square-pin mm 7	•	•	2
DREH KIPP / DREH KIPP								
	129 DK 015	Dreh Kipp destro con rosetta Dreh Kipp (right) on rose	015	mm 65x31	con movimento in metallo with metal mechanism	•	•	3

* Placca adatta a movimenti intercambiabili
Plate suitable to interchangeable movements



129 MR 009 OC



129 MP 248 OSC

Per caratteristiche tecniche rosette vedi apposito capitolo soluzioni tecniche e componenti / For technical specifications rosettes see specific section technical solutions and components

A RICHIESTA / ON REQUEST:

- Mezza maniglia con placca o con rosetta (specificare se destra o sinistra) / Half lever handle on plate or on rose (to specify if right or left)
- Maniglia con rosette senza bocchette / Lever handle on rose without rose for key
- Coppie impugnature (CM) con grano e ferro senza rosette e senza bocchette / Pair levers (CM) with grub screws and square pin without rose and without rose for key

art. 130 LASER

design: Studio Reguitti
materiale: Ottone
material: Solid Brass

Brass Class
100% Ottone

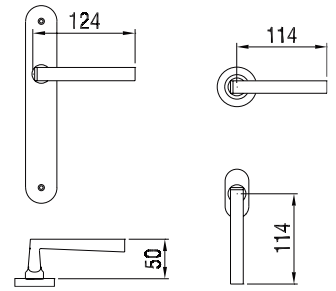

130 MR 005 OC



130 MR 005 LV



130 MR 005 OSC



130 MR 009 OSC



130 MR 008 OC



130 MR 416 OSC



130 MP 188 LV



130 SE 070 LV
130 SG 070 LV



130 DK 015 LV
130 DK 024 LV

VERSIONI / VERSIONS



Finiture
Finishes

LV
OS



OSC
OC

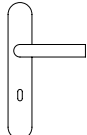

MANIGLIA CON PLACCA / LEVER HANDLE ON PLATE

	130 MP 026	Maniglia con placca Lever Handle on plate	026	stretta con grano reduced with grub screw	•	•	1
	130 MP 188	Maniglia con placca Lever Handle on plate	188	con molla e grano with spring and grub screw	•	•	1

MANIGLIA CON ROSETTA / LEVER HANDLE ON ROSE

	130 MR 004	Maniglia con rosetta Lever Handle on rose	004	mm Ø45x9	con molla e grano with spring and grub screw	•	•	2
	130 MR 005	Maniglia con rosetta Lever Handle on rose	005	mm Ø50x8	tipo lusso con molla e grano lusso type with spring and grub screw	•	•	1
	130 MR 008	Maniglia con rosetta Lever Handle on rose	008	mm Ø50x8	con molla e grano with spring and grub screw	•	•	2
	130 MR 009	Maniglia con rosetta Lever Handle on rose	009	mm 62x32	ovale con molla e grano oval with spring and grub screw	•	•	1
	130 MR 416	Maniglia con rosetta Lever Handle on rose	416	mm Ø45x9	con molla e grano with spring and grub screw	•	•	1



CREMONESE / WINDOW HANDLE WITH MECHANISM

	130 SG 070*	Cremonese con placca Window Handle on plate	070	mm 189x36	coprivite con gioco with cover-screw plate with mechanism	•	•	2
---	-------------	--	-----	-----------	--	---	---	---

MARTELLINA / WINDOW HANDLE WITHOUT MECHANISM

	130 SE 070*	Martellina con placca Window Handle on plate	070	mm 189x36	coprivite q.7 with cover-screw plate with square-pin mm 7	•	•	2
---	-------------	---	-----	-----------	--	---	---	---

DREH KIPP / DREH KIPP

	130 DK 015	Dreh Kipp con rosetta Dreh Kipp on rose	015	mm 65x31	con movimento in metallo with metal mechanism	•	•	3
	130 DK 024	Dreh Kipp con rosetta Dreh Kipp on rose	024	mm 65x31	c/mov. in metallo e quadro autoregolante with metal mec. and adjustable square-pin	•	•	3
	130 DK 075	Dreh Kipp con rosetta Safety DK on rose	075	mm 64x30	con mov. securblock e pulsante di sicurezza with securblock system and push button	•	•	2

* Placca adatta a movimenti intercambiabili
Plate suitable to interchangeable movements

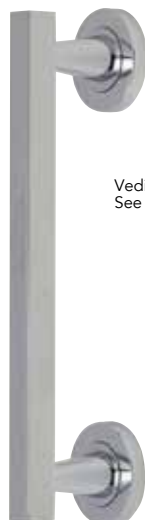

Vedi capitolo "Porte d'entrata"
See chapter "Entrance doors"

130 MD 005 OC

Per caratteristiche tecniche rosette vedi apposito capitolo soluzioni tecniche e componenti / For technical specifications rosettes see specific section technical solutions and components

A RICHIESTA / ON REQUEST:

- Mezza maniglia con placca o con rosetta (specificare se destra o sinistra) / Half lever handle on plate or on rose (to specify if right or left)
- Maniglia con rosette senza bocchette / Lever handle on rose without rose for key
- Coppie impugnature (CM) con grano e ferro senza rosette e senza bocchette / Pair levers (CM) with grub screws and square pin without rose and without rose for key

art. 130 LASER

design: Studio Reguitti
materiale: Ottone
material: Solid Brass

Brass Class
100% Ottone

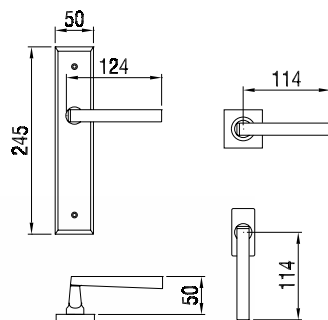

130 MR Q08 OSC



130 MR Q08 OSC

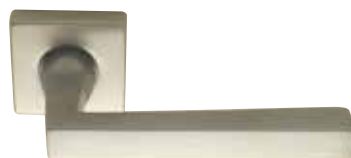

130 MR Q08 SNV



130 MR Q09 OSC



130 MP 130 OSC



130 DK Q15 OSC



Finishes
Finiture

LV
OS

OSC
OC

SNV



MANIGLIA CON PLACCA / LEVER HANDLE ON PLATE

	130 MP 130	Maniglia con placca Lever Handle on plate	130 mm 245x50	con molla e grano with spring and grub screw	•	•	•	1
--	------------	--	---------------	---	---	---	---	---

MANIGLIA CON ROSETTA QUADRATA / LEVER HANDLE ON SQUARE ROSE

	130 MR Q08	Maniglia con rosetta Lever Handle on rose	Q08 mm 50x50	con molla e grano with spring and grub screw	•	•	•	1
	130 MR Q09	Maniglia con rosetta Lever Handle on rose	Q09 mm 61x31	con molla e grano with spring and grub screw	•	•	•	1

CREMONESE / WINDOW HANDLE WITH MECHANISM

	130 SG Q13*	Cremonese con placca Window Handle on plate	Q13 mm 160x33	coprivite con gioco with cover-screw plate with mechanism	•	•	•	2
--	-------------	--	---------------	--	---	---	---	---

MARTELLINA / WINDOW HANDLE WITHOUT MECHANISM

	130 SE Q13*	Martellina con placca Window Handle on plate	Q13 mm 160x33	coprivite q.7 with cover-screw plate with square-pin mm 7	•	•	•	2
--	-------------	---	---------------	--	---	---	---	---

DREH KIPP / DREH KIPP

	130 DK Q15	Dreh Kipp con rosetta Dreh Kipp on rose	Q15 mm 65x31	con movimento in metallo with metal mechanism	•	•	•	3
	130 DK C70	Dreh Kipp con rosetta Safety DK on rose	C70 mm 69x33	con chiave e cilindro e movimento in metallo with key and cylinder and metal mechanism	•	•	•	1

* Placca adatta a movimenti intercambiabili
Plate suitable to interchangeable movements

Vedi capitolo "Porte scorrevoli"
See chapter "Sliding doors"

Vedi capitolo "Porte d'entrata"
See chapter "Entrance doors"



130 DK C70 OSC



305 MD Q11 OSC



130 MD Q50 OSC

Per caratteristiche tecniche rosette vedi apposito capitolo soluzioni tecniche e componenti / For technical specifications rosettes see specific section technical solutions and components

A RICHIESTA / ON REQUEST:

- Mezza maniglia con placca o con rosetta (specificare se destra o sinistra) / Half lever handle on plate or on rose (to specify if right or left)
- Maniglia con rosette senza bocchette / Lever handle on rose without rose for key
- Coppie impugnature (CM) con grano e ferro senza rosette e senza bocchette / Pair levers (CM) with grub screws and square pin without rose and without rose for key

art. 130 LASER

design: Studio Reguitti
 materiale: Impugnatura Zama
 material: Lever Zamak

TeKnoMetal
 Linea in zama

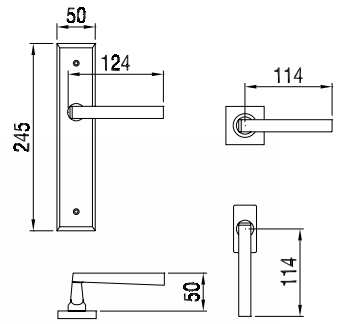

130 MR Q05-71 ZSC



130 MR Q08 SNV



130 MR 004 ZSC



130 MR 9Q6 ZSC



130 MR 005 ZSC



130 MR 008 SNV



130 MP 130 ZSC



130 DK 015 ZSC
 130 DK 024 ZSC



130 DK Q15 ZSC

VERSIONI / VERSIONS



					ZSC	SNV	
MANIGLIA CON PLACCA / LEVER HANDLE ON PLATE							
	130 MP 188	Maniglia con placca Lever Handle on plate	188 mm 255x42	con molla e grano with spring and grub screw	•	•	1
	130 MP 130	Maniglia con placca Lever Handle on plate	130 mm 245x50	con molla e grano with spring and grub screw	•	•	1
MANIGLIA CON ROSETTA / LEVER HANDLE ON ROSE							
	130 MR 004	Maniglia con rosetta Lever Handle on rose	004 mm Ø45x9	con molla e grano with spring and grub screw	•	•	2
	130 MR 005	Maniglia con rosetta Lever Handle on rose	005 mm Ø50x8	tipo lusso con molla e grano lusso type with spring and grub screw	•	•	1
	130 MR 008	Maniglia con rosetta Lever Handle on rose	008 mm Ø50x8	con molla e grano with spring and grub screw	•	•	2
	130 MR 009	Maniglia con rosetta Lever Handle on rose	009 mm 62x32	ovale con molla e grano oval with spring and grub screw	•	•	1
	130 MR 416	Maniglia con rosetta Lever Handle on rose	416 mm Ø45x9	con molla e grano with spring and grub screw	•	•	1
	130 MR 816	Maniglia con rosetta Lever Handle on rose	816 mm Ø50x10	con molla e grano with spring and grub screw	•	•	1
	130 MR 916	Maniglia con rosetta Lever Handle on rose	916 mm 62x32	ovale con molla e grano oval with spring and grub screw	•	•	1
	130 MR 9Q6	Maniglia con rosetta Lever Handle on rose	9Q6 mm 61x31	con molla e grano with spring and grub screw	•	•	1
	130 MR Q05-71	Maniglia con rosetta Lever Handle on rose	Q05 mm 50x50	lusso con molla e grano con bocchetta Q08 lusso type w/spring, grub screw, rose for key Q08	•	•	1
	130 MR Q05-72	Maniglia con rosetta Lever Handle on rose	Q05 mm 50x50	lusso con molla e grano con bocchetta Q08 yale lusso type w/spring, grub screw, rose for key Q08 yale	•	•	1
	130 MR Q08	Maniglia con rosetta Lever Handle on rose	Q08 mm 50x50	con molla e grano with spring and grub screw	•	•	1
CREMONESE / WINDOW HANDLE WITH MECHANISM							
	130 SG 070*	Cremonese con placca Window Handle on plate	070 mm 189x36	coprivite con gioco with cover-screw plate with mechanism	•	•	2
	130 SG Q13*	Cremonese con placca Window Handle on plate	Q13 mm 160x33	coprivite con gioco with cover-screw plate with mechanism	•	•	2
MARTELLINA / WINDOW HANDLE WITHOUT MECHANISM							
	130 SE 070*	Martellina con placca Window Handle on plate	070 mm 189x36	coprivite q.7 with cover-screw plate with square-pin mm 7	•	•	2
	130 SE Q13*	Martellina con placca Window Handle on plate	Q13 mm 160x33	coprivite q.7 with cover-screw plate with square-pin mm 7	•	•	2
DREH KIPP / DREH KIPP							
	130 DK 015	Dreh Kipp con rosetta Dreh Kipp on rose	015 mm 65x31	con movimento in metallo with metal mechanism	•	•	3
	130 DK 024	Dreh Kipp con rosetta Dreh Kipp on rose	024 mm 65x31	c/movimento in metallo e quadro autoregolante with metal mec. and adjustable square-pin	•	•	3
	130 DK 075	Dreh Kipp con rosetta Safety DK on rose	075 mm 64x30	con mov. securblock e pulsante di sicurezza with securblock system and push button	•	•	2
	130 DK Q15	Dreh Kipp con rosetta Dreh Kipp on rose	Q15 mm 65x31	con movimento in metallo with metal mechanism	•	•	3
	130 DK C67	Dreh Kipp con rosetta Safety DK on rose	C67 mm 69x33	con chiave e cilindro e movimento in metallo with key and cylinder and metal mechanism	•	•	1

* Placca adatta a movimenti intercambiabili
Plate suitable to interchangeable movements

Per caratteristiche tecniche rosette vedi apposito capitolo soluzioni tecniche e componenti / For technical specifications rosettes see specific section technical solutions and components

A RICHIESTA / ON REQUEST:

- Mezza maniglia con placca o con rosetta (specificare se destra o sinistra) / Half lever handle on plate or on rose (to specify if right or left)
- Maniglia con rosette senza bocchette / Lever handle on rose without rose for key
- Coppie impugnature (CM) con grano e ferro senza rosette e senza bocchette / Pair levers (CM) with grub screws and square pin without rose and without rose for key

art. 131 FLASH

design: Studio Reguitti
 materiale: Ottone
 material: Solid Brass

Brass Class
 100% Ottone

131 MR 005 OSC/OC

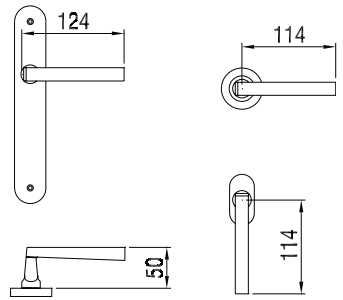

131 MR 005 OS/LV



rosetta OSC

131 MR 008 OSC/OC/OSC



rosetta OSC



131 MR 416 OSC/OC/OSC



131 MR 416 OSC/OC



131 MP 130 OS/LV



131 SE 070 OS/LV
 131 SG 070 OS/LV



131 DK 015 OS/LV
 131 DK 024 OS/LV



MANIGLIA CON PLACCA / LEVER HANDLE ON PLATE

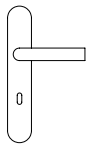

131 MP 188	Maniglia con placca Lever Handle on plate	188 mm 255x42	con molla e grano with spring and grub screw	•	•	•	1
131 MP 130	Maniglia con placca Lever Handle on plate	130 mm 245x50	con molla e grano with spring and grub screw	•	•	•	1

MANIGLIA CON ROSETTA / LEVER HANDLE ON ROSE

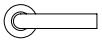

131 MR 004	Maniglia con rosetta Lever Handle on rose	004 mm Ø45x9	con molla e grano with spring and grub screw	•	•	•	1
131 MR 005	Maniglia con rosetta Lever Handle on rose	005 mm Ø50x8	tipo lusso con molla e grano lusso type with spring and grub screw	•	•	•	1
131 MR 008	Maniglia con rosetta Lever Handle on rose	008 mm Ø50x8	con molla e grano with spring and grub screw	•	•	•	1
131 MR 416	Maniglia con rosetta Lever Handle on rose	416 mm Ø45x9	con molla e grano with spring and grub screw	•	•	•	1
131 MR Q08	Maniglia con rosetta Lever Handle on rose	Q08 mm 50x50	con molla e grano with spring and grub screw	•	•	•	1
131 MR Q09	Maniglia con rosetta Lever Handle on rose	Q09 mm 61x31	con molla e grano with spring and grub screw	•	•	•	1



CREMONESE / WINDOW HANDLE WITH MECHANISM



131 SG 070*	Cremonese con placca Window Handle on plate	070 mm 189x36	coprivite con gioco with cover-screw plate with mechanism	•	•	•	2
131 SG Q13*	Cremonese con placca Window Handle on plate	Q13 mm 160x33	coprivite con gioco with cover-screw plate with mechanism	•	•	•	2

MARTELLINA / WINDOW HANDLE WITHOUT MECHANISM



131 SE 070*	Martellina con placca Window Handle on plate	070 mm 189x36	coprivite q.7 with cover-screw plate with square-pin mm 7	•	•	•	2
131 SE Q13*	Martellina con placca Window Handle on plate	Q13 mm 160x33	coprivite q.7 with cover-screw plate with square-pin mm 7	•	•	•	2

DREH KIPP / DREH KIPP



131 DK 015	Dreh Kipp con rosetta Dreh Kipp on rose	015 mm 65x31	con movimento in metallo with metal mechanism	•	•	•	3
131 DK Q15	Dreh Kipp con rosetta Dreh Kipp on rose	Q15 mm 65x31	con movimento in metallo with metal mechanism	•	•	•	3
131 DK 024	Dreh Kipp con rosetta Dreh Kipp on rose	024 mm 65x31	c/mov. in metallo e quadro autoregolante with metal mec. and adjustable square-pin	•	•	•	3
131 DK 075	Dreh Kipp con rosetta Safety DK on rose	075 mm 64x30	con mov. securblock e pulsante di sicurezza with securblock system and push button	•	•	•	2

* Placca adatta a movimenti intercambiabili
Plate suitable to interchangeable movements



131 DK Q15 OS/LV



131 MR Q09 OSC/OC



131 MR Q08 OSC/OC

Per caratteristiche tecniche rosette vedi apposito capitolo soluzioni tecniche e componenti / For technical specifications rosettes see specific section technical solutions and components

A RICHIESTA / ON REQUEST:

- Mezza maniglia con placca o con rosetta (specificare se destra o sinistra) / Half lever handle on plate or on rose (to specify if right or left)
- Maniglia con rosette senza bocchette / Lever handle on rose without rose for key
- Coppie impugnature (CM) con grano e ferro senza rosette e senza bocchette / Pair levers (CM) with grub screws and square pin without rose and without rose for key

art. 133 PHEDRA

materiale: Ottone
material: Solid Brass

Brass Class
100% Ottone

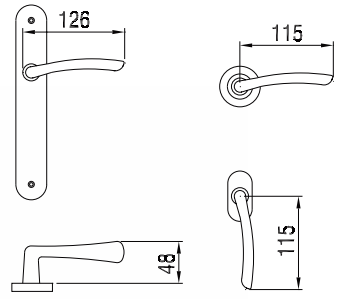

133 MR 006 LV



133 MR 006 OSC



133 MR 006 LV



133 MR 416 LV



133 MR 009 LV



133 MR 004 OSC



133 MP 188 OSC

destra/right



133 SE 070 OSC
133 SG 070 OSC

destra/right



133 DK 015 OSC



MANIGLIA CON PLACCA / LEVER HANDLE ON PLATE							
	133 MP 188	Maniglia con placca Lever Handle on plate	188 mm 255x42	con molla e grano with spring and grub screw	•	•	1
	133 MP 026	Maniglia con placca Lever Handle on plate	026 mm 225x26	stretta con grano reduced with grub screw	•	•	1
	133 MP 248	Maniglia con placca Lever Handle on plate	248 mm 248x50	con molla e grano with spring and grub screw	•	•	1
MANIGLIA CON ROSETTA / LEVER HANDLE ON ROSE							
	133 MR 004	Maniglia con rosetta Lever Handle on rose	004 mm Ø45x9	con molla e grano with spring and grub screw	•	•	2
	133 MR 006	Maniglia con rosetta Lever Handle on rose	006 mm Ø50x8	tipo lusso con molla e grano luxury type with spring and grub screw	•	•	1
	133 MR 007	Maniglia con rosetta Lever Handle on rose	007 mm 67x27	ovale stretta con grano oval and reduced with grub screw	•	•	2
	133 MR 008	Maniglia con rosetta Lever Handle on rose	008 mm Ø50x8	con molla e grano with spring and grub screw	•	•	1
	133 MR 009	Maniglia con rosetta Lever Handle on rose	009 mm 62x32	ovale con molla e grano oval with spring and grub screw	•	•	1
	133 MR 416	Maniglia con rosetta Lever Handle on rose	416 mm Ø45x9	con molla e grano with spring and grub screw	•	•	1
CREMONESE / WINDOW HANDLE WITH MECHANISM							
	133 SG 070*	Cremonese con placca Window Handle on plate	070 mm 189x36	coprivite con gioco with cover-screw plate with mechanism	•	•	2
MARTELLINA / WINDOW HANDLE WITHOUT MECHANISM							
	133 SE 070*	Martellina con placca Window Handle on plate	070 mm 189x36	coprivite q.7 with cover-screw plate with square-pin mm 7	•	•	2
DREH KIPP / DREH KIPP							
	133 DK 015	Dreh Kipp destro con rosetta Dreh Kipp (right) on rose	015 mm 65x31	con movimento in metallo with metal mechanism	•	•	3

* Placca adatta a movimenti intercambiabili
Plate suitable to interchangeable movements



133 MP 248 OSC

Per caratteristiche tecniche rosette vedi apposito capitolo soluzioni tecniche e componenti / For technical specifications rosettes see specific section technical solutions and components

A RICHIESTA / ON REQUEST:

- Mezza maniglia con placca o con rosetta (specificare se destra o sinistra) / Half lever handle on plate or on rose (to specify if right or left)
- Maniglia con rosette senza bocchette / Lever handle on rose without rose for key
- Coppie impugnature (CM) con grano e ferro senza rosette e senza bocchette / Pair levers (CM) with grub screws and square pin without rose and without rose for key

art. **133** PHEDRA

design: Studio Reguitti
 materiale: Impugnatura Zama
 material: Lever Zamak

TeKnoMetal
 Linea in zama

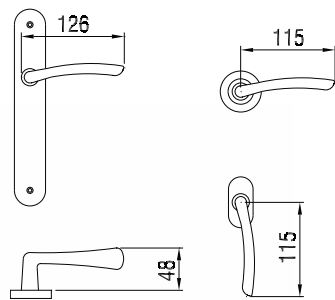

133 MR 006 ZCR



133 MR 006 ZSC



133 MR 004 ZSC



133 MR 006 SNV



133 MR 416 ZCR



133 MR 009 ZCR



133 MP 188 ZSC

destro/right



133 SE 070 ZSC
 133 SG 070 ZSC

destro/right



133 DK 015 ZSC

VERSIONI / VERSIONS



MANIGLIA CON PLACCA / LEVER HANDLE ON PLATE				ZSC ZCR	SNV		
	133 MP 188	Maniglia con placca Lever Handle on plate	188 mm 255x42	con molla e grano with spring and grub screw	•	•	1
	133 MP 026	Maniglia con placca Lever Handle on plate	026 mm 225x26	stretta con grano reduced with grub screw	•	•	1
MANIGLIA CON ROSETTA / LEVER HANDLE ON ROSE							
	133 MR 004	Maniglia con rosetta Lever Handle on rose	004 mm Ø45x9	con molla e grano with spring and grub screw	•	•	2
	133 MR 006	Maniglia con rosetta Lever Handle on rose	006 mm Ø50x8	tipo lusso con molla e grano luxury type with spring and grub screw	•	•	1
	133 MR 007	Maniglia con rosetta Lever Handle on rose	007 mm 67x27	ovale stretta con grano oval and reduced with grub screw	•	•	2
	133 MR 008	Maniglia con rosetta Lever Handle on rose	008 mm Ø50x8	con molla e grano with spring and grub screw	•	•	2
	133 MR 009	Maniglia con rosetta Lever Handle on rose	009 mm 62x32	ovale con molla e grano oval with spring and grub screw	•	•	1
	133 MR 416	Maniglia con rosetta Lever Handle on rose	416 mm Ø45x9	con molla e grano with spring and grub screw	•	•	1
133 MR 816	Maniglia con rosetta Lever Handle on rose	816 mm Ø50x10	con molla e grano with spring and grub screw	•	•	1	
CREMONESE / WINDOW HANDLE WITH MECHANISM							
	133 SG 070*	Cremonese con placca Window Handle on plate	070 mm 189x36	coprivite con gioco with cover-screw plate with mechanism	•	•	2
MARTELLINA / WINDOW HANDLE WITHOUT MECHANISM							
	133 SE 070*	Martellina con placca Window Handle on plate	070 mm 189x36	coprivite q.7 with cover-screw plate with square-pin mm 7	•	•	2
DREH KIPP / DREH KIPP							
	133 DK 015	Dreh Kipp destro con rosetta Dreh Kipp (right) on rose	015 mm 65x31	con movimento in metallo with metal mechanism	•	•	6
	133 DK C67	Dreh Kipp destro con rosetta Safety Dreh Kipp (right) on rose	C67 mm 69x33	con chiave e cilindro e movimento in metallo with key and cylinder and metal mechanism	•	•	1

* Placca adatta a movimenti intercambiabili
Plate suitable to interchangeable movements

destro/right



133 DK C67 ZSC

Per caratteristiche tecniche rosette vedi apposito capitolo soluzioni tecniche e componenti / For technical specifications rosettes see specific section technical solutions and components

A RICHIESTA / ON REQUEST:

- Mezza maniglia con placca o con rosetta (specificare se destra o sinistra) / Half lever handle on plate or on rose (to specify if right or left)
- Maniglia con rosette senza bocchette / Lever handle on rose without rose for key
- Coppie impugnature (CM) con grano e ferro senza rosette e senza bocchette / Pair levers (CM) with grub screws and square pin without rose and without rose for key

art. 134 ARCA

materiale: Ottone
material: Solid Brass

Brass Class
100% Ottone

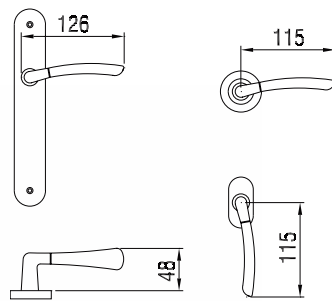

134 MR 006 OS/LV



134 MR 006 OSC/OC



134 MR 008 OS/LV



rosetta OSC

134 MR 416 OSC/OC/OSC



134 MR 416 OS/LV



134 MP 188 OSC/OC

destra/right



134 SE 070 OSC/OC
134 SG 070 OSC/OC

destra/right







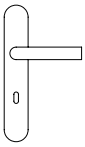

134 DK 015 OSC/OC

VERSIONI / VERSIONS



Finiture
Finishes

					OS/LV	OSC/OC	OSC/OC/OSC base Sat.Crom.	
MANIGLIA CON PLACCA / LEVER HANDLE ON PLATE								
	134 MP 188	Maniglia con placca Lever Handle on plate	188 mm 255x42	con molla e grano with spring and grub screw	•	•	•	1
	134 MP 248	Maniglia con placca Lever Handle on plate	248 mm 248x50	con molla e grano with spring and grub screw	•	•	•	1
MANIGLIA CON ROSETTA / LEVER HANDLE ON ROSE								
	134 MR 004	Maniglia con rosetta Lever Handle on rose	004 mm Ø45x9	con molla e grano with spring and grub screw	•	•	•	2
	134 MR 006	Maniglia con rosetta Lever Handle on rose	006 mm Ø50x8	tipo lusso con molla e grano luxury type with spring and grub screw	•	•	•	1
	134MR006-61	Maniglia con rosetta Lever Handle on rose	006 mm Ø50x8	lusso con molla e grano con bocchetta 068 luxury type w/spring, grub scr., rose for key 068	•	•	•	1
	134MR006-62	Maniglia con rosetta Lever Handle on rose	006 mm Ø50x8	lusso c.molla e grano c.bocchetta 068 yale l.type w/spr., grub scr. - rose for key 068 yale	•	•	•	1
	134 MR 008	Maniglia con rosetta Lever Handle on rose	008 mm Ø50x8	con molla e grano with spring and grub screw	•	•	•	1
	134 MR 009	Maniglia con rosetta Lever Handle on rose	009 mm 62x32	ovale con molla e grano oval with spring and grub screw	•	•	•	1
	134 MR 416	Maniglia con rosetta Lever Handle on rose	416 mm Ø45x9	con molla e grano with spring and grub screw	•	•	•	1
CREMONESE / WINDOW HANDLE WITH MECHANISM								
	134 SG 070*	Cremonese con placca Window Handle on plate	070 mm 189x36	coprivite con gioco with cover-screw plate with mechanism	•	•	•	2
MARTELLINA / WINDOW HANDLE WITHOUT MECHANISM								
	134 SE 070*	Martellina con placca Window Handle on plate	070 mm 189x36	coprivite q.7 with cover-screw plate with square-pin mm 7	•	•	•	2
DREH KIPP / DREH KIPP								
	134 DK 015	Dreh Kipp destro con rosetta Dreh Kipp (right) on rose	015 mm 65x31	con movimento in metallo with metal mechanism	•	•	•	3

* Placca adatta a movimenti intercambiabili
Plate suitable to interchangeable movements



Per caratteristiche tecniche rosette vedi apposito capitolo soluzioni tecniche e componenti / For technical specifications rosettes see specific section technical solutions and components

A RICHIESTA / ON REQUEST:

- Mezza maniglia con placca o con rosetta (specificare se destra o sinistra) / Half lever handle on plate or on rose (to specify if right or left)
- Maniglia con rosette senza bocchette / Lever handle on rose without rose for key
- Coppie impugnature (CM) con grano e ferro senza rosette e senza bocchette / Pair levers (CM) with grub screws and square pin without rose and without rose for key

art. 134 ARCA

design: Studio Reguitti
 materiale: Impugnatura Zama
 material: Lever Zamak

TeKnoMetal
 Linea in zama

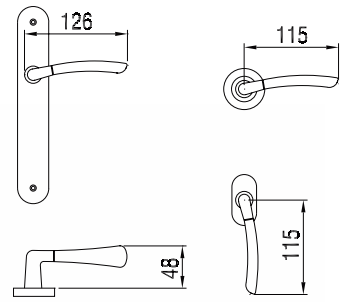

134 MR 006 ZSC/ZCR



134 MR 006 ZSC/ZCR



134 MR 008 ZSC/ZCR



134 MR 416 ZSC/ZCR/OSC



134 MR 416 ZSC/ZCR



134 MP 188 ZSC/ZCR



134 SE 070 ZSC/ZCR
 134 SG 070 ZSC/ZCR



134 DK 015 ZSC/ZCR

destra/right



destra/right

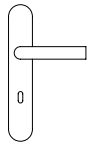

MANIGLIA CON PLACCA / LEVER HANDLE ON PLATE

	134 MP 188	Maniglia con placca Lever Handle on plate	188	mm 255x42	con molla e grano with spring and grub screw	•	•	1
--	------------	--	-----	-----------	---	---	---	---

MANIGLIA CON ROSETTA / LEVER HANDLE ON ROSE

	134 MR 004	Maniglia con rosetta Lever Handle on rose	004	mm Ø45x9	con molla e grano with spring and grub screw	•	•	2
	134 MR 006	Maniglia con rosetta Lever Handle on rose	006	mm Ø50x8	tipo lusso con molla e grano lusso type with spring and grub screw	•	•	1
	134MR006-61	Maniglia con rosetta Lever Handle on rose	006	mm Ø50x8	lusso con molla e grano con bocchetta 068 lusso type w/spring, grub scr., rose for key 068	•	•	1
	134MR006-62	Maniglia con rosetta Lever Handle on rose	006	mm Ø50x8	lusso c.molla e grano c.bocchetta 068 yale l.type w/spr., grub scr. - rose for key 068 yale	•	•	1
	134 MR 008	Maniglia con rosetta Lever Handle on rose	008	mm Ø50x8	con molla e grano with spring and grub screw	•	•	2
	134 MR 009	Maniglia con rosetta Lever Handle on rose	009	mm 62x32	ovale con molla e grano oval with spring and grub screw	•	•	1
	134 MR 416	Maniglia con rosetta Lever Handle on rose	416	mm Ø45x9	con molla e grano with spring and grub screw	•	•	1

CREMONESE / WINDOW HANDLE WITH MECHANISM

	134 SG 070*	Cremonese con placca Window Handle on plate	070	mm 189x36	coprivite con gioco with cover-screw plate with mechanism	•	•	2
---	-------------	--	-----	-----------	--	---	---	---

MARTELLINA / WINDOW HANDLE WITHOUT MECHANISM

	134 SE 070*	Martellina con placca Window Handle on plate	070	mm 189x36	coprivite q.7 with cover-screw plate with square-pin mm 7	•	•	2
---	-------------	---	-----	-----------	--	---	---	---

DREH KIPP / DREH KIPP

	134 DK 015	Dreh Kipp destro con rosetta Dreh Kipp (right) on rose	015	mm 65x31	con movimento in metallo with metal mechanism	•	•	6
---	------------	---	-----	----------	--	---	---	---

* Placca adatta a movimenti intercambiabili
Plate suitable to interchangeable movements



rosetta OSC



rosetta OSC



134 MR 006-61 ZSC/ZCR/OSC



134 MR 006-62 ZSC/ZCR/OSC

Per caratteristiche tecniche rosette vedi apposito capitolo soluzioni tecniche e componenti / For technical specifications rosettes see specific section technical solutions and components

A RICHIESTA / ON REQUEST:

- Mezza maniglia con placca o con rosetta (specificare se destra o sinistra) / Half lever handle on plate or on rose (to specify if right or left)
- Maniglia con rosette senza bocchette / Lever handle on rose without rose for key
- Coppie impugnature (CM) con grano e ferro senza rosette e senza bocchette / Pair levers (CM) with grub screws and square pin without rose and without rose for key

art. **136** ROUND

materiale: Ottone
material: Solid Brass

Brass Class
100% Ottone

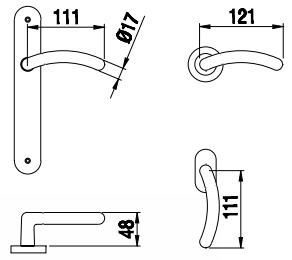

136 MR 006 OSC



136 MR 006 LV



136 MR 008 OSC



136 MR 416 OSC



136 MR 004 OC



136 MR 009 BG



136 MP 066 LV

destra/right



136 SE 070 LV
136 SG 070 LV

destra/right





136 DK 015 LV

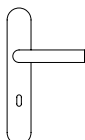

MANIGLIA CON PLACCA / LEVER HANDLE ON PLATE

	136 MP 066	Maniglia con placca Lever Handle on plate	066	mm 240x37	con molla e grano with spring and grub screw	•	•	1
--	------------	--	-----	-----------	---	---	---	---

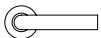
MANIGLIA CON ROSETTA / LEVER HANDLE ON ROSE

	136 MR 004	Maniglia con rosetta Lever Handle on rose	004	mm Ø45x9	con molla e grano with spring and grub screw	•	•	2
	136 MR 006	Maniglia con rosetta Lever Handle on rose	006	mm Ø50x8	tipo lusso con molla e grano lusso type with spring and grub screw	•	•	1
	136 MR 008	Maniglia con rosetta Lever Handle on rose	008	mm Ø50x8	con molla e grano with spring and grub screw	•	•	2
	136 MR 009	Maniglia con rosetta Lever Handle on rose	009	mm 62x32	ovale con molla e grano oval with spring and grub screw	•	•	1
	136 MR 416	Maniglia con rosetta Lever Handle on rose	416	mm Ø45x9	con molla e grano with spring and grub screw	•	•	1

CREMONESE / WINDOW HANDLE WITH MECHANISM

	136 SG 070	Cremonese con placca Window Handle on plate	070	mm 189x36	coprivite con gioco with cover-screw plate with mechanism	•	•	2
--	------------	--	-----	-----------	--	---	---	---

MARTELLINA / WINDOW HANDLE WITHOUT MECHANISM

	136 SE 070	Martellina con placca Window Handle on plate	070	mm 189x36	coprivite q.7 with cover-screw plate with square-pin mm 7	•	•	2
--	------------	---	-----	-----------	--	---	---	---

DREH KIPP / DREH KIPP

	136 DK 015	Dreh Kipp destro con rosetta Dreh Kipp (right) on rose	015	mm 65x31	con movimento in metallo with metal mechanism	•	•	3
---	------------	---	-----	----------	--	---	---	---

* Placca adatta a movimenti intercambiabili
Plate suitable to interchangeable movements

Per caratteristiche tecniche rosette vedi apposito capitolo soluzioni tecniche e componenti / For technical specifications rosettes see specific section technical solutions and components

A RICHIESTA / ON REQUEST:

- Mezza maniglia con placca o con rosetta (specificare se destra o sinistra) / Half lever handle on plate or on rose (to specify if right or left)
- Maniglia con rosette senza bocchette / Lever handle on rose without rose for key
- Coppie impugnature (CM) con grano e ferro senza rosette e senza bocchette / Pair levers (CM) with grub screws and square pin without rose and without rose for key

art. **137** DESY

design: Studio Reguitti
 materiale: Ottone
 material: Solid Brass

Brass Class
 100% Ottone

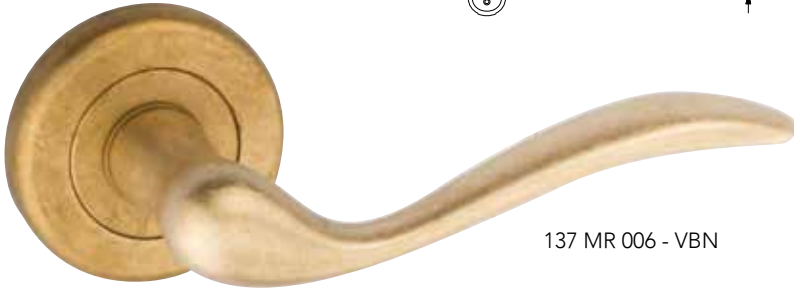
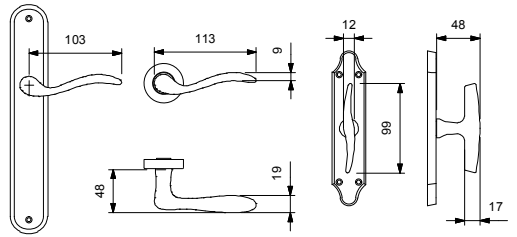

137 MR 006 - VBN



137 MR 006 - AGV



137 MA 007 - VBN



137 MP 039 - LV



137 MP 040 - VBN



137 MR 007 - VBN



137 CR 040 - LV
 137 MA 040 - LV



137 DK 015 - VBN



137 DK 075 - LV







137 MR 009 - BG

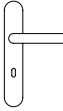

137 MR 004 - AN

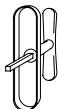

MANIGLIA CON PLACCA / LEVER HANDLE ON PLATE		€	€	€	€	€				
	137 MP 026 Maniglia con placca Lever handle on plate	026	mm 225x26	"stretta" "reduced"	•	•	•	•	•	1
	137 MP 039 Maniglia con placca Lever handle on plate	039	mm 255x50	con molla with spring	•	•	•	•	•	1
	137 MP 040 Maniglia con placca Lever handle on plate	040	mm 244x40	con molla with spring	•	•	•	•	•	1
	137 MP 188 Maniglia con placca Lever handle on plate	188	mm 255x42	con molla with spring	•	•	•	•	•	1
MANIGLIA CON ROSETTA / LEVER HANDLE ON ROSE		€	€	€	€	€				
	137 MR 004 Maniglia con rosetta Lever handle on rose	004	mm Ø45x9	con molla with spring	•	•	•	•	•	2
	137 MR 006 Maniglia con rosetta Lever handle on rose	006	mm Ø50x8	tipo lusso con molla lusso type with spring	•	•	•	•	•	2
	137 MR 007 Maniglia con rosetta Lever handle on rose	007	mm 67x27	ovale stretta oval and reduced	•	•	•	•	•	2
	137 MR 009 Maniglia con rosetta Lever handle on rose	009	mm 62x32	ovale con molla oval with spring	•	•	•	•	•	1
MARTELLINA / WINDOW HANDLE WITHOUT MECHANISM		€	€	€	€	€				
	137 MA 007 Martellina su rosetta Martellina on rose	007	mm 67x27	q.7 with square-pin mm 7	•	•	•	•	•	2
	137 MA 040* Martellina su placca Martellina on plate	040	mm 174x37	q.7 with square-pin mm 7	•	•	•	•	•	2
	137 MA 137* Martellina su placca Martellina on plate	137	mm 167x40	q.7 with square-pin mm 7	•	•	•	•	•	2
CREMONESE / WINDOW HANDLE WITH MECHANISM		€	€	€	€	€				
	137 CR 040* Cremonese con placca Cremon on plate	040	mm 174x37	con gioco with mechanism	•	•	•	•	•	2
	137 CR 137* Cremonese con placca Cremon on plate	137	mm 167x40	con gioco with mechanism	•	•	•	•	•	2
DREH KIPP / DREH KIPP		€	€	€	€	€				
	137 DK 015 Dreh kipp destro con rosetta Dreh Kipp (right) on rose	015	mm 65x31	con movimento in metallo with metal mechanism	•	•	•	•	•	3
	137 DK 075 Dreh kipp destro con rosetta Dreh Kipp (right) on rose	075	mm 64x30	con mov. securblock e puls. di sicurezza with securblock system and push button	•	•	•	•	•	2

* Placca adatta a movimenti intercambiabili
Plate suitable to interchangeable movements

Per caratteristiche tecniche rosette vedi apposito capitolo soluzioni tecniche e componenti / For technical specifications rosettes see specific section technical solutions and components

A RICHIESTA / ON REQUEST:

- Mezza maniglia con placca o con rosetta (specificare se destra o sinistra) / Half lever handle on plate or on rose (to specify if right or left)
- Maniglia con rosette senza bocchette / Lever handle on rose without rose for key
- Coppie impugnature (CM) con grano e ferro senza rosette e senza bocchette / Pair levers (CM) with grub screws and square pin without rose and without rose for key

art. 139 OPEN

design: Studio Reguitti
 materiale: Ottone
 material: Solid Brass

Brass Class
 100% Ottone

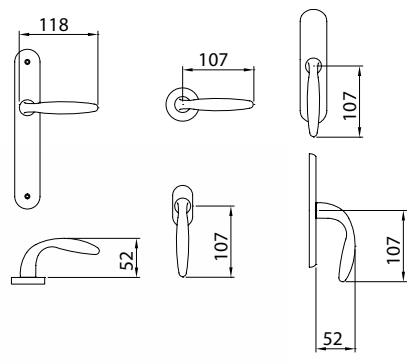

139 MR 006 LV



139 MR 004 OSC



139 MR 008 LV



139 MR 416 OSC



139 MR 006 BG



139 MR 916 LV



139 MP 037 OSC



139 SE 070 OSC
 139 SG 070 OSC



139 DK 015 OSC
 139 DK 024 OSC

VERSIONI / VERSIONS



Finiture
Finishes

LV
BG OS

OSC
OC



MANIGLIA CON PLACCA / LEVER HANDLE ON PLATE							
	139 MP 037	Maniglia con placca Lever Handle on plate	037 mm 255x42	con molla e grano with spring and grub screw	•	•	1
	139 MP 026	Maniglia con placca Lever Handle on plate	026 mm 225x26	stretta con grano reduced with grub screw	•	•	1
MANIGLIA CON ROSETTA / LEVER HANDLE ON ROSE							
	139 MR 004	Maniglia con rosetta Lever Handle on rose	004 mm Ø45x9	con molla e grano with spring and grub screw	•	•	2
	139 MR 006	Maniglia con rosetta Lever Handle on rose	006 mm Ø50x8	tipo lusso con molla e grano lusso type with spring and grub screw	•	•	2
	139 MR 008	Maniglia con rosetta Lever Handle on rose	008 mm Ø50x8	con molla e grano with spring and grub screw	•	•	2
	139 MR 416	Maniglia con rosetta Lever Handle on rose	416 mm Ø45x9	con molla e grano with spring and grub screw	•	•	5
	139 MR 916	Maniglia con rosetta Lever Handle on rose	916 mm 62x32	ovale con molla e grano oval with spring and grub screw	•	•	1
CREMONESE / WINDOW HANDLE WITH MECHANISM							
	139 SG 070*	Cremonese con placca Window Handle on plate	070 mm 189x36	coprivite con gioco with cover-screw plate with mechanism	•	•	2
MARTELLINA / WINDOW HANDLE WITHOUT MECHANISM							
	139 SE 070*	Martellina con placca Window Handle on plate	070 mm 189x36	coprivite q.7 with cover-screw plate with square-pin mm 7	•	•	2
DREH KIPP / DREH KIPP							
	139 DK 015	Dreh Kipp con rosetta Dreh Kipp on rose	015 mm 65x31	con movimento in metallo with metal mechanism	•	•	6
	139 DK 024	Dreh Kipp con rosetta Dreh Kipp on rose	024 mm 65x31	con mov. in metallo e quadro autoregolante with metal mec. and adjustable square-pin	•	•	6
	139 DK 075	Dreh Kipp con rosetta Safety DK on rose	075 mm 64x30	con mov. securblock e pulsante di sicurezza with securblock system and push button	•	•	2
	139 DK C67	Dreh Kipp con rosetta Safety DK on rose	C67 mm 69x33	con chiave e cilindro e movimento in metallo with key and cylinder and metal mechanism	•	•	1

*Placca adatta a movimenti intercambiabili
Plate suitable to interchangeable movements



139 DK C67 BG

Per caratteristiche tecniche rosette vedi apposito capitolo soluzioni tecniche e componenti / For technical specifications rosettes see specific section technical solutions and components

A RICHIESTA / ON REQUEST:

- Mezza maniglia con placca o con rosetta (specificare se destra o sinistra) / Half lever handle on plate or on rose (to specify if right or left)
- Maniglia con rosette senza bocchette / Lever handle on rose without rose for key
- Coppie impugnature (CM) con grano e ferro senza rosette e senza bocchette / Pair levers (CM) with grub screws and square pin without rose and without rose for key

art. 140 L-PLUS

design: Studio Reguitti
materiale: Ottone
material: Solid Brass

Brass Class
100% Ottone

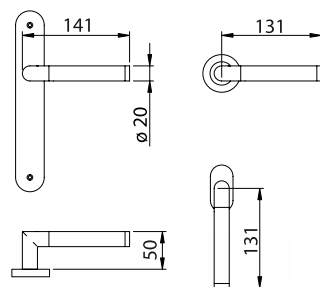

140 MR 005 OSC/OC



140 MR 005 NR/OC



140 MR Q86 OSC/OC



140 MR Q09 OSC/OC



140 MP 188 OSC/OC



140 DK 015 OSC/OC



140 DK Q15 OSC/OC

VERSIONI / VERSIONS



Finiture
Finishes

					OS/LV	OSC/OC	NR/OSC NR/OC	
MANIGLIA CON PLACCA / LEVER HANDLE ON PLATE								
	140 MP 188	Maniglia con placca Lever Handle on plate	188 mm 255x42	con molla e grano with spring and grub screw	•	•	•	1
	140 MP 130	Maniglia con placca Lever Handle on plate	130 mm 245x50	con molla e grano with spring and grub screw	•	•	•	1
MANIGLIA CON ROSETTA / LEVER HANDLE ON ROSE								
	140 MR 005	Maniglia con rosetta Lever Handle on rose	005 mm Ø50x8	tipo lusso con molla e grano lusso type with spring and grub screw	•	•	•	2
	140 MR 416	Maniglia con rosetta Lever Handle on rose	416 mm Ø45x9	con molla e grano with spring and grub screw	•	•	•	1
	140 MR Q09	Maniglia con rosetta Lever Handle on rose	Q09 mm 61x31	con molla e grano with spring and grub screw	•	•	•	1
	140 MR Q86	Maniglia con rosetta Lever Handle on rose	Q86 mm 50x50	con molla e grano with spring and grub screw	•	•	•	1
CREMONESE / WINDOW HANDLE WITH MECHANISM								
	140 SG 070*	Cremonese con placca Window Handle on plate	070 mm 189x36	coprivite con gioco with cover-screw plate with mechanism	•	•	•	2
MARTELLINA / WINDOW HANDLE WITHOUT MECHANISM								
	140 SE 070*	Martellina con placca Window Handle on plate	070 mm 189x36	coprivite q.7 with cover-screw plate with square-pin mm 7	•	•	•	2
DREH KIPP / DREH KIPP								
	140 DK 015	Dreh Kipp con rosetta Dreh Kipp on rose	015 mm 65x31	con movimento in metallo with metal mechanism	•	•	•	3
	140 DK Q15	Dreh Kipp con rosetta Dreh Kipp on rose	Q15 mm 65x31	con movimento in metallo with metal mechanism	•	•	•	2

* Placca adatta a movimenti intercambiabili
Plate suitable to interchangeable movements



140 MP 130 OSC/OC

Per caratteristiche tecniche rosette vedi apposito capitolo soluzioni tecniche e componenti / For technical specifications rosettes see specific section technical solutions and components

A RICHIESTA / ON REQUEST:

- Mezza maniglia con placca o con rosetta (specificare se destra o sinistra) / Half lever handle on plate or on rose (to specify if right or left)
- Maniglia con rosette senza bocchette / Lever handle on rose without rose for key
- Coppie impugnature (CM) con grano e ferro senza rosette e senza bocchette / Pair levers (CM) with grub screws and square pin without rose and without rose for key

art. 141 SPRING

design: Studio Reguitti
 materiale: Impugnatura Zama
 material: Lever Zamak

TeKnoMetal
 Linea in zama

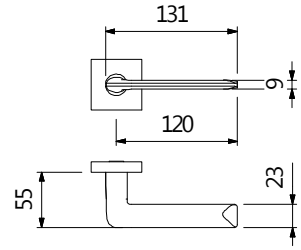

141 SG 070 - ZSC

141 SG Q90 - ZSC



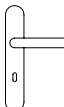

MANIGLIA CON PLACCA / LEVER HANDLE ON PLATE

				€	€	€	
	141 MP 130	Maniglia con placca Lever handle on plate	130 mm 245x50	con molla e grano with spring and grub screw	•	•	• 1
	141 MP 188	Maniglia con placca Lever handle on plate	188 mm 255x42	con molla e grano with spring and grub screw	•	•	• 1

MANIGLIA CON ROSETTA / LEVER HANDLE ON ROSE

					€	€	€	
	141 MR 004	Maniglia con rosetta Lever handle on rose	004 mm Ø45x9	con molla with spring	•	•	• 2	
	141 MR 006	Maniglia con rosetta Lever handle on rose	006 mm Ø50x8	tipo lusso con molla lusso type with spring	•	•	• 1	
	141 MR 008	Maniglia con rosetta Lever handle on rose	008 mm Ø50x8	con molla with spring	•	•	• 2	
	141 MR 009	Maniglia con rosetta Lever handle on rose	009 mm 62x32	ovale con molla oval with spring	•	•	• 1	
	141 MR 416	Maniglia con rosetta Lever handle on rose	416 mm Ø45x9	con molla with spring	•	•	• 1	
	141 MR 816	Maniglia con rosetta Lever handle on rose	816 mm Ø50x10	con molla with spring	•	•	• 1	
	141 MR 916	Maniglia con rosetta Lever handle on rose	916 mm 62x32	ovale con molla oval with spring	•	•	• 1	
	141 MR 9Q6	Maniglia con rosetta Lever handle on rose	9Q6 mm 61x31	con molla with spring	•	•	• 1	
	141 MR Q46	Maniglia con rosetta Lever handle on rose	Q46 mm 45x45	con molla with spring	•	•	• 1	
	141 MR Q86	Maniglia con rosetta Lever handle on rose	Q86 mm 50x50	con molla with spring	•	•	• 1	

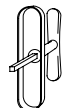

MARTELLINA / WINDOW HANDLE WITHOUT MECHANISM

					€	€	€	
	141 SE 070*	Martellina con placca Martellina on plate	070 mm 189x36	coprivite q.7 with cover-screw plate and sq.-pin mm 7	•	•	• 2	
	141 SE Q90*	Martellina con placca Martellina on plate	Q90 mm 190x38	coprivite q.7 with cov.scr.plate and sq.-pin mm 7	•	•	• 2	

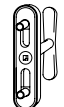
CREMONESE / WINDOW HANDLE WITH MECHANISM

					€	€	€	
	141 SG 070*	Cremonese con placca Cremon on plate	070 mm 189x36	coprivite con gioco with cover-screw plate with mechanism	•	•	• 2	
	141 SG Q90*	Cremonese con placca Cremon on plate	Q90 mm 190x38	coprivite con gioco with cover-screw plate with mechanism	•	•	• 2	

DREH KIPP / DREH KIPP

					€	€	€	
	141 DK 015	Dreh kipp con rosetta Dreh Kipp on rose	015 mm 65x31	con movimento in metallo with metal mechanism	•	•	• 3	
	141 DK Q15	Dreh kipp con rosetta Dreh Kipp on rose	Q15 mm 65x31	con movimento in metallo with metal mechanism	•	•	• 3	
	141 DK 075	Dreh kipp con rosetta Dreh Kipp on rose	075 mm 64x30	con mov. securblock e puls. di sicurezza with securblock system and push button	•	•	• 2	
	141 DK Q75	Dreh kipp con rosetta Dreh Kipp on rose	Q75 mm 64x30	con mov. securblock e puls. di sicurezza with securblock system and push button	•	•	• 2	

* Placca adatta a movimenti intercambiabili / Plate suitable to interchangeable movements

Per caratteristiche tecniche rosette vedi apposito capitolo soluzioni tecniche e componenti / For technical specifications rosettes see specific section technical solutions and components

A RICHIESTA / ON REQUEST:

- Mezza maniglia con placca o con rosetta (specificare se destra o sinistra) / Half lever handle on plate or on rose (to specify if right or left)
- Maniglia con rosette senza bocchette / Lever handle on rose without rose for key
- Coppie impugnature (CM) con grano e ferro senza rosette e senza bocchette / Pair levers (CM) with grub screws and square pin without rose and without rose for key

art. **142** Q-MINI

design: St. Reguitti - Mod. Dep.
 materiale: Impugnatura Zama
 material: Lever Zamak

TeKnoMetal
 Linea in zama

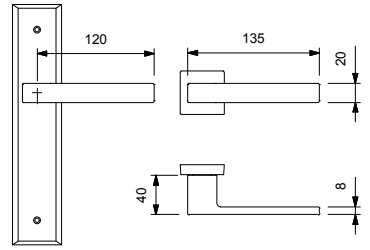

142 MR Q46 - ZSC



142 RQ Q46 - ZSC



142 RW Q46 - ZSC



142 MR 9Q6 - ZSC



142 MR Q56 - ZSC



142 MR Q86 - SNV



142 SE Q13 - ZSC
 142 SG Q13 - ZSC











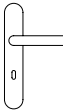



142 DK Q15 - ZSC

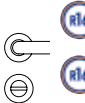

142 DK Q75 - ZSC



MANIGLIA CON PLACCA / LEVER HANDLE ON PLATE				€	€		
	142 MP 130	Maniglia con placca <i>Lever handle on plate</i>	130 mm 245x50	con molla <i>with spring</i>	•	•	1
MANIGLIA CON ROSETTA / LEVER HANDLE ON ROSE				€	€		
	142 MR 9Q6	Maniglia con rosetta <i>Lever handle on rose</i>	9Q6 mm 61x31	con molla <i>with spring</i>	•	•	1
	142 MR Q46	Maniglia con rosetta <i>Lever handle on rose</i>	Q46 mm 45x45	con molla <i>with spring</i>	•	•	1
	142MRQ56-71	Maniglia con rosetta <i>Lever handle on rose</i>	Q56 mm 50x50	Base in metallo con molla e bocc. Q08 <i>Internal metal - spring and Q08 key rose</i>	•	•	1
	142 MR Q86	Maniglia con rosetta <i>Lever handle on rose</i>	Q86 mm 50x50	con molla <i>with spring</i>	•	•	1
MANIGLIA CON ROSETTA E NOTTOLINO WC / LEVER HANDLE ON ROSE AND WC TURN				€	€		
	142 RQ Q46	Maniglia con rosetta <i>Lever handle on rose</i>	Q46 mm 45x45	con molla e nott. wc 124 <i>with spring and wc turn 124</i>	•	•	1
	142 RQ Q86	Maniglia con rosetta <i>Lever handle on rose</i>	Q86 mm 50x50	con molla e nott. wc 124 <i>with spring and wc turn 124</i>	•	•	1
MANIGLIA CON ROSETTA E NOTTOLINO WC / LEVER HANDLE ON ROSE AND WC TURN				€	€		
	142 RW Q46	Maniglia con rosetta <i>Lever handle on rose</i>	Q46 mm 45x45	con molla e nott. WC 503 <i>with spring and wc turn 503</i>	•	•	1
	142 RW Q86	Maniglia con rosetta <i>Lever handle on rose</i>	Q86 mm 50x50	con molla e nott. WC 503 <i>with spring and wc turn 503</i>	•	•	1
MARTELLINA / WINDOW HANDLE WITHOUT MECHANISM				€	€		
	142 SE Q13*	Martellina con placca <i>Martellina on plate</i>	Q13 mm 160x33	coprivite q.7 <i>with cov.scr.plate and sq-pin mm 7</i>	•	•	2
	142 SE Q90*	Martellina con placca <i>Martellina on plate</i>	Q90 mm 190x38	coprivite q.7 <i>with cov.scr.plate and sq-pin mm 7</i>	•	•	2
CREMONESE / WINDOW HANDLE WITH MECHANISM				€	€		
	142 SG Q13*	Cremonese con placca <i>Cremon on plate</i>	Q13 mm 160x33	coprivite con gioco <i>with cover-screw plate with mechanism</i>	•	•	2
	142 SG Q90*	Cremonese con placca <i>Cremon on plate</i>	Q90 mm 190x38	coprivite con gioco <i>with cover-screw plate with mechanism</i>	•	•	2
DREH KIPP / DREH KIPP				€	€		
	142 DK C70	Dreh kipp con rosetta <i>Safety DK on rose</i>	C70 mm 69x33	con chiave, cilindro e mov. in metallo <i>with key-cylinder and metal mechanism</i>	•	•	1
	142 DK Q15	Dreh kipp con rosetta <i>Dreh Kipp on rose</i>	Q15 mm 65x31	con movimento in metallo <i>with metal mechanism</i>	•	•	3
	142 DK Q75	Dreh kipp con rosetta <i>Dreh Kipp on rose</i>	Q75 mm 64x30	con mov. securblock e puls. di sicurezza <i>with securblock system and push button</i>	•	•	2

* Placca adatta a movimenti intercambiabili
Plate suitable to interchangeable movements

Per caratteristiche tecniche rosette vedi apposito capitolo soluzioni tecniche e componenti / For technical specifications rosettes see specific section technical solutions and components

A RICHIESTA / ON REQUEST:

- Mezza maniglia con placca o con rosetta (specificare se destra o sinistra) / Half lever handle on plate or on rose (to specify if right or left)
- Maniglia con rosette senza bocchette / Lever handle on rose without rose for key
- Coppie impugnature (CM) con grano e ferro senza rosette e senza bocchette / Pair levers (CM) with grub screws and square pin without rose and without rose for key

art. 142 Q-MINI

design: St. Reguitti - Mod.Dep.
materiale: Impugnatura Zama
material: Lever Zamak

TeKnoMetal
Linea in zama

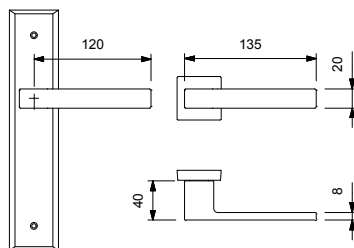

142 MR 816 - ZCR



142 DK 015 - ZSC









142 MR 916 - ZSC

VERSIONI / VERSIONS



Finiture
Finishes

MANIGLIA CON ROSETTA / LEVER HANDLE ON ROSE		ZCR	ZSC	SNV	
		€	€	€	
	142 MR 416 Maniglia con rosetta Lever handle on rose	416 mm Ø45x9	con molla with spring	•	1
	142 MR 816 Maniglia con rosetta Lever handle on rose	816 mm Ø50x10	con molla with spring	•	1
	142 MR 916 Maniglia con rosetta Lever handle on rose	916 mm 62x32	ovale con molla oval with spring	•	1
DREH KIPP / DREH KIPP		€	€	€	
	142 DK 015 Dreh kipp con rosetta Dreh Kipp on rose	015 mm 65x31	con movimento in metallo with metal mechanism	•	3
	142 DK 075 Dreh kipp con rosetta Dreh Kipp on rose	075 mm 64x30	con mov. securblock e puls. di sicurezza with securblock system and push button	•	2
MARTELLINA / WINDOW HANDLE WITHOUT MECHANISM		€	€	€	
	142 SE 070* Martellina con placca Martellina on plate	070 mm 189x36	coprivite q.7 with cover-screw plate and sq.-pin mm 7	•	2
CREMONESE / WINDOW HANDLE WITH MECHANISM		€	€	€	
	142 SG 070* Cremonese con placca Cremon on plate	070 mm 189x36	coprivite con gioco with cover-screw plate with mechanism	•	2

* Placca adatta a movimenti intercambiabili
Plate suitable to interchangeable movements

A RICHIESTA / ON REQUEST:

- Mezza maniglia con placca o con rosetta (specificare se destra o sinistra) / Half lever handle on plate or on rose (to specify if right or left)
- Maniglia con rosette senza bocchette / Lever handle on rose without rose for key
- Coppie impugnature (CM) con grano e ferro senza rosette e senza bocchette / Pair levers (CM) with grub screws and square pin without rose and without rose for key

art. 143 B-MINI

design: St. Reguitti - Mod.Dep.
materiale: Impugnatura Zama
material: Lever Zamak

TeKnoMetal
Linea in zama

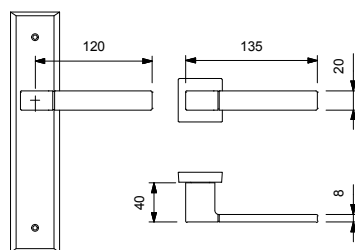

143 MR 416 - ZSC/ZCR



143 DK 015 - ZSC/ZCR



143 MR 916 - ZSC/ZCR

VERSIONI / VERSIONS



Finiture
Finishes



ZSC/ZCR



MANIGLIA CON ROSETTA / LEVER HANDLE ON ROSE

				€	
	 143 MR 416	Maniglia con rosetta Lever handle on rose	416 mm Ø45x9	con molla with spring	• 1
	 143 MR 816	Maniglia con rosetta Lever handle on rose	816 mm Ø50x10	con molla with spring	• 1
	 143 MR 916	Maniglia con rosetta Lever handle on rose	916 mm 62x32	ovale con molla oval with spring	• 1

DREH KIPP / DREH KIPP

				€	
	143 DK 015	Dreh kipp con rosetta Dreh Kipp on rose	015 mm 65x31	con movimento in metallo with metal mechanism	• 3
	143 DK 075	Dreh kipp con rosetta Dreh Kipp on rose	075 mm 64x30	con mov. securblock e puls. di sicurezza with securblock system and push button	• 2

MARTELLINA / WINDOW HANDLE WITHOUT MECHANISM

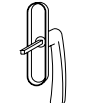
				€	
	143 SE 070*	Martellina con placca Martellina on plate	070 mm 189x36	coprivate q.7 with cover-screw plate and sq.-pin mm 7	• 2

CREMONESE / WINDOW HANDLE WITH MECHANISM

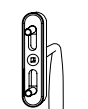
				€	
	143 SG 070*	Cremonese con placca Cremon on plate	070 mm 189x36	coprivate con gioco with cover-screw plate with mechanism	• 2

* Placca adatta a movimenti intercambiabili
Plate suitable to interchangeable movements

A RICHIESTA / ON REQUEST:

- Mezza maniglia con placca o con rosetta (specificare se destra o sinistra) / Half lever handle on plate or on rose (to specify if right or left)
- Maniglia con rosette senza bocchette / Lever handle on rose without rose for key
- Coppie impugnature (CM) con grano e ferro senza rosette e senza bocchette / Pair levers (CM) with grub screws and square pin without rose and without rose for key







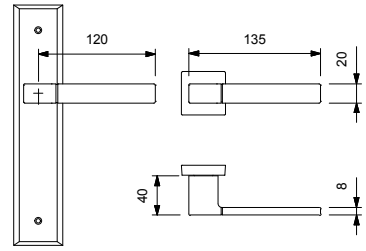



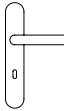

art. 143 B-MINI

design: St. Reguitti - Mod.Dep.
 materiale: Impugnatura Zama
 material: Lever Zamak

TeKnoMetal
 Linea in zama





MANIGLIA CON PLACCA / LEVER HANDLE ON PLATE				€
	143 MP 130	Maniglia con placca <i>Lever handle on plate</i>	130 mm 245x50 con molla <i>with spring</i>	• 1
MANIGLIA CON ROSETTA / LEVER HANDLE ON ROSE				€
	143 MR 9Q6	Maniglia con rosetta <i>Lever handle on rose</i>	9Q6 mm 61x31 con molla <i>with spring</i>	• 1
	143 MR Q46	Maniglia con rosetta <i>Lever handle on rose</i>	Q46 mm 45x45 con molla <i>with spring</i>	• 1
	143MRQ56-71	Maniglia con rosetta <i>Lever handle on rose</i>	Q56 mm 50x50 Base in metallo con molla e bocc. Q08 <i>Internal metal - spring and Q08 key rose</i>	• 1
	143 MR Q86	Maniglia con rosetta <i>Lever handle on rose</i>	Q86 mm 50x50 con molla <i>with spring</i>	• 1
MANIGLIA CON ROSETTA E NOTTOLINO WC / LEVER HANDLE ON ROSE AND WC TURN				€
	143 RQ Q46	Maniglia con rosetta <i>Lever handle on rose</i>	Q46 mm 45x45 con molla e nott. wc 124 <i>with spring and wc turn 124</i>	• 1
	143 RQ Q86	Maniglia con rosetta <i>Lever handle on rose</i>	Q86 mm 50x50 con molla e nott. wc 124 <i>with spring and wc turn 124</i>	• 1
MANIGLIA CON ROSETTA E NOTTOLINO WC / LEVER HANDLE ON ROSE AND WC TURN				€
	143 RW Q46	Maniglia con rosetta <i>Lever handle on rose</i>	Q46 mm 45x45 con molla e nott. WC 503 <i>with spring and wc turn 503</i>	• 1
	143 RW Q86	Maniglia con rosetta <i>Lever handle on rose</i>	Q86 mm 50x50 con molla e nott. WC 503 <i>with spring and wc turn 503</i>	• 1
MARTELLINA / WINDOW HANDLE WITHOUT MECHANISM				€
	143 SE Q13*	Martellina con placca <i>Martellina on plate</i>	Q13 mm 160x33 coprivate q.7 <i>with cov.scr.plate and sq-pin mm 7</i>	• 2
	143 SE Q90*	Martellina con placca <i>Martellina on plate</i>	Q90 mm 190x38 coprivate q.7 <i>with cov.scr.plate and sq-pin mm 7</i>	• 2
CREMONESE / WINDOW HANDLE WITH MECHANISM				€
	143 SG Q13*	Cremonese con placca <i>Cremon on plate</i>	Q13 mm 160x33 coprivate con gioco <i>with cover-screw plate with mechanism</i>	• 2
	143 SG Q90*	Cremonese con placca <i>Cremon on plate</i>	Q90 mm 190x38 coprivate con gioco <i>with cover-screw plate with mechanism</i>	• 2
DREH KIPP / DREH KIPP				€
	143 DK C70	Dreh kipp con rosetta <i>Safety DK on rose</i>	C70 mm 69x33 con chiave, cilindro e mov. in metallo <i>with key-cylinder and metal mechanism</i>	• 1
	143 DK Q15	Dreh kipp con rosetta <i>Dreh Kipp on rose</i>	Q15 mm 65x31 con movimento in metallo <i>with metal mechanism</i>	• 3
	143 DK Q75	Dreh kipp con rosetta <i>Dreh Kipp on rose</i>	Q75 mm 64x30 con mov. securblock e puls. di sicurezza <i>with securblock system and push button</i>	• 2

* Placca adatta a movimenti intercambiabili
Plate suitable to interchangeable movements

Per caratteristiche tecniche rosette vedi apposito capitolo soluzioni tecniche e componenti / For technical specifications rosettes see specific section technical solutions and components

A RICHIESTA / ON REQUEST:

- Mezza maniglia con placca o con rosetta (specificare se destra o sinistra) / Half lever handle on plate or on rose (to specify if right or left)
- Maniglia con rosette senza bocchette / Lever handle on rose without rose for key
- Coppie impugnature (CM) con grano e ferro senza rosette e senza bocchette / Pair levers (CM) with grub screws and square pin without rose and without rose for key

art. 144 QUARK

design: Studio Reguitti
 materiale: Impugnatura Zama
 material: Lever Zamak

TeKnoMetal
 Linea in zama

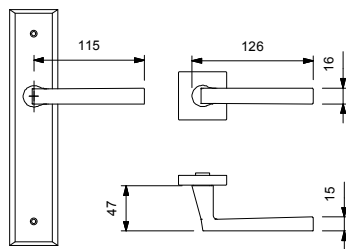

144 MR 005 - ZSC



144 MP 130 - ZSC



sottorosetta in metallo
 collare a vista finito
Internal metal rose

144 MR Q05 - ZSC



sottorosetta in nylon
 senza parti nylon a vista
internal concealed nylon rose

144 MR Q46 - ZSC



sottorosetta in nylon
 collare a vista grigio
Internal visible nylon rose

144 MR Q08 - ZSC



144 SE Q90 - ZSC
 144 SG Q90 - ZSC



144 DK 015 - ZSC



144 DK Q15 - ZSC

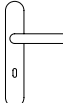

MANIGLIA CON PLACCA / LEVER HANDLE ON PLATE

				€	€		
	144 MP 130	Maniglia con placca Lever handle on plate	130 mm 245x50	con molla with spring	•	•	1
	144 MP 188	Maniglia con placca Lever handle on plate	188 mm 255x42	con molla with spring	•	•	1

MANIGLIA CON ROSETTA / LEVER HANDLE ON ROSE

					€	€	
	144 MR 005	Maniglia con rosetta Lever handle on rose	005 mm Ø50x8	tipo lusso con molla lusso type with spring	•	•	1
	144 MR 416	Maniglia con rosetta Lever handle on rose	416 mm Ø45x9	con molla with spring	•	•	1
	144 MR 916	Maniglia con rosetta Lever handle on rose	916 mm 62x32	ovale con molla oval with spring	•	•	1
	144 MR 9Q6	Maniglia con rosetta Lever handle on rose	9Q6 mm 61x31	con molla with spring	•	•	1
	144MRQ05-71	Maniglia con rosetta Lever handle on rose	Q05 mm 50x50	Base in metallo con molla e bocc. Q08 Internal metal - spring and Q08 key rose	•	•	1
	144 MR Q08	Maniglia con rosetta Lever handle on rose	Q08 mm 50x50	con molla with spring	•	•	1
	144 MR Q46	Maniglia con rosetta Lever handle on rose	Q46 mm 45x45	con molla with spring	•	•	1

MARTELLINA / WINDOW HANDLE WITHOUT MECHANISM

					€	€	
	144 SE 070*	Martellina con placca Martellina on plate	070 mm 189x36	coprivite q.7 with cover-screw plate and sq.-pin mm 7	•	•	2
	144 SE Q13*	Martellina con placca Martellina on plate	Q13 mm 160x33	coprivite q.7 with cov.scr.plate and sq.-pin mm 7	•	•	2
	144 SE Q90*	Martellina con placca Martellina on plate	Q90 mm 190x38	coprivite q.7 with cov.scr.plate and sq.-pin mm 7	•	•	2

CREMONESE / WINDOW HANDLE WITH MECHANISM

					€	€	
	144 SG 070*	Cremonese con placca Cremon on plate	070 mm 189x36	coprivite con gioco with cover-screw plate with mechanism	•	•	2
	144 SG Q13*	Cremonese con placca Cremon on plate	Q13 mm 160x33	coprivite con gioco with cover-screw plate with mechanism	•	•	2
	144 SG Q90*	Cremonese con placca Cremon on plate	Q90 mm 190x38	coprivite con gioco with cover-screw plate with mechanism	•	•	2

DREH KIPP / DREH KIPP

					€	€	
	144 DK 015	Dreh kipp con rosetta Dreh Kipp on rose	015 mm 65x31	con movimento in metallo with metal mechanism	•	•	3
	144 DK Q15	Dreh kipp con rosetta Dreh Kipp on rose	Q15 mm 65x31	con movimento in metallo with metal mechanism	•	•	3

* Placca adatta a movimenti intercambiabili
Plate suitable to interchangeable movements

Per caratteristiche tecniche rosette vedi apposito capitolo soluzioni tecniche e componenti / For technical specifications rosettes see specific section technical solutions and components

A RICHIESTA / ON REQUEST:

- Mezza maniglia con placca o con rosetta (specificare se destra o sinistra) / Half lever handle on plate or on rose (to specify if right or left)
- Maniglia con rosette senza bocchette / Lever handle on rose without rose for key
- Coppie impugnature (CM) con grano e ferro senza rosette e senza bocchette / Pair levers (CM) with grub screws and square pin without rose and without rose for key

art. 145 INMA

design: Studio Reguitti
 materiale: Impugnatura Zama
 material: Lever Zamak

TeKnoMetal
 Linea in zama

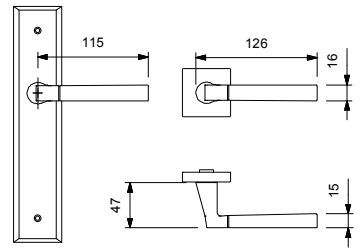

145 MR Q08 - ZSC/ZCR/OSC



145 MP 130 - ZSC/ZCR/OSC



145 MR Q46 - ZSC/ZCR



145 MR 9Q6 - ZSC/ZCR



145 MR 416 - ZSC/ZCR/OSC



145 MR 916 - ZSC/ZCR



145 SE Q13 - ZSC/ZCR
 145 SG Q13 - ZSC/ZCR



145 DK 015 - ZSC/ZCR



145 DK Q15 - ZSC/ZCR/OSC



MANIGLIA CON PLACCA / LEVER HANDLE ON PLATE

				€		
	145 MP 130	Maniglia con placca <i>Lever handle on plate</i>	130 mm 245x50	con molla <i>with spring</i>	•	1
	145 MP 188	Maniglia con placca <i>Lever handle on plate</i>	188 mm 255x42	con molla <i>with spring</i>	•	1

MANIGLIA CON ROSETTA / LEVER HANDLE ON ROSE

				€		
	145 MR 005	Maniglia con rosetta <i>Lever handle on rose</i>	005 mm Ø50x8	tipo lusso con molla <i>lusso type with spring</i>	•	1
	145 MR 416	Maniglia con rosetta <i>Lever handle on rose</i>	416 mm Ø45x9	con molla <i>with spring</i>	•	1
	145 MR 916	Maniglia con rosetta <i>Lever handle on rose</i>	916 mm 62x32	ovale con molla <i>oval with spring</i>	•	1
	145 MR 9Q6	Maniglia con rosetta <i>Lever handle on rose</i>	9Q6 mm 61x31	con molla <i>with spring</i>	•	1
	145MRQ05-71	Maniglia con rosetta <i>Lever handle on rose</i>	Q05 mm 50x50	Base in metallo con molla e bocc. Q08 <i>Internal metal - spring and Q08 key rose</i>	•	1
	145 MR Q08	Maniglia con rosetta <i>Lever handle on rose</i>	Q08 mm 50x50	con molla <i>with spring</i>	•	1
	145 MR Q46	Maniglia con rosetta <i>Lever handle on rose</i>	Q46 mm 45x45	con molla <i>with spring</i>	•	1

MARTELLINA / WINDOW HANDLE WITHOUT MECHANISM

				€		
	145 SE 070*	Martellina con placca <i>Martellina on plate</i>	070 mm 189x36	coprivite q.7 <i>with cover-screw plate and sq.-pin mm 7</i>	•	2
	145 SE Q13*	Martellina con placca <i>Martellina on plate</i>	Q13 mm 160x33	coprivite q.7 <i>with cov.scr.plate and sq.-pin mm 7</i>	•	2
	145 SE Q90*	Martellina con placca <i>Martellina on plate</i>	Q90 mm 190x38	coprivite q.7 <i>with cov.scr.plate and sq.-pin mm 7</i>	•	2

CREMONESE / WINDOW HANDLE WITH MECHANISM

				€		
	145 SG 070*	Cremonese con placca <i>Cremon on plate</i>	070 mm 189x36	coprivite con gioco <i>with cover-screw plate with mechanism</i>	•	2
	145 SG Q13*	Cremonese con placca <i>Cremon on plate</i>	Q13 mm 160x33	coprivite con gioco <i>with cover-screw plate with mechanism</i>	•	2
	145 SG Q90*	Cremonese con placca <i>Cremon on plate</i>	Q90 mm 190x38	coprivite con gioco <i>with cover-screw plate with mechanism</i>	•	2

DREH KIPP / DREH KIPP

				€		
	145 DK 015	Dreh kipp con rosetta <i>Dreh Kipp on rose</i>	015 mm 65x31	con movimento in metallo <i>with metal mechanism</i>	•	3
	145 DK Q15	Dreh kipp con rosetta <i>Dreh Kipp on rose</i>	Q15 mm 65x31	con movimento in metallo <i>with metal mechanism</i>	•	3

* Placca adatta a movimenti intercambiabili
Plate suitable to interchangeable movements

Per caratteristiche tecniche rosette vedi apposito capitolo soluzioni tecniche e componenti / For technical specifications rosettes see specific section technical solutions and components

A RICHIESTA / ON REQUEST:

- Mezza maniglia con placca o con rosetta (specificare se destra o sinistra) / Half lever handle on plate or on rose (to specify if right or left)
- Maniglia con rosette senza bocchette / Lever handle on rose without rose for key
- Coppie impugnature (CM) con grano e ferro senza rosette e senza bocchette / Pair levers (CM) with grub screws and square pin without rose and without rose for key

art. 151 FEDE

design: Studio Reguitti
 materiale: Ottone
 material: Solid Brass

Brass Class
 100% Ottone

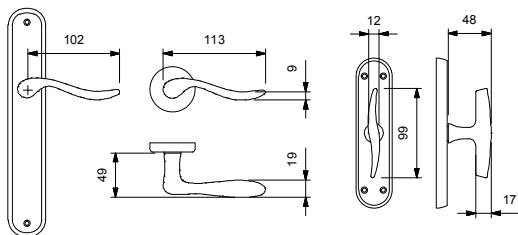

151 MR 006 - OSC



151 MP 039 - OC



151 MP 188 - OSC



151 MP 026 - BG



151 MR 009 - OSC



151 MR 004 - LV



151 CR 137 - OSC
 151 MA 137 - OSC

destro / right







151 DK 015 - OC

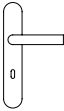

151 MA 007 - OSC

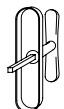
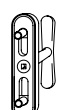

MANIGLIA CON PLACCA / LEVER HANDLE ON PLATE				€	€	€	€	€
	151 MP 026	Maniglia con placca Lever handle on plate	026 mm 225x26 "stretta" "reduced"	•	•	•	•	• 1
	151 MP 039	Maniglia con placca Lever handle on plate	039 mm 255x50 con molla with spring	•	•	•	•	• 1
	151 MP 040	Maniglia con placca Lever handle on plate	040 mm 244x40 con molla with spring	•	•	•	•	• 1
	151 MP 188	Maniglia con placca Lever handle on plate	188 mm 255x42 con molla with spring	•	•	•	•	• 1
MANIGLIA CON ROSETTA / LEVER HANDLE ON ROSE				€	€	€	€	€
	151 MR 004	Maniglia con rosetta Lever handle on rose	004 mm Ø45x9 con molla with spring	•	•	•	•	• 2
	151 MR 006	Maniglia con rosetta Lever handle on rose	006 mm Ø50x8 tipo lusso con molla lusso type with spring	•	•	•	•	• 2
	151 MR 007	Maniglia con rosetta Lever handle on rose	007 mm 67x27 ovale stretta oval and reduced	•	•	•	•	• 2
	151 MR 009	Maniglia con rosetta Lever handle on rose	009 mm 62x32 ovale con molla oval with spring	•	•	•	•	• 1
MARTELLINA / WINDOW HANDLE WITHOUT MECHANISM				€	€	€	€	€
	151 MA 007	Martellina su rosetta Martellina on rose	007 mm 67x27 q.7 with square-pin mm 7	•	•	•	•	• 2
	151 MA 040*	Martellina su placca Martellina on plate	040 mm 174x37 q.7 with square-pin mm 7	•	•	•	•	• 2
	151 MA 137*	Martellina su placca Martellina on plate	137 mm 167x40 q.7 with square-pin mm 7	•	•	•	•	• 2
CREMONESE / WINDOW HANDLE WITH MECHANISM				€	€	€	€	€
	151 CR 040*	Cremonese con placca Cremon on plate	040 mm 174x37 con gioco with mechanism	•	•	•	•	• 2
	151 CR 137*	Cremonese con placca Cremon on plate	137 mm 167x40 con gioco with mechanism	•	•	•	•	• 2
DREH KIPP / DREH KIPP				€	€	€	€	€
	151 DK 015	Dreh kipp (destra) con rosetta Dreh Kipp (right) on rose	015 mm 65x31 con movimento in metallo with metal mechanism	•	•	•	•	• 3
	151 DK 075	Dreh kipp (destra) con rosetta Dreh Kipp (right) on rose	075 mm 64x30 con mov. securblock e puls. di sicurezza with securblock system and push button	•	•	•	•	• 2

* Placca adatta a movimenti intercambiabili
Plate suitable to interchangeable movements

Per caratteristiche tecniche rosette vedi apposito capitolo soluzioni tecniche e componenti / For technical specifications rosettes see specific section technical solutions and components

A RICHIESTA / ON REQUEST:

- Mezza maniglia con placca o con rosetta (specificare se destra o sinistra) / Half lever handle on plate or on rose (to specify if right or left)
- Maniglia con rosette senza bocchette / Lever handle on rose without rose for key
- Coppie impugnature (CM) con grano e ferro senza rosette e senza bocchette / Pair levers (CM) with grub screws and square pin without rose and without rose for key

art. 159 DANIA

materiale: Ottone
material: Solid Brass

Brass Class
100% Ottone

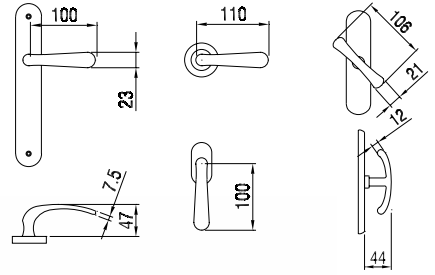

159 MR 003 LV



159 MR 007 LV



159 MR 416 OSC



159 MR 003 OS



159 MR 003 OSC



159 MR 003 OC



159 MR 003 BG



159 MP 159 LV



159 MA 137 LV
159 CR 137 LV



159 DK 015 LV
159 DK 024 LV

VERSIONI / VERSIONS



Finiture
Finishes

					LV OS	BG	OSC OC	
MANIGLIA CON PLACCA / LEVER HANDLE ON PLATE								
	159 MP 159	Maniglia con placca Lever Handle on plate	159	mm 231x35	con molla with spring		•	3
	159 MP 159	Maniglia con placca Lever Handle on plate	159	mm 231x35	con molla e grano with spring and grub screw		•	3
	159 PW 159	Maniglia con placca Lever Handle on plate	159	mm 231x35	con WC 503 con molla with WC turn 503 with spring		•	3
	159 PW 159	Maniglia con placca Lever Handle on plate	159	mm 231x35	con WC 503 con molla e grano with WC turn 503 with spring and grub screw		•	3
MANIGLIA CON ROSETTA / LEVER HANDLE ON ROSE								
	159 MR 003	Maniglia con rosetta Lever Handle on rose	003	mm Ø45x7	con molla e grano with spring and grub screw		•	5
	159 MR 006	Maniglia con rosetta Lever Handle on rose	006	mm Ø50x8	tipo lusso con molla e grano lusso type with spring and grub screw		•	2
	159 MR 007	Maniglia con rosetta Lever Handle on rose	007	mm 67x27	ovale stretta con grano oval and reduced with grub screw		•	5
	159 MR 009	Maniglia con rosetta Lever Handle on rose	009	mm 62x32	ovale con molla e grano oval with spring and grub screw		•	1
	159 MR 416	Maniglia con rosetta Lever Handle on rose	416	mm Ø45x9	con molla e grano with spring and grub screw		•	5
	159 RW 003	Maniglia con rosetta Lever Handle on rose	003	mm Ø45x7	con WC 503 con Wc turn 503		•	1
	159 RW 006	Maniglia con rosetta Lever Handle on rose	006	mm Ø50x8	tipo lusso con WC 503 lusso type with WC turn 503		•	1
CREMONESE / WINDOW HANDLE WITH MECHANISM								
	159 CR 137*	Cremonese con placca Window Handle on plate	137	mm 167x40	con fori viti con gioco with holes for screws with mechanism		•	6
MARTELLINA / WINDOW HANDLE WITHOUT MECHANISM								
	159 MA 137*	Martellina con placca Window Handle on plate	137	mm 167x40	con fori viti q.7 with holes for screws with square-pin mm 7		•	6
	159 MA 007	Martellina con rosetta Window Handle on rose	007	mm 67x27	q.7 without mechanism with square-pin mm 7		•	6
DREH KIPP / DREH KIPP								
	159 DK 015	Dreh Kipp con rosetta Dreh Kipp on rose	015	mm 65x31	con movimento in metallo with metal mechanism		•	6
	159 DK 024	Dreh Kipp con rosetta Dreh Kipp on rose	024	mm 65x31	c/mov. in metallo e quadro autoregolante with metal mec. and adjustable square-pin		•	6
	159 DK 075	Dreh Kipp con rosetta Safety DK on rose	075	mm 64x30	con mov. securblock e pulsante di sicurezza with securblock system and push button		•	2

* Placca adatta a movimenti intercambiabili
Plate suitable to interchangeable movements

Per caratteristiche tecniche rosette vedi apposito capitolo soluzioni tecniche e componenti / For technical specifications rosettes see specific section technical solutions and components

A RICHIESTA / ON REQUEST:

- Mezza maniglia con placca o con rosetta (specificare se destra o sinistra) / Half lever handle on plate or on rose (to specify if right or left)
- Maniglia con rosette senza bocchette / Lever handle on rose without rose for key
- Coppie impugnature (CM) con grano e ferro senza rosette e senza bocchette / Pair levers (CM) with grub screws and square pin without rose and without rose for key
- Cremonesi e martelline con impugnatura a maniglia (segretini)
- Cremonese e martellina con placca coprivite e movimento intercambiabile

art. 150 C-PLUS

design: Studio Reguitti
materiale: Ottone - Alluminio
material: Solid Brass - Aluminium

Brass Class
100% Ottone



150 MR 006 AA/OC



150 MR 816 AA/OC



150 MR 416 AA/OC

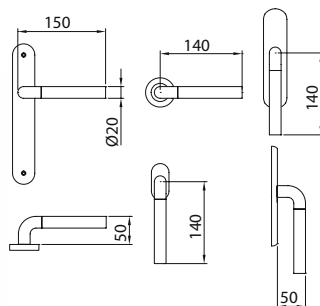

150 DK 015 AA/OC

VERSIONI / VERSIONS



Furniture Finishes

MANIGLIA CON PLACCA / LEVER HANDLE ON PLATE

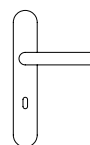

150 MP 188 Maniglia con placca 188 mm 255x42 con molla e grano
Lever Handle on plate with spring and grub screw

AA/OC 

• 1

MANIGLIA CON ROSETTA / LEVER HANDLE ON ROSE

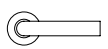

150 MR 006 Maniglia con rosetta 006 mm Ø50x8 tipo lusso con molla e grano
Lever Handle on rose lusso type with spring and grub screw

• 1



150 MR 416 Maniglia con rosetta 416 mm Ø45x9 con molla e grano
Lever Handle on rose with spring and grub screw

• 1



150 MR 816 Maniglia con rosetta 816 mm Ø50x10 con molla e grano
Lever Handle on rose with spring and grub screw

• 1

CREMONESE / WINDOW HANDLE WITH MECHANISM



150 SG 070* Cremonese con placca 070 mm 189x36 coprivite con gioco
Window Handle on plate with cover-screw plate with mechanism

• 2

MARTELLINA / WINDOW HANDLE WITHOUT MECHANISM



150 SE 070* Martellina con placca 070 mm 189x36 coprivite q.7
Window Handle on plate with cover-screw plate with square-pin mm 7

• 2

DREH KIPP / DREH KIPP



150 DK 015 Dreh Kipp con rosetta 015 mm 65x31 con movimento in metallo
Dreh Kipp on rose with metal mechanism

• 3

* Placca adatta a movimenti intercambiabili - Plate suitable to interchangeable movements

Per caratteristiche tecniche rosette vedi apposito capitolo soluzioni tecniche e componenti / For technical specifications rosettes see specific section technical solutions and components

A RICHIESTA / ON REQUEST:

- Mezza maniglia con placca o con rosetta (specificare se destra o sinistra) / Half lever handle on plate or on rose (to specify if right or left)
- Maniglia con rosette senza bocchette / Lever handle on rose without rose for key
- Coppie impugnature (CM) con grano e ferro senza rosette e senza bocchette / Pair levers (CM) with grub screws and square pin without rose and without rose for key

art. 164 FUTURA

design: Studio Reguitti
materiale: Ottone
material: Solid Brass

Brass Class
100% Ottone



164 MP 037 LV



164 MR 006 OS/LV



164 MR 416 OSC/OC



164 MR 006 OSC/OC

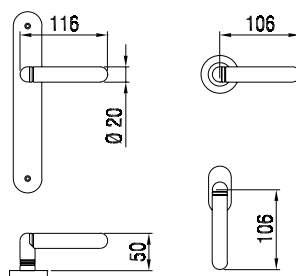



164 DK 015 LV

VERSIONI / VERSIONS



Finiture
Finishes

	LV OS/LV	OSC OC	OSC/OC OC/LV NR/OC NR/LV	
MANIGLIA CON PLACCA / LEVER HANDLE ON PLATE				
164 MP 037 Maniglia con placca / Lever Handle on plate 037 mm 255x42 con molla e grano / with spring and grub screw	•	•	•	1
164 PW 037 Maniglia con placca / Lever Handle on plate 037 mm 255x42 con WC 503 con molla e grano / with WC turn 503 with spring and grub screw	•	•	•	1
MANIGLIA CON ROSETTA / LEVER HANDLE ON ROSE				
164 MR 006 Maniglia con rosetta / Lever Handle on rose 006 mm Ø50x8 tipo lusso con molla e grano / lusso type with spring and grub screw	•	•	•	1
 164 MR 416 Maniglia con rosetta / Lever Handle on rose 416 mm Ø45x9 con molla e grano / with spring and grub screw	•	•	•	1
164 RW 006 Maniglia con rosetta / Lever Handle on rose 006 mm Ø50x8 tipo lusso con WC 503 / lusso type with WC turn 503	•	•	•	1
 164 RW 416 Maniglia con rosetta / Lever Handle on rose 416 mm Ø45x9 con WC 503 / with WC turn 503	•	•	•	1
CREMONESE / WINDOW HANDLE WITH MECHANISM				
164 CR 137 Cremonese con placca / Window Handle on plate 137 mm 167x40 con fori viti con gioco / with holes for screws with mechanism	•	•	•	2
164 CR 070* Cremonese con placca / Window Handle on plate 070 mm 189x36 coprivite con gioco / with cover-screw plate with mechanism	•	•	•	2
MARTELLINA / WINDOW HANDLE WITHOUT MECHANISM				
164 MA 137 Martellina con placca / Window Handle on plate 137 mm 167x40 con fori viti q. 7 mm / with holes for screws with square-pin mm 7	•	•	•	2
164 MA 070* Martellina con placca / Window Handle on plate 070 mm 189x36 coprivite q. 7 mm / with cover-screw plate with square-pin mm 7	•	•	•	2
DREH KIPP / DREH KIPP				
164 DK 015 Dreh Kipp con rosetta / Dreh Kipp on rose 015 mm 65x31 con movimento in metallo / with metal mechanism	•	•	•	3

* Placca adatta a movimenti intercambiabili - Plate suitable to interchangeable movements

Per caratteristiche tecniche rosette vedi apposito capitolo soluzioni tecniche e componenti / For technical specifications rosettes see specific section technical solutions and components

A RICHIESTA / ON REQUEST:

- Mezza maniglia con placca o con rosetta (specificare se destra o sinistra) / Half lever handle on plate or on rose (to specify if right or left)
- Maniglia con rosette senza bocchette / Lever handle on rose without rose for key
- Coppie impugnature (CM) con grano e ferro senza rosette e senza bocchette / Pair levers (CM) with grub screws and square pin without rose and without rose for key

art. 166 PRAGA

materiale: Ottone
material: Solid Brass

Brass Class
100% Ottone

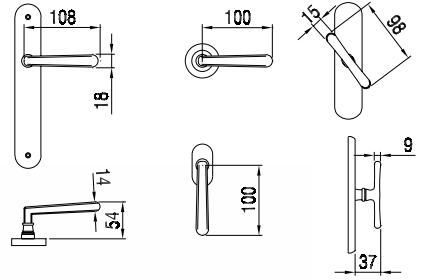

166 MR 202 LV



166 MR 004 LV



166 MR 007 LV



166 MR 004 AN



166 MR 202 AN



166 MR 202 AGV



166 MP 166 LV



166 MA 040 LV
166 CR 040 LV



166 MA 007 LV



166 DK 015 LV



					LV	AN	AGV	
MANIGLIA CON PLACCA / LEVER HANDLE ON PLATE								
	166 MP 166	Maniglia con placca Lever Handle on plate	166 mm 242x33	con molla e grano with spring and grub screw	•	•	•	1
	166 MP 026	Maniglia con placca Lever Handle on plate	026 mm 225x26	stretta con grano reduced with grub screw	•	•	•	1
MANIGLIA CON ROSETTA / LEVER HANDLE ON ROSE								
	166 MR 003	Maniglia con rosetta Lever Handle on rose	003 mm Ø45x7	con molla e grano with spring and grub screw			•	2
	166 MR 004	Maniglia con rosetta Lever Handle on rose	004 mm Ø45x9	con molla e grano with spring and grub screw	•	•		2
	166 MR 007	Maniglia con rosetta Lever Handle on rose	007 mm 67x27	ovale stretta con grano oval and reduced with grub screw	•	•	•	2
	166 MR 202	Maniglia con rosetta Lever Handle on rose	202 mm Ø52x9	con bordo con grano with edge with grub screw	•	•	•	2
CREMONESE / WINDOW HANDLE WITH MECHANISM								
	166 CR 040*	Cremonese con placca Window Handle on plate	040 mm 174x37	con gioco with mechanism	•	•	•	2
MARTELLINA / WINDOW HANDLE WITHOUT MECHANISM								
	166 MA 040*	Martellina con placca Window Handle on plate	040 mm 174x37	q.7 without mechanism with square-pin mm 7	•	•	•	2
	166 MA 007	Martellina con rosetta Window Handle on rose	007 mm 67x27	q.7 without mechanism with square-pin mm 7	•	•	•	4
DREH KIPP / DREH KIPP								
	166 DK 015	Dreh Kipp con rosetta Dreh Kipp on rose	015 mm 65x31	con movimento in metallo with metal mechanism	•	•	•	3

* Placca adatta a movimenti intercambiabili
Plate suitable to interchangeable movements



166 MP 166 AN

Per caratteristiche tecniche rosette vedi apposito capitolo soluzioni tecniche e componenti / For technical specifications rosettes see specific section technical solutions and components

A RICHIESTA / ON REQUEST:

- Mezza maniglia con placca o con rosetta (specificare se destra o sinistra) / Half lever handle on plate or on rose (to specify if right or left)
- Maniglia con rosette senza bocchette / Lever handle on rose without rose for key
- Coppie impugnature (CM) con grano e ferro senza rosette e senza bocchette / Pair levers (CM) with grub screws and square pin without rose and without rose for key
- Cremonesi e martelline con impugnatura a maniglia (segretini)
- Cremonese e martellina con placca coprivite e movimento intercambiabile

art. 167 VIENNA

materiale: Ottone
material: Solid Brass

Brass Class
100% Ottone

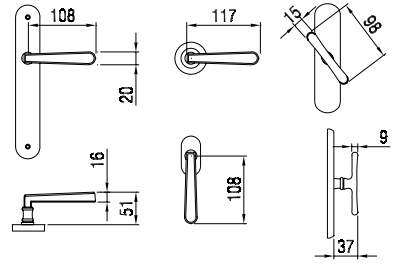



					LV	AN	AGV	
MANIGLIA CON PLACCA / LEVER HANDLE ON PLATE								
	167 MP 039	Maniglia con placca Lever Handle on plate	039 mm 255x50	con molla e grano with spring and grub screw	•	•	•	1
	167 MP 040	Maniglia con placca Lever Handle on plate	040 mm 244x40	con molla e grano with spring and grub screw	•	•	•	1
	167 MP 188	Maniglia con placca Lever Handle on plate	188 mm 255x42	con molla e grano with spring and grub screw	•			1
MANIGLIA CON ROSETTA / LEVER HANDLE ON ROSE								
	167 MR 004	Maniglia con rosetta Lever Handle on rose	004 mm Ø45x9	con molla e grano with spring and grub screw	•	•		2
	167 MR 005	Maniglia con rosetta Lever Handle on rose	005 mm Ø50x8	tipo lusso con molla e grano lusso type with spring and grub screw	•			2
	167 MR 202	Maniglia con rosetta Lever Handle on rose	202 mm Ø52x9	con bordo con grano with edge with grub screw	•	•	•	2
	167 MR 008	Maniglia con rosetta Lever Handle on rose	008 mm Ø50x8	con molla e grano with spring and grub screw	•			2
CREMONESE / WINDOW HANDLE WITH MECHANISM								
	167 CR 040*	Cremonese con placca Window Handle on plate	040 mm 174x37	con gioco with mechanism	•	•	•	2
	167 CR 137*	Cremonese con placca Window Handle on plate	137 mm 167x40	con fori viti con gioco with holes for screws with mechanism	•			2
MARTELLINA / WINDOW HANDLE WITHOUT MECHANISM								
	167 MA 040*	Martellina con placca Window Handle on plate	040 mm 174x37	q.7 without mechanism with square-pin mm 7	•	•	•	2
	167 MA 137*	Martellina con placca Window Handle on rose	137 mm 167x40	con fori viti q.7 without mechanism with square-pin mm 7	•			2
DREH KIPP / DREH KIPP								
	167 DK 015	Dreh Kipp con rosetta Dreh Kipp on rose	015 mm 65x31	con movimento in metallo with metal mechanism	•	•	•	3

* Placca adatta a movimenti intercambiabili
Plate suitable to interchangeable movements



167 MP 188 LV



167 MP 039 AGV



167 MP 039 AN

Per caratteristiche tecniche rosette vedi apposito capitolo soluzioni tecniche e componenti / For technical specifications rosettes see specific section technical solutions and components

A RICHIESTA / ON REQUEST:

- Mezza maniglia con placca o con rosetta (specificare se destra o sinistra) / Half lever handle on plate or on rose (to specify if right or left)
- Maniglia con rosette senza bocchette / Lever handle on rose without rose for key
- Coppie impugnature (CM) con grano e ferro senza rosette e senza bocchette / Pair levers (CM) with grub screws and square pin without rose and without rose for key
- Cremonesi e martelline con impugnatura a maniglia (segretini)
- Cremonese e martellina con placca coprivite e movimento intercambiabile

art. 171 ALISE'

design: Studio Reguitti
 materiale: Ottone
 material: Solid Brass

Brass Class
 100% Ottone

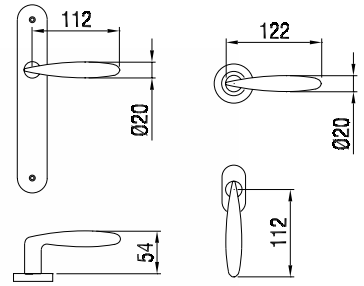

171 MR 006 LV



171 MR 006 OC



171 MR 008 OSC



171 MR 004 BG



171 MR 009 LV



171 MR 416 OSC



171 MR 007 LV



171 SE 070 LV
 171 SG 070 LV



171 MP 188 LV



171 DK 024 LV

VERSIONI / VERSIONS



Finiture
Finishes

						LV	BG	OSC	BGO	
MANIGLIA CON PLACCA / LEVER HANDLE ON PLATE										
	171 MP 188	Maniglia con placca Lever Handle on plate	188	mm 255x42	con molla e grano with spring and grub screw	•	•	•	•	1
	171 MP 026	Maniglia con placca Lever Handle on plate	026	mm 225x26	stretta con grano reduced with grub screw	•	•	•	•	1
	171 MP 248	Maniglia con placca Lever Handle on plate	248	mm 248x50	con molla e grano with spring and grub screw	•	•	•	•	1
MANIGLIA CON ROSETTA / LEVER HANDLE ON ROSE										
	171 MR 004	Maniglia con rosetta Lever Handle on rose	004	mm Ø45x9	con molla e grano with spring and grub screw	•	•	•	•	2
	171 MR 006	Maniglia con rosetta Lever Handle on rose	006	mm Ø50x8	tipo lusso con molla e grano luxury type with spring and grub screw	•	•	•	•	2
	171MR006-61	Maniglia con rosetta Lever Handle on rose	006	mm Ø50x8	lusso con molla e grano con bocchetta 068 luxury type w/spring, grub scr., rose for key 068	•	•	•	•	2
	171MR006-62	Maniglia con rosetta Lever Handle on rose	006	mm Ø50x8	lusso c.molla e grano c. bocchetta 068 yale l.type w/spr., grub scr. - rose for key 068 yale	•	•	•	•	2
	171 MR 007	Maniglia con rosetta Lever Handle on rose	007	mm 67x27	ovale stretta con grano oval and reduced with grub screw	•	•	•	•	2
	171 MR 008	Maniglia con rosetta Lever Handle on rose	008	mm Ø50x8	con molla e grano with spring and grub screw	•	•	•	•	2
	171 MR 009	Maniglia con rosetta Lever Handle on rose	009	mm 62x32	ovale con molla e grano oval with spring and grub screw	•	•	•	•	1
	171 MR 416	Maniglia con rosetta Lever Handle on rose	416	mm Ø45x9	con molla e grano with spring and grub screw	•	•	•	•	1
	171 MR 916	Maniglia con rosetta Lever Handle on rose	916	mm 62x32	ovale con molla e grano oval with spring and grub screw	•	•	•	•	1
CREMONESE / WINDOW HANDLE WITH MECHANISM										
	171 SG 070*	Cremonese con placca Window Handle on plate	070	mm 189x36	coprivite con gioco with cover-screw plate with mechanism	•	•	•	25,80	2
MARTELLINA / WINDOW HANDLE WITHOUT MECHANISM										
	171 SE 070*	Martellina con placca Window Handle on plate	070	mm 189x36	coprivite q.7 with cover-screw plate with square-pin mm 7	•	•	•	25,80	2
DREH KIPP / DREH KIPP										
	171 DK 015	Dreh Kipp con rosetta Dreh Kipp on rose	015	mm 65x31	con movimento in metallo with metal mechanism	•	•	•	•	3
	171 DK 024	Dreh Kipp con rosetta Dreh Kipp on rose	024	mm 65x31	c/mov. in metallo e quadro autoregolante with metal mec. and adjustable square-pin	•	•	•	•	3
	171 DK 074	Dreh Kipp con rosetta Safety DK on rose	074	mm 64x30	con mov. securblock e quadro autoregolante with securblock and adjustable square-pin	•	•	•	•	2

*Placca adatta a movimenti intercambiabili
Plate suitable to interchangeable movements



171 MR 006-61 LV



171 MR 006-62 yale OSC

Per caratteristiche tecniche rosette vedi apposito capitolo soluzioni tecniche e componenti / For technical specifications rosettes see specific section technical solutions and components

A RICHIESTA / ON REQUEST:

- Mezza maniglia con placca o con rosetta (specificare se destra o sinistra) / Half lever handle on plate or on rose (to specify if right or left)
- Maniglia con rosette senza bocchette / Lever handle on rose without rose for key
- Coppie impugnature (CM) con grano e ferro senza rosette e senza bocchette / Pair levers (CM) with grub screws and square pin without rose and without rose for key

art. 171 ALISE'

design: Studio Reguitti
 materiale: Impugnatura Zama
 material: Lever Zamak

TeKnoMetal
 Linea in zama

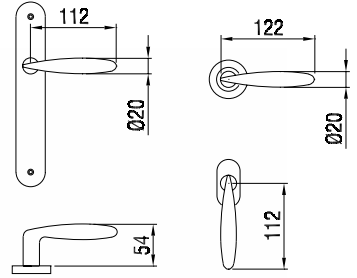

171 MR 006 ZSC



171 MR 004 ZSC



171 MR 008 SNV



171 MR 009 ZSC



171 MR 816 SNV



171 MR 007 ZCR



171 MP 188 ZSC



171 SE 070 ZSC
 171 SG 070 ZSC











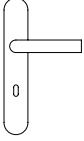

171 DK 024 ZSC

VERSIONI / VERSIONS



Finiture
Finishes

					ZSC ZCR	SNV	NR	PVD	
MANIGLIA CON PLACCA / LEVER HANDLE ON PLATE									
	171 MP 188	Maniglia con placca Lever Handle on plate	188 mm 255x42	con molla e grano with spring and grub screw	•			•	1
	171 MP 026	Maniglia con placca Lever Handle on plate	026 mm 225x26	"stretta" con grano reduced with grub screw	•				1
MANIGLIA CON ROSETTA / LEVER HANDLE ON ROSE									
	171 MR 004	Maniglia con rosetta Lever Handle on rose	004 mm Ø45x9	con molla e grano with spring and grub screw	•	•	•	•	2
	171 MR 006	Maniglia con rosetta Lever Handle on rose	006 mm Ø50x8	tipo lusso con molla e grano luxu type with spring and grub screw	•	•		•	2
	171 MR 007	Maniglia con rosetta Lever Handle on rose	007 mm 67x27	ovale stretta con grano oval and reduced with grub screw	•				2
	171 MR 008	Maniglia con rosetta Lever Handle on rose	008 mm Ø50x8	con molla e grano with spring and grub screw	•	•			2
	171 MR 009	Maniglia con rosetta Lever Handle on rose	009 mm 62x32	ovale con molla e grano oval with spring and grub screw	•			•	1
	171 MR 416	Maniglia con rosetta Lever Handle on rose	416 mm Ø45x9	con molla e grano with spring and grub screw	•	•	•	•	1
	171 MR 816	Maniglia con rosetta Lever Handle on rose	816 mm Ø50x10	con molla e grano with spring and grub screw	•	•			1
	171 MR 916	Maniglia con rosetta Lever Handle on rose	916 mm 62x32	ovale con molla e grano oval with spring and grub screw	•	•			1
CREMONESE / WINDOW HANDLE WITH MECHANISM									
	171 SG 070*	Cremonese con placca Window Handle on plate	070 mm 189x36	coprivite con gioco with cover-screw plate with mechanism	•				2
MARTELLINA / WINDOW HANDLE WITHOUT MECHANISM									
	171 SE 070*	Martellina con placca Window Handle on plate	070 mm 189x36	coprivite q. 7 with cover-screw plate with square-pin mm 7	•				2
DREH KIPP / DREH KIPP									
	171 DK 015	Dreh Kipp con rosetta Dreh Kipp on rose	015 mm 65x31	con movimento in metallo with metal mechanism	•	•	•	•	3
	171 DK 024	Dreh Kipp con rosetta Dreh Kipp on rose	024 mm 65x31	c/mov. in metallo e quadro autoregolante with metal mec. and adjustable square-pin	•			•	3

* Placca adatta a movimenti intercambiabili
Plate suitable to interchangeable movements



171 MR 009 PVD



171 MR 416 NR



171 MP 026 ZCR



171 MR 916 ZSC

Per caratteristiche tecniche rosette vedi apposito capitolo soluzioni tecniche e componenti / For technical specifications rosettes see specific section technical solutions and components

A RICHIESTA / ON REQUEST:

- Mezza maniglia con placca o con rosetta (specificare se destra o sinistra) / Half lever handle on plate or on rose (to specify if right or left)
- Maniglia con rosette senza bocchette / Lever handle on rose without rose for key
- Coppie impugnature (CM) con grano e ferro senza rosette e senza bocchette / Pair levers (CM) with grub screws and square pin without rose and without rose for key

art. **173** SASHA

design: Studio Reguitti
 materiale: Ottone
 material: Solid Brass

Brass Class
 100% Ottone

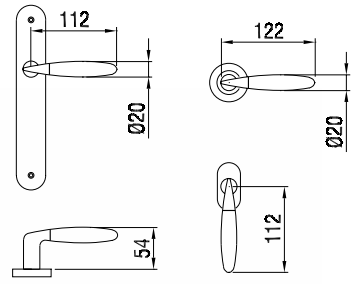

173 MR 006 OSC/OC



173 MR 006 OS/LV



173 MR 006 OSC/OC



rosetta OSC

173 MR 008 OSC/OC/OSC



173 MR 004 OS/LV



173 MR 009 OS/LV



173 MR 416 OS/LV



173 MP 188 OS/LV



173 SE 070 OS/LV
 173 SG 070 OS/LV



173 DK 015 OS/LV
 173 DK 024 OS/LV

VERSIONI / VERSIONS



Finiture
Finishes

					OS/LV	OSC/OC	OSC/OC/OSC base Sat.Crom.	
MANIGLIA CON PLACCA / LEVER HANDLE ON PLATE								
	173 MP 188	Maniglia con placca Lever Handle on plate	188 mm 255x42	con molla e grano with spring and grub screw	•	•	•	1
	173 MP 026	Maniglia con placca Lever Handle on plate	026 mm 225x26	stretta con grano reduced with grub screw	•	•	•	1
	173 MP 248	Maniglia con placca Lever Handle on plate	248 mm 248x50	con molla e grano with spring and grub screw	•	•	•	1
MANIGLIA CON ROSETTA / LEVER HANDLE ON ROSE								
	173 MR 004	Maniglia con rosetta Lever Handle on rose	004 mm Ø45x9	con molla e grano with spring and grub screw	•	•	•	2
	173 MR 006	Maniglia con rosetta Lever Handle on rose	006 mm Ø50x8	tipo lusso con molla e grano lusso type with spring and grub screw	•	•	•	1
	173MR006-61	Maniglia con rosetta Lever Handle on rose	006 mm Ø50x8	lusso con molla e grano con bocchetta 068 lusso type w/spring, grub scr., rose for key 068			•	1
	173MR006-62	Maniglia con rosetta Lever Handle on rose	006 mm Ø50x8	lusso c.molla e grano c.bocchetta 068 yale l.type w/spr., grub scr. - rose for key 068 yale			•	1
	173 MR 007	Maniglia con rosetta Lever Handle on rose	007 mm 67x27	ovale stretta con grano oval and reduced with grub screw	•	•	•	2
	173 MR 008	Maniglia con rosetta Lever Handle on rose	008 mm Ø50x8	con molla e grano with spring and grub screw	•	•	•	1
	173 MR 009	Maniglia con rosetta Lever Handle on rose	009 mm 62x32	ovale con molla e grano oval with spring and grub screw	•	•	•	1
	173 MR 416	Maniglia con rosetta Lever Handle on rose	416 mm Ø45x9	con molla e grano with spring and grub screw	•	•	•	1
	173 MR 916	Maniglia con rosetta Lever Handle on rose	916 mm 62x32	ovale con molla e grano oval with spring and grub screw	•	•	•	1
CREMONESE / WINDOW HANDLE WITH MECHANISM								
	173 SG 070*	Cremonese con placca Window Handle on plate	070 mm 189x36	coprivite con gioco with cover-screw plate with mechanism	•	•	•	2
MARTELLINA / WINDOW HANDLE WITHOUT MECHANISM								
	173 SE 070*	Martellina con placca Window Handle on plate	070 mm 189x36	coprivite q.7 with cover-screw plate with square-pin mm 7	•	•	•	2
DREH KIPP / DREH KIPP								
	173 DK 015	Dreh Kipp con rosetta Dreh Kipp on rose	015 mm 65x31	con movimento in metallo with metal mechanism	•	•	•	3
	173 DK 024	Dreh Kipp con rosetta Dreh Kipp on rose	024 mm 65x31	c/mov. in metallo e quadro autoregolante with metal mec. and adjustable square-pin	•	•	•	3

*Placca adatta a movimenti intercambiabili
Plate suitable to interchangeable movements



173 MR 006-61 OSC/OC/OSC



173 MR 006-62 OSC/OC/OSC

Per caratteristiche tecniche rosette vedi apposito capitolo soluzioni tecniche e componenti / For technical specifications rosettes see specific section technical solutions and components

A RICHIESTA / ON REQUEST:

- Mezza maniglia con placca o con rosetta (specificare se destra o sinistra) / Half lever handle on plate or on rose (to specify if right or left)
- Maniglia con rosette senza bocchette / Lever handle on rose without rose for key
- Coppie impugnature (CM) con grano e ferro senza rosette e senza bocchette / Pair levers (CM) with grub screws and square pin without rose and without rose for key

art. 173 SASHA

design: Studio Reguitti
 materiale: Impugnatura Zama
 material: Lever Zamak

TeKnoMetal
 Linea in zama

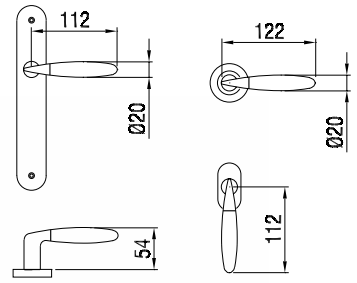

173 MR 006 ZSC/ZCR



173 MR 008 ZSC/ZCR/OSC



173 MR 004 ZSC/ZCR



173 MR 416 ZSC/ZCR



173 MR 816 ZSC/ZCR/OSC



173 MR 009 ZSC/ZCR



173 MP 188 ZSC/ZCR



173 SE 070 ZSC/ZCR
 173 SG 070 ZSC/ZCR



173 DK 024 ZSC/ZCR

VERSIONI / VERSIONS



Finishes
Finiture

ZSC/ZCR

ZSC/ZCR/OSC
base sat.crom.



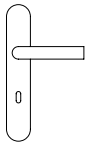

MANIGLIA CON PLACCA / LEVER HANDLE ON PLATE



173 MP 188	Maniglia con placca Lever Handle on plate	188	mm 255x42	con molla e grano with spring and grub screw	•	•	1
173 MP 026	Maniglia con placca Lever Handle on plate	026	mm 225x26	"stretta" con grano reduced with grub screw	•	•	1

MANIGLIA CON ROSETTA / LEVER HANDLE ON ROSE



173 MR 004	Maniglia con rosetta Lever Handle on rose	004	mm Ø45x9	con molla e grano with spring and grub screw	•	•	2
173 MR 006	Maniglia con rosetta Lever Handle on rose	006	mm Ø50x8	tipo lusso con molla e grano luxu type with spring and grub screw	•	•	2
173 MR 007	Maniglia con rosetta Lever Handle on rose	007	mm 67x27	ovale stretta con grano oval and reduced with grub screw	•	•	2
173 MR 008	Maniglia con rosetta Lever Handle on rose	008	mm Ø50x8	con molla e grano with spring and grub screw	•	•	2
173 MR 009	Maniglia con rosetta Lever Handle on rose	009	mm 62x32	ovale con molla e grano oval with spring and grub screw	•	•	1
 173 MR 416	Maniglia con rosetta Lever Handle on rose	416	mm Ø45x9	con molla e grano with spring and grub screw	•	•	1
 173 MR 816	Maniglia con rosetta Lever Handle on rose	816	mm Ø50x10	con molla e grano with spring and grub screw	•	•	1

CREMONESE / WINDOW HANDLE WITH MECHANISM



173 SG 070*	Cremonese con placca Window Handle on plate	070	mm 189x36	coprivite con gioco with cover-screw plate with mechanism	•	•	2
-------------	--	-----	-----------	--	---	---	---

MARTELLINA / WINDOW HANDLE WITHOUT MECHANISM



173 SE 070*	Martellina con placca Window Handle on plate	070	mm 189x36	coprivite q. 7 with cover-screw plate with square-pin mm 7	•	•	2
-------------	---	-----	-----------	---	---	---	---

DREH KIPP / DREH KIPP



173 DK 015	Dreh Kipp con rosetta Dreh Kipp on rose	015	mm 65x31	con movimento in metallo with metal mechanism	•	•	3
173 DK 024	Dreh Kipp con rosetta Dreh Kipp on rose	024	mm 65x31	c/mov. in metallo e quadro autoregolante with metal mec. and adjustable square-pin	•	•	3
173 DK 075	Dreh Kipp con rosetta Safety DK on rose	075	mm 64x30	con mov. securblock e pulsante di sicurezza with securblock system and push button	•	•	2
173 DK C67	Dreh Kipp con rosetta Safety DK on rose	C67	mm 69x33	con chiave e cilindro e movimento in metallo with key and cylinder and metal mechanism	•	•	1

*Placca adatta a movimenti intercambiabili
Plate suitable to interchangeable movements



173 DK C67 ZSC/ZCR/OSC

Per caratteristiche tecniche rosette vedi apposito capitolo soluzioni tecniche e componenti / For technical specifications rosettes see specific section technical solutions and components

A RICHIESTA / ON REQUEST:

- Mezza maniglia con placca o con rosetta (specificare se destra o sinistra) / Half lever handle on plate or on rose (to specify if right or left)
- Maniglia con rosette senza bocchette / Lever handle on rose without rose for key
- Coppie impugnature (CM) con grano e ferro senza rosette e senza bocchette / Pair levers (CM) with grub screws and square pin without rose and without rose for key

art. 175 PUBLIC

design: Marco Pialorsi
materiale: Ottone
material: Solid Brass

Brass Class
100% Ottone



175 MR 816 OSC 



175 MR 416 OSC 



175 MR 005 OSC



175 MR 009 OC



175 MP 188 LV



175 SE 070 LV
175 SG 070 LV





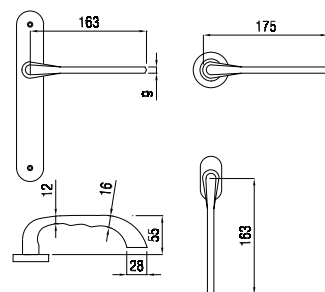





175 DK 015 LV

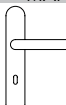

VERSIONI / VERSIONS



Finiture
Finishes

						LV	BG	OC	OSC	
MANIGLIA CON PLACCA / LEVER HANDLE ON PLATE										
	175 MP 188	Maniglia con placca Lever Handle on plate	188 mm 255x42	con molla e grano with spring and grub screw		•		•		1
	175 MP 130	Maniglia con placca Lever Handle on plate	130 mm 245x50	con molla e grano with spring and grub screw		•		•		1
MANIGLIA CON ROSETTA / LEVER HANDLE ON ROSE										
	175 MR 005	Maniglia con rosetta Lever Handle on rose	005 mm Ø50x8	tipo lusso con molla e grano luxury type with spring and grub screw		•		•		1
	175 MR 009	Maniglia con rosetta Lever Handle on rose	009 mm 62x32	ovale con molla e grano oval with spring and grub screw		•		•		1
	175 MR 416	Maniglia con rosetta Lever Handle on rose	416 mm Ø45x9	con molla e grano with spring and grub screw		•		•		1
	175 MR 816	Maniglia con rosetta Lever Handle on rose	816 mm Ø50x10	con molla e grano with spring and grub screw		•		•		1
CREMONESE / WINDOW HANDLE WITH MECHANISM										
	175 SG 070*	Cremonese con placca Window Handle on plate	070 mm 189x36	coprivite con gioco with cover-screw plate with mechanism		•		•		2
MARTELLINA / WINDOW HANDLE WITHOUT MECHANISM										
	175 SE 070*	Martellina con placca Window Handle on plate	070 mm 189x36	coprivite q.7 with cover-screw plate with square-pin mm 7		•		•		2
DREH KIPP / DREH KIPP										
	175 DK 015	Dreh Kipp con rosetta Dreh Kipp on rose	015 mm 65x31	con movimento in metallo with metal mechanism		25,02		27,27		3

* Placca adatta a movimenti intercambiabili / Plate suitable to interchangeable movements

A RICHIESTA / ON REQUEST:

- Mezza maniglia con placca o con rosetta (specificare se destra o sinistra) / Half lever handle on plate or on rose (to specify if right or left)
- Maniglia con rosette senza bocchette / Lever handle on rose without rose for key
- Coppie impugnature (CM) con grano e ferro senza rosette e senza bocchette / Pair levers (CM) with grub screws and square pin without rose and without rose for key

art. 178 CAMILLA

materiale: Ottone
material: Solid Brass

Brass Class
100% Ottone



178 MR 006 OSC/OC

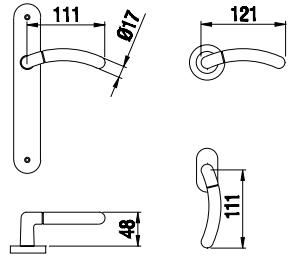

178 MR 009 OS/LV



178 MR 816 OSC/OC



178 MP 066 OSC/OC

destro/right



178 DK 015 OSC/OC



178 MR 004 OS/LV



178 MR 416 OSC/OC

VERSIONI / VERSIONS



MANIGLIA CON PLACCA / LEVER HANDLE ON PLATE					OS/LV	OSC/OC	
	178 MP 066	Maniglia con placca Lever Handle on plate	066 mm 240x37	con molla e grano with spring and grub screw	•	•	1
MANIGLIA CON ROSETTA / LEVER HANDLE ON ROSE							
	178 MR 004	Maniglia con rosetta Lever Handle on rose	004 mm Ø45x9	con molla e grano with spring and grub screw	•	•	2
	178 MR 006	Maniglia con rosetta Lever Handle on rose	006 mm Ø50x8	tipo lusso con molla e grano luxu type with spring and grub screw	•	•	2
	178 MR 009	Maniglia con rosetta Lever Handle on rose	009 mm 62x32	ovale con molla e grano oval with spring and grub screw	•	•	1
	178 MR 416	Maniglia con rosetta Lever Handle on rose	416 mm Ø45x9	con molla e grano with spring and grub screw	•	•	1
	178 MR 816	Maniglia con rosetta Lever Handle on rose	816 mm Ø50x10	con molla e grano with spring and grub screw	•	•	1
CREMONESE / WINDOW HANDLE WITH MECHANISM							
	178 SG 070*	Cremonese con placca Window Handle on plate	070 mm 189x36	coprivite con gioco with cover-screw plate with mechanism	•	•	2
MARTELLINA / WINDOW HANDLE WITHOUT MECHANISM							
	178 SE 070*	Martellina con placca Window Handle on plate	070 mm 189x36	coprivite q.7 with cover-screw plate with square-pin mm 7	19,77	22,02	2
DREH KIPP / DREH KIPP							
	178 DK 015	Dreh Kipp destro con rosetta Dreh Kipp (right) on rose	015 mm 65x31	con movimento in metallo with metal mechanism	•	•	3

* Placca adatta a movimenti intercambiabili / Plate suitable to interchangeable movements

A RICHIESTA / ON REQUEST:

- Mezza maniglia con placca o con rosetta (specificare se destra o sinistra) / Half lever handle on plate or on rose (to specify if right or left)
- Maniglia con rosette senza bocchette / Lever handle on rose without rose for key
- Coppie impugnature (CM) con grano e ferro senza rosette e senza bocchette / Pair levers (CM) with grub screws and square pin without rose and without rose for key

art. 179 CASSIA



179 MR 006 ZSC

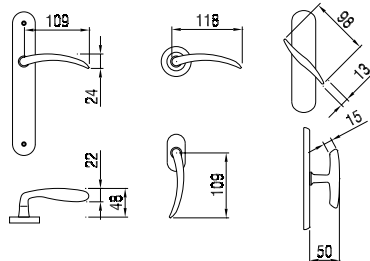

179 MP 159 LV



179 MR 004 LV



179 MA 137 LV
179 CR 137 LV



destro/right

179 DK 015 LV

VERSIONI / VERSIONS



Finiture
Finishes

MANIGLIA CON PLACCA / LEVER HANDLE ON PLATE

179 MP 159 Maniglia con placca 159 mm 231x35 con molla
Lever Handle on plate with spring

179 MP 159 Maniglia con placca 159 mm 231x35 con molla e grano
Lever Handle on plate with spring and grub screw

MANIGLIA CON ROSETTA / LEVER HANDLE ON ROSE

179 MR 004 Maniglia con rosetta 004 mm Ø45x9 con molla e grano
Lever Handle on rose with spring and grub screw

179 MR 006 Maniglia con rosetta 006 mm Ø50x8 tipo lusso con molla e grano
Lever Handle on rose lusso type with spring and grub screw

CREMONESE / WINDOW HANDLE WITH MECHANISM

179 CR 137* Cremonese con placca 137 mm 167x40 con fori viti con gioco
Window Handle on plate with holes for screws with mechanism

MARTELLINA / WINDOW HANDLE WITHOUT MECHANISM

179 MA 137* Martellina con placca 137 mm 167x40 con fori viti q.7
Window Handle on plate with holes for screws with square-pin mm 7

DREH KIPP / DREH KIPP

179 DK 015 Dreh Kipp destro con rosetta 015 mm 65x31 con movimento in metallo
Dreh Kipp (right) on rose with metal mechanism

* Placca adatta a movimenti intercambiabili
Plate suitable to interchangeable movements

LV

ZSC
ZCR



A RICHIESTA / ON REQUEST:

- Mezza maniglia con placca o con rosetta (specificare se destra o sinistra) / Half lever handle on plate or on rose (to specify if right or left)
- Maniglia con rosette senza bocchette / Lever handle on rose without rose for key
- Coppie impugnature (CM) con grano e ferro senza rosette e senza bocchette / Pair levers (CM) with grub screws and square pin without rose and without rose for key

art. 182 APPIA

materiale: Ottone
material: Solid Brass

Brass Class
100% Ottone



182 MR 006 OC

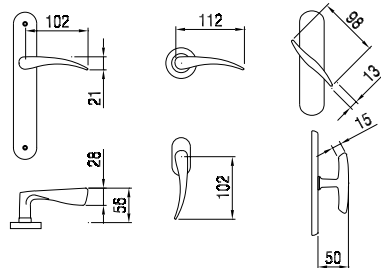

182 MP 159 LV



182 MR 004 LV



182 MA 137 LV
182 CR 137 LV



182 DK 015 LV

destra/right

VERSIONI / VERSIONS



Finire
Finishes

LV

OSC
OC



MANIGLIA CON PLACCA / LEVER HANDLE ON PLATE

182 MP 159 Maniglia con placca 159 mm 231x35 con molla
Lever Handle on plate with spring

•

•

1

182 MP 159 Maniglia con placca 159 mm 231x35 con molla e grano
Lever Handle on plate with spring and grub screw

•

•

1

MANIGLIA CON ROSETTA / LEVER HANDLE ON ROSE

182 MR 004 Maniglia con rosetta 004 mm Ø45x9 con molla e grano
Lever Handle on rose with spring and grub screw

•

•

5

182 MR 006 Maniglia con rosetta 006 mm Ø50x8 tipo lusso con molla e grano
Lever Handle on rose lusso type with spring and grub screw

•

•

2

CREMONESE / WINDOW HANDLE WITH MECHANISM

182 CR 137* Cremonese con placca 137 mm 167x40 con fori viti con gioco
Window Handle on plate with holes for screws with mechanism

•

•

6

MARTELLINA / WINDOW HANDLE WITHOUT MECHANISM

182 MA 137* Martellina con placca 137 mm 167x40 con fori viti q.7
Window Handle on plate with holes for screws with square-pin mm 7

•

•

6

DREH KIPP / DREH KIPP

182 DK 015 Dreh Kipp destro con rosetta 015 mm 65x31 con movimento in metallo
Dreh Kipp (right) on rose with metal mechanism

•

•

6

* Placca adatta a movimenti intercambiabili
Plate suitable to interchangeable movements

A RICHIESTA / ON REQUEST:

- Mezza maniglia con placca o con rosetta (specificare se destra o sinistra) / Half lever handle on plate or on rose (to specify if right or left)
- Maniglia con rosette senza bocchette / Lever handle on rose without rose for key
- Coppie impugnature (CM) con grano e ferro senza rosette e senza bocchette / Pair levers (CM) with grub screws and square pin without rose and without rose for key

art. 183 BETTY

materiale: Ottone
material: Solid Brass

Brass Class
100% Ottone

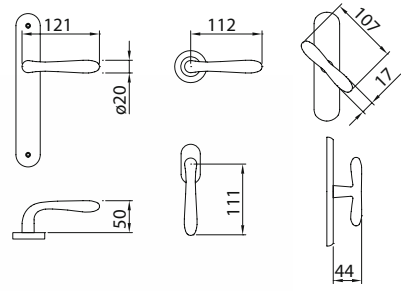

183 MR 006 LV



183 MR 416 LV



183 MR 006 BG



183 MR 004 OSC



183 MR 004 OC



183 MR 007 LV



183 MR 916 OSC



183 CR 189 LV
183 MA 189 LV



183 DK C67 LV



183 MP 066 LV



183 MA 137 LV
183 CR 137 LV



183 DK 024 LV

MANIGLIA CON PLACCA / LEVER HANDLE ON PLATE

	183 MP 066	Maniglia con placca Lever Handle on plate	066	mm 240x37	con molla with spring	•	•	1
	183 MP 066	Maniglia con placca Lever Handle on plate	066	mm 240x37	con molla e grano with spring and grub screw	•	•	1
	183 MP 026	Maniglia con placca Lever Handle on plate	026	mm 225x26	"stretta" con grano "reduced" with grub screw	•	•	1
	183 MP 188	Maniglia con placca Lever Handle on plate	188	mm 255x42	con molla e grano with spring and grub screw	•	•	1
	183 PW 066	Maniglia con placca Lever Handle on plate	066	mm 240x37	con WC 503 con molla with WC turn 503 with spring	•	•	1
	183 PW 066	Maniglia con placca Lever Handle on plate	066	mm 240x37	con WC 503 con molla e grano with WC turn 503 with spring and grub screw	•	•	1
	183 PG 066	Maniglia con placca Lever Handle on plate	066	mm 240x37	con WC 512 grande con molla with WC turn 512 with spring	•	•	1
	183 PG 066	Maniglia con placca Lever Handle on plate	066	mm 240x37	con WC 512 grande con molla e grano with WC turn 512 with spring and grub screw	•	•	1

MANIGLIA CON ROSETTA / LEVER HANDLE ON ROSE

	183 MR 004	Maniglia con rosetta Lever Handle on rose	004	mm Ø45x9	con molla e grano with spring and grub screw	•	•	2
	183 MR 006	Maniglia con rosetta Lever Handle on rose	006	mm Ø50x8	tipo lusso con molla e grano lusso type with spring and grub screw	•	•	2
	183 MR 007	Maniglia con rosetta Lever Handle on rose	007	mm 67x27	ovale stretta con grano oval and reduced with grub screw	•	•	2
	183 MR 009	Maniglia con rosetta Lever Handle on rose	009	mm 62x32	ovale con molla e grano oval with spring and grub screw	•	•	1
	183 MR 416	Maniglia con rosetta Lever Handle on rose	416	mm Ø45x9	con molla e grano with spring and grub screw	•	•	5
	183 MR 916	Maniglia con rosetta Lever Handle on rose	916	mm 62x32	ovale con molla e grano oval with spring and grub screw	•	•	1
	183 RW 004	Maniglia con rosetta Lever Handle on rose	004	mm Ø45x9	con WC 503 with WC turn 503	•	•	1
	183 RW 006	Maniglia con rosetta Lever Handle on rose	006	mm Ø50x8	tipo lusso con WC 503 lusso type with WC turn 503	•	•	1
	183 RG 004	Maniglia con rosetta Lever Handle on rose	004	mm Ø45x12	con WC 512 grande with WC turn 512	•	•	1
	183 RG 006	Maniglia con rosetta Lever Handle on rose	006	mm Ø50x8	tipo lusso con WC 512 grande lusso type with WC turn 512	•	•	1

CREMONESE / WINDOW HANDLE WITH MECHANISM

	183 CR 137	Cremonese con placca Window Handle on plate	137	mm 167x40	con fori viti con gioco with holes for screws with mechanism	•	•	2
	183 CR 189	Cremonese con placca Window Handle on plate	189	mm 189x38	con fori viti con gioco with holes for screws with mechanism	•	•	2

MARTELLINA / WINDOW HANDLE WITHOUT MECHANISM

	183 MA 137	Martellina con placca Window Handle on plate	137	mm 167x40	con fori viti q. 7 mm with holes for screws with square-pin mm 7	•	•	2
	183 MA 189	Martellina con placca Window Handle on plate	189	mm 189x38	con fori viti q. 7 mm with holes for screws with square-pin mm 7	•	•	2

DREH KIPP / DREH KIPP

	183 DK 015	Dreh Kipp con rosetta Dreh Kipp on rose	015	mm 65x31	con movimento in metallo with metal mechanism	•	•	6
	183 DK 024	Dreh Kipp con rosetta Dreh Kipp on rose	024	mm 65x31	con movimento in metallo, preassemblato senza grano with fixed metal mechanism without grub screw	•	•	6
	183 DK 074	Dreh Kipp con rosetta Safety DK on rose	074	mm 64x30	con mov. securblock e quadro autoregolante with securblock and adjustable square-pin	•	•	2
	183 DK C67	Dreh Kipp con rosetta Dreh Kipp on rose	C67	mm 69x33	con chiave e cilindro e movimento in metallo with key and cylinder and metal mechanism	•	•	1

A RICHIESTA / ON REQUEST:

- Mezza maniglia con placca o con rosetta (specificare se destra o sinistra) / Half lever handle on plate or on rose (to specify if right or left)
- Maniglia con rosette senza bocchette / Lever handle on rose without rose for key
- Coppie impugnature (CM) con grano e ferro senza rosette e senza bocchette / Pair levers (CM) with grub screws and square pin without rose and without rose for key
- Cremonesi e martelline con impugnatura a maniglia (segretini)
- Cremonese e martellina con placca coprivite e movimento intercambiabile

art. 183 BETTY

design: Studio Reguitti
 materiale: Impugnatura Zama
 material: Lever Zamak

TeKnoMetal
 Linea in zama

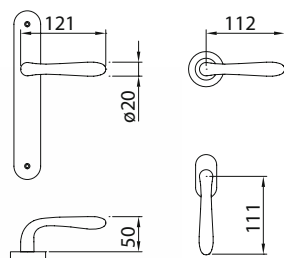

183 MR 006 ZCR



183 MR 007 ZCR



183 MR 004 ZSC



183 MR 416 ZSC



183 MR 816 SNV



183 MR 009 ZSC



183 MP 026 ZSC



183 DK 024 ZCR



183 DK 024 PVD



183 DK C67 ZSC

VERSIONI / VERSIONS



Finiture
Finishes

ZSC
ZCR

SNV

NR

PVD



MANIGLIA CON PLACCA / LEVER HANDLE ON PLATE

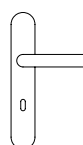

183 MP 066	Maniglia con placca Lever Handle on plate	066	mm 240x37	con molla e grano with spring and grub screw	•				2
183 MP 026	Maniglia con placca Lever Handle on plate	026	mm 225x26	"stretta" con grano reduced with grub screw	•				1

MANIGLIA CON ROSETTA / LEVER HANDLE ON ROSE

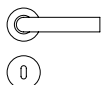

183 MR 004	Maniglia con rosetta Lever Handle on rose	004	mm Ø45x9	con molla e grano with spring and grub screw	•	•	•	•	5
183 MR 006	Maniglia con rosetta Lever Handle on rose	006	mm Ø50x8	tipo lusso con molla e grano luxu type with spring and grub screw	•	•		•	2
183 MR 007	Maniglia con rosetta Lever Handle on rose	007	mm 67x27	ovale stretta con grano oval and reduced with grub screw	•				2
183 MR 008	Maniglia con rosetta Lever Handle on rose	008	mm Ø50x8	con molla e grano with spring and grub screw	•	•			2
183 MR 009	Maniglia con rosetta Lever Handle on rose	009	mm 62x32	ovale con molla e grano oval with spring and grub screw	•			•	1
183 MR 416	Maniglia con rosetta Lever Handle on rose	416	mm Ø45x9	con molla e grano with spring and grub screw	•	•	•	•	5
183 MR 816	Maniglia con rosetta Lever Handle on rose	816	mm Ø50x10	con molla e grano with spring and grub screw	•	•			1

DREH KIPP / DREH KIPP



183 DK 015	Dreh Kipp con rosetta Dreh Kipp on rose	015	mm 65x31	con movimento in metallo with metal mechanism	•	•	•	•	6
183 DK 024	Dreh Kipp con rosetta Dreh Kipp on rose	024	mm 65x31	c/mov. in metallo e quadro autoregolante with metal mec. and adjustable square-pin	•			•	6
183 DK 074	Dreh Kipp con rosetta Safety DK on rose	074	mm 64x30	con mov. securblock e quadro autoregolante with securblock and adjustable square-pin	•			•	2
183 DK C15	Dreh Kipp con rosetta Dreh Kipp on rose	C15	mm 102x31	con movimento con chiave with mechanism with key	•				2
183 DK C67	Dreh Kipp con rosetta Safety DK on rose	C67	mm 69x33	c/chave e cilindro e mov. in metallo with key and cylinder and metal mec.	•			•	1

* Placca adatta a movimenti intercambiabili
Plate suitable to interchangeable movements



183 DK C15 ZCR



183 MR 816 ZSC



183 MR 416 PVD

Per caratteristiche tecniche rosette vedi apposito capitolo soluzioni tecniche e componenti / For technical specifications rosettes see specific section technical solutions and components

A RICHIESTA / ON REQUEST:

- Mezza maniglia con placca o con rosetta (specificare se destra o sinistra) / Half lever handle on plate or on rose (to specify if right or left)
- Maniglia con rosette senza bocchette / Lever handle on rose without rose for key
- Coppie impugnature (CM) con grano e ferro senza rosette e senza bocchette / Pair levers (CM) with grub screws and square pin without rose and without rose for key

art. 184 ASTRA

design: Studio Reguitti
 materiale: Ottone
 material: Solid Brass

Brass Class
 100% Ottone

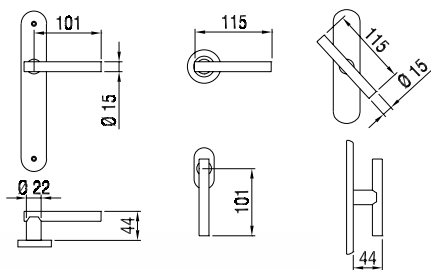

184 MR 009 OS/LV



184 MR 416 OC



184 MR 005 OC



184 MR 005 OSC/OC



184 MR 005 OS/LV



184 MR 005 OC/LV

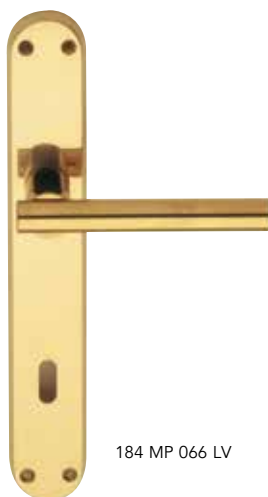

184 MP 066 LV



184 MA 070 LV
 184 CR 070 LV



184 DK 015 LV



Finiture
Finishes

					LV OS/LV	OSC OC	OC/LV OSC/OC	
MANIGLIA CON PLACCA / LEVER HANDLE ON PLATE								
	184 MP 066	Maniglia con placca Lever Handle on plate	066 mm 240x37	con molla e grano with spring and grub screw	•	•	•	1
	184 MP 130	Maniglia con placca Lever Handle on plate	130 mm 245x50	con molla e grano with spring and grub screw	•	•	•	1
MANIGLIA CON ROSETTA / LEVER HANDLE ON ROSE								
	184 MR 005	Maniglia con rosetta Lever Handle on rose	005 mm Ø50x8	tipo lusso con molla e grano luxu type with spring and grub screw	•	•	•	2
	184 MR 009	Maniglia con rosetta Lever Handle on rose	009 mm 62x32	ovale con molla e grano oval with spring and grub screw	•	•	•	1
	184 MR 416	Maniglia con rosetta Lever Handle on rose	416 mm Ø45x9	con molla e grano with spring and grub screw	•	•	•	1
	184 MR Q86	Maniglia con rosetta Lever Handle on rose	Q86 mm 50x50	con molla e grano with spring and grub screw	•	•	•	1
CREMONESE / WINDOW HANDLE WITH MECHANISM								
	184 CR 137	Cremonese con placca Window Handle on plate	137 mm 167x40	con fori viti con gioco with holes for screws with mechanism	•	•	•	2
	184 CR 070*	Cremonese con placca Window Handle on plate	070 mm 189x36	coprivite con gioco with cover-screw plate with mechanism	•	•	•	2
MARTELLINA / WINDOW HANDLE WITHOUT MECHANISM								
	184 MA 137	Martellina con placca Window Handle on plate	137 mm 167x40	con fori viti q.7 with holes for screws with square-pin mm 7	•	•	•	2
	184 MA 070*	Martellina con placca Window Handle on plate	070 mm 189x36	coprivite q.7 with cover-screw plate with square-pin mm 7	•	•	•	2
DREH KIPP / DREH KIPP								
	184 DK 015	Dreh Kipp con rosetta Dreh Kipp on rose	015 mm 65x31	con movimento in metallo with metal mechanism	•	•	•	3

* Placca adatta a movimenti intercambiabili
Plate suitable to interchangeable movements



184 MR Q86 OC



184 MD 005 LV

Vedi capitolo "Porte d'entrata"
See chapter "Entrance doors"



184 MP 066 OSC



184 MP 130 OSC

Per caratteristiche tecniche rosette vedi apposito capitolo soluzioni tecniche e componenti / For technical specifications rosettes see specific section technical solutions and components

A RICHIESTA / ON REQUEST:

- Mezza maniglia con placca o con rosetta (specificare se destra o sinistra) / Half lever handle on plate or on rose (to specify if right or left)
- Maniglia con rosette senza bocchette / Lever handle on rose without rose for key
- Coppie impugnature (CM) con grano e ferro senza rosette e senza bocchette / Pair levers (CM) with grub screws and square pin without rose and without rose for key
- Cremonesi e martelline con impugnatura a maniglia (segretini)

art. 185 ALMA

design: Marco Pialorsi
 materiale: Ottone
 material: Solid Brass

Brass Class
 100% Ottone

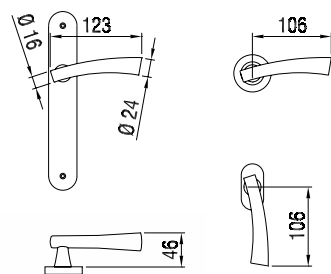

185 MR 006 LV



185 MR 816 OSC



185 MR 416 OC



185 MR 006 OSC



185 MR 006 OS/LV



185 MR 006 OC/LV



185 MP 248 OSC



185 MP 188 LV

destra/right







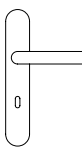
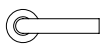

185 SE 070 LV
 185 SG 070 LV

VERSIONI / VERSIONS

+6%

Finiture
Finishes

					LV OS/LV	OSC OC	OSC/OC OC/LV	
MANIGLIA CON PLACCA / LEVER HANDLE ON PLATE								
	185 MP 188	Maniglia con placca Lever Handle on plate	188 mm 255x42	con molla e grano with spring and grub screw	•	•	•	1
	185 MP 130	Maniglia con placca Lever Handle on plate	130 mm 245x50	con molla e grano with spring and grub screw	•	•	•	1
	185 MP 248	Maniglia con placca Lever Handle on plate	248 mm 248x50	con molla e grano with spring and grub screw	•	•	•	1
MANIGLIA CON ROSETTA / LEVER HANDLE ON ROSE								
	185 MR 006	Maniglia con rosetta Lever Handle on rose	006 mm Ø50x8	tipo lusso con molla e grano lusso type with spring and grub screw	•	•	•	1
	185 MR 416	Maniglia con rosetta Lever Handle on rose	416 mm Ø45x9	con molla e grano with spring and grub screw	•	•	•	1
	185 MR 816	Maniglia con rosetta Lever Handle on rose	816 mm Ø50x10	con molla e grano with spring and grub screw	•	•	•	1
CREMONESE / WINDOW HANDLE WITH MECHANISM								
	185 SG 137	Cremonese con placca Window Handle on plate	137 mm 167x40	con fori viti con gioco with holes for screws with mechanism	•	•	•	2
	185 SG 070*	Cremonese con placca Window Handle on plate	070 mm 189x36	coprivite con gioco with cover-screw plate with mechanism	•	•	•	2
MARTELLINA / WINDOW HANDLE WITHOUT MECHANISM								
	185 SE 137	Martellina con placca Window Handle on plate	137 mm 167x40	con fori viti q.7 with holes for screws with square-pin mm 7	•	•	•	2
	185 SE 070*	Martellina con placca Window Handle on plate	070 mm 189x36	coprivite q.7 with cover-screw plate with square-pin mm 7	•	•	•	2
DREH KIPP / DREH KIPP								
	185 DK 015	Dreh Kipp destro con rosetta Dreh Kipp (right) on rose	015 mm 65x31	con movimento in metallo with metal mechanism	•	•	•	3

* Placca adatta a movimenti intercambiabili
Plate suitable to interchangeable movements

destro/right



185 DK 015 LV



185 MP 130 OSC



185 MS 002 PVD

Vedi capitolo "Porte d'entrata"
See chapter "Entrance doors"

Per caratteristiche tecniche rosette vedi apposito capitolo soluzioni tecniche e componenti / For technical specifications rosettes see specific section technical solutions and components

A RICHIESTA / ON REQUEST:

- Mezza maniglia con placca o con rosetta (specificare se destra o sinistra) / Half lever handle on plate or on rose (to specify if right or left)
- Maniglia con rosette senza bocchette / Lever handle on rose without rose for key
- Coppie impugnature (CM) con grano e ferro senza rosette e senza bocchette / Pair levers (CM) with grub screws and square pin without rose and without rose for key

art. 188 AUXILIUM

design: Marco Pialorsi
 materiale: Ottone
 material: Solid Brass

Brass Class
 100% Ottone

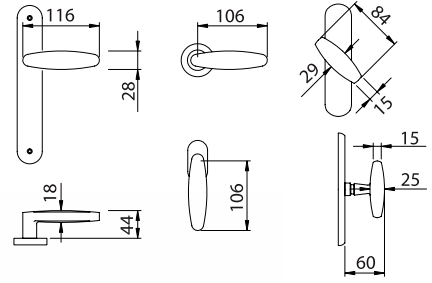

188 MR 382 OC/LV



188 MR 416 OC



188 MR 816 OSC



188 MR 382 LV



188 MR 006 OS



188 MR 382 BG



188 MR 382 OC/OSC



188 MR 009 LV



188 MP 188 LV



188 DK C15 LV



188 DK 015 LV



						OS LV BG	OSC OC	OSC/OC OC/LV OC/OSC	PVD	
MANIGLIA CON PLACCA / LEVER HANDLE ON PLATE										
	188 MP 188	Maniglia con placca Lever Handle on plate	188	mm 255x42	con molla e grano with spring and grub screw	•	•		•	1
	188 MP 248	Maniglia con placca Lever Handle on plate	248	mm 248x50	con molla e grano with spring and grub screw	•	•		•	1
MANIGLIA CON ROSETTA / LEVER HANDLE ON ROSE										
	188 MR 006	Maniglia con rosetta Lever Handle on rose	006	mm Ø50x8	tipo lusso con molla e grano luxu type with spring and grub screw	•	•	•	•	1
	188 MR 009	Maniglia con rosetta Lever Handle on rose	009	mm 62x32	ovale con molla e grano oval with spring and grub screw	•	•		•	1
	188 MR 382	Maniglia con rosetta Lever Handle on rose	382	mm Ø50x8	profilo a campana con molla e grano original profile with spring and grub screw	•	•	•		1
	188 MR 416	Maniglia con rosetta Lever Handle on rose	416	mm Ø45x9	con molla e grano with spring and grub screw	•	•			1
	188 MR 816	Maniglia con rosetta Lever Handle on rose	816	mm Ø50x10	con molla e grano with spring and grub screw	•	•			1
CREMONESE / WINDOW HANDLE WITH MECHANISM										
	188 SE 070*	Cremonese con placca Window Handle on plate	070	mm 189x36	coprivite con gioco with cover-screw plate with mechanism	•	•			2
										2
MARTELLINA / WINDOW HANDLE WITHOUT MECHANISM										
	188 SG 070*	Martellina con placca Window Handle on plate	070	mm 167x40	con fori viti q. 7 with holes for screws with square-pin mm 7	•	•			2
DREH KIPP / DREH KIPP										
	188 DK 015	Dreh Kipp con rosetta Dreh Kipp on rose	015	mm 65x31	con movimento in metallo with metal mechanism	•	•		•	3
	188 DK C15	Dreh Kipp con rosetta Dreh Kipp on rose	C15	mm 102x31	con movimento con chiave with mechanism with key	•	•			2

* Placca adatta a movimenti intercambiabili
Plate suitable to interchangeable movements



188 MP 248 OSC

Per caratteristiche tecniche rosette vedi apposito capitolo soluzioni tecniche e componenti / For technical specifications rosettes see specific section technical solutions and components

A RICHIESTA / ON REQUEST:

- Mezza maniglia con placca o con rosetta (specificare se destra o sinistra) / Half lever handle on plate or on rose (to specify if right or left)
- Maniglia con rosette senza bocchette / Lever handle on rose without rose for key
- Coppie impugnature (CM) con grano e ferro senza rosette e senza bocchette / Pair levers (CM) with grub screws and square pin without rose and without rose for key
- Cremonesi e martelline con impugnatura a maniglia (segretini)

art. 189 ROMEA

materiale: Ottone
material: Solid Brass

Brass Class
100% Ottone

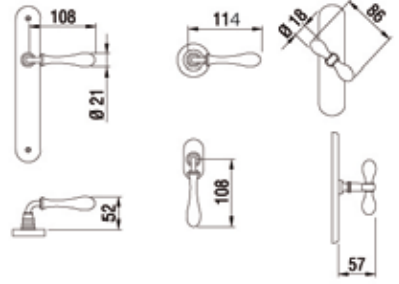

189 MR 006 LV



189 MR 006 RX



189 MR 006 AGV



189 MR 006 BG



189 MR 006 OSC



189 MR 202 AN



189 MR 006 VBN



189 MP 166 LV



189 MA 040 LV
189 CR 040 LV



189 MA 007 LV



189 DK 015 LV



						LV	BG	OSC OC	AN	AGV	
MANIGLIA CON PLACCA / LEVER HANDLE ON PLATE											
	189 MP 040	Maniglia con placca Lever Handle on plate	040	mm 244x40	con molla e grano with spring and grub screw	•			•	•	3
	189 MP 039	Maniglia con placca Lever Handle on plate	039	mm 255x50	con molla e grano with spring and grub screw	•			•	•	1
	189 MP 166	Maniglia con placca Lever Handle on plate	166	mm 242x33	con molla e grano with spring and grub screw	•			•	•	1
	189 MP 188	Maniglia con placca Lever Handle on plate	188	mm 255x42	con molla e grano with spring and grub screw	•	•				1
	189 MP 026	Maniglia con placca Lever Handle on plate	026	mm 225x26	stretta con grano reduced with grub screw	•	•		•	•	1
MANIGLIA CON ROSETTA / LEVER HANDLE ON ROSE											
	189 MR 003	Maniglia con rosetta Lever Handle on rose	003	mm Ø45x7	con molla e grano with spring and grub screw					•	2
	189 MR 004	Maniglia con rosetta Lever Handle on rose	004	mm Ø45x9	con molla e grano with spring and grub screw	•	•		•		2
	189 MR 006	Maniglia con rosetta Lever Handle on rose	006	mm Ø50x8	tipo lusso con molla e grano lusso type with spring and grub screw	•	•		•	•	2
	189 MR 202	Maniglia con rosetta Lever Handle on rose	202	mm Ø52x9	con bordo con grano with edge with grub screw	•			•	•	2
	189 MR 416	Maniglia con rosetta Lever Handle on rose	416	mm Ø45x9	con molla e grano with spring and grub screw	•	•				1
	189 MR R40	Maniglia con rosetta Lever Handle on rose	R40	mm Ø45x7	con fori viti a vista con grano with holes for screws with grub screw	•			•	•	2
CREMONESE / WINDOW HANDLE WITH MECHANISM											
	189 CR 040*	Cremonese con placca Window Handle on plate	040	mm 174x37	con gioco with mechanism	•			•	•	2
	189 CR 070*	Cremonese con placca Window Handle on plate	070	mm 189x36	coprivite con gioco with cover-screw plate with mechanism	•	•				2
MARTELLINA / WINDOW HANDLE WITHOUT MECHANISM											
	189 MA 040*	Martellina con placca Window Handle on plate	040	mm 174x37	q. 7 without mechanism with square-pin mm 7	•			•	•	2
	189 MA 070*	Martellina con placca Window Handle on plate	070	mm 189x36	coprivite q. 7 with cover-screw plate with square-pin mm 7	•	•				2
	189 MA 007	Martellina con rosetta Window Handle on rose	007	mm 67x27	q. 7 without mechanism with square-pin mm 7	•	•		•	•	6
DREH KIPP / DREH KIPP											
	189 DK 015	Dreh Kipp con rosetta Dreh Kipp on rose	015	mm 65x31	con movimento in metallo with metal mechanism	•	•		•	•	3

* Placca adatta a movimenti intercambiabili - Plate suitable to interchangeable movements



189 MP 040 BG



189 MP 039 LV



189 MP 188 OSC

A RICHIESTA / ON REQUEST:

- Mezza maniglia con placca o con rosetta (specificare se destra o sinistra) / Half lever handle on plate or on rose (to specify if right or left)
- Maniglia con rosette senza bocchette / Lever handle on rose without rose for key
- Coppie impugnature (CM) con grano e ferro senza rosette e senza bocchette / Pair levers (CM) with grub screws and square pin without rose and without rose for key
- Cremonesi e martelline con impugnatura a maniglia (segretini)

art. 191 OVALINO

materiale: Ottone
material: Solid Brass

Brass Class
100% Ottone

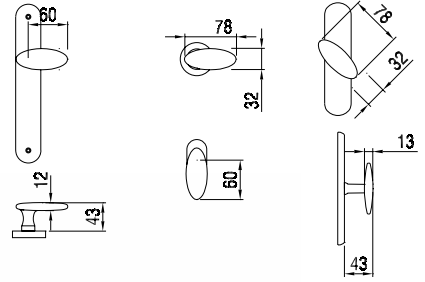

191 MR 006 LV



191 MR 007 LV



191 MR R40 AN



191 MR 202 AGV



191 MR 009 BG



191 MR 006 OSC



191 MR 006 OC



191 MP 159 LV



190 MA 137 LV
190 CR 137 LV



190 MA 007 LV



191 DK 025 LV



190 TK 015 LV



191 MA 007 LV

speciale
special
25



						LV	BG	OC OSC	AN	AGV	NR	
MANIGLIA CON PLACCA / LEVER HANDLE ON PLATE												
	191 MP 159	Maniglia con placca Lever Handle on plate	159	mm 231x35	con molla e grano with spring and grub screw	•		•				1
	191 MP 166	Maniglia con placca Lever Handle on plate	166	mm 242x33	con molla e grano with spring and grub screw	•			•	•		1
MANIGLIA CON ROSETTA / LEVER HANDLE ON ROSE												
	191 MR 003	Maniglia con rosetta Lever Handle on rose	003	mm Ø45x7	con molla e grano with spring and grub screw	•		•	•	•		2
	191 MR 006	Maniglia con rosetta Lever Handle on rose	006	mm Ø50x8	tipo lusso con molla e grano lusso type with spring and grub screw	•		•	•	•		2
	191 MR 007	Maniglia con rosetta Lever Handle on rose	007	mm 67x27	ovale stretta con grano oval and reduced with grub screw	•		•	•	•		2
	191 MR 009	Maniglia con rosetta Lever Handle on rose	009	mm 62x32	ovale con molla e grano oval with spring and grub screw	•		•				1
	191 MR R40	Maniglia con rosetta Lever Handle on rose	R40	mm Ø45x7	con fori viti a vista con grano with holes for screws with grub screw	•			•	•		2
	191 MR 202	Maniglia con rosetta Lever Handle on rose	202	mm Ø52x9	con bordo con grano with edge with grub screw	•			•	•		2
CREMONESE / WINDOW HANDLE WITH MECHANISM												
	190 CR 137*	Cremonese con placca Window Handle on plate	137	mm 167x40	con fori viti con gioco with holes for screws with mechanism	•		•				2
	190 CR 063	Cremonese con placca Window Handle on plate	063	mm 143x37	con gioco M.P. per aste esterne G.M.P for outside rods with mechanism	•		•	•	•	•	2
	190 CR 040*	Cremonese con placca Window Handle on plate	040	mm 174x37	con gioco with mechanism	•			•	•		2
MARTELLINA / WINDOW HANDLE WITHOUT MECHANISM												
	190 MA 137*	Martellina con placca Window Handle on plate	137	mm 167x40	con fori viti q.7 with holes for screws with square-pin mm 7	•		•				2
	190 MA 040*	Martellina con placca Window Handle on plate	040	mm 174x37	q.7 without mechanism with square-pin mm 7	•			•	•		2
	190 MA 007	Martellina con rosetta Window Handle on rose	007	mm 67x27	q.7 without mechanism with square-pin mm 7	•		•	•	•		6
	191 MA 007	Martellina con rosetta Window Handle on rose	007	mm 68x28	q.7 without mechanism with square-pin mm 7	•		•	•	•		6
DREH KIPP / DREH KIPP												
	191 DK 015	Dreh Kipp con rosetta Dreh Kipp on rose	015	mm 65x31	con movimento in metallo with metal mechanism	•		•	•	•		3
	190 TK 015	Dreh Kipp con rosetta Dreh Kipp on rose	015	mm 65x31	con impugnatura martellina a "T" shape "T"	•		•	•	•		3
	191 DK 025	Dreh Kipp con rosetta Dreh Kipp on rose	025	mm 65x25	stretta con movimento in metallo reduced with metal mechanism	•		•	•			3
	191 DK C67	Dreh Kipp con rosetta Safety DK on rose	C67	mm 69x33	c/chave e cilindro e mov. in metallo with key and cylinder and metal mec.	•		•	•	•		1

* Placca adatta a movimenti intercambiabili
Plate suitable to interchangeable movements



191 MP 166 AGV



191 DK 015 AN



191 DK C67 AGV

A RICHIESTA / ON REQUEST:

- Mezza maniglia con placca o con rosetta (specificare se destra o sinistra) / Half lever handle on plate or on rose (to specify if right or left)
- Maniglia con rosette senza bocchette / Lever handle on rose without rose for key
- Coppie impugnature (CM) con grano e ferro senza rosette e senza bocchette / Pair levers (CM) with grub screws and square pin without rose and without rose for key
- Cremonesi e martelline con impugnatura a maniglia (segretini)
- Cremonese e martellina con placca coprivite e movimento intercambiabile

art. 192 CLASS

design: Studio Reguitti
 materiale: Impugnatura Zama
 material: Lever Zamak

TeKnoMetal
 Linea in zama

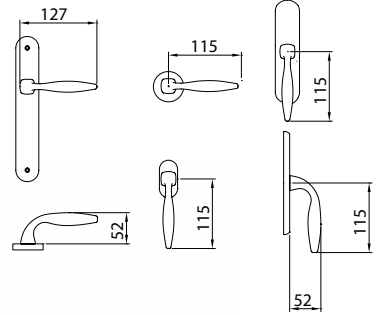

192 MR 006 ZSC



192 MR 416 PVD



192 MR 816 ZSC



192 MR Q86 ZSC



192 MR 916 ZSC



192 MR 9Q6 ZSC



192 MP 188 ZSC



192 DK 015 ZSC



192 DK Q15 ZSC

VERSIONI / VERSIONS



MANIGLIA CON PLACCA / LEVER HANDLE ON PLATE				ZSC ZCR	PVD		
	192 MP 188	Maniglia con placca Lever Handle on plate	188 mm 255x42	con molla e grano with spring and grub screw	•	•	1
	192 MP 130	Maniglia con placca Lever Handle on plate	130 mm 245x50	con molla e grano with spring and grub screw	•		1
MANIGLIA CON ROSETTA / LEVER HANDLE ON ROSE							
	192 MR 006	Maniglia con rosetta Lever Handle on rose	006 mm Ø50x8	tipo lusso con molla e grano lusso type with spring and grub screw	•	•	1
	192 MR 416	Maniglia con rosetta Lever Handle on rose	416 mm Ø45x9	con molla e grano with spring and grub screw	•	•	1
	192 MR 816	Maniglia con rosetta Lever Handle on rose	816 mm Ø50x10	con molla e grano with spring and grub screw	•	•	1
	192 MR 916	Maniglia con rosetta Lever Handle on rose	916 mm 62x32	ovale con molla e grano oval with spring and grub screw	•	•	1
	192 MR 9Q6	Maniglia con rosetta Lever Handle on rose	9Q6 mm 61x31	con molla e grano with spring and grub screw	•		1
	192 MR Q86	Maniglia con rosetta Lever Handle on rose	Q86 mm 50x50	con molla e grano with spring and grub screw	•		1
CREMONESE / WINDOW HANDLE WITH MECHANISM							
	192 SG 070*	Cremonese con placca Window Handle on plate	070 mm 189x36	coprivite con gioco with cover-screw plate with mechanism	•	•	2
	192 SG Q13*	Cremonese con placca Window Handle on plate	Q13 mm 160x33	coprivite con gioco with cover-screw plate with mechanism	•		2
MARTELLINA / WINDOW HANDLE WITHOUT MECHANISM							
	192 SE 070*	Martellina con placca Window Handle on plate	070 mm 189x36	coprivite q.7 with cover-screw plate with square-pin mm 7	•	•	2
	192 SE Q13*	Martellina con placca Window Handle on plate	Q13 mm 160x33	coprivite q.7 with cover-screw plate with square-pin mm 7	•		2
DREH KIPP / DREH KIPP							
	192 DK 015	Dreh Kipp con rosetta Dreh Kipp on rose	015 mm 65x31	con movimento in metallo with metal mechanism	•	•	3
	192 DK Q15	Dreh Kipp con rosetta Dreh Kipp on rose	Q15 mm 65x31	con movimento in metallo with metal mechanism	•		2
	192 DK C70	Dreh Kipp con rosetta Safety DK on rose	C70 mm 69x33	con chiave e cilindro e movimento in metallo with key and cylinder and metal mechanism	•	•	1

* Placca adatta a movimenti intercambiabili
Plate suitable to interchangeable movements



192 DK C70 ZSC

Per caratteristiche tecniche rosette vedi apposito capitolo soluzioni tecniche e componenti / For technical specifications rosettes see specific section technical solutions and components

A RICHIESTA / ON REQUEST:

- Mezza maniglia con placca o con rosetta (specificare se destra o sinistra) / Half lever handle on plate or on rose (to specify if right or left)
- Maniglia con rosette senza bocchette / Lever handle on rose without rose for key
- Coppie impugnature (CM) con grano e ferro senza rosette e senza bocchette / Pair levers (CM) with grub screws and square pin without rose and without rose for key

art. 194 Q-LINE

design: Studio Reguitti
 materiale: Impugnatura Zama
 material: Lever Zamak

TeKnoMetal
 Linea in zama

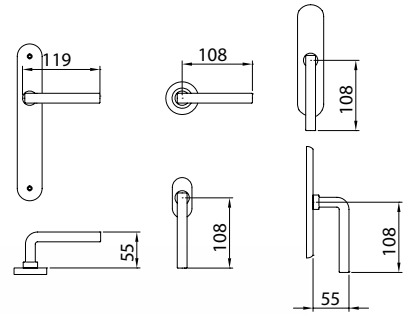

194 MR Q08 ZSC



194 MR 416 ZSC



194 MR Q08 SNV



194 MR Q08 ZCR



194 MR Q09 ZSC



194 MP 130 ZSC



194 DK 015 ZSC
 194 DK 024 ZSC



194 DK Q15 ZSC

VERSIONI / VERSIONS



Finiture
Finishes

ZSC
ZCR

SNV



MANIGLIA CON PLACCA / LEVER HANDLE ON PLATE

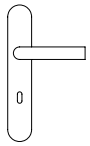

194 MP 188	Maniglia con placca Lever Handle on plate	188 mm 255x42	con molla e grano with spring and grub screw	•	•	1
194 MP 130	Maniglia con placca Lever Handle on plate	130 mm 245x50	con molla e grano with spring and grub screw	•	•	1

MANIGLIA CON ROSETTA / LEVER HANDLE ON ROSE



194 MR 005	Maniglia con rosetta Lever Handle on rose	005 mm Ø50x8	tipo lusso con molla e grano luxu type with spring and grub screw	•	•	1
194 MR 416	Maniglia con rosetta Lever Handle on rose	416 mm Ø45x9	con molla e grano with spring and grub screw	•	•	1
194 MR 816	Maniglia con rosetta Lever Handle on rose	816 mm Ø50x10	con molla e grano with spring and grub screw	•	•	1
194 MR Q09	Maniglia con rosetta Lever Handle on rose	Q09 mm 61x31	con molla e grano with spring and grub screw	•	•	1
194 MR Q05-71	Maniglia con rosetta Lever Handle on rose	Q05 mm 50x50	lusso con molla e grano con bocchetta Q08 luxu type w/spring, grub screw, rose for key Q08	•	•	1
194 MR Q05-72	Maniglia con rosetta Lever Handle on rose	Q05 mm 50x50	lusso con molla e grano con bocchetta Q08 yale luxu type w/spring, grub screw, rose for key Q08 yale	•	•	1
194 MR Q08	Maniglia con rosetta Lever Handle on rose	Q08 mm 50x50	con molla e grano with spring and grub screw	•	•	1

CREMONESE / WINDOW HANDLE WITH MECHANISM



194 SG 070*	Cremonese con placca Window Handle on plate	070 mm 189x36	coprivite con gioco with cover-screw plate with mechanism	•	•	2
194 SG Q13*	Cremonese con placca Window Handle on plate	Q13 mm 160x33	coprivite con gioco with cover-screw plate with mechanism	•	•	2

MARTELLINA / WINDOW HANDLE WITHOUT MECHANISM



194 SE 070*	Martellina con placca Window Handle on plate	070 mm 189x36	coprivite q.7 with cover-screw plate with square-pin mm 7	•	•	2
194 SE Q13*	Martellina con placca Window Handle on plate	Q13 mm 160x33	coprivite q.7 with cover-screw plate with square-pin mm 7	•	•	2

DREH KIPP / DREH KIPP

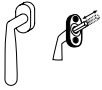

194 DK 024	Dreh Kipp con rosetta Dreh Kipp on rose	024 mm 65x31	con mov. in metallo e quadro autoregolante with metal mec. and adjustable square-pin	•	•	3
194 DK Q15	Dreh Kipp con rosetta Dreh Kipp on rose	Q15 mm 65x31	con movimento in metallo with metal mechanism	•	•	3

* Placca adatta a movimenti intercambiabili
Plate suitable to interchangeable movements



194 MR Q05-71 ZSC
Sottorosea in metallo



194 MP 188 ZSC

Per caratteristiche tecniche rosette vedi apposito capitolo soluzioni tecniche e componenti / For technical specifications rosettes see specific section technical solutions and components

A RICHIESTA / ON REQUEST:

- Mezza maniglia con placca o con rosetta (specificare se destra o sinistra) / Half lever handle on plate or on rose (to specify if right or left)
- Maniglia con rosette senza bocchette / Lever handle on rose without rose for key
- Coppie impugnature (CM) con grano e ferro senza rosette e senza bocchette / Pair levers (CM) with grub screws and square pin without rose and without rose for key

art. 195 B-LINE

design: Studio Reguitti
 materiale: Impugnatura Zama
 material: Lever Zamak

TeKnoMetal
 Linea in zama

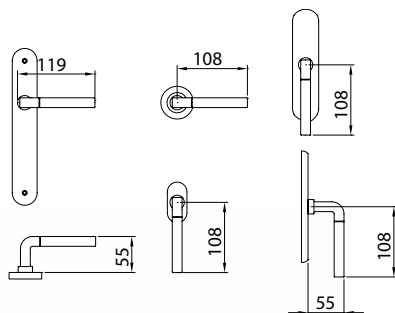

195 MR 416 ZSC/ZCR/OSC



195 MR 005 ZSC/ZCR/OSC



195 MR Q08 ZSC/ZCR



195 MR Q09 ZSC/ZCR



195 MP 130 ZSC/ZCR/OSC



195 DK 015 ZSC/ZCR
 195 DK 024 ZSC/ZCR



195 DK Q15 ZSC/ZCR/OSC



MANIGLIA CON PLACCA / LEVER HANDLE ON PLATE

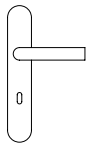

195 MP 188	Maniglia con placca Lever Handle on plate	188 mm 255x42	con molla e grano with spring and grub screw	•	•	1
195 MP 130	Maniglia con placca Lever Handle on plate	130 mm 245x50	con molla e grano with spring and grub screw	•	•	1

MANIGLIA CON ROSETTA / LEVER HANDLE ON ROSE



195 MR 005	Maniglia con rosetta Lever Handle on rose	005 mm Ø50x8	tipo lusso con molla e grano luxu type with spring and grub screw	•	•	1
195 MR 416	Maniglia con rosetta Lever Handle on rose	416 mm Ø45x9	con molla e grano with spring and grub screw	•	•	1
195 MR 816	Maniglia con rosetta Lever Handle on rose	816 mm Ø50x10	con molla e grano with spring and grub screw	•	•	1
195 MR Q09	Maniglia con rosetta Lever Handle on rose	Q09 mm 61x31	con molla e grano with spring and grub screw	•	•	1
195 MRQ05-71	Maniglia con rosetta Lever Handle on rose	Q05 mm 50x50	lusso con molla e grano con bocchetta Q08 luxu type w/spring, grub screw, rose for key Q08	•	•	1
195 MRQ05-72	Maniglia con rosetta Lever Handle on rose	Q05 mm 50x50	lusso con molla e grano con bocchetta Q08 yale luxu type w/spring, grub screw, rose for key Q08 yale	•	•	1
195 MR Q08	Maniglia con rosetta Lever Handle on rose	Q08 mm 50x50	con molla e grano with spring and grub screw	•	•	1

CREMONESE / WINDOW HANDLE WITH MECHANISM



195 SG 070*	Cremonese con placca Window Handle on plate	070 mm 189x36	coprivite con gioco with cover-screw plate with mechanism	•	•	2
195 SG Q13*	Cremonese con placca Window Handle on plate	Q13 mm 160x33	coprivite con gioco with cover-screw plate with mechanism	•	•	2

MARTELLINA / WINDOW HANDLE WITHOUT MECHANISM



195 SE 070*	Martellina con placca Window Handle on plate	070 mm 189x36	coprivite q.7 with cover-screw plate with square-pin mm 7	•	•	2
195 SE Q13*	Martellina con placca Window Handle on plate	Q13 mm 160x33	coprivite q.7 with cover-screw plate with square-pin mm 7	•	•	2

DREH KIPP / DREH KIPP



195 DK 024	Dreh Kipp con rosetta Dreh Kipp on rose	024 mm 65x31	con mov. in metallo e quadro autoregolante with metal mec. and adjustable square-pin	•	•	3
195 DK Q15	Dreh Kipp con rosetta Dreh Kipp on rose	Q15 mm 65x31	con movimento in metallo with metal mechanism	•	•	3

* Placca adatta a movimenti intercambiabili
Plate suitable to interchangeable movements



195MR Q05-72 ZSC/ZCR/OSC
Sottorosetta in metallo



195 MP 188 ZSC/ZCR/OSC

Per caratteristiche tecniche rosette vedi apposito capitolo soluzioni tecniche e componenti / For technical specifications rosettes see specific section technical solutions and components

A RICHIESTA / ON REQUEST:

- Mezza maniglia con placca o con rosetta (specificare se destra o sinistra) / Half lever handle on plate or on rose (to specify if right or left)
- Maniglia con rosette senza bocchette / Lever handle on rose without rose for key
- Coppie impugnature (CM) con grano e ferro senza rosette e senza bocchette / Pair levers (CM) with grub screws and square pin without rose and without rose for key

art. 196 SHUT

design: Studio Reguitti
materiale: Ottone
material: Solid Brass

Brass Class
100% Ottone

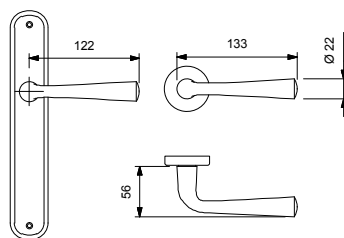

196 MR 416 - OSC



196 MR 006 - LV



196 MR 007 - BG



196 MR 916 - OSC



196 MR Q08 - OC



196 SE 070 - OSC
196 SG 070 - OSC



196 MP 188 - OC



196 DK Q15 - OSC



196 DK 015 - OC
196 DK 024 - OC



196 DK 075 - OSC

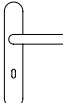

MANIGLIA CON PLACCA / LEVER HANDLE ON PLATE

				€	€		
	196 MP 026	Maniglia con placca Lever handle on plate	026 mm 225x26	"stretta" "reduced"	•	•	1
	196 MP 188	Maniglia con placca Lever handle on plate	188 mm 255x42	con molla with spring	•	•	1

MANIGLIA CON ROSETTA / LEVER HANDLE ON ROSE

					€	€	
	196 MR 004	Maniglia con rosetta Lever handle on rose	004 mm Ø45x9	con molla with spring	•	•	1
	196 MR 006	Maniglia con rosetta Lever handle on rose	006 mm Ø50x8	tipo lusso con molla lusso type with spring	•	•	1
	196 MR 007	Maniglia con rosetta Lever handle on rose	007 mm 67x27	ovale stretta oval and reduced	•	•	2
	196 MR 008	Maniglia con rosetta Lever handle on rose	008 mm Ø50x8	con molla with spring	•	•	1
	196 MR 416	Maniglia con rosetta Lever handle on rose	416 mm Ø45x9	con molla with spring	•	•	1
	196 MR 816	Maniglia con rosetta Lever handle on rose	816 mm Ø50x10	con molla with spring	•	•	1
	196 MR 916	Maniglia con rosetta Lever handle on rose	916 mm 62x32	ovale con molla oval with spring	•	•	1
	196 MR 9Q6	Maniglia con rosetta Lever handle on rose	9Q6 mm 61x31	con molla with spring	•	•	1
	196 MR Q05-71	Maniglia con rosetta Lever handle on rose	Q05 mm 50x50	Base in metallo con molla e bocc. Q08 Internal metal - spring and Q08 key rose	•	•	1
	196 MR Q08	Maniglia con rosetta Lever handle on rose	Q08 mm 50x50	con molla with spring	•	•	1
	196 MR Q46	Maniglia con rosetta Lever handle on rose	Q46 mm 45x45	con molla with spring	•	•	1



MARTELLINA / WINDOW HANDLE WITHOUT MECHANISM

					€	€	
	196 SE 070*	Martellina con placca Martellina on plate	070 mm 189x36	coprivite q.7 with cover-screw plate and sq.-pin mm 7	•	•	2
	196 SE Q13*	Martellina con placca Martellina on plate	Q13 mm 160x33	coprivite q.7 with cov.scr.plate and sq.-pin mm 7	•	•	2
	196 SE Q90*	Martellina con placca Martellina on plate	Q90 mm 190x38	coprivite q.7 with cov.scr.plate and sq.-pin mm 7	•	•	2

CREMONESE / WINDOW HANDLE WITH MECHANISM

					€	€	
	196 SG 070*	Cremonese con placca Cremon on plate	070 mm 189x36	coprivite con gioco with cover-screw plate with mechanism	•	•	2
	196 SG Q13*	Cremonese con placca Cremon on plate	Q13 mm 160x33	coprivite con gioco with cover-screw plate with mechanism	•	•	2
	196 SG Q90*	Cremonese con placca Cremon on plate	Q90 mm 190x38	coprivite con gioco with cover-screw plate with mechanism	•	•	2

DREH KIPP / DREH KIPP

					€	€	
	196 DK 015	Dreh kipp con rosetta Dreh Kipp on rose	015 mm 65x31	con movimento in metallo with metal mechanism	•	•	3
	196 DK 024	Dreh kipp con rosetta Dreh Kipp on rose	024 mm 65x31	con mov. in metallo, quadro autoregolante with metal mec. and adjustable sq.-pin	•	•	3
	196 DK 075	Dreh kipp con rosetta Dreh Kipp on rose	075 mm 64x30	con mov. securblock e puls. di sicurezza with securblock system and push button	•	•	2
	196 DK C67	Dreh kipp con rosetta Safety DK on rose	C67 mm 69x33	con chiave e cilindro e mov. in metallo with key-cylinder and metal mechanism	•	•	1
	196 DK Q15	Dreh kipp con rosetta Dreh Kipp on rose	Q15 mm 65x31	con movimento in metallo with metal mechanism	•	•	3
	196 DK Q75	Dreh kipp con rosetta Dreh Kipp on rose	Q75 mm 64x30	con mov. securblock e puls. di sicurezza with securblock system and push button	•	•	2

Per caratteristiche tecniche rosette vedi apposito capitolo soluzioni tecniche e componenti / For technical specifications rosettes see specific section technical solutions and components

art. 197 ARJA

design: Studio Reguitti
materiale: Ottone
material: Solid Brass

Brass Class
100% Ottone

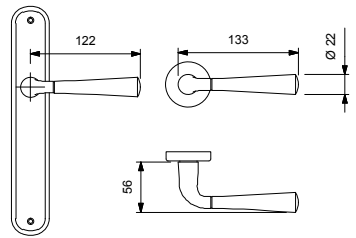

197 MR 416 - OSC/OC



197 SE 070 - OSC/OC
197 SG 070 - OSC/OC



197 MP 188 - OSC/OC



197 MR 006 - OSC/OC



197 MR 916 - OS/LV



197 MR Q08 - OSC/OC



197 DK Q15 - OSC/OC



197 DK 015 - OSC/OC
197 DK 024 - OSC/OC







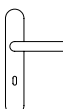

197 DK C67 - OS/LV



MANIGLIA CON PLACCA / LEVER HANDLE ON PLATE

				€	€	
	197 MP 026	Maniglia con placca Lever handle on plate	026 mm 225x26 "stretta" "reduced"	•	•	1
	197 MP 188	Maniglia con placca Lever handle on plate	188 mm 255x42 con molla with spring	•	•	1

MANIGLIA CON ROSETTA / LEVER HANDLE ON ROSE

				€	€	
	197 MR 004	Maniglia con rosetta Lever handle on rose	004 mm Ø45x9 con molla with spring	•	•	1
	197 MR 006	Maniglia con rosetta Lever handle on rose	006 mm Ø50x8 tipo lusso con molla lusso type with spring	•	•	1
	197 MR 007	Maniglia con rosetta Lever handle on rose	007 mm 67x27 ovale stretta oval and reduced	•	•	2
	197 MR 008	Maniglia con rosetta Lever handle on rose	008 mm Ø50x8 con molla with spring	•	•	1
	197 MR 416	Maniglia con rosetta Lever handle on rose	416 mm Ø45x9 con molla with spring	•	•	1
	197 MR 816	Maniglia con rosetta Lever handle on rose	816 mm Ø50x10 con molla with spring	•	•	1
	197 MR 916	Maniglia con rosetta Lever handle on rose	916 mm 62x32 ovale con molla oval with spring	•	•	1
	197 MR 9Q6	Maniglia con rosetta Lever handle on rose	9Q6 mm 61x31 con molla with spring	•	•	1
	197 MR Q05-71	Maniglia con rosetta Lever handle on rose	Q05 mm 50x50 Base in metallo con molla e bocc. Q08 Internal metal - spring and Q08 key rose	•	•	1
	197 MR Q08	Maniglia con rosetta Lever handle on rose	Q08 mm 50x50 con molla with spring	•	•	1
	197 MR Q46	Maniglia con rosetta Lever handle on rose	Q46 mm 45x45 con molla with spring	•	•	1



MARTELLINA / WINDOW HANDLE WITHOUT MECHANISM

				€	€	
	197 SE 070*	Martellina con placca Martellina on plate	070 mm 189x36 coprivite q.7 with cover-screw plate and sq.-pin mm 7	•	•	2
	197 SE Q13*	Martellina con placca Martellina on plate	Q13 mm 160x33 coprivite q.7 with cov.scr.plate and sq.-pin mm 7	•	•	2
	197 SE Q90*	Martellina con placca Martellina on plate	Q90 mm 190x38 coprivite q.7 with cov.scr.plate and sq.-pin mm 7	•	•	2

CREMONESE / WINDOW HANDLE WITH MECHANISM

				€		
	197 SG 070*	Cremonese con placca Cremon on plate	070 mm 189x36 coprivite con gioco with cover-screw plate with mechanism	•	•	2
	197 SG Q13*	Cremonese con placca Cremon on plate	Q13 mm 160x33 coprivite con gioco with cover-screw plate with mechanism	•	•	2
	197 SG Q90*	Cremonese con placca Cremon on plate	Q90 mm 190x38 coprivite con gioco with cover-screw plate with mechanism	•	•	2

DREH KIPP / DREH KIPP

				€	€	
	197 DK 015	Dreh kipp con rosetta Dreh Kipp on rose	015 mm 65x31 con movimento in metallo with metal mechanism	•	•	3
	197 DK 024	Dreh kipp con rosetta Dreh Kipp on rose	024 mm 65x31 con mov. in metallo, quadro autoregolante with metal mec. and adjustable sq.-pin	•	•	3
	197 DK 075	Dreh kipp con rosetta Dreh Kipp on rose	075 mm 64x30 con mov. securblock e puls. di sicurezza with securblock system and push button	•	•	2
	197 DK C67	Dreh kipp con rosetta Safety DK on rose	C67 mm 69x33 con chiave e cilindro e mov. in metallo with key-cylinder and metal mechanism	•	•	1
	197 DK Q15	Dreh kipp con rosetta Dreh Kipp on rose	Q15 mm 65x31 con movimento in metallo with metal mechanism	•	•	2
	197 DK Q75	Dreh kipp con rosetta Dreh Kipp on rose	Q75 mm 64x30 con mov. securblock e puls. di sicurezza with securblock system and push button	•	•	2

Per caratteristiche tecniche rosette vedi apposito capitolo soluzioni tecniche e componenti / For technical specifications rosettes see specific section technical solutions and components

art. 199 UNIQA

design: St. Reguitti - Mod.Dep.
 materiale: Impugnatura Zama
 material: Lever Zamak

TeKnoMetal
 Linea in zama



RPM SYSTEM



DIMENSIONI MAGGIORATE FINO AL 50% RISPETTO A MANIGLIE TRADIZIONALI.
 LETTERALMENTE UNA GRANDE MANIGLIA CREATA PER DARE MAGGIOR VALORE ALLA PORTA.

DESIGN MINIMALE MA DI EFFETTO.

UN PRODOTTO SEMPLICE, MODERNO MA PIÙ IMPORTANTE.

Increased size of up to 50% compared to traditional handles.

An OVERSIZED HANDLE properly designed to give better value to the door.

Minimal design but effective.

A simple, modern but more important product

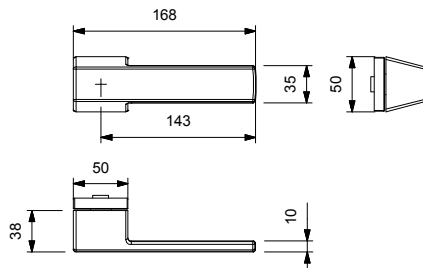

199 MR 199 - ZSC



199 RQ 199 - ZSC



199 SE Q90 - ZSC
 199 SG Q90 - ZSC



199 DK Q15 - ZSC



199 DK Q75 - ZSC



MANIGLIA CON ROSETTA / LEVER HANDLE ON ROSE

					ZCR ZSC	SNV	PVD INOX	
					€	€	€	
	199 MR 199-71	Maniglia con rosetta Lever handle on rose	199 mm 50x50	RPM system c/molla e bocc.Q08 RPM system with spring and Q08 ros.for key	•	•	•	1
	199 MR 199-72	Maniglia con rosetta Lever handle on rose	199 mm 50x50	RPM system c/molla e bocc.Q08 yale RPM system with spring and Q08 yale	•	•	•	1
	199 MR 199-35	Maniglia con rosetta Lever handle on rose	199 mm 50x50	RPM system c/molla senza bocc. RPM system with spring without key rose	•	•	1•	1

MANIGLIA CON ROSETTA E NOTTOLINO WC / LEVER HANDLE ON ROSE AND WC TURN

					€	€	€	
					€	€	€	
	199 RQ 199	Maniglia con rosetta Lever handle on rose	199 mm 50x50	RPM system e nott. wc 124 with RPM system and wc turn 124	•	•	•	1

MARTELLINA / WINDOW HANDLE WITHOUT MECHANISM

					€	€	€	
					€	€	€	
	199 SE Q90*	Martellina con placca Martellina on plate	Q90 mm 190x38	coprivite q.7 with cov.scr.plate and sq.-pin mm 7	•	•	•	2

CREMONESE / WINDOW HANDLE WITH MECHANISM

					€	€	€	
					€	€	€	
	199 SG Q90*	Cremonese con placca Cremon on plate	Q90 mm 190x38	coprivite con gioco with cover-screw plate with mechanism	•	•	•	2

DREH KIPP / DREH KIPP

					€	€	€	
					€	€	€	
	199 DK Q15	Dreh kipp con rosetta Dreh Kipp on rose	Q15 mm 65x31	con movimento in metallo with metal mechanism	•	•	•	2
	199 DK Q75	Dreh kipp con rosetta Dreh Kipp on rose	Q75 mm 64x30	con mov. securblock e puls. di sicurezza with securblock system and push button	•	•	•	2

L'ergonomia speciale di UNIQA
Special ergonomics of UNIQA



L'ergonomia delle dimensioni tradizionali
Ergonomics of common sizes



A RICHIESTA / ON REQUEST:

- Mezza maniglia con placca o con rosetta (specificare se destra o sinistra) / Half lever handle on plate or on rose (to specify if right or left)
- Coppie impugnature (CM) con grano e ferro senza rosette e senza bocchette / Pair levers (CM) with grub screws and square pin without rose and without rose for key

art. 199 UNIQA maniglia senza bocchette









Finiture
Finishes

			ZCR ZSC €	SNV €	PVD INOX €
	199 MR 199	Maniglia con rosetta 199 mm 50x50 senza bocchetta Lever handle on rose 199 mm 50x50 without key rose	•	•	1•
	Q08 BN	Bocchetta quadra con foro chiave Square rose with key hole	mm 50x50	pz. 1 •	pz. 1 •
	Q08 BY	Bocchetta quadra con foro yale Square rose with euro profile cylinder (yale)	mm 50x50	pz. 1 •	pz. 1 •
	124 NO QN6	Nottolino 124 libero/occupato per wc con rosetta QN6 Wc turn 124 and release on QN6 rose	mm 50x50	1 set •	1 set •
	Q22 BN	Bocchetta MINIMAL LINE quadra MINIMAL LINE square key rose	mm 25x25	pz. 1 •	pz. 1 •
	Q22 BY	Bocchetta rettangolare YALE MINIMAL LINE MINIMAL LINE rectangular rose for euro profile cylinder (yale)	mm 25x40	pz. 1 •	pz. 1 •
	124 NO Q22	Nottolino 124 libero/occupato per wc con rosetta quadra Q22 MINIMAL LINE Wc turn 124 and release on Q22 square rose	mm 25x25	1 set •	1 set •

art. 199 UNIQA - lever handle without key roses



		Finish Finishes	ZCR ZSC €	SNV €	PVD INOX €
	022 BN	Bocchetta MINIMAL LINE tonda MINIMAL LINE round key rose Ø mm 25	pz. 1 •	pz. 1 •	pz. 1 •
	022 BY	Bocchetta ovale YALE MINIMAL LINE MINIMAL LINE oval rose for euro profile cylinder (yale) mm 25x40	pz. 1 •	pz. 1 •	pz. 1 •
	503 NO 022	Nottolino 503 libero/occupato per wc con rosetta tonda 022 MINIMAL LINE Wc turn 503 and release on 022 round rose Ø mm 25	1 set •	1 set •	1 set •
	CD JQ8 BN	Set 2 bocchette quadre FLAT LINE Set 2 FLAT LINE square roses for key mm 55x55	1 set •	1 set •	1 set •
	CD JQ8 BY	Set 2 bocchette YALE quadre FLAT LINE Set 2 FLAT LINE square roses for euro profile cylinder hole (yale) mm 55x55	1 set •	1 set •	1 set •
	124 NO JQ8	Nottolino 124 libero/occupato per wc con rosetta quadra FLAT LINE Wc turn 124 and release on square rose FLAT LINE mm 55x55	1 set •	1 set •	1 set •



Finiture
Finishes

OC
OSC
€

	<p>425 MS Q02</p> <p>Maniglione singolo inclusi accessori per il montaggio singolo per legno (montaggio P) e accoppiato per legno e vetro (montaggio AC) <i>Single pull handle, including accessories for single on wood door (type P) and back to back (type AC) pull handle , on wooden and glass door</i></p>	•
	<p>124 PF Q08</p> <p>Pomolo Fisso con rosetta Q08 mm con piastrina <i>Fixed Knob on rose 50X50 with fixing base</i></p>	•
	<p>355 PF Q08</p> <p>Pomolo Fisso con rosetta Q08 mm con piastrina <i>Fixed Knob on rose 50X50 with fixing base</i></p>	•
	<p>124 BA</p> <p>Battente <i>Door Knocker</i></p>	•
	<p>124 MD Q01</p> <p>Maniglione singolo su placca cieca e con nicchia <i>Single Pull Handle on blind plate with fl ush pull plate</i></p>	•
	<p>Q24 PI</p> <p>Placca incasso quadra <i>Square sliding door plate</i></p>	•
	<p>873 CP 00Q</p> <p>Coppia placche incasso <i>Pair sliding door plate</i></p>	•



Finiture
Finishes

OC
OSC
€

Posizione foro variabile
Hole position variable

Q65 KP

Placca per maniglia mm 265x42
SPECIALE PER SOSTITUZIONI
Plate for door handle 265x42 mm
SPECIAL FOR REPLACEMENTS



Q51 PI

Placca incasso con pendente di presa
Door edge flush pull handle
(In fase di realizzazione)
(Product under construction)

•

Q09 BY

Bocchetta rettangolare coprivite mm 61x31 con foro yale
Rectangular Cover screw rose mm 61x31 euro profile
cylinder hole (yale)

•

CD Q06

Set bocchette di sicurezza rettangolari mm 92x35 con protezione cilindro regolabile
e 2 viti passanti M6 completo di sottobocchetta in acciaio speciale
temprato antitrapano
Rectangular safety escutcheon mm 92x35 with euro cylinder protection adjustable
and 2 screws door through M6 - internal steel hardened protection rose

•

CD Q02

Set bocchette quadrate di sicurezza con protezione cilindro regolabile e
2 viti passanti M5 interasse mm 38-completo di sottobocchetta in acciaio
speciale temprato antitrapano
Safety escutcheon with euro cylinder protection adjustable and 2 screws door
through M5 center to center mm 38-internal steel hardened protection rose

•

503 NO FQ8

Nott. libero/occupato per wc con rosetta e indicatore
Wc turn and release on rose with indicator

•

CQ8 RO

Bocchetta c/foro asse per cilindro con codolo
Rose for cylinders with tang

•

Q30 TP

Spioncino Q-SPY quadro mm 30x30
Square door viewer mm 30x30

•

646 TP

mm 120x55

•

647 TP

Targhetta portanome
Nameplate

mm 170x70

•

124 PN 025

Pomolino quadrato mm 25X25
Furniture Square Knob mm 25X25

•

art. 223 LAPIA

(="CIAO" nella lingua del Ciad /
"HALLO" in Tchad language)

design: Studio Reguitti
materiale: Ottone
material: Solid Brass

Brass Class
100% Ottone

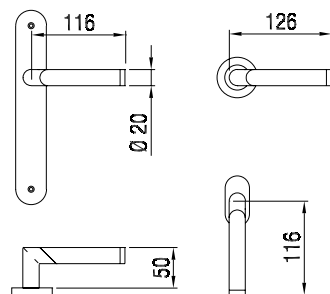

223 MR 006 OSC/OC



223 MR 006 OS/LV



223 MR 006 INOX SAT/OC



223 MP 188 OS/LV



223 DK 015 OS/LV

VERSIONI / VERSIONS



Finiture
Finishes

MANIGLIA CON PLACCA / LEVER HANDLE ON PLATE

	OS/LV	NR/OSC NR/OC	OC/LV OSC/OC	INOX SAT/OC	
223 MP 188 Maniglia con placca / Lever Handle on plate 188 mm 255x42 con molla e grano / with spring and grub screw	•	•	•	•	1

MANIGLIA CON ROSETTA / LEVER HANDLE ON ROSE

223 MR 006 Maniglia con rosetta / Lever Handle on rose 006 mm Ø50x8 tipo lusso con molla e grano / lusso type with spring and grub screw	•	•	•	•	1
--	---	---	---	---	---



223 MR 416 Maniglia con rosetta / Lever Handle on rose 416 mm Ø45x9 con molla e grano / with spring and grub screw	•	•	•	•	1
--	---	---	---	---	---

CREMONESE / WINDOW HANDLE WITH MECHANISM

223 SG 070* Cremonese con placca / Window Handle on plate 070 mm 189x36 coprivite con gioco / with cover-screw plate with mechanism	•	•	•	•	2
---	---	---	---	---	---

MARTELLINA / WINDOW HANDLE WITHOUT MECHANISM

223 SE 070* Martellina con placca / Window Handle on plate 070 mm 189x36 coprivite q.7 / with cover-screw plate with square-pin mm 7	•	•	•	•	2
--	---	---	---	---	---

DREH KIPP / DREH KIPP

223 DK 015 Dreh Kipp con rosetta / Dreh Kipp on rose 015 mm 65x31 con movimento in metallo / with metal mechanism	•	•	•	•	3
---	---	---	---	---	---

* Placca adatta a movimenti intercambiabili - Plate suitable to interchangeable movements

Per caratteristiche tecniche rosette vedi apposito capitolo soluzioni tecniche e componenti / For technical specifications rosettes see specific section technical solutions and components

A RICHIESTA / ON REQUEST:

- Mezza maniglia con placca o con rosetta (specificare se destra o sinistra) / Half lever handle on plate or on rose (to specify if right or left)
- Maniglia con rosette senza bocchette / Lever handle on rose without rose for key
- Coppie impugnature (CM) con grano e ferro senza rosette e senza bocchette / Pair levers (CM) with grub screws and square pin without rose and without rose for key

art. 224 GLORY

design: Studio Reguitti
materiale: Ottone
material: Solid Brass

Brass Class
100% Ottone

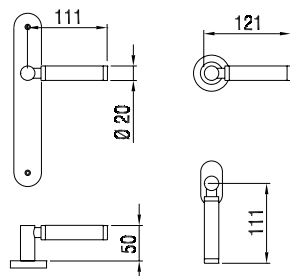

224 MR 416 OSC/OC



224 MR 005 INOX SAT/OC



224 MR 005 OC/LV



224 MP 188 OS/LV



224 DK 015 OS/LV

VERSIONI / VERSIONS



Finiture
Finishes

MANIGLIA CON PLACCA / LEVER HANDLE ON PLATE

224 MP 188 Maniglia con placca 188 mm 255x42 con molla e grano
Lever Handle on plate with spring and grub screw

OS/LV	NR/OSC NR/OC	OC/LV OSC/OC	INOX SAT/OC	
•	•	•	•	1

MANIGLIA CON ROSETTA / LEVER HANDLE ON ROSE

224 MR 005 Maniglia con rosetta 005 mm Ø50x8 tipo lusso con molla e grano
Lever Handle on rose lusso type with spring and grub screw

•	•	•	•	1
---	---	---	---	---



224 MR 416 Maniglia con rosetta 416 mm Ø45x9 con molla e grano
Lever Handle on rose with spring and grub screw

•	•	•	•	1
---	---	---	---	---

CREMONESE / WINDOW HANDLE WITH MECHANISM

224 SG 070* Cremonese con placca 070 mm 189x36 coprivite con gioco
Window Handle on plate with cover-screw plate with mechanism

•	•	•	•	2
---	---	---	---	---

MARTELLINA / WINDOW HANDLE WITHOUT MECHANISM

224 SE 070* Martellina con placca 070 mm 189x36 coprivite q.7
Window Handle on plate with cover-screw plate with square-pin mm. 7

•	•	•	•	2
---	---	---	---	---

DREH KIPP / DREH KIPP

224 DK 015 Dreh Kipp con rosetta 015 mm 65x31 con movimento in metallo
Dreh Kipp on rose with metal mechanism

•	•	•	•	3
---	---	---	---	---

* Placca adatta a movimenti intercambiabili - Plate suitable to interchangeable movements

Per caratteristiche tecniche rosette vedi apposito capitolo soluzioni tecniche e componenti / For technical specifications rosettes see specific section technical solutions and components

A RICHIESTA / ON REQUEST:

- Mezza maniglia con placca o con rosetta (specificare se destra o sinistra) / Half lever handle on plate or on rose (to specify if right or left)
- Maniglia con rosette senza bocchette / Lever handle on rose without rose for key
- Coppie impugnature (CM) con grano e ferro senza rosette e senza bocchette / Pair levers (CM) with grub screws and square pin without rose and without rose for key

art. 225 MIRIAM

materiale: Ottone
material: Solid Brass

Brass Class
100% Ottone

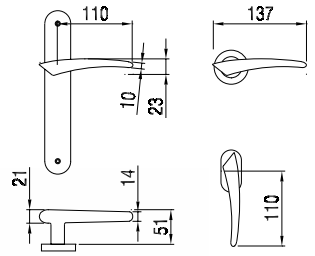

225 MR 006 LV



225 MR 009 OC



225 MR 816 OS



225 MR 416 OSC



225 MR 006 OC



225 MR 006 OS



225 MR 006 OSC



225 MR 006 BG



225 MP 188 LV

destra/right



225 SE 070 LV
225 SG 070 LV

destra/right



225 DK 015 LV

VERSIONI / VERSIONS



Finiture
Finishes

					LV	BG	OS	OSC OC	
MANIGLIA CON PLACCA / LEVER HANDLE ON PLATE									
	225 MP 188	Maniglia con placca Lever Handle on plate	188	mm 255x42	con molla e grano with spring and grub screw	•		•	1
	225 MP 130	Maniglia con placca Lever Handle on plate	130	mm 245x50	con molla e grano with spring and grub screw	•		•	1
	225 MP 248	Maniglia con placca Lever Handle on plate	248	mm 248x50	con molla e grano with spring and grub screw	•		•	1
MANIGLIA CON ROSETTA / LEVER HANDLE ON ROSE									
	225 MR 006	Maniglia con rosetta Lever Handle on rose	006	mm Ø50x8	tipo lusso con molla e grano luxu type with spring and grub screw	•		•	1
	225 MR 008	Maniglia con rosetta Lever Handle on rose	008	mm Ø50x8	con molla e grano with spring and grub screw	•		•	1
	225 MR 009	Maniglia con rosetta Lever Handle on rose	009	mm 62x32	ovale con molla e grano oval with spring and grub screw	•		•	1
	225 MR 416	Maniglia con rosetta Lever Handle on rose	416	mm Ø45x9	con molla e grano with spring and grub screw	•		•	1
	225 MR 816	Maniglia con rosetta Lever Handle on rose	816	mm Ø50x10	con molla e grano with spring and grub screw	•		•	1
CREMONESE / WINDOW HANDLE WITH MECHANISM									
	225 SG 070*	Cremonese con placca Window Handle on plate	070	mm 189x36	coprivite con gioco with cover-screw plate with mechanism	•		•	2
MARTELLINA / WINDOW HANDLE WITHOUT MECHANISM									
	225 SE 070*	Martellina con placca Window Handle on plate	070	mm 189x36	coprivite q.7 with cover-screw plate with square-pin mm. 7	•		•	2
DREH KIPP / DREH KIPP									
	225 DK 015	Dreh Kipp destro con rosetta Dreh Kipp (right) on rose	015	mm 65x31	con movimento in metallo with metal mechanism	•		•	3

* Placca adatta a movimenti intercambiabili
Plate suitable to interchangeable movements



225 MP 248 LV



225 MP 130 OSC

Per caratteristiche tecniche rosette vedi apposito capitolo soluzioni tecniche e componenti / For technical specifications rosettes see specific section technical solutions and components

A RICHIESTA / ON REQUEST:

- Mezza maniglia con placca o con rosetta (specificare se destra o sinistra) / Half lever handle on plate or on rose (to specify if right or left)
- Maniglia con rosette senza bocchette / Lever handle on rose without rose for key
- Coppie impugnature (CM) con grano e ferro senza rosette e senza bocchette / Pair levers (CM) with grub screws and square pin without rose and without rose for key

art. 226 GAIA

materiale: Ottone
material: Solid Brass

Brass Class
100% Ottone

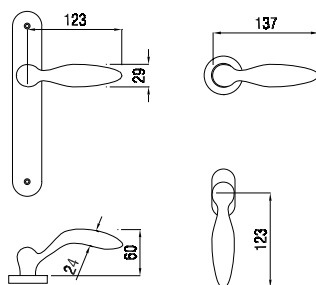

226 MR 009 OSC



226 MR 416 OSC



226 MR 006 LV



226 DK 015 LV

226 MP 188 LV

VERSIONI / VERSIONS



Finiture
Finishes

LV
OS

OC
OSC



MANIGLIA CON PLACCA / LEVER HANDLE ON PLATE

226 MP 188 Maniglia con placca 188 mm 255x42 con molla e grano
Lever Handle on plate with spring and grub screw

•

•

1

MANIGLIA CON ROSETTA / LEVER HANDLE ON ROSE

226 MR 006 Maniglia con rosetta 006 mm Ø50x8 tipo lusso con molla e grano
Lever Handle on rose lusso type with spring and grub screw

•

•

1

226 MR 009 Maniglia con rosetta 009 mm 62x32 ovale con molla e grano
Lever Handle on rose oval with spring and grub screw

•

•

1



226 MR 416 Maniglia con rosetta 416 mm Ø50x8 con molla e grano
Lever Handle on rose with spring and grub screw

•

•

1

CREMONESE / WINDOW HANDLE WITH MECHANISM

226 SG 070* Cremonese con placca 070 mm 189x36 coprivite con gioco
Window Handle on plate with cover-screw plate with mechanism

•

•

2

MARTELLINA / WINDOW HANDLE WITHOUT MECHANISM

226 SE 070* Martellina con placca 070 mm 189x36 coprivite q.7
Window Handle on plate with cover-screw plate with square-pin mm. 7

•

•

2

DREH KIPP / DREH KIPP

226 DK 015 Dreh Kipp con rosetta 015 mm 65x31 con movimento in metallo
Dreh Kipp on rose with metal mechanism

•

•

2

* Placca adatta a movimenti intercambiabili
Plate suitable to interchangeable movements

Per caratteristiche tecniche rosette vedi apposito capitolo soluzioni tecniche e componenti / For technical specifications rosettes see specific section technical solutions and components

A RICHIESTA / ON REQUEST:

- Mezza maniglia con placca o con rosetta (specificare se destra o sinistra) / Half lever handle on plate or on rose (to specify if right or left)
- Maniglia con rosette senza bocchette / Lever handle on rose without rose for key
- Coppie impugnature (CM) con grano e ferro senza rosette e senza bocchette / Pair levers (CM) with grub screws and square pin without rose and without rose for key

art. 228 TRIS

design: Studio Reguitti
materiale: Ottone
material: Solid Brass

Brass Class
100% Ottone



228 MR 005 OS/LV



228 MR 416 OS/LV



228 MR 416 OSC/OC



228 MP 130 OSC/OC



228 MR Q86 OSC/OC



228 DK 015 OSC/OC

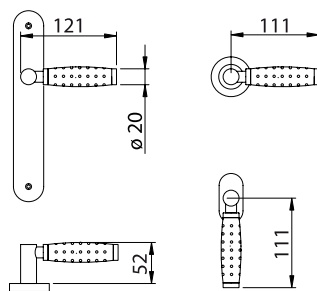

VERSIONI / VERSIONS



Finiture
Finishes

MANIGLIA CON PLACCA / LEVER HANDLE ON PLATE

					OS/LV	OSC/OC	
228 MP 188	Maniglia con placca Lever Handle on plate	188 mm 255x42	con molla e grano with spring and grub screw		•	•	1
228 MP 210	Maniglia con placca Lever Handle on plate	210 mm 210x54	con molla e grano with spring and grub screw		•	•	1
228 MP 130	Maniglia con placca Lever Handle on plate	130 mm 245x50	con molla e grano with spring and grub screw		•	•	1

MANIGLIA CON ROSETTA / LEVER HANDLE ON ROSE



228 MR 004	Maniglia con rosetta Lever Handle on rose	004 mm Ø45x9	con molla e grano with spring and grub screw		•	•	1
228 MR 005	Maniglia con rosetta Lever Handle on rose	005 mm Ø50x8	tipo lusso con molla e grano lusso type with spring and grub screw		•	•	1
228 MR 009	Maniglia con rosetta Lever Handle on rose	009 mm 62x32	ovale con molla e grano oval with spring and grub screw		•	•	1
228 MR 416	Maniglia con rosetta Lever Handle on rose	416 mm Ø45x9	con molla e grano with spring and grub screw		•	•	1
228 MR 816	Maniglia con rosetta Lever Handle on rose	816 mm Ø50x10	con molla e grano with spring and grub screw		•	•	1
228 MR Q86	Maniglia con rosetta Lever Handle on rose	Q86 mm 50x50	con molla e grano with spring and grub screw		•	•	1

CREMONESE / WINDOW HANDLE WITH MECHANISM

228 SG 070*	Cremonese con placca Window Handle on plate	070 mm 189x36	coprivite con gioco with cover-screw plate with mechanism		•	•	2
-------------	--	---------------	--	--	---	---	---

MARTELLINA / WINDOW HANDLE WITHOUT MECHANISM

228 SE 070*	Martellina con placca Window Handle on plate	070 mm 189x36	coprivite q.7 with cover-screw plate with square-pin mm 7		•	•	2
-------------	---	---------------	--	--	---	---	---

DREH KIPP / DREH KIPP

228 DK 015	Dreh Kipp con rosetta Dreh Kipp on rose	015 mm 65x31	con movimento in metallo with metal mechanism		•	•	3
------------	--	--------------	--	--	---	---	---

*Placca adatta a movimenti intercambiabili - Plate suitable to interchangeable movements

A RICHIESTA / ON REQUEST:

- Mezza maniglia con placca o con rosetta (specificare se destra o sinistra) / Half lever handle on plate or on rose (to specify if right or left)
- Maniglia con rosette senza bocchette / Lever handle on rose without rose for key
- Coppie impugnature (CM) con grano e ferro senza rosette e senza bocchette / Pair levers (CM) with grub screws and square pin without rose and without rose for key

art. 229 STYLUS

design: Studio Reguitti
materiale: Ottone
material: Solid Brass

Brass Class
100% Ottone

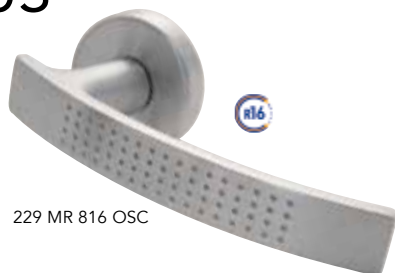

229 MR 816 OSC

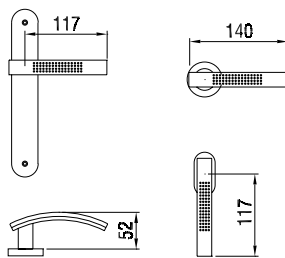

229 MR Q86 OSC



229 MR 816 OS



229 MP 130 OSC



229 DK 015 OSC



229 DK Q15 OSC

VERSIONI / VERSIONS



Finishes
Finishes

LV
OS

OC
OSC



MANIGLIA CON PLACCA / LEVER HANDLE ON PLATE

	229 MP 130	Maniglia con placca Lever Handle on plate	130 mm 245x50	con molla e grano with spring and grub screw	•	•	3
--	------------	--	---------------	---	---	---	---

MANIGLIA CON ROSETTA / LEVER HANDLE ON ROSE

	229 MR 416	Maniglia con rosetta Lever Handle on rose	416 mm Ø45x9	con molla e grano with spring and grub screw	•	•	1
	229 MR 816	Maniglia con rosetta Lever Handle on rose	816 mm Ø50x10	con molla e grano with spring and grub screw	•	•	1
	229 MR Q86	Maniglia con rosetta Lever Handle on rose	Q86 mm 50x50	con molla e grano with spring and grub screw	•	•	1

CREMONESE / WINDOW HANDLE WITH MECHANISM

	229 SG 070*	Martellina con placca Window Handle on plate	070 mm 189x36	coprivate con gioco with cover-screw plate with mechanism	•	•	2
	229 SG Q13*	Martellina con placca Window Handle on plate	Q13 mm 160x33	coprivate con gioco with cover-screw plate with mechanism	•	•	2

MARTELLINA / WINDOW HANDLE WITHOUT MECHANISM

	229 SE 070*	Martellina con placca Window Handle on plate	070 mm 189x36	coprivate q.7 with cover-screw plate with square-pin mm 7	•	•	2
	229 SE Q13*	Martellina con placca Window Handle on plate	Q13 mm 160x33	coprivate q.7 with cover-screw plate with square-pin mm 7	•	•	2

DREH KIPP / DREH KIPP

	229 DK 015	Dreh Kipp con rosetta Dreh Kipp on rose	015 mm 65x31	con movimento in metallo with metal mechanism	•	•	3
	229 DK Q15	Dreh Kipp con rosetta Dreh Kipp on rose	Q15 mm 65x31	con movimento in metallo with metal mechanism	•	•	3

* Placca adatta a movimenti intercambiabili - Plate suitable to interchangeable movements

A RICHIESTA / ON REQUEST:

- Mezza maniglia con placca o con rosetta (specificare se destra o sinistra) / Half lever handle on plate or on rose (to specify if right or left)
- Maniglia con rosette senza bocchette / Lever handle on rose without rose for key
- Coppie impugnature (CM) con grano e ferro senza rosette e senza bocchette / Pair levers (CM) with grub screws and square pin without rose and without rose for key

art. 230 ISOLDE

design: Studio Reguitti
materiale: Ottone / Legno
material: Solid Brass - Wood

Brass Class
100% Ottone



230 MR 006 CLG/OSC

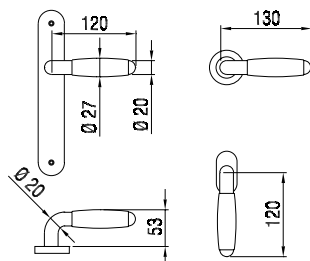

230 MR 416 SC/OSC



230 MR 006 SC/LV



230 MR 006 CLG/OC



230 MP 188 CLG/OSC



230 SE 070 CLG/OSC
230 SG 070 CLG/OSC



230 DK 015 CLG/OSC

VERSIONI / VERSIONS



Finiture
Finishes

						CLG/LV SC/LV	CLG/OC SC/OC	CLG/OSC SC/OSC	
MANIGLIA CON PLACCA / LEVER HANDLE ON PLATE									
	230 MP 188	Maniglia con placca Lever Handle on plate	188 mm 255x42	con molla e grano with spring and grub screw		•	•	•	1
	230 MP 248	Maniglia con placca Lever Handle on plate	248 mm 248x50	con molla e grano with spring and grub screw		•	•	•	1
MANIGLIA CON ROSETTA / LEVER HANDLE ON ROSE									
	230 MR 006	Maniglia con rosetta Lever Handle on rose	006 mm Ø50x8	tipo lusso con molla e grano luxu type with spring and grub screw		•	•	•	1
	230 MR 416	Maniglia con rosetta Lever Handle on rose	416 mm Ø45x9	con molla e grano with spring and grub screw		•	•	•	1
CREMONESE / WINDOW HANDLE WITH MECHANISM									
	230 SG 070*	Cremonese con placca Window Handle on plate	070 mm 189x36	coprivite con gioco with cover-screw plate with mechanism		•	•	•	2
MARTELLINA / WINDOW HANDLE WITHOUT MECHANISM									
	230 SE 070*	Martellina con placca Window Handle on plate	070 mm 189x36	coprivite q.7 with cover-screw plate with square-pin mm 7		•	•	•	2
DREH KIPP / DREH KIPP									
	230 DK 015	Dreh Kipp con rosetta Dreh Kipp on rose	015 mm 65x31	con movimento in metallo with metal mechanism		•	•	•	3

* Placca adatta a movimenti intercambiabili - Plate suitable to interchangeable movements

A RICHIESTA / ON REQUEST:

- Mezza maniglia con placca o con rosetta (specificare se destra o sinistra) / Half lever handle on plate or on rose (to specify if right or left)
- Maniglia con rosette senza bocchette / Lever handle on rose without rose for key
- Coppie impugnature (CM) con grano e ferro senza rosette e senza bocchette / Pair levers (CM) with grub screws and square pin without rose and without rose for key

art. 232 HEIDI

design: Studio Reguitti
materiale: Ottone
material: Solid Brass

Brass Class
100% Ottone



232 MR 006 OS/LV

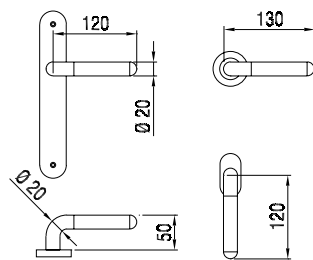

232 MR 416 OSC/OC



232 MR 006 OSC/OC



232 MR 006 NR/OC



232 MP 188 OS/LV



232 DK 015 OS/LV
232 DK 024 OS/LV



232 DK C67 OS/LV



232 SE 070 OS/LV
232 SG 070 OS/LV

VERSIONI / VERSIONS



MANIGLIA CON PLACCA / LEVER HANDLE ON PLATE



232 MP 188 Maniglia con placca 188 mm 255x42 con molla e grano
Lever Handle on plate with spring and grub screw

OS/LV	NR/OSC NR/OC	OC/LV OSC/OC	INOX SAT/OC	
•	•	•	•	1

MANIGLIA CON ROSETTA / LEVER HANDLE ON ROSE

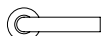

232 MR 004 Maniglia con rosetta 004 mm Ø45x9 con molla e grano
Lever Handle on rose with spring and grub screw

•	•	•	•	2
---	---	---	---	---



232 MR 006 Maniglia con rosetta 006 mm Ø50x8 tipo lusso con molla e grano
Lever Handle on rose lusso type with spring and grub screw

•	•	•	•	2
---	---	---	---	---



232 MR 416 Maniglia con rosetta 416 mm Ø45x9 con molla e grano
Lever Handle on rose with spring and grub screw

•	•	•	•	1
---	---	---	---	---

CREMONESE / WINDOW HANDLE WITH MECHANISM



232 SG 070* Cremonese con placca 070 mm 189x36 coprivite con gioco
Window Handle on plate with cover-screw plate with mechanism

•	•	•	•	2
---	---	---	---	---

MARTELLINA / WINDOW HANDLE WITHOUT MECHANISM



232 SE 070* Martellina con placca 070 mm 189x36 coprivite q.7
Window Handle on plate with cover-screw plate with square-pin mm 7

•	•	•	•	2
---	---	---	---	---

DREH KIPP / DREH KIPP



232 DK 015 Dreh Kipp con rosetta 015 mm 65x31 con movimento in metallo
Dreh Kipp on rose with metal mechanism

•	•	•	•	3
---	---	---	---	---

232 DK 024 Dreh Kipp con rosetta 024 mm 65x31 c/mov. in metallo e quadro autoregolante
Dreh Kipp on rose with metal mec. and adjustable square-pin

•	•	•	•	3
---	---	---	---	---



232 DK 075 Dreh Kipp con rosetta 075 mm 64x30 con mov. securblock e pulsante di sicurezza
Safety DK on rose with securblock system and push button

•	•	•	•	2
---	---	---	---	---

232 DK C67 Dreh Kipp con rosetta C67 mm 69x33 c/ chiave e cilindro e movimento in metallo
Safety DK on rose with key and cylinder and metal mechanism

•	•	•	•	1
---	---	---	---	---

* Placca adatta a movimenti intercambiabili - Plate suitable to interchangeable movements

A RICHIESTA / ON REQUEST:

- Mezza maniglia con placca o con rosetta (specificare se destra o sinistra) / Half lever handle on plate or on rose (to specify if right or left)
- Maniglia con rosette senza bocchette / Lever handle on rose without rose for key
- Coppie impugnature (CM) con grano e ferro senza rosette e senza bocchette / Pair levers (CM) with grub screws and square pin without rose and without rose for key

art. 233 JESSICA

design: Studio Reguitti
materiale: Ottone - Legno
material: Solid Brass - Wood

Brass Class
100% Ottone



233 MR 005 SC/OC

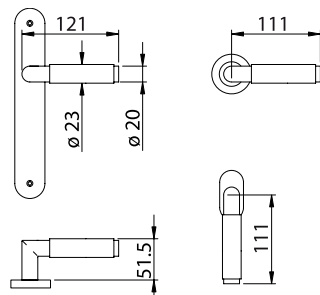

233 MR 005 FG/OSC



233 MR 005 SC/OSC



233 MR 005 SC/LV



233 MR 005 CLG/OC



233 MR 005 CLG/OSC



233 MR 005 CLG/LV



233 MP 188 SC/LV



233 SE 070 SC/LV
233 SG 070 SC/LV











233 DK 015 SC/LV

VERSIONI / VERSIONS



Finiture
Finishes

MANIGLIA CON PLACCA / LEVER HANDLE ON PLATE				FG/LV CLG/LV SC/LV	FG/OC CLG/OC SC/OC	FG/OSC CLG/OSC SC/OSC	
	233 MP 188	Maniglia con placca Lever Handle on plate	188 mm 255x42 con molla e grano with spring and grub screw	•	•	•	1
MANIGLIA CON ROSETTA / LEVER HANDLE ON ROSE							
	233 MR 005	Maniglia con rosetta Lever Handle on rose	005 mm Ø50x8 tipo lusso con molla e grano lusso type with spring and grub screw	•	•	•	1
	233 MR 416	Maniglia con rosetta Lever Handle on rose	416 mm Ø45x9 con molla e grano with spring and grub screw	•	•	•	1
	233 MR Q86	Maniglia con rosetta Lever Handle on rose	Q86 mm 50x50 con molla e grano with spring and grub screw	•	•	•	1
CREMONESE / WINDOW HANDLE WITH MECHANISM							
	233 SG 070*	Cremonese con placca Window Handle on plate	070 mm 189x36 coprivite con gioco with cover-screw plate with mechanism	•	•	•	2
MARTELLINA / WINDOW HANDLE WITHOUT MECHANISM							
	233 SE 070*	Martellina con placca Window Handle on plate	070 mm 189x36 coprivite q.7 with cover-screw plate with square-pin mm 7	•	•	•	2
DREH KIPP / DREH KIPP							
	233 DK 015	Dreh Kipp con rosetta Dreh Kipp on rose	015 mm 65x31 con movimento in metallo with metal mechanism	•	•	•	3

* Placca adatta a movimenti intercambiabili - Plate suitable to interchangeable movements

Per caratteristiche tecniche rosette vedi apposito capitolo soluzioni tecniche e componenti / For technical specifications rosettes see specific section technical solutions and components

A RICHIESTA / ON REQUEST:

- Mezza maniglia con placca o con rosetta (specificare se destra o sinistra) / Half lever handle on plate or on rose (to specify if right or left)
- Maniglia con rosette senza bocchette / Lever handle on rose without rose for key
- Coppie impugnature (CM) con grano e ferro senza rosette e senza bocchette / Pair levers (CM) with grub screws and square pin without rose and without rose for key

art. 234 ALEXIS

design: Studio Reguitti
materiale: Ottone/Acciaio
material: Solid Brass - Stainless Steel

Brass Class
100% Ottone



234 MR 005 INOX SAT/OC

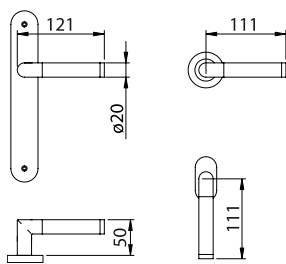

234 MR 005 NR/OC



234 MR 005 OS/LV



234 MR 005 OSC/OC



234 MP 188 OS/LV



234 SE 070 OS/LV
234 SG 070 OS/LV







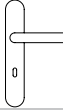

234 DK 015 OS/LV

VERSIONI / VERSIONS



Finiture
Finishes

					OS/LV	NR/OC OC/LV OSC/OC	INOX SAT/OC	
MANIGLIA CON PLACCA / LEVER HANDLE ON PLATE								
	234 MP 188	Maniglia con placca Lever Handle on plate	188 mm 255x42	con molla e grano with spring and grub screw	•	•	•	1
	234 MP 130	Maniglia con placca Lever Handle on plate	130 mm 245x50	con molla e grano with spring and grub screw	•	•	•	1
MANIGLIA CON ROSETTA / LEVER HANDLE ON ROSE								
	234 MR 005	Maniglia con rosetta Lever Handle on rose	005 mm Ø50x8	tipo lusso con molla e grano lusso type with spring and grub screw	•	•	•	2
	234 MR 416	Maniglia con rosetta Lever Handle on rose	416 mm Ø45x9	con molla e grano with spring and grub screw	•	•	•	1
	234 MR Q86	Maniglia con rosetta Lever Handle on rose	Q86 mm 50x50	con molla e grano with spring and grub screw	•	•	•	1
CREMONESE / WINDOW HANDLE WITH MECHANISM								
	234 SG 070*	Cremonese con placca Window Handle on plate	070 mm 189x36	coprivite con gioco with cover-screw plate with mechanism	•	•	•	2
MARTELLINA / WINDOW HANDLE WITHOUT MECHANISM								
	234 SE 070*	Martellina con placca Window Handle on plate	070 mm 189x36	coprivite q.7 with cover-screw plate with square-pin mm 7	•	•	•	2
DREH KIPP / DREH KIPP								
	234 DK 015	Dreh Kipp con rosetta Dreh Kipp on rose	015 mm 65x31	con movimento in metallo with metal mechanism	•	•	•	3

* Placca adatta a movimenti intercambiabili
Plate suitable to interchangeable movements

A RICHIESTA / ON REQUEST:

- Mezza maniglia con placca o con rosetta (specificare se destra o sinistra) / Half lever handle on plate or on rose (to specify if right or left)
- Maniglia con rosette senza bocchette / Lever handle on rose without rose for key
- Coppie impugnature (CM) con grano e ferro senza rosette e senza bocchette / Pair levers (CM) with grub screws and square pin without rose and without rose for key

art. 236 VILMA

design: Studio Reguitti
materiale: Ottone/Alluminio
material: Solid Brass - Aluminium

Brass Class
100% Ottone



236 MR 005 AA/OC

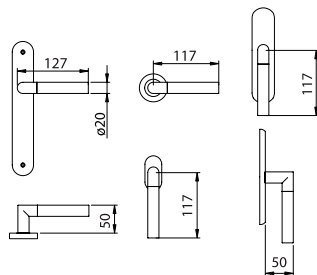

236 MR 816 AA/OC



236 MR 416 AA/OC



236 DK 015 AA/OC

VERSIONI / VERSIONS



Finiture
Finishes

AA/OC



MANIGLIA CON PLACCA / LEVER HANDLE ON PLATE

	236 MP 188	Maniglia con placca Lever Handle on plate	188 mm 255x42	con molla e grano with spring and grub screw	•	1
--	------------	--	---------------	---	---	---

MANIGLIA CON ROSETTA / LEVER HANDLE ON ROSE

	236 MR 005	Maniglia con rosetta Lever Handle on rose	005 mm Ø50x8	tipo lusso con molla e grano lusso type with spring and grub screw	•	1
	236 MR 416	Maniglia con rosetta Lever Handle on rose	416 mm Ø45x9	con molla e grano with spring and grub screw	•	1
	236 MR 816	Maniglia con rosetta Lever Handle on rose	816 mm Ø50x10	con molla e grano with spring and grub screw	•	1

CREMONESE / WINDOW HANDLE WITH MECHANISM

	236 SG 070*	Cremonese con placca Window Handle on plate	070 mm 189x36	coprivite con gioco with cover-screw plate with mechanism	•	2
--	-------------	--	---------------	--	---	---

MARTELLINA / WINDOW HANDLE WITHOUT MECHANISM

	236 SE 070*	Martellina con placca Window Handle on plate	070 mm 189x36	coprivite q.7 with cover-screw plate with square-pin mm 7	•	2
--	-------------	---	---------------	--	---	---

DREH KIPP / DREH KIPP

	236 DK 015	Dreh Kipp con rosetta Dreh Kipp on rose	015 mm 65x31	con movimento in metallo with metal mechanism	•	3
--	------------	--	--------------	--	---	---

* Placca adatta a movimenti intercambiabili
Plate suitable to interchangeable movements

A RICHIESTA / ON REQUEST:

- Mezza maniglia con placca o con rosetta (specificare se destra o sinistra) / Half lever handle on plate or on rose (to specify if right or left)
- Maniglia con rosette senza bocchette / Lever handle on rose without rose for key
- Coppie impugnature (CM) con grano e ferro senza rosette e senza bocchette / Pair levers (CM) with grub screws and square pin without rose and without rose for key

art. 237 LIRA

design: Marco Pialorsi
materiale: Ottone
material: Solid Brass

Brass Class
100% Ottone



237 MR 006 OC

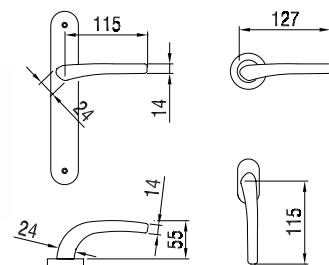

237 MR 009 LV



237 MR 416 BG



237 MR 816 OSC



237 MP 188 LV



237 SE 070 LV
237 SG 070 LV

destra/right

destra/right

destra/right



237 DK C67 LV



237 DK 015 LV

VERSIONI / VERSIONS



MANIGLIA CON PLACCA / LEVER HANDLE ON PLATE				LV	BG	OS	OSC	OC	
	237 MP 188	Maniglia con placca Lever Handle on plate	188 mm 255x42 con molla e grano with spring and grub screw	•			•		1
MANIGLIA CON ROSETTA / LEVER HANDLE ON ROSE									
	237 MR 006	Maniglia con rosetta Lever Handle on rose	006 mm Ø50x8 tipo lusso con molla e grano lusso type with spring and grub screw	•			•		1
	237 MR 008	Maniglia con rosetta Lever Handle on rose	008 mm Ø50x8 con molla e grano with spring and grub screw	•			•		2
	237 MR 009	Maniglia con rosetta Lever Handle on rose	009 mm 62x32 ovale con molla e grano oval with spring and grub screw	•			•		1
	237 MR 416	Maniglia con rosetta Lever Handle on rose	416 mm Ø45x9 con molla e grano with spring and grub screw	•			•		1
	237 MR 816	Maniglia con rosetta Lever Handle on rose	816 mm Ø50x10 con molla e grano with spring and grub screw	•			•		1
CREMONESE / WINDOW HANDLE WITH MECHANISM									
	237 SG 137	Cremonese con placca Window Handle on plate	137 mm 167x40 con fori viti con gioco with holes for screws with mechanism	•			•		2
	237 SG 070*	Cremonese con placca Window Handle on plate	070 mm 189x36 coprivite con gioco with cover-screw plate with mechanism	•			•		2
MARTELLINA / WINDOW HANDLE WITHOUT MECHANISM									
	237 SE 137	Martellina con placca Window Handle on plate	137 mm 167x40 con fori viti q.7 with holes for screws with square-pin mm 7	•			•		2
	237 SE 070*	Martellina con placca Window Handle on plate	070 mm 189x36 coprivite q.7 with cover-screw plate with square-pin mm 7	•			•		2
DREH KIPP / DREH KIPP									
	237 DK 015	Dreh Kipp destro con rosetta Dreh Kipp (right) on rose	015 mm 65x31 con movimento in metallo with metal mechanism	•			•		3
	237 DK C67	Dreh Kipp con rosetta Safety DK on rose	C67 mm 69x33 c/ chiave e cilindro e movimento in metallo with key and cylinder and metal mechanism	•			•		1

A RICHIESTA / ON REQUEST:

- Mezza maniglia con placca o con rosetta (specificare se destra o sinistra) / Half lever handle on plate or on rose (to specify if right or left)
- Maniglia con rosette senza bocchette / Lever handle on rose without rose for key
- Coppie impugnature (CM) con grano e ferro senza rosette e senza bocchette / Pair levers (CM) with grub screws and square pin without rose and without rose for key

art. 238 CLARA

design: Studio Reguitti
materiale: Ottone/Alluminio
material: Solid Brass - Aluminium

Brass Class
100% Ottone



238 MR 006 AA/OC



238 MR 816 AA/OC



238 MR 416 AA/OC

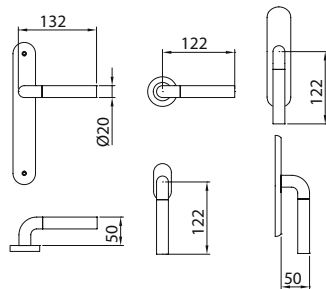

238 DK 015 AA/OC

VERSIONI / VERSIONS



Finishes
Finishes

AA/OC



MANIGLIA CON PLACCA / LEVER HANDLE ON PLATE

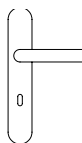

238 MP 188 Maniglia con placca 188 mm 255x42 con molla e grano
Lever Handle on plate with spring and grub screw

• 1

MANIGLIA CON ROSETTA / LEVER HANDLE ON ROSE



238 MR 006 Maniglia con rosetta 006 mm Ø50x8 tipo lusso con molla e grano
Lever Handle on rose lusso type with spring and grub screw

• 1



238 MR 416 Maniglia con rosetta 416 mm Ø45x9 con molla e grano
Lever Handle on rose with spring and grub screw

• 1



238 MR 816 Maniglia con rosetta 816 mm Ø50x10 con molla e grano
Lever Handle on rose with spring and grub screw

• 1

CREMONESE / WINDOW HANDLE WITH MECHANISM



238 SG 070* Cremonese con placca 070 mm 189x36 coprivite con gioco
Window Handle on plate with cover-screw plate with mechanism

• 2

MARTELLINA / WINDOW HANDLE WITHOUT MECHANISM



238 SE 070* Martellina con placca 070 mm 189x36 coprivite q.7
Window Handle on plate with cover-screw plate with square-pin mm 7

• 2

DREH KIPP / DREH KIPP



238 DK 015 Dreh Kipp con rosetta 015 mm 65x31 con movimento in metallo
Dreh Kipp on rose with metal mechanism

• 3

* Placca adatta a movimenti intercambiabili
Plate suitable to interchangeable movements

A RICHIESTA / ON REQUEST:

- Mezza maniglia con placca o con rosetta (specificare se destra o sinistra) / Half lever handle on plate or on rose (to specify if right or left)
- Maniglia con rosette senza bocchette / Lever handle on rose without rose for key
- Coppie impugnature (CM) con grano e ferro senza rosette e senza bocchette / Pair levers (CM) with grub screws and square pin without rose and without rose for key

art. 250 XL.L-PLUS

design: Studio Reguitti
 materiale: Ottone/Acciaio
 material: Solid Brass/Stainless steel

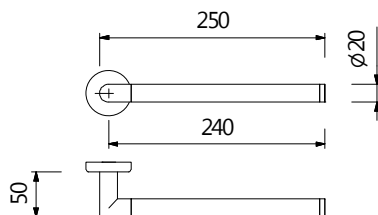

250 MR 005 - INOX SAT/OC

VERSIONI / VERSIONS



Finiture
Finishes

INOX SAT/OC



MANIGLIA CON ROSETTA / LEVER HANDLE ON ROSE

				€	
	250 MR 005	Maniglia con rosetta Lever handle on rose	005 mm Ø50x8	tipo lusso con molla lusso type with spring	• 1
	250 MR 816	Maniglia con rosetta Lever handle on rose	816 mm Ø50x10	con molla with spring	• 1
	250 MR Q86	Maniglia con rosetta Lever handle on rose	Q86 mm 50x50	con molla with spring	• 1

art. 251 GIADA

design: Studio Reguitti
materiale: Ottone
material: Solid Brass

Brass Class
100% Ottone



251 MR 816 OS/LV



251 MR 416 OSC/OC



251 MR 006 OS/LV



251 MR Q86 OSC/OC



251 MR 006 OSC/OC



251 MP 188 OSC/OC



251 SE 070 OSC/OC
251 SG 070 OSC/OC



251 DK 015 OSC/OC

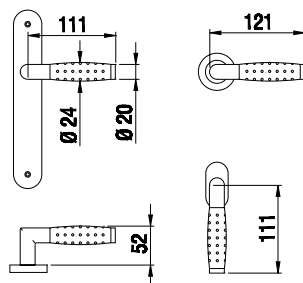

VERSIONI / VERSIONS



Finiture
Finishes

MANIGLIA CON PLACCA / LEVER HANDLE ON PLATE

					OS/LV	OSC/OC	
	251 MP 188	Maniglia con placca Lever Handle on plate	188 mm 255x42	con molla e grano with spring and grub screw	•	•	1
	251 MP 130	Maniglia con placca Lever Handle on plate	130 mm 245x50	con molla e grano with spring and grub screw	•	•	1

MANIGLIA CON ROSETTA / LEVER HANDLE ON ROSE

	251 MR 006	Maniglia con rosetta Lever Handle on rose	006 mm Ø50x8	tipo lusso con molla e grano lusso type with spring and grub screw	•	•	1
	251 MR 009	Maniglia con rosetta Lever Handle on rose	009 mm 62x32	ovale con molla e grano oval with spring and grub screw	•	•	1
	251 MR 416	Maniglia con rosetta Lever Handle on rose	416 mm Ø45x9	con molla e grano with spring and grub screw	•	•	1
	251 MR 816	Maniglia con rosetta Lever Handle on rose	816 mm Ø50x10	con molla e grano with spring and grub screw	•	•	1
	251 MR Q86	Maniglia con rosetta Lever Handle on rose	Q86 mm 50x50	con molla e grano with spring and grub screw	•	•	1

CREMONESE / WINDOW HANDLE WITH MECHANISM

	251 SG 070*	Cremonese con placca Window Handle on plate	070 mm 189x36	coprivite con gioco with cover-screw plate with mechanism	•	•	2
--	-------------	--	---------------	--	---	---	---

MARTELLINA / WINDOW HANDLE WITHOUT MECHANISM

	251 SE 070*	Martellina con placca Window Handle on plate	070 mm 189x36	coprivite q.7 with cover-screw plate with square-pin mm. 7	•	•	2
--	-------------	---	---------------	---	---	---	---

DREH KIPP / DREH KIPP

	251 DK 015	Dreh Kipp con rosetta Dreh Kipp on rose	015 mm 65x31	con movimento in metallo with metal mechanism	•	•	3
--	------------	--	--------------	--	---	---	---

* Placca adatta a movimenti intercambiabili
Plate suitable to interchangeable movements

A RICHIESTA / ON REQUEST:

- Mezza maniglia con placca o con rosetta (specificare se destra o sinistra) / Half lever handle on plate or on rose (to specify if right or left)
- Maniglia con rosette senza bocchette / Lever handle on rose without rose for key
- Coppie impugnature (CM) con grano e ferro senza rosette e senza bocchette / Pair levers (CM) with grub screws and square pin without rose and without rose for key

art. 252 AMBRA

design: Studio Reguitti
materiale: Ottone
material: Solid Brass

Brass Class
100% Ottone



252 MP 248 OSC/OC

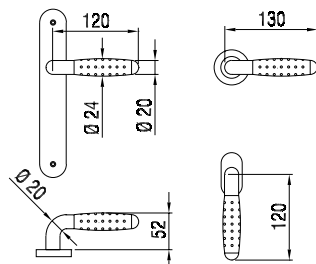

252 MR 816 OSC/OC



252 MR 416 OS/LV



252 MR 006 OS/LV



252 MR 006 OSC/OC



252 MP 188 OS/LV



252 DK 015 OS/LV



252 DK C67 OS/LV







252 SE 070 OS/LV
252 SG 070 OS/LV

VERSIONI / VERSIONS



Finire
Finishes

				OS/LV	OSC/OC		
MANIGLIA CON PLACCA / LEVER HANDLE ON PLATE							
	252 MP 188	Maniglia con placca Lever Handle on plate	188 mm 255x42	con molla e grano with spring and grub screw	•	•	1
	252 MP 248	Maniglia con placca Lever Handle on plate	248 mm 248x50	con molla e grano with spring and grub screw	•	•	1
MANIGLIA CON ROSETTA / LEVER HANDLE ON ROSE							
	252 MR 006	Maniglia con rosetta Lever Handle on rose	006 mm Ø50x8	tipo lusso con molla e grano luxury type with spring and grub screw	•	•	1
	252 MR 009	Maniglia con rosetta Lever Handle on rose	009 mm 62x32	ovale con molla e grano oval with spring and grub screw	•	•	1
	252 MR 416	Maniglia con rosetta Lever Handle on rose	416 mm Ø45x9	con molla e grano with spring and grub screw	•	•	1
	252 MR 816	Maniglia con rosetta Lever Handle on rose	816 mm Ø50x10	con molla e grano with spring and grub screw	•	•	1
CREMONESE / WINDOW HANDLE WITH MECHANISM							
	252 SG 070*	Cremonese con placca Window Handle on plate	070 mm 189x36	coprivite con gioco with cover-screw plate with mechanism	•	•	2
MARTELLINA / WINDOW HANDLE WITHOUT MECHANISM							
	252 SE 070*	Martellina con placca Window Handle on plate	070 mm 189x36	coprivite q.7 with cover-screw plate with square-pin mm 7	•	•	2
DREH KIPP / DREH KIPP							
	252 DK 015	Dreh Kipp con rosetta Dreh Kipp on rose	015 mm 65x31	con movimento in metallo with metal mechanism	•	•	3
	252 DK C67	Dreh Kipp con rosetta Safety DK on rose	C67 mm 69x33	c/ chiave e cilindro e movimento in metallo with key and cylinder and metal mechanism	•	•	1

A RICHIESTA / ON REQUEST:

- Mezza maniglia con placca o con rosetta (specificare se destra o sinistra) / Half lever handle on plate or on rose (to specify if right or left)
- Maniglia con rosetta senza bocchette / Lever handle on rose without rose for key
- Coppie impugnature (CM) con grano e ferro senza rosette e senza bocchette / Pair levers (CM) with grub screws and square pin without rose and without rose for key

art.271 CIGNO

design: Marco Pialorsi
materiale: Ottone
material: Solid Brass

Brass Class
100% Ottone

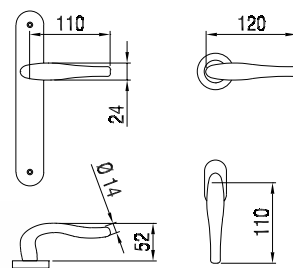

271 MR 008 OC



271 MR 416 BG



271 MR 004 OSC



271 MR 006 LV



271 DK 015 LV
271 DK 024 LV

VERSIONI / VERSIONS



Finiture
Finishes

MANIGLIA CON PLACCA / LEVER HANDLE ON PLATE					OS LV BG	OSC OC	
	271 MP 188	Maniglia con placca Lever Handle on plate	188 mm 255x42	con molla e grano with spring and grub screw	•	•	1
	271 MP 248	Maniglia con placca Lever Handle on plate	248 mm 248x50	con molla e grano with spring and grub screw	•	•	1
MANIGLIA CON ROSETTA / LEVER HANDLE ON ROSE							
	271 MR 004	Maniglia con rosetta Lever Handle on rose	004 mm Ø45x9	con molla e grano with spring and grub screw	•	•	2
	271 MR 006	Maniglia con rosetta Lever Handle on rose	006 mm Ø50x8	tipo lusso con molla e grano luxury type with spring and grub screw	•	•	1
	271 MR 008	Maniglia con rosetta Lever Handle on rose	008 mm Ø50x8	con molla e grano with spring and grub screw	•	•	1
	271 MR 009	Maniglia con rosetta Lever Handle on rose	009 mm 62x32	ovale con molla e grano oval with spring and grub screw	•	•	1
	271 MR 416	Maniglia con rosetta Lever Handle on rose	416 mm Ø45x9	con molla e grano with spring and grub screw	•	•	1
	271 MR 816	Maniglia con rosetta Lever Handle on rose	816 mm Ø50x10	con molla e grano with spring and grub screw	•	•	1
DREH KIPP / DREH KIPP							
	271 DK 015	Dreh Kipp con rosetta Dreh Kipp on rose	015 mm 65x31	con movimento in metallo with metal mechanism	•	•	3
	271 DK 024	Dreh Kipp con rosetta Dreh Kipp on rose	024 mm 65x31	c/mov. in metallo e quadro autoregolante with metal mec. and adjustable square-pin	•	•	3

* Placca adatta a movimenti intercambiabili
Plate suitable to interchangeable movements

Per caratteristiche tecniche rosette vedi apposito capitolo soluzioni tecniche e componenti / For technical specifications rosettes see specific section technical solutions and components

A RICHIESTA / ON REQUEST:

- Mezza maniglia con placca o con rosetta (specificare se destra o sinistra) / Half lever handle on plate or on rose (to specify if right or left)
- Maniglia con rosette senza bocchette / Lever handle on rose without rose for key
- Coppie impugnature (CM) con grano e ferro senza rosette e senza bocchette / Pair levers (CM) with grub screws and square pin without rose and without rose for key

art. 272 SOFFIO

design: Studio Reguitti - B&M
 materiale: Ottone
 material: Solid Brass

Brass Class
 100% Ottone

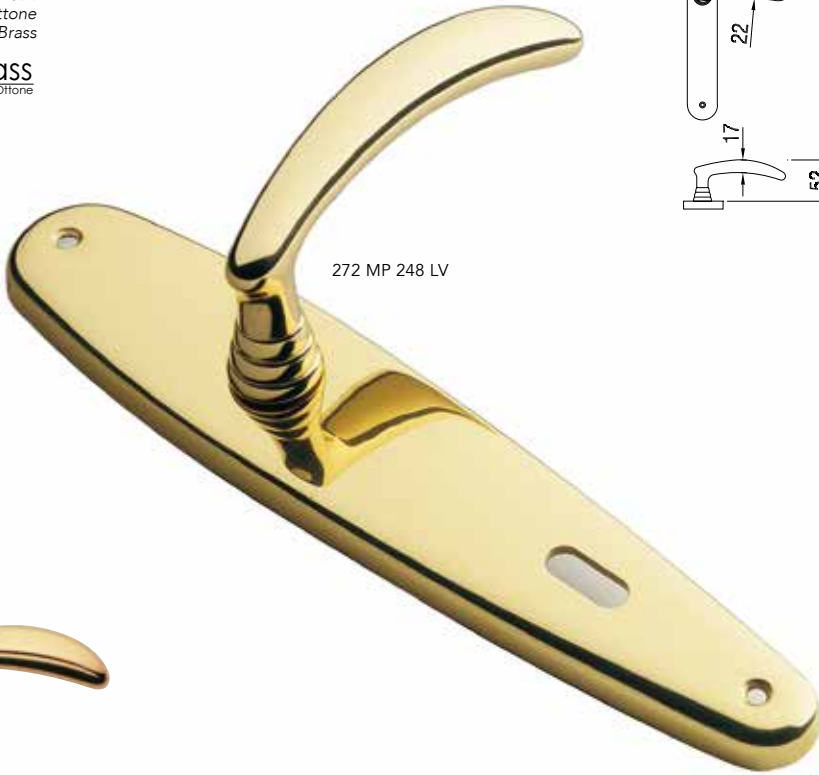
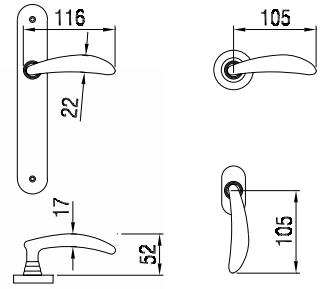

272 MR 009 LV



272 MR 006 OC



272 MR 416 OSC



272 MR 004 BG



272 MR 006 OS



272 MR 006 LV



272 MP 188 LV

destra/right



272 SE 070 LV
 272 SG 070 LV

destra/right



272 DK 015 LV



						LV BG OS	OSC OC	
MANIGLIA CON PLACCA / LEVER HANDLE ON PLATE								
	272 MP 188	Maniglia con placca Lever Handle on plate	188	mm 255x42	con molla e grano with spring and grub screw	•	•	1
	272 MP 248	Maniglia con placca Lever Handle on plate	248	mm 248x50	con molla e grano with spring and grub screw	•	•	1
MANIGLIA CON ROSETTA / LEVER HANDLE ON ROSE								
	272 MR 004	Maniglia con rosetta Lever Handle on rose	004	mm Ø45x9	con molla e grano with spring and grub screw	•	•	2
	272 MR 006	Maniglia con rosetta Lever Handle on rose	006	mm Ø50x8	tipo lusso con molla e grano luxu type with spring and grub screw	•	•	1
	272 MR 008	Maniglia con rosetta Lever Handle on rose	008	mm Ø50x8	con molla e grano with spring and grub screw	•	•	1
	272 MR 009	Maniglia con rosetta Lever Handle on rose	009	mm 62x32	ovale con molla e grano oval with spring and grub screw	•	•	1
	272 MR 416	Maniglia con rosetta Lever Handle on rose	416	mm Ø45x9	con molla e grano with spring and grub screw	•	•	1
	272 MR 816	Maniglia con rosetta Lever Handle on rose	816	mm Ø50x10	con molla e grano with spring and grub screw	•	•	1
CREMONESE / WINDOW HANDLE WITH MECHANISM								
	272 SG 137	Cremonese con placca Window Handle on plate	137	mm 167x40	con fori viti con gioco with holes for screws with mechanism	•	•	2
	272 SG 070*	Cremonese con placca Window Handle on plate	070	mm 189x36	coprivate con gioco with cover-screw plate with mechanism	•	•	2
MARTELLINA / WINDOW HANDLE WITHOUT MECHANISM								
	272 SE 137	Martellina con placca Window Handle on plate	137	mm 167x40	con fori viti q.7 with holes for screws with square-pin mm 7	•	•	2
	272 SE 070*	Martellina con placca Window Handle on plate	070	mm 189x36	coprivate q.7 with cover-screw plate with square-pin mm 7	•	•	2
DREH KIPP / DREH KIPP								
	272 DK 015	Dreh Kipp destro con rosetta Dreh Kipp (right) on rose	015	mm 65x31	con movimento in metallo with metal mechanism	•	•	3

* Placca adatta a movimenti intercambiabili
Plate suitable to interchangeable movements



272 MP 248 LV



272 MR 816 OC

Per caratteristiche tecniche rosette vedi apposito capitolo soluzioni tecniche e componenti / For technical specifications rosettes see specific section technical solutions and components

A RICHIESTA / ON REQUEST:

- Mezza maniglia con placca o con rosetta (specificare se destra o sinistra) / Half lever handle on plate or on rose (to specify if right or left)
- Maniglia con rosette senza bocchette / Lever handle on rose without rose for key
- Coppie impugnature (CM) con grano e ferro senza rosette e senza bocchette / Pair levers (CM) with grub screws and square pin without rose and without rose for key

art. 273 TRIANGOLO

design: Marco Pialorsi
 materiale: Ottone
 material: Solid Brass

Brass Class
 100% Ottone

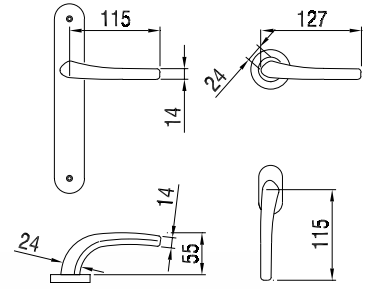

273 MR 006 LV



273 MR 416 BG



273 MR 816 OSC



273 MR 008 OSC



273 MR 006 OC



273 MR 006 LV



273 MP 188 LV

destra/right



273 SE 070 LV
 273 SG 070 LV

destra/right



273 DK 015 LV

VERSIONI / VERSIONS



Finiture
Finishes

					LV BG OS	OSC OC	
MANIGLIA CON PLACCA / LEVER HANDLE ON PLATE							
	273 MP 188	Maniglia con placca Lever Handle on plate	188 mm 255x42	con molla e grano with spring and grub screw	•	•	1
MANIGLIA CON ROSETTA / LEVER HANDLE ON ROSE							
	273 MR 006	Maniglia con rosetta Lever Handle on rose	006 mm Ø50x8	tipo lusso con molla e grano lusso type with spring and grub screw	•	•	1
	273 MR 008	Maniglia con rosetta Lever Handle on rose	008 mm Ø50x8	con molla e grano with spring and grub screw	•	•	2
	273 MR 009	Maniglia con rosetta Lever Handle on rose	009 mm 62x32	ovale con molla e grano oval with spring and grub screw	•	•	1
	273 MR 416	Maniglia con rosetta Lever Handle on rose	416 mm Ø45x9	con molla e grano with spring and grub screw	•	•	1
	273 MR 816	Maniglia con rosetta Lever Handle on rose	816 mm Ø50x10	con molla e grano with spring and grub screw	•	•	1
CREMONESE / WINDOW HANDLE WITH MECHANISM							
	273 SG 137	Cremonese con placca Window Handle on plate	137 mm 167x40	con fori viti con gioco with holes for screws with mechanism	•	•	2
	273 SG 070*	Cremonese con placca Window Handle on plate	070 mm 189x36	coprivite con gioco with cover-screw plate with mechanism	•	•	2
MARTELLINA / WINDOW HANDLE WITHOUT MECHANISM							
	273 SE 137	Martellina con placca Window Handle on plate	137 mm 167x40	con fori viti q.7 with holes for screws with square-pin mm 7	•	•	2
	273 SE 070*	Martellina con placca Window Handle on plate	070 mm 189x36	coprivite q.7 with cover-screw plate with square-pin mm 7	•	•	2
DREH KIPP / DREH KIPP							
	273 DK 015	Dreh Kipp destro con rosetta Dreh Kipp (right) on rose	015 mm 65x31	con movimento in metallo with metal mechanism	•	•	3
	273 DK C67	Dreh Kipp con rosetta Safety DK on rose	C67 mm 69x33	c/ chiave e cilindro e movimento in metallo with key and cylinder and metal mechanism	•	•	1

* Placca adatta a movimenti intercambiabili
Plate suitable to interchangeable movements

destro/right



273 DK C67 LV

Per caratteristiche tecniche rosette vedi apposito capitolo soluzioni tecniche e componenti / For technical specifications rosettes see specific section technical solutions and components

A RICHIESTA / ON REQUEST:

- Mezza maniglia con placca o con rosetta (specificare se destra o sinistra) / Half lever handle on plate or on rose (to specify if right or left)
- Maniglia con rosette senza bocchette / Lever handle on rose without rose for key
- Coppie impugnature (CM) con grano e ferro senza rosette e senza bocchette / Pair levers (CM) with grub screws and square pin without rose and without rose for key

art. 274 SLIM

design: Marco Pialorsi
materiale: Ottone
material: Solid Brass

Brass Class
100% Ottone



274 MR 009 OSC



274 MR Q08 OC



274 MR 006 OC



274 MP 188 LV

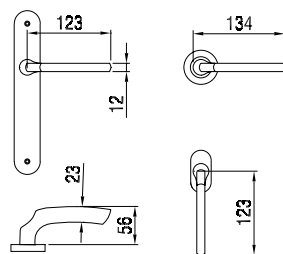

274 DK 015 LV

VERSIONI / VERSIONS



Finiture
Finishes

MANIGLIA CON PLACCA / LEVER HANDLE ON PLATE				LV BG OS	OSC OC	
274 MP 188	Maniglia con placca Lever Handle on plate	188 mm 255x42	con molla e grano with spring and grub screw	•	•	1
274 MP 130	Maniglia con placca Lever Handle on plate	130 mm 245x50	con molla e grano with spring and grub screw	•	•	1
MANIGLIA CON ROSETTA / LEVER HANDLE ON ROSE						
274 MR 004	Maniglia con rosetta Lever Handle on rose	004 mm Ø45x9	con molla e grano with spring and grub screw	•	•	2
274 MR 006	Maniglia con rosetta Lever Handle on rose	006 mm Ø50x8	tipo lusso con molla e grano lusso type with spring and grub screw	•	•	1
274 MR 008	Maniglia con rosetta Lever Handle on rose	008 mm Ø50x8	con molla e grano with spring and grub screw	•	•	2
274 MR 009	Maniglia con rosetta Lever Handle on rose	009 mm 62x32	ovale con molla e grano oval with spring and grub screw	•	•	1
274 MR Q08	Maniglia con rosetta Lever Handle on rose	Q08 mm 50x50	con molla e grano with spring and grub screw	•	•	1
274 MR Q09	Maniglia con rosetta Lever Handle on rose	Q09 mm 61x31	con molla e grano with spring and grub screw	•	•	1
CREMONESE / WINDOW HANDLE WITH MECHANISM						
274 SG 070*	Cremonese con placca Window Handle on plate	070 mm 189x36	coprivite con gioco with cover-screw plate with mechanism	•	•	2
274 SG Q13	Cremonese con placca Window Handle on plate	Q13 mm 160x33	coprivite con gioco with cover-screw plate with mechanism	•	•	2
MARTELLINA / WINDOW HANDLE WITHOUT MECHANISM						
274 SE 070*	Martellina con placca Window Handle on plate	070 mm 189x36	coprivite q.7 with cover-screw plate with square-pin mm 7	•	•	2
274 SE Q13	Martellina con placca Window Handle on plate	Q13 mm 160x33	coprivite q.7 with cover-screw plate with square-pin mm 7	•	•	2
DREH KIPP / DREH KIPP						
274 DK 015	Dreh Kipp con rosetta Dreh Kipp on rose	015 mm 65x31	con movimento in metallo with metal mechanism	•	•	3
274 DK Q15	Dreh Kipp con rosetta Dreh Kipp on rose	Q15 mm 65x31	con movimento in metallo with metal mechanism	•	•	3

A RICHIESTA / ON REQUEST:

- Mezza maniglia con placca o con rosetta (specificare se destra o sinistra) / Half lever handle on plate or on rose (to specify if right or left)
- Maniglia con rosette senza bocchette / Lever handle on rose without rose for key
- Coppie impugnature (CM) con grano e ferro senza rosette e senza bocchette / Pair levers (CM) with grub screws and square pin without rose and without rose for key

art.275 EVA

design: Studio Reguitti
materiale: Impugnatura Zama
material: Lever Zamak

TeKnoMetal
Linea in zama

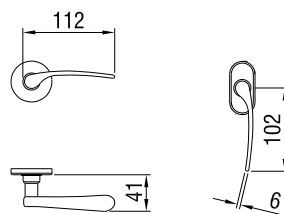

275 MR 008 ZSC



275 MR 005 SNV



275 MR 009 SNV

destro / right



275 DK 015 ZSC

VERSIONI / VERSIONS



Finiture
Finishes

MANIGLIA SU ROSETTA / LEVER HANDLE ON ROSE

				ZSC	SNV		
	275 MR 004	Maniglia con rosetta Lever Handle on rose	004 mm Ø45X9	con molla e grano with spring and grub screw	•	•	5
	275 MR 005	Maniglia con rosetta Lever Handle on rose	005 mm Ø50x8	con molla e grano with spring and grub screw	•	•	2
	275 MR 008	Maniglia con rosetta Lever Handle on rose	008 mm Ø50x8	con molla e grano with spring and grub screw	•	•	2
	275 MR 009	Maniglia con rosetta Lever Handle on rose	009 mm 62x32	con molla e grano with spring and grub screw	•	•	1
	275 MR 416	Maniglia con rosetta Lever Handle on rose	416 mm Ø50x9	con molla e grano with spring and grub screw	•	•	5

CREMONESE / WINDOW HANDLE WITH MECHANISM

	275 SG 070*	Cremonese con placca Window Handle on plate	070 mm 189x36	coprivite con gioco with cover-screw plate with mechanism	•	•	2
--	-------------	--	---------------	--	---	---	---

MARTELLINA / WINDOW HANDLE WITHOUT MECHANISM

	275 SE 070*	Martellina con placca Window Handle on plate	070 mm 189x36	coprivite q.7 with cover-screw plate with square-pin mm 7	•	•	2
--	-------------	---	---------------	--	---	---	---

DREH KIPP / DREH KIPP

	275 DK 015	Dreh Kipp destro con rosetta Dreh Kipp (right) on rose	015 mm 65x31	con movimento in metallo with metal mechanism	•	•	6
--	------------	---	--------------	--	---	---	---

* Placca adatta a movimenti intercambiabili - Plate suitable to interchangeable movements

A RICHIESTA / ON REQUEST:

- Mezza maniglia con placca o con rosetta (specificare se destra o sinistra) / Half lever handle on plate or on rose (to specify if right or left)
- Maniglia con rosette senza bocchette / Lever handle on rose without rose for key
- Coppie impugnature (CM) con grano e ferro senza rosette e senza bocchette / Pair levers (CM) with grub screws and square pin without rose and without rose for key

art. 288 COMBY

design: Studio Reguitti
materiale: Ottone
material: Solid Brass

Brass Class
100% Ottone



288 MR 006 OS/LV



rosetta OSC

288 MR 416 OSC/OC/OSC



288 MR 006 OSC/OC



placca OSC

288 MP 188 OSC/OC/OSC

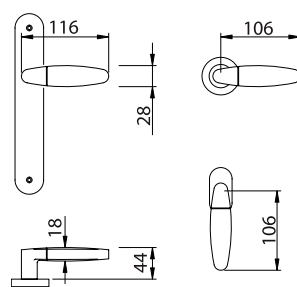

rosetta OSC

288 DK 015 OSC/OC/OSC

VERSIONI / VERSIONS



Finiture
Finishes

				OS/LV	OSC/OC	OSC/OC Base sat. cromato	
MANIGLIA CON PLACCA / LEVER HANDLE ON PLATE							
288 MP 188	Maniglia con placca Lever Handle on plate	188 mm 255X42	con molla e grano with spring and grub screw	•	•	•	1
288 MP 248	Maniglia con placca Lever Handle on plate	248 mm 248x50	con molla e grano with spring and grub screw	•	•	•	1
MANIGLIA CON ROSETTA / LEVER HANDLE ON ROSE							
288 MR 006	Maniglia con rosetta Lever Handle on rose	006 mm Ø50x8	tipo lusso con molla e grano lusso type with spring and grub screw	•	•	•	1
288 MR 009	Maniglia con rosetta Lever Handle on rose	009 mm 62x32	ovale con molla e grano oval with spring and grub screw	•	•	•	1
288 MR 416	Maniglia con rosetta Lever Handle on rose	416 mm Ø45x9	con molla e grano with spring and grub screw	•	•	•	1
288 MR 816	Maniglia con rosetta Lever Handle on rose	816 mm Ø50x10	con molla e grano with spring and grub screw	•	•	•	1
CREMONESE / WINDOW HANDLE WITH MECHANISM							
288 SG 070*	Cremonese con placca Window Handle on plate	070 mm 189x36	coprivite con gioco with cover-screw plate with mechanism	•	•	•	2
MARTELLINA / WINDOW HANDLE WITHOUT MECHANISM							
288 SE 070*	Martellina con placca Window Handle on plate	070 mm 189x36	coprivite q. 7 with cover-screw plate with square-pin mm 7	•	•	•	2
DREH KIPP / DREH KIPP							
288 DK 015	Dreh Kipp con rosetta Dreh Kipp on rose	015 mm 65x31	con movimento in metallo with metal mechanism	•	•	•	3

* Placca adatta a movimenti intercambiabili
Plate suitable to interchangeable movements

A RICHIESTA / ON REQUEST:

- Mezza maniglia con placca o con rosetta (specificare se destra o sinistra) / Half lever handle on plate or on rose (to specify if right or left)
- Maniglia con rosette senza bocchette / Lever handle on rose without rose for key
- Coppie impugnature (CM) con grano e ferro senza rosette e senza bocchette / Pair levers (CM) with grub screws and square pin without rose and without rose for key

art. 336 WALTHAM

design: Studio Reguitti
 materiale: Impugnatura Zama
 material: Lever Zamak

TeKnoMetal
 Linea in zama



336 MR 008 ZCR



336 MR 006 ZSC



336 MR 416 ZSC



336 MR 008 ZSC



336 MR 916 ZCR

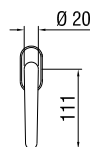
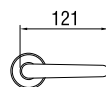

336 DK C67 ZSC



336 DK 015 ZCR

VERSIONI / VERSIONS



Finiture
 Finishes

MANIGLIA SU ROSETTA / LEVER HANDLE ON ROSE

				ZSC	ZCR		
	336 MR 004	Maniglia con rosetta Lever Handle on rose	004 mm Ø45x9	con molla e grano with spring and grub screw	•	•	1
	336 MR 006	Maniglia con rosetta Lever Handle on rose	006 mm Ø50x8	con molla e grano with spring and grub screw	•	•	1
	336 MR 008	Maniglia con rosetta Lever Handle on rose	008 mm Ø50x8	con molla e grano with spring and grub screw	•	•	1
	336 MR 009	Maniglia con rosetta Lever Handle on rose	009 mm 62x32	con molla e grano with spring and grub screw	•	•	1
	336 MR 416	Maniglia con rosetta Lever Handle on rose	416 mm Ø45x9	con molla e grano with spring and grub screw	•	•	1
	336 MR 916	Maniglia con rosetta Lever Handle on rose	916 mm 62x32	con molla e grano with spring and grub screw	•	•	1

CREMONESE / WINDOW HANDLE WITH MECHANISM

	336 SG 070*	Cremonese con placca Window Handle on plate	070 mm 189x36	coprivite con gioco with cover-screw plate with mechanism	•	•	2
--	-------------	--	---------------	--	---	---	---

MARTELLINA / WINDOW HANDLE WITHOUT MECHANISM

	336 SE 070*	Martellina con placca Window Handle on plate	070 mm 189x36	coprivite q.7 with cover-screw plate with square-pin mm 7	•	•	2
--	-------------	---	---------------	--	---	---	---

DREH KIPP / DREH KIPP

	336 DK 015	Dreh Kipp con rosetta Dreh Kipp on rose	015 mm 65x31	con movimento in metallo with metal mechanism	•	•	3
	336 DK C67	Dreh Kipp con rosetta Dreh Kipp on rose	C67 mm 69x33	c/chiave, cilindro e movimento in metallo with key and cylinder and metal mechanism	•	•	1

* Placca adatta a movimenti intercambiabili - Plate suitable to interchangeable movements

A RICHIESTA / ON REQUEST:

- Mezza maniglia con placca o con rosetta (specificare se destra o sinistra) / Half lever handle on plate or on rose (to specify if right or left)
- Maniglia con rosette senza bocchette / Lever handle on rose without rose for key
- Coppie impugnature (CM) con grano e ferro senza rosette e senza bocchette / Pair levers (CM) with grub screws and square pin without rose and without rose for key

art. 337 WINCHESTER

design: Studio Reguitti
 materiale: Impugnatura Zama
 material: Lever Zamak

TeKnoMetal
 Linea in zama

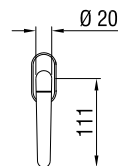
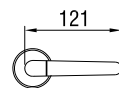

337 MR 416 ZSC / ZCR



337 MR 006 ZSC/ZCR



337 MR 008 PVD SAT./PVD



337 MR 008 ZSC/ZCR



337 MR 916 ZSC/ZCR



337 MR 009 ZSC/ZCR



337 MR 004 ZSC/ZCR



337 DK C67 ZSC/ZCR



337 DK 015 PVD SAT./PVD



MANIGLIA SU ROSETTA / LEVER HANDLE ON ROSE

	337 MR 004	Maniglia con rosetta <i>Lever Handle on rose</i>	004 mm Ø45X9	con molla e grano <i>with spring and grub screw</i>	•	•	1
	337 MR 006	Maniglia con rosetta <i>Lever Handle on rose</i>	006 mm Ø50x8	con molla e grano <i>with spring and grub screw</i>	•	•	1
	337 MR 008	Maniglia con rosetta <i>Lever Handle on rose</i>	008 mm Ø50x8	con molla e grano <i>with spring and grub screw</i>	•	•	1
	337 MR 009	Maniglia con rosetta <i>Lever Handle on rose</i>	009 mm 62x32	con molla e grano <i>with spring and grub screw</i>	•	•	1
	337 MR 416	Maniglia con rosetta <i>Lever Handle on rose</i>	416 mm Ø49X9	con molla e grano <i>with spring and grub screw</i>	•	•	1
	337 MR 916	Maniglia con rosetta <i>Lever Handle on rose</i>	916 mm 62x32	con molla e grano <i>with spring and grub screw</i>	•	•	1

CREMONESE / WINDOW HANDLE WITH MECHANISM

	337 SG 070*	Cremonese con placca <i>Window Handle on plate</i>	070 mm 189x36	coprivite con gioco <i>with cover-screw plate with mechanism</i>	•		2
---	-------------	---	---------------	---	---	--	---

MARTELLINA / WINDOW HANDLE WITHOUT MECHANISM

	337 SE 070*	Martellina con placca <i>Window Handle on plate</i>	070 mm 189x36	coprivite q.7 <i>with cover-screw plate with square-pin mm 7</i>	•		2
---	-------------	--	---------------	---	---	--	---

DREH KIPP / DREH KIPP

	337 DK 015	Dreh Kipp con rosetta <i>Dreh Kipp on rose</i>	015 mm 65x31	con movimento in metallo <i>with metal mechanism</i>	•	•	3
	337 DK C67	Dreh Kipp con rosetta <i>Dreh Kipp on rose</i>	C67 mm 69x33	c/chiave, cilindro e movimento in metallo <i>with key and cylinder and metal mechanism</i>	•	•	1

* Placca adatta a movimenti intercambiabili
Plate suitable to interchangeable movements

Per caratteristiche tecniche rosette vedi apposito capitolo soluzioni tecniche e componenti / For technical specifications rosettes see specific section technical solutions and components

A RICHIESTA / ON REQUEST:

- Mezza maniglia con placca o con rosetta (specificare se destra o sinistra) / Half lever handle on plate or on rose (to specify if right or left)
- Maniglia con rosette senza bocchette / Lever handle on rose without rose for key
- Coppie impugnature (CM) con grano e ferro senza rosette e senza bocchette / Pair levers (CM) with grub screws and square pin without rose and without rose for key

art. 342 BRIXTON

design: Studio Reguitti
materiale: Impugnatura Zama
material: Lever Zamak

TeKnoMetal
Linea in zama

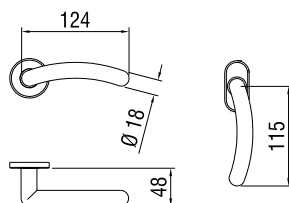

342 MR 004 ZCR



342 MR 008 ZSC



342 MR 006 ZSC

destro / right



342 DK 015 ZSC

VERSIONI / VERSIONS



Finiture
Finishes

MANIGLIA SU ROSETTA / LEVER HANDLE ON ROSE



Model	Description	Dimensions	Material	ZSC	ZCR	Quantity
342 MR 004	Maniglia con rosetta Lever Handle on rose	004 mm Ø45x9	con molla e grano with spring and grub screw	•	•	5
342 MR 006	Maniglia con rosetta Lever Handle on rose	006 mm Ø50x8	con molla e grano with spring and grub screw	•	•	2
342 MR 008	Maniglia con rosetta Lever Handle on rose	008 mm Ø50x8	con molla e grano with spring and grub screw	•	•	2
342 MR 009	Maniglia con rosetta Lever Handle on rose	009 mm 62x32	con molla e grano with spring and grub screw	•	•	1
342 MR 416	Maniglia con rosetta Lever Handle on rose	416 mm Ø45x9	con molla e grano with spring and grub screw	•	•	5



CREMONESE / WINDOW HANDLE WITH MECHANISM



342 SG 070*	Cremonese con placca Window Handle on plate	070 mm 189x36	coprivite con gioco with cover-screw plate with mechanism	•	•	2
-------------	--	---------------	--	---	---	---

MARTELLINA / WINDOW HANDLE WITHOUT MECHANISM



342 SE 070*	Martellina con placca Window Handle on plate	070 mm 189x36	coprivite q.7 with cover-screw plate with square-pin mm 7	•	•	2
-------------	---	---------------	--	---	---	---

DREH KIPP / DREH KIPP



342 DK 015	Dreh Kipp destro con rosetta Dreh Kipp (right) on rose	015 mm 65x31	con movimento in metallo with metal mechanism	•	•	3
342 DK C67	Dreh Kipp destro con rosetta Dreh Kipp (right) on rose	C67 mm 69x33	c/chiave, cilindro e movimento in metallo with key and cylinder and metal mechanism	•	•	1

* Placca adatta a movimenti intercambiabili
Plate suitable to interchangeable movements

art. 343 BRIXTON B

design: Studio Reguitti
 materiale: Impugnatura Zama
 material: Lever Zamak

TeKnoMetal
 Linea in zama



343 MR 004 - ZSC/ZCR

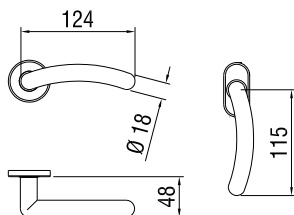

destro / right



343 MR 006 - ZSC/ZCR



343 MR 009 - ZSC/ZCR





343 DK 015 - ZSC/ZCR

VERSIONI / VERSIONS



MANIGLIA CON ROSETTA / LEVER HANDLE ON ROSE

				ZSC/ZCR	
	343 MR 004	Maniglia con rosetta Lever handle on rose	004 mm Ø45x9	con molla with spring	•
	343 MR 006	Maniglia con rosetta Lever handle on rose	006 mm Ø50x8	tipo lusso con molla lusso type with spring	• 2
	343 MR 008	Maniglia con rosetta Lever handle on rose	008 mm Ø50x8	con molla with spring	• 2
	343 MR 009	Maniglia con rosetta Lever handle on rose	009 mm 62x32	ovale con molla oval with spring	• 1
	343 MR 416	Maniglia con rosetta Lever handle on rose	416 mm Ø45x9	con molla with spring	• 1

MARTELLINA / WINDOW HANDLE WITHOUT MECHANISM

	343 SE 070*	Martellina con placca Martellina on plate	070 mm 189x36	coprivite q.7 with cover-screw plate and sq.-pin mm 7	• 2

CREMONESE / WINDOW HANDLE WITH MECHANISM

	343 SG 070*	Cremonese con placca Cremon on plate	070 mm 189x36	coprivite con gioco with cover-screw plate with mechanism	• 2

DREH KIPP / DREH KIPP

	343 DK 015	Dreh Kipp destro con rosetta Dreh Kipp (right) on rose	015 mm 65x31	con movimento in metallo with metal mechanism	•

* Placca adatta a movimenti intercambiabili
 Plate suitable to interchangeable movements

Per caratteristiche tecniche rosette vedi apposito capitolo soluzioni tecniche e componenti / For technical specifications rosettes see specific section technical solutions and components

art. 347 CLEO

design: Studio Reguitti
materiale: Ottone
material: Solid Brass

Brass Class
100% Ottone



347 MR 006 LV



347 MR 009 LV



347 MR 006 OC



347 MR 008 OSC



347 MR 004 BG



347 MR 416 OSC



347 MP 248 OC

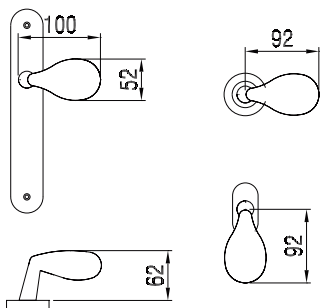

347 SE 070 OC
347 SG 070 OC



347 DK 015 OC



					LV	BG	OSC OC	PVD	PVD INOX	
MANIGLIA CON PLACCA / LEVER HANDLE ON PLATE										
	347 MP 049	Maniglia con placca Lever Handle on plate	049	mm265x55	con molla e grano with spring and grub screw	•	•	•	•	1
	347 MP 188	Maniglia con placca Lever Handle on plate	188	mm 255x42	con molla e grano with spring and grub screw	•	•	•	•	1
	347 MP 248	Maniglia con placca Lever Handle on plate	248	mm 248x50	con molla e grano with spring and grub screw	•	•			1
	347 MP 702	Maniglia con placca Lever Handle on plate	702	mm 225x42	con molla e grano with spring and grub screw				•	1
MANIGLIA CON ROSETTA / LEVER HANDLE ON ROSE										
	347 MR 004	Maniglia con rosetta Lever Handle on rose	004	mm Ø45x9	con molla e grano with spring and grub screw	•	•	•		1
	347 MR 006	Maniglia con rosetta Lever Handle on rose	006	mm Ø50x8	tipo lusso con molla e grano lusso type with spring and grub screw	•	•	•	•	1
	347 MR 008	Maniglia con rosetta Lever Handle on rose	008	mm Ø50x8	con molla e grano with spring and grub screw	•	•		•	1
	347 MR 009	Maniglia con rosetta Lever Handle on rose	009	mm 62x32	ovale con molla e grano oval with spring and grub screw	•	•	•	•	1
	347 MR 416	Maniglia con rosetta Lever Handle on rose	416	mm Ø45x9	con molla e grano with spring and grub screw	•	•	•		1
CREMONESE / WINDOW HANDLE WITH MECHANISM										
	347 SG 070*	Cremonese con placca Window Handle on plate	070	mm 189x36	coprivite con gioco with cover-screw plate with mechanism	•	•			2
MARTELLINA / WINDOW HANDLE WITHOUT MECHANISM										
	347 SE 070*	Martellina con placca Window Handle on plate	070	mm 189x36	coprivite q. 7 with cover-screw plate with square-pin mm 7	•	•			2
DREH KIPP / DREH KIPP										
	347 DK 015	Dreh Kipp con rosetta Dreh Kipp on rose	015	mm 65x31	con movimento in metallo with metal mechanism	•	•	•	•	3

* Placca adatta a movimenti intercambiabili
Plate suitable to interchangeable movements



347 MP 188 OSC



347 MP 049 LV



347 MP 702 PVD INOX

Per caratteristiche tecniche rosette vedi apposito capitolo soluzioni tecniche e componenti / For technical specifications rosettes see specific section technical solutions and components

A RICHIESTA / ON REQUEST:

- Mezza maniglia con placca o con rosetta (specificare se destra o sinistra) / Half lever handle on plate or on rose (to specify if right or left)
- Maniglia con rosette senza bocchette / Lever handle on rose without rose for key
- Coppie impugnature (CM) con grano e ferro senza rosette e senza bocchette / Pair levers (CM) with grub screws and square pin without rose and without rose for key

art. 348 ENTRY

design: Studio Reguitti
 materiale: Ottone
 material: Solid Brass

Brass Class
 100% Ottone

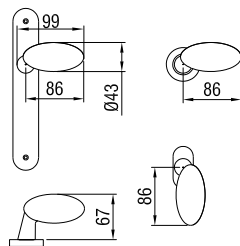

348MR 416 OSC



348 MR 006 LV



348 MR 006 OC



348 MR 416 BG



348 MR 916 OSC



348 MP 188 OSC

destra / right



348 DK C67 OSC

destra / right



348 DK 015 OSC

VERSIONI / VERSIONS



MANIGLIA CON PLACCA / LEVER HANDLE ON PLATE

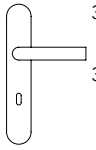

348 MP 049	Maniglia con placca Lever Handle on plate	049 mm 265x55	con molla e grano with spring and grub screw	•	•	•	•	1
348 MP 188	Maniglia con placca Lever Handle on plate	188 mm 255x42	molla e grano with spring and grub screw	•	•	•	•	1
348 MP 248	Maniglia con placca Lever Handle on plate	248 mm 248x50	molla e grano with spring and grub screw	•	•			1

MANIGLIA SU ROSETTA / LEVER HANDLE ON ROSE



348 MR 006	Maniglia con rosetta Lever Handle on rose	006 mm Ø50x8	con molla e grano with spring and grub screw	•	•	•	•	1
 348 MR 416	Maniglia con rosetta Lever Handle on rose	416 mm Ø45x9	con molla e grano with spring and grub screw	•	•	•	•	1
 348 MR 816	Maniglia con rosetta Lever Handle on rose	816 mm Ø50x10	con molla e grano with spring and grub screw	•	•	•	•	1
 348 MR 916	Maniglia con rosetta Lever Handle on rose	916 mm 62x32	con molla e grano with spring and grub screw	•	•	•	•	1

CREMONESE / WINDOW HANDLE WITH MECHANISM



348 SG 070*	Cremonese con placca Window Handle on plate	070 mm 189x36	coprivite con gioco with cover-screw plate with mechanism	•	•			2
-------------	--	---------------	--	---	---	--	--	---

MARTELLINA / WINDOW HANDLE WITHOUT MECHANISM



348 SE 070*	Martellina con placca Window Handle on plate	070 mm 189x36	coprivite q.7 with cover-screw plate with square-pin mm 7	•	•			2
-------------	---	---------------	--	---	---	--	--	---

DREH KIPP / DREH KIPP



348 DK 015	Dreh Kipp destro con rosetta Dreh Kipp (right) on rose	015 mm 65x31	con movimento in metallo with metal mechanism	•	•	•	•	2
348 DK C67	Dreh Kipp destro con rosetta Dreh Kipp (right) on rose	C67 mm 69x33	c/chiave, cilindro e movimento in metallo with key and cylinder and metal mechanism	•	•	•	•	1

* Placca adatta a movimenti intercambiabili
Plate suitable to interchangeable movements

Per caratteristiche tecniche rosette vedi apposito capitolo soluzioni tecniche e componenti / For technical specifications rosettes see specific section technical solutions and components

A RICHIESTA / ON REQUEST:

- Mezza maniglia con placca o con rosetta (specificare se destra o sinistra) / Half lever handle on plate or on rose (to specify if right or left)
- Maniglia con rosette senza bocchette / Lever handle on rose without rose for key
- Coppie impugnature (CM) con grano e ferro senza rosette e senza bocchette / Pair levers (CM) with grub screws and square pin without rose and without rose for key

art. 370 MAYFAIR

design: Studio Reguitti
materiale: Acciaio Inox / Ottone
material: Stainless Steel / Solid Brass

Brass Class
100% Ottone

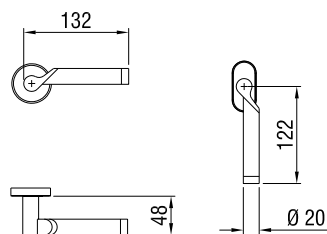

370 MR 816 PVD SAT. / PVD



370 MR 916 INOX SAT. / OC

destro / right



370 DK C67 INOX SAT. / OC

destro / right



370 DK 015 INOX SAT. / OC

VERSIONI / VERSIONS



Finiture
Finishes

MANIGLIA SU ROSETTA / LEVER HANDLE ON ROSE					INOX SAT. / OC	PVD SAT / PVD	
	370 MR 416	Maniglia con rosetta <i>Lever Handle on rose</i>	416 mm Ø45X9	con molla e grano <i>with spring and grub screw</i>	•	•	1
	370 MR 816	Maniglia con rosetta <i>Lever Handle on rose</i>	816 mm Ø50x10	con molla e grano <i>with spring and grub screw</i>	•	•	1
	370 MR 916	Maniglia con rosetta <i>Lever Handle on rose</i>	916 mm 62x32	con molla e grano <i>with spring and grub screw</i>	•	•	1
CREMONESE / WINDOW HANDLE WITH MECHANISM							
	370 SG 070*	Cremonese con placca <i>Window Handle on plate</i>	070 mm 189x36	coprivite con gioco <i>with cover-screw plate with mechanism</i>	•		2
MARTELLINA / WINDOW HANDLE WITHOUT MECHANISM							
	370 SE 070*	Martellina con placca <i>Window Handle on plate</i>	070 mm 189x36	coprivite q.7 <i>with cover-screw plate with square-pin mm 7</i>	•		2
DREH KIPP / DREH KIPP							
	370 DK 015	Dreh Kipp destro con rosetta <i>Dreh Kipp (right) on rose</i>	015 mm 65x31	con movimento in metallo <i>with metal mechanism</i>	•	•	3
	370 DK C67	Dreh Kipp destro con rosetta <i>Dreh Kipp (right) on rose</i>	C67 mm 69x33	c/chiave, cilindro e movimento in metallo <i>with key and cylinder and metal mechanism</i>	•	•	1

* Placca adatta a movimenti intercambiabili
Plate suitable to interchangeable movements

Per caratteristiche tecniche rosette vedi apposito capitolo soluzioni tecniche e componenti / For technical specifications rosettes see specific section technical solutions and components

A RICHIESTA / ON REQUEST:

- Mezza maniglia con placca o con rosetta (specificare se destra o sinistra) / Half lever handle on plate or on rose (to specify if right or left)
- Maniglia con rosette senza bocchette / Lever handle on rose without rose for key
- Coppie impugnature (CM) con grano e ferro senza rosette e senza bocchette / Pair levers (CM) with grub screws and square pin without rose and without rose for key

art. 382 GENTILE

design: Studio Reguitti
 materiale: Ottone
 material: Solid Brass

Brass Class
 100% Ottone

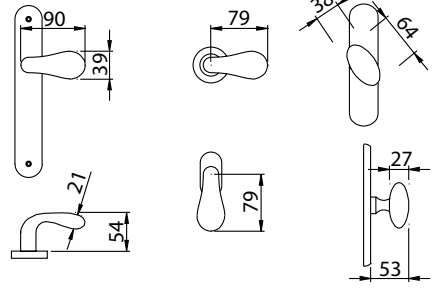

382 MR 382 OSC/OC



382 MR 416 LV



382 MR 009 OSC



382 MR 382 OC/OSC



382 MR 382 OC/LV



382 MR 006 OC



382 MR 006 BG



382 MP 037 LV



382 MA 070 LV
 382 CR 070 LV



382 DK 015 LV

Finiture
Finishes

						LV	BG	OSC OC	OC/LV OSC/OC OC/OSC	PVD	
MANIGLIA CON PLACCA / LEVER HANDLE ON PLATE											
	382 MP 037	Maniglia con placca Lever Handle on plate	037	mm 255x42	con molla e grano with spring and grub screw	•	•				1
	382 MP 188	Maniglia con placca Lever Handle on plate	188	mm 255x42	con molla e grano with spring and grub screw					•	1
	382 MP 248	Maniglia con placca Lever Handle on plate	248	mm 248x50	con molla e grano with spring and grub screw	•	•			•	1
MANIGLIA CON ROSETTA / LEVER HANDLE ON ROSE											
	382 MR 006	Maniglia con rosetta Lever Handle on rose	006	mm Ø50x8	tipo lusso con molla e grano lusso type with spring and grub screw	•	•	•	•	•	1
	382 MR 009	Maniglia con rosetta Lever Handle on rose	009	mm 62x32	ovale con molla e grano oval with spring and grub screw	•	•			•	1
	382 MR 382	Maniglia con rosetta Lever Handle on rose	382	mm Ø50x8	profilo a campana con molla e grano original profile with spring and grub screw	•	•	•	•	•	1
	382 MR 416	Maniglia con rosetta Lever Handle on rose	416	mm Ø45x9	con molla e grano with spring and grub screw	•	•	•	•	•	1
	382 MR 916	Maniglia con rosetta Lever Handle on rose	916	mm 62x32	ovale con molla e grano oval with spring and grub screw	•	•			•	1
CREMONESE / WINDOW HANDLE WITH MECHANISM											
	382 CR 137	Cremonese con placca Window Handle on plate	137	mm 167x40	con fori viti con gioco with holes for screws with mechanism	•	•				2
	382 CR 070*	Cremonese con placca Window Handle on plate	070	mm 189x36	coprivite con gioco with cover-screw plate with mechanism	•	•				2
MARTELLINA / WINDOW HANDLE WITHOUT MECHANISM											
	382 MA 137	Martellina con placca Window Handle on plate	137	mm 167x40	con fori viti q.7 with holes for screws with square-pin mm 7	•	•				2
	382 MA 070*	Martellina con placca Window Handle on plate	070	mm 189x36	coprivite q.7 with cover-screw plate with square-pin mm 7	•	•				2
DREH KIPP / DREH KIPP											
	382 DK 015	Dreh Kipp destro con rosetta Dreh Kipp right on rose	015	mm 65x31	con movimento in metallo with metal mechanism	•	•			•	3
	382 DK C67	Dreh Kipp con rosetta Safety DK on rose	C67	mm 69x33	c/chave e cilindro e movimento in metallo with key and cylinder and metal mechanism	•	•			•	1

* Placca adatta a movimenti intercambiabili
Plate suitable to interchangeable movements



382 DK C67 LV



382 MP 248 LV



382 MR 916 OSC

Per caratteristiche tecniche rosette vedi apposito capitolo soluzioni tecniche e componenti / For technical specifications rosettes see specific section technical solutions and components

A RICHIESTA / ON REQUEST:

- Mezza maniglia con placca o con rosetta (specificare se destra o sinistra) / Half lever handle on plate or on rose (to specify if right or left)
- Maniglia con rosette senza bocchette / Lever handle on rose without rose for key
- Coppie impugnature (CM) con grano e ferro senza rosette e senza bocchette / Pair levers (CM) with grub screws and square pin without rose and without rose for key
- Cremonesi e martelline con impugnatura a maniglia (segretini)

art. 422 Q-UBIK

design: Studio Reguitti
 materiale: Ottone
 material: Solid Brass

Brass Class
 100% Ottone

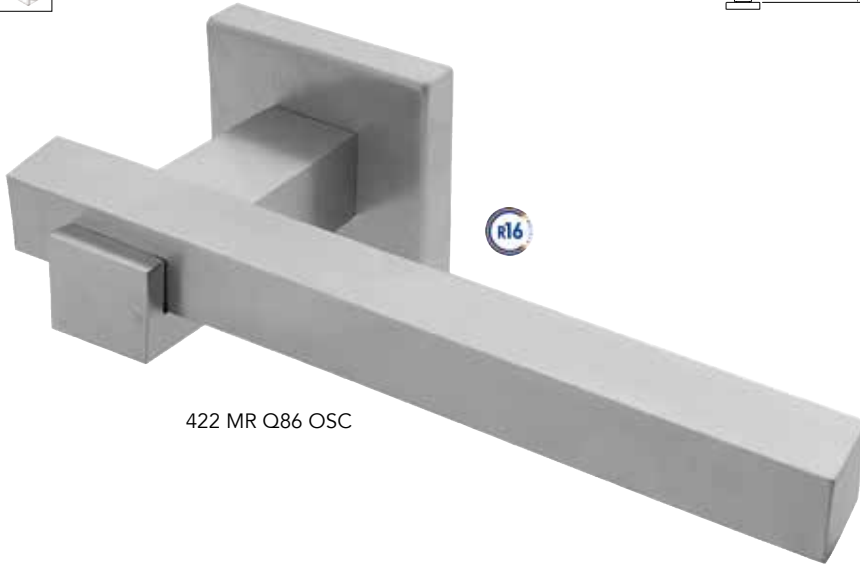
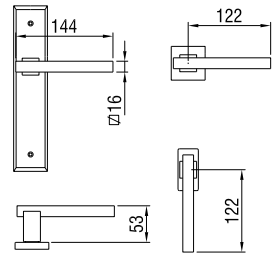

422 MR Q86 OSC



422 MR 816 LV



422 MR Q86 OC



422 MR Q86 OSC/OC



422 MR 9Q6 OSC



422 MP 130 OSC

destra / right

destra / right



422 DK Q15 OSC



422 DK Q75 OSC



					LV	OSC OC	OSC/OC	
MANIGLIA CON PLACCA / LEVER HANDLE ON PLATE								
	422 MP 130	Maniglia con placca Lever Handle on plate	130 mm 245x50	con molla e grano with spring and grub screw	•	•	•	1
MANIGLIA SU ROSETTA / LEVER HANDLE ON ROSE								
	422 MR 816	Maniglia con rosetta Lever Handle on rose	816 mm Ø50X10	con molla e grano with spring and grub screw	•	•	•	1
	422 MR 9Q6	Maniglia con rosetta Lever Handle on rose	9Q6 mm 61x31	con molla e grano with spring and grub screw	•	•	•	1
	422 MR Q86	Maniglia con rosetta Lever Handle on rose	Q86 mm 50x50	con molla e grano with spring and grub screw	•	•	•	1
CREMONESE / WINDOW HANDLE WITH MECHANISM								
	422 SG Q13*	Cremonese con placca Window Handle on plate	Q13 mm 160X33	coprivite con gioco with cover-screw plate with mechanism	•	•	•	2
MARTELLINA / WINDOW HANDLE WITHOUT MECHANISM								
	422 SE Q13*	Martellina con placca Window Handle on plate	Q13 mm 160X33	coprivite q.7 with cover-screw plate with square-pin mm 7	•	•	•	2
DREH KIPP / DREH KIPP								
	422 DK Q15	Dreh Kipp destro con rosetta Dreh Kipp (right) on rose	Q15 mm 65x31	con movimento in metallo with metal mechanism	•	•	•	2
	422 DK C70	Dreh Kipp destro con rosetta Dreh Kipp (right) on rose	C70 mm 69x33	c/chiave, cilindro e movimento in metallo with key and cylinder and metal mechanism	•	•	•	1
	422 DK Q75	Dreh Kipp destro con rosetta Dreh Kipp (right) on rose	Q75 mm 64x30	con mov. securblock e puls. di sicurezza with securblock system and push button	•	•	•	2

* Placca adatta a movimenti intercambiabili - Plate suitable to interchangeable movements

**REQUITTI CONSIGLIA
RECOMMEND BY REQUITTI**



124 PF Q08 OSC
VEDI CAPITOLO "PORTE D'ENTRATA"
SEE CHAPTER "ENTRANCE DOORS"



FERRO CDF6
SISTEMA CON GRANO PERFORANTE
FORNITO DI SERIE SU QUESTO
MODELLO

Per caratteristiche tecniche rosette vedi apposito capitolo soluzioni tecniche e componenti / For technical specifications rosettes see specific section technical solutions and components

A RICHIESTA / ON REQUEST:

- Mezza maniglia con placca o con rosetta (specificare se destra o sinistra) / Half lever handle on plate or on rose (to specify if right or left)
- Maniglia con rosette senza bocchette / Lever handle on rose without rose for key
- Coppie impugnature (CM) con grano e ferro senza rosette e senza bocchette / Pair levers (CM) with grub screws and square pin without rose and without rose for key

art. 423 Q-PLUS

design: Marco Pialorsi
materiale: Ottone
material: Solid Brass

Brass Class
100% Ottone



423 MR Q86 OSC



423 MR Q86 LV



423 MR Q86 OC



423 MR 9Q6 OC



423 MR 816 OSC

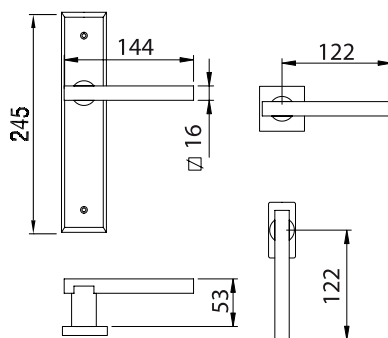

423 MP 130 OSC



423 DK Q15 OSC



				LV	OSC OC		
MANIGLIA CON PLACCA / LEVER HANDLE ON PLATE							
	423 MP 130	Maniglia con placca Lever Handle on plate	130 mm 245x50	con molla e grano with spring and grub screw	•	•	1
MANIGLIA CON ROSETTA QUADRATA / LEVER HANDLE ON SQUARE ROSE							
	423 MR 816	Maniglia con rosetta Lever Handle on rose	816 mm Ø50x10	con molla e grano with spring and grub screw	•	•	1
	423 MR 9Q6	Maniglia con rosetta Lever Handle on rose	9Q6 mm 61x31	con molla e grano with spring and grub screw	•	•	1
	423 MR Q86	Maniglia con rosetta Lever Handle on rose	Q86 mm 50x50	con molla e grano with spring and grub screw	•	•	1
CREMONESE / WINDOW HANDLE WITH MECHANISM							
	423 SG Q13*	Cremonese con placca Window Handle on plate	Q13 mm 160x33	coprivite con gioco with cover-screw plate with mechanism	•	•	2
MARTELLINA / WINDOW HANDLE WITHOUT MECHANISM							
	423 SE Q13*	Martellina con placca Window Handle on plate	Q13 mm 160x33	coprivite q.7 with cover-screw plate with square-pin mm 7	•	•	2
DREH KIPP / DREH KIPP							
	423 DK Q15	Dreh Kipp con rosetta Dreh Kipp on rose	Q15 mm 65x31	con movimento in metallo with metal mechanism	•	•	2

* Placca adatta a movimenti intercambiabili
Plate suitable to interchangeable movements



Vedi capitolo "Porte scorrevoli"
See chapter "Sliding doors"

305 MD Q11 OSC

Per caratteristiche tecniche rosette vedi apposito capitolo soluzioni tecniche e componenti / For technical specifications rosettes see specific section technical solutions and components

A RICHIESTA / ON REQUEST:

- Mezza maniglia con placca o con rosetta (specificare se destra o sinistra) / Half lever handle on plate or on rose (to specify if right or left)
- Maniglia con rosette senza bocchette / Lever handle on rose without rose for key
- Coppie impugnature (CM) con grano e ferro senza rosette e senza bocchette / Pair levers (CM) with grub screws and square pin without rose and without rose for key

art. 423 Q-PLUS

design: Marco Pialorsi
materiale: Ottone
material: Solid Brass

Brass Class
100% Ottone

Decorata con cristalli Swarovski®

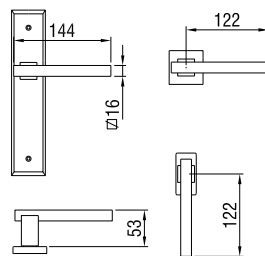

VERSIONI / VERSIONS



Finiture
Finishes

LV/SW3
CR/SW3
SC/SW3

LV/SW7
CR/SW7
SC/SW7

BGO/SW3
SNV/SW3

BGO/SW7
SNV/SW7



MANIGLIA CON PLACCA / LEVER HANDLE ON PLATE

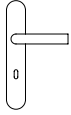

423 MP 130

Maniglia con placca
Lever Handle on plate

130 mm 245x50

con molla e grano
with spring and grub screw

• • • • 1

MANIGLIA SU ROSETTA / LEVER HANDLE ON ROSE



423 MR Q86

Maniglia con rosetta
Lever Handle on rose

Q86 mm 50x50

con molla e grano
with spring and grub screw

• • • • 1

CREMONESE / WINDOW HANDLE WITH MECHANISM



423 SG Q13*

Cremonese con placca
Window Handle on plate

Q13 mm 160X33

coprivite con gioco
with cover-screw plate with mech

• • • • 2

MARTELLINA / WINDOW HANDLE WITHOUT MECHANISM



423 SE Q13*

Martellina con placca
Window Handle on plate

Q13 mm 160X33

coprivite q.7
with cover-screw plate with sq-pin mm7

• • • • 2

DREH KIPP / DREH KIPP



423 DK Q15

Dreh Kipp con rosetta
Dreh Kipp on rose

Q15 mm 65x31

con movimento in metallo
with metal mechanism

• • • • 2

* Placca adatta a movimenti intercambiabili - Plate suitable to interchangeable movements

Per caratteristiche tecniche rosette vedi apposito capitolo soluzioni tecniche e componenti / For technical specifications rosettes see specific section technical solutions and components

A RICHIESTA / ON REQUEST:

- Mezza maniglia con placca o con rosetta (specificare se destra o sinistra) / Half lever handle on plate or on rose (to specify if right or left)
- Maniglia con rosette senza bocchette / Lever handle on rose without rose for key
- Coppie impugnature (CM) con grano e ferro senza rosette e senza bocchette / Pair levers (CM) with grub screws and square pin without rose and without rose for key

art.425 Q-INSERT

design: Studio Reguitti
 materiale: Impugnatura in Zama / legno (Ebano - Wengè)
 material: Zamak / wood (Ebony - Wengè)

TeKnoMetal
 Linea in zama



425 MR Q86 EB/SC



425 MR Q86 EB/CR



425 MR Q86 WE/SC



425 MR Q86 WE/CR

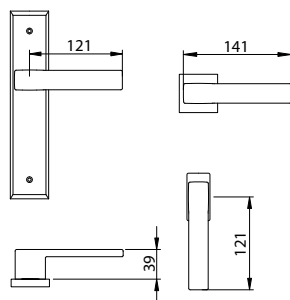

425 DK Q15 EB/SC



425 DK Q15 WE/SC

VERSIONI / VERSIONS



Finiture
 Finishes

MANIGLIA SU PLACCA / LEVER HANDLE ON PLATE

425 MP 130 Maniglia con placca 130 mm 245x50
 Lever Handle on plate

con molla e grano
 with spring and grub screw

EB/SC EB/CR	WE/SC WE/CR	
•	•	1
•	•	1
•	•	2
•	•	2
•	•	2
•	•	2
•	•	1

MANIGLIA SU ROSETTA / LEVER HANDLE ON ROSE

425 MR Q86 Maniglia con rosetta Q86 mm 50x50
 Lever Handle on rose

con molla e grano
 with spring and grub screw

CREMONESE / WINDOW HANDLE WITH MECHANISM

425 SG Q13* Cremonese con placca Q13 mm 160X33
 Window Handle on plate

coprivite con gioco
 with cover-screw plate with mechanism

MARTELLINA / WINDOW HANDLE WITHOUT MECHANISM

425 SE Q13* Martellina con placca Q13 mm 160X33
 Window Handle on plate

coprivite q.7
 with cover-screw plate with square-pin mm 7

DREH KIPP / DREH KIPP

425 DK Q15 Dreh Kipp con rosetta Q15 mm 65x31
 Dreh Kipp on rose

con movimento in metallo
 with metal mechanism

425 DK C70 Dreh Kipp con rosetta C70 mm 69x33

c/chiave, cilindro e movimento in metallo
 with key and cylinder and metal mechanism

* Placca adatta a movimenti intercambiabili
 Plate suitable to interchangeable movements

A RICHIESTA / ON REQUEST:

- Mezza maniglia con placca o con rosetta (specificare se destra o sinistra) / Half lever handle on plate or on rose (to specify if right or left)
- Maniglia con rosette senza bocchette / Lever handle on rose without rose for key
- Coppie impugnature (CM) con grano e ferro senza rosette e senza bocchette / Pair levers (CM) with grub screws and square pin without rose and without rose for key

art. 426 B-ARTE

TeKnoMetal

design: Studio Reguitti
materiale: Impugnatura Zama
material: Lever Zamak

TeKnoMetal
Linea in zama

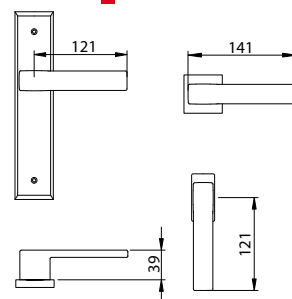

426 MR Q86 ZSC/ZCR



426 SE Q13 ZSC/ZCR
426 SG Q13 ZSC/ZCR



426 DK Q15 ZSC/ZCR

VERSIONI / VERSIONS



Finiture
Finishes

MANIGLIA SU PLACCA / LEVER HANDLE ON PLATE

426 MP 130 Maniglia con placca 130 mm 245x50
Lever Handle on plate

con molla e grano
with spring and grub screw

ZSC/ZCR



1

MANIGLIA SU ROSETTA / LEVER HANDLE ON ROSE

 426 MR Q86 Maniglia con rosetta Q86 mm 50x50
Lever Handle on rose

con molla e grano
with spring and grub screw

ZSC/ZCR

1

CREMONESE / WINDOW HANDLE WITH MECHANISM

426 SG Q13* Cremonese con placca Q13 mm 160X33
Window Handle on plate

coprivite con gioco
with cover-screw plate with mechanism

ZSC/ZCR

2

MARTELLINA / WINDOW HANDLE WITHOUT MECHANISM

426 SE Q13* Martellina con placca Q13 mm 160X33
Window Handle on plate

coprivite q.7
with cover-screw plate with square-pin mm 7

ZSC/ZCR

2

DREH KIPP / DREH KIPP



426 DK Q15 Dreh Kipp con rosetta Q15 mm 65x31
Dreh Kipp on rose

con movimento in metallo
with metal mechanism

ZSC/ZCR

2

426 DK C70 Dreh Kipp con rosetta C70 mm 69x33
Dreh Kipp on rose

c/chiave, cilindro e movimento in metallo
with key and cylinder and metal mechanism

ZSC/ZCR

1

* Placca adatta a movimenti intercambiabili
Plate suitable to interchangeable movements

A RICHIESTA / ON REQUEST:

- Mezza maniglia con placca o con rosetta (specificare se destra o sinistra) / Half lever handle on plate or on rose (to specify if right or left)
- Maniglia con rosette senza bocchette / Lever handle on rose without rose for key
- Coppie impugnature (CM) con grano e ferro senza rosette e senza bocchette / Pair levers (CM) with grub screws and square pin without rose and without rose for key

art. 427 Q-STRASS

design: Studio Reguitti
materiale: Impugnatura Zama
material: Lever Zamak

TeKnoMetal
Linea in zama

ARRICCHITA CON ELEMENTI SWAROVSKI®
WITH SWAROVSKI® ELEMENTS

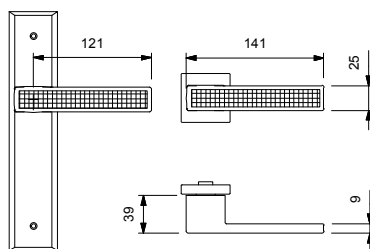

427 MR Q56 - SC/STRASS

Sottorosetta in metallo



427 MR Q56 - OC/STRASS
Sottorosetta in metallo



427 SE Q13 - SC/STRASS
427 SG Q13 - SC/STRASS



427 DK Q15 - SC/STRASS







427 DK Q75 - SC/STRASS





MANIGLIA CON ROSETTA / LEVER HANDLE ON ROSE

€

	 427 MR Q56-71	Maniglia con rosetta Lever handle on rose	Q56 mm 50x50	Base in metallo con molla e bocc. Q08 Internal metal - spring and Q08 key rose	•	1
	 427 MR Q86	Maniglia con rosetta Lever handle on rose	Q86 mm 50x50	con molla with spring	•	1

MANIGLIA CON ROSETTA E NOTT. WC / LEVER HANDLE ON ROSE AND WC TURN

€

	 427 RQ Q56	Maniglia con rosetta Lever handle on rose	Q56 mm 50x50	con molla e noct. wc 124 with spring and wc turn 124	•	1
--	---	--	--------------	---	---	---

MARTELLINA / WINDOW HANDLE WITHOUT MECHANISM

€

	427 SE Q13*	Martellina con placca Martellina on plate	Q13 mm 160x33	coprivite q.7 with cov.scr.plate and sq.-pin mm 7	•	2
	427 SE Q90*	Martellina con placca Martellina on plate	Q90 mm 190x38	coprivite q.7 with cov.scr.plate and sq.-pin mm 7	•	2

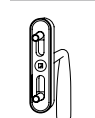

CREMONESE / WINDOW HANDLE WITH MECHANISM

€

	427 SG Q13*	Cremonese con placca Cremon on plate	Q13 mm 160x33	coprivite con gioco with cover-screw plate with mechanism	•	2
	427 SG Q90*	Cremonese con placca Cremon on plate	Q90 mm 190x38	coprivite con gioco with cover-screw plate with mechanism	•	2

DREH KIPP / DREH KIPP

€

	427 DK C70	Dreh kipp con rosetta Safety DK on rose	C70 mm 69x33	con chiave, cilindro e mov. in metallo with key-cylinder and metal mechanism	•	1
	427 DK Q15	Dreh kipp con rosetta Dreh Kipp on rose	Q15 mm 65x31	con movimento in metallo with metal mechanism	•	2
	427 DK Q75	Dreh kipp con rosetta Dreh Kipp on rose	Q75 mm 64x30	con mov. securblock e puls. di sicurezza with securblock system and push button	•	2

Per caratteristiche tecniche rosette vedi apposito capitolo soluzioni tecniche e componenti / For technical specifications rosettes see specific section technical solutions and components

A RICHIESTA / ON REQUEST:

- Mezza maniglia con placca o con rosetta (specificare se destra o sinistra) / Half lever handle on plate or on rose (to specify if right or left)
- Maniglia con rosette senza bocchette / Lever handle on rose without rose for key
- Coppie impugnature (CM) con grano e ferro senza rosette e senza bocchette / Pair levers (CM) with grub screws and square pin without rose and without rose for key

art. 428 B-STRASS

design: Studio Reguitti
materiale: Impugnatura Zama
material: Lever Zamak

TeKnoMetal
Linea in zama

ARRICCHITA CON ELEMENTI SWAROVSKI®
WITH SWAROVSKI® ELEMENTS

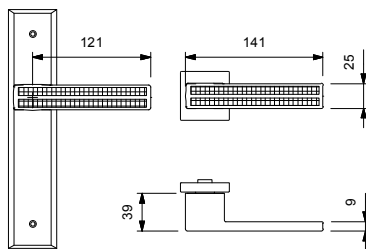

428 MR Q56 - OC/STRASS

Sottorosea in metallo



428 MR Q56 - SC/STRASS

Sottorosea in metallo



428 SE Q90 - SC/STRASS

428 SG Q90 - SC/STRASS



428 DK Q15 - SC/STRASS





428 DK C70 - SC/STRASS



MANIGLIA CON ROSETTA / LEVER HANDLE ON ROSE

	428 MR Q56-71	Maniglia con rosetta Lever handle on rose	Q56 mm 50x50	Base in metallo con molla e bocc. Q08 Internal metal - spring and Q08 key rose
	428 MR Q86	Maniglia con rosetta Lever handle on rose	Q86 mm 50x50	con molla with spring

MANIGLIA CON ROSETTA / LEVER HANDLE



	2 MR Q-1	Maniglia con rosetta Lever handle on rose	Q
	2 MR Q	Maniglia con rosetta Lever handle on rose	Q

MANIGLIA CON ROSETTA E NOTT. WC / LEVER HANDLE ON ROSE AND WC TURN MANIGLIA CON ROSETTA E NOTT. WC / LEVER HANDLE ON ROSE AND WC TURN

	428 RQ Q56	Maniglia con rosetta Lever handle on rose	Q56 mm 50x50	con molla e nott. wc 124 with spring and wc turn 124
--	------------	--	--------------	---

	2 RQ Q	Maniglia con rosetta Lever handle on rose	Q
---	--------	--	---



MARTELLINA / WINDOW HANDLE WITHOUT MECHANISM

	428 SE Q13*	Martellina con placca Martellina on plate	Q13 mm 160x33	coprivite q.7 with cov.scr.plate and sq.-pin mm 7
	428 SE Q90*	Martellina con placca Martellina on plate	Q90 mm 190x38	coprivite q.7 with cov.scr.plate and sq.-pin mm 7



MARTELLINA / WINDOW HANDLE WITHOUT MECHANISM

	2 SE Q13*	Martellina con placca Martellina on plate	Q13
	2 SE Q*	Martellina con placca Martellina on plate	Q



CREMONESE / WINDOW HANDLE WITH MECHANISM

	428 SG Q13*	Cremonese con placca Cremon on plate	Q13 mm 160x33	coprivite con gioco with cover-screw plate with mechanism
	428 SG Q90*	Cremonese con placca Cremon on plate	Q90 mm 190x38	coprivite con gioco with cover-screw plate with mechanism



CREMONESE / WINDOW HANDLE WITH MECHANISM

	2 SG Q13*	Cremonese con placca Cremon on plate	Q13
	2 SG Q*	Cremonese con placca Cremon on plate	Q

DREH KIPP / DREH KIPP

	428 DK C70	Dreh kipp con rosetta Safety DK on rose	C70 mm 69x33	con chiave, cilindro e mov. in metallo with key-cylinder and metal mechanism
	428 DK Q15	Dreh kipp con rosetta Dreh Kipp on rose	Q15 mm 65x31	con movimento in metallo with metal mechanism
	428 DK Q75	Dreh kipp con rosetta Dreh Kipp on rose	Q75 mm 64x30	con mov. securblock e puls. di sicurezza with securblock system and push button

DREH KIPP / DREH KIPP

	2 DK C	Dreh kipp con rosetta Safety DK on rose	C
	2 DK Q1	Dreh kipp con rosetta Dreh Kipp on rose	Q1
	2 DK Q	Dreh kipp con rosetta Dreh Kipp on rose	Q

Per caratteristiche tecniche rosette vedi apposito capitolo soluzioni tecniche e componenti / For technical specifications rosettes see specific section technical solutions and components

A RICHIESTA / ON REQUEST:

- Mezza maniglia con placca o con rosetta (specificare se destra o sinistra) / Half lever handle on plate or on rose (to specify if right or left)
- Maniglia con rosette senza bocchette / Lever handle on rose without rose for key
- Coppie impugnature (CM) con grano e ferro senza rosette e senza bocchette / Pair levers (CM) with grub screws and square pin without rose and without rose for key

art. 429 Q-STAR

design: St. Reguitti - Mod. Dep.
materiale: Ottone
material: Solid Brass

Brass Class
100% Ottone

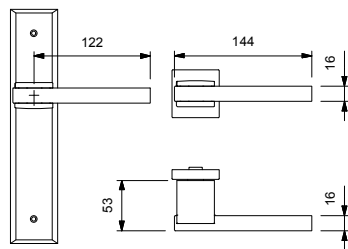

429 MR Q86 - OC



429 RQ Q56 - OSC/OC



429 MR Q56 - OSC/OC
Sottorosetta in metallo



429 SE Q90 - OC
429 SG Q90 - OC



429 DK Q15 - OSC







429 DK Q75 - OSC

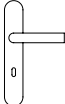



MANIGLIA CON PLACCA / LEVER HANDLE ON PLATE

				€	
	429 MP 130	Maniglia con placca Lever handle on plate	130 mm 245x50 con molla with spring	•	1

MANIGLIA CON ROSETTA / LEVER HANDLE ON ROSE

				€	
	429 MR 199-71	Maniglia con rosetta Lever handle on rose	199 mm 50x50 RPM system c/molla e bocc.Q08 RPM system with spring and Q08 ros.for key	•	1
	429 MR Q46	Maniglia con rosetta Lever handle on rose	Q46 mm 45x45 con molla with spring	•	1
	429 MR Q56-71	Maniglia con rosetta Lever handle on rose	Q56 mm 50x50 Base in metallo con molla e bocc. Q08 Internal metal - spring and Q08 key rose	•	1
	429 MR Q86	Maniglia con rosetta Lever handle on rose	Q86 mm 50x50 con molla with spring	•	1

MANIGLIA CON ROSETTA E NOTT. WC / LEVER HANDLE ON ROSE AND WC TURN

	429 RQ Q56	Maniglia con rosetta Lever handle on rose	Q56 mm 50x50 con molla e nott. wc 124 with spring and wc turn 124	•	
	429 RQ Q86	Maniglia con rosetta Lever handle on rose	Q86 mm 50x50 con molla e nott. wc 124 with spring and wc turn 124	•	

MARTELLINA / WINDOW HANDLE WITHOUT MECHANISM

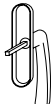
				€	
	429 SE Q13*	Martellina con placca Martellina on plate	Q13 mm 160x33 coprivate q.7 with cov.scr.plate and sq.-pin mm 7	•	2
	429 SE Q90*	Martellina con placca Martellina on plate	Q90 mm 190x38 coprivate q.7 with cov.scr.plate and sq.-pin mm 7	•	2

CREMONESE / WINDOW HANDLE WITH MECHANISM

				€	
	429 SG Q13*	Cremonese con placca Cremon on plate	Q13 mm 160x33 coprivate con gioco with cover-screw plate with mechanism	•	2
	429 SG Q90*	Cremonese con placca Cremon on plate	Q90 mm 190x38 coprivate con gioco with cover-screw plate with mechanism	•	2

DREH KIPP / DREH KIPP

				€	
	429 DK Q15	Dreh kipp con rosetta Dreh Kipp on rose	Q15 mm 65x31 con movimento in metallo with metal mechanism	•	2
	429 DK Q75	Dreh kipp con rosetta Dreh Kipp on rose	Q75 mm 64x30 con mov. securblock e puls. di sicurezza with securblock system and push button	•	2

* Placca adatta a movimenti intercambiabili - Plate suitable to interchangeable movements

Per caratteristiche tecniche rosette vedi apposito capitolo soluzioni tecniche e componenti / For technical specifications rosettes see specific section technical solutions and components

A RICHIESTA / ON REQUEST:

- Mezza maniglia con placca o con rosetta (specificare se destra o sinistra) / Half lever handle on plate or on rose (to specify if right or left)
- Maniglia con rosette senza bocchette / Lever handle on rose without rose for key
- Coppie impugnature (CM) con grano e ferro senza rosette e senza bocchette / Pair levers (CM) with grub screws and square pin without rose and without rose for key

art. 429 Q-STAR

design: St. Reguitti - Mod. Dep.
materiale: Ottone
material: Solid Brass

ARRICCHITA CON ELEMENTI SWAROVSKI®
WITH SWAROVSKI® ELEMENTS

Brass Class
100% Ottone

429 MR Q86 - CR/SW3

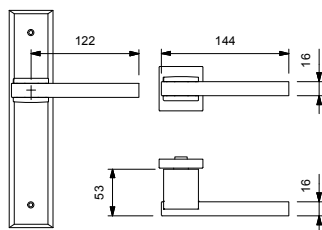

429 MR Q86 - CR/SW3



429 MR Q86 - CR/SW7



429 DK Q15 - SC/SW7



429 DK Q75 - SC/SW3



429 SE Q13 - CR/SW3
429 SG Q13 - CR/SW3

VERSIONI / VERSIONS



VERSIONI / VERSIONS		CR/SW7 SC/SW7	BGO/SW3	CR/SW3 SC/SW3	
MANIGLIA CON PLACCA / LEVER HANDLE ON PLATE					
	429 MP 130	Maniglia con placca Lever handle on plate	130 mm 245x50	con molla with spring	• • • 1
MANIGLIA CON ROSETTA / LEVER HANDLE ON ROSE					
	429 MR Q86	Maniglia con rosetta Lever handle on rose	Q86 mm 50x50	con molla with spring	• • • 1
MARTELLINA / WINDOW HANDLE WITHOUT MECHANISM					
	429 SE Q13*	Martellina con placca Martellina on plate	Q13 mm 160x33	coprivite q.7 with cov.scr.plate and sq.-pin mm 7	• • • 2
CREMONESE / WINDOW HANDLE WITH MECHANISM					
	429 SG Q13*	Cremonese con placca Cremon on plate	Q13 mm 160x33	coprivite con gioco with cover-screw plate with mechanism	• • • 2
DREH KIPP / DREH KIPP					
	429 DK C70	Dreh kipp con rosetta Safety DK on rose	C70 mm 69x33	con chiave, cilindro e mov. in metallo with key-cylinder and metal mechanism	• • • 1
	429 DK Q15	Dreh kipp con rosetta Dreh Kipp on rose	Q15 mm 65x31	con movimento in metallo with metal mechanism	• • • 2
	429 DK Q75	Dreh Kipp destro con rosetta Dreh Kipp (right) on rose	Q75 mm 64x30	con mov. securblock e puls. di sicurezza with securblock system and push button	• • • 2

A RICHIESTA / ON REQUEST:

- Mezza maniglia con placca o con rosetta (specificare se destra o sinistra) / Half lever handle on plate or on rose (to specify if right or left)
- Maniglia con rosette senza bocchette / Lever handle on rose without rose for key
- Coppie impugnature (CM) con grano e ferro senza rosette e senza bocchette / Pair levers (CM) with grub screws and square pin without rose and without rose for key

art. 432 XL.Q-ARTE

design: Studio Reguitti
 materiale: Ottone
 material: Solid Brass

Brass Class
 100% Ottone

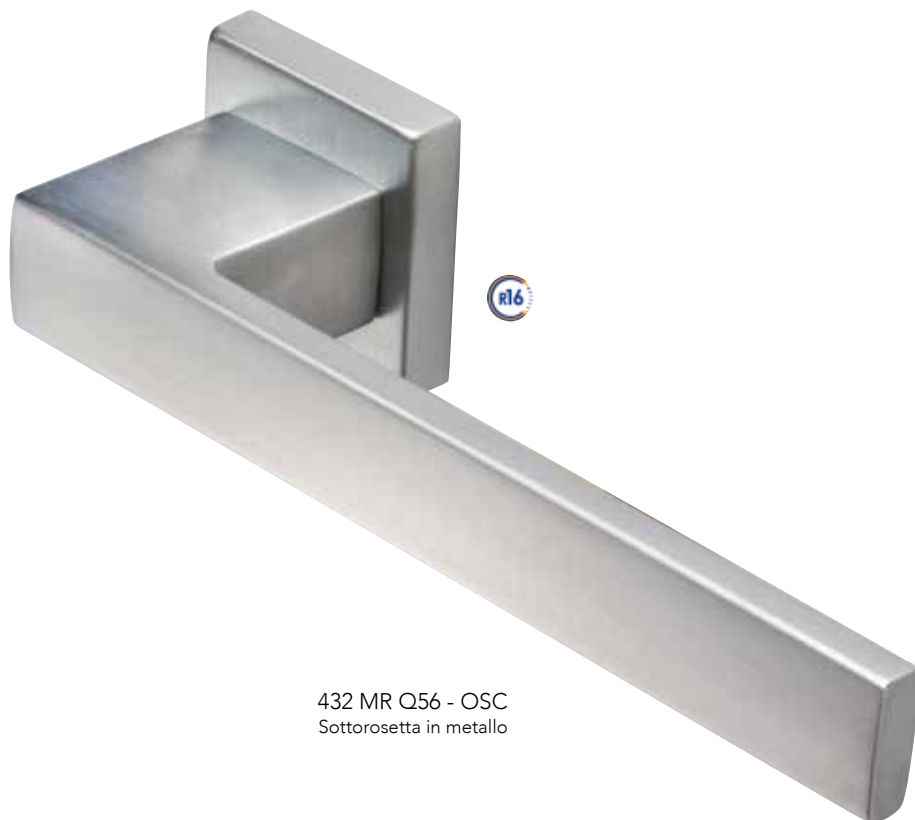
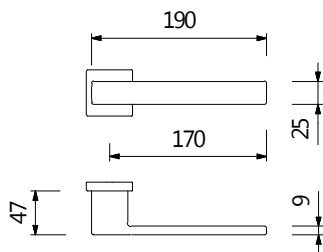

432 MR Q56 - OSC
 Sottorosetta in metallo



VERSIONI / VERSIONS





Finiture
 Finishes

OC
 OSC



MANIGLIA CON ROSETTA / LEVER HANDLE ON ROSE

				€	
	432 MR 199-71	Maniglia con rosetta Lever handle on rose	199 mm 50x50	RPM system c/molla e bocc. Q08 RPM system with spring and Q08 ros. for key	• 1
	432 MR Q56-71	Maniglia con rosetta Lever handle on rose	Q56 mm 50x50	Base in metallo con molla e bocc. Q08 Internal metal - spring and Q08 key rose	• 1
	432 MR Q86	Maniglia con rosetta Lever handle on rose	Q86 mm 50x50	con molla with spring	• 1

Per caratteristiche tecniche rosette vedi apposito capitolo soluzioni tecniche e componenti / For technical specifications rosettes see specific section technical solutions and components

art. 434 XL.B-ARTE

design: Studio Reguitti
 materiale: Ottone
 material: Solid Brass

Brass Class
 100% Ottone

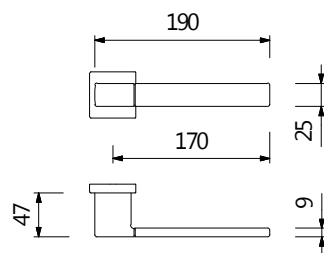

434 MR Q56 - OSC/OC
 Sottorosetta in metallo



VERSIONI / VERSIONS





Finiture
 Finishes

OSC/OC



MANIGLIA CON ROSETTA / LEVER HANDLE ON ROSE

				€	
	434 MR 199-71	Maniglia con rosetta Lever handle on rose	199 mm 50x50	RPM system c/molla e bocc.Q08 RPM system with spring and Q08 ros.for key	• 1
	434 MR Q56-71	Maniglia con rosetta Lever handle on rose	Q56 mm 50x50	Base in metallo con molla e bocc. Q08 Internal metal - spring and Q08 key rose	• 1
	434 MR Q86	Maniglia con rosetta Lever handle on rose	Q86 mm 50x50	con molla with spring	• 1

Per caratteristiche tecniche rosette vedi apposito capitolo soluzioni tecniche e componenti / For technical specifications rosettes see specific section technical solutions and components

art. 436 XL.Q-STAR

design: Studio Reguitti
 materiale: Ottone
 material: Solid Brass

Brass Class
 100% Ottone

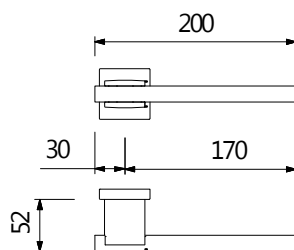

436 MR Q56 - OSC
 Sottorosetta in metallo

VERSIONI / VERSIONS





Finiture
 Finishes

OC
 OSC



MANIGLIA CON ROSETTA / LEVER HANDLE ON ROSE

				€	
	436 MR 199-71	Maniglia con rosetta Lever handle on rose	199 mm 50x50	RPM system c/molla e bocc. Q08 RPM system with spring and Q08 ros. for key	• 1
	436 MR Q56-71	Maniglia con rosetta Lever handle on rose	Q56 mm 50x50	Base in metallo con molla e bocc. Q08 Internal metal - spring and Q08 key rose	• 1
	436 MR Q86	Maniglia con rosetta Lever handle on rose	Q86 mm 50x50	con molla with spring	• 1

Per caratteristiche tecniche rosette vedi apposito capitolo soluzioni tecniche e componenti / For technical specifications rosettes see specific section technical solutions and components

art. **800** EPOCA

design: Studio Reguitti
 materiale: Ottone
 material: Solid Brass

Brass Class
 100% Ottone

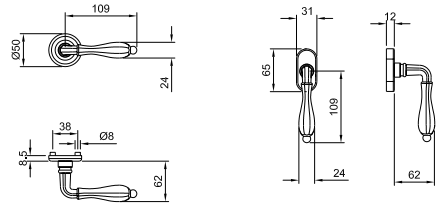

800 MR 006 AGV



800 MR 004 AGV



800 MR 006 AN



800 MR 006 VBN



800 MR 006 RX



800 MR 006 BR.UN



800 MP 039 AGV



800 DK 015 AGV



800 DK 015 VBN



MANIGLIA CON PLACCA / LEVER HANDLE ON PLATE

	800 MP 039	Maniglia con placca Lever Handle on plate	039	mm 255x50	con molla e grano with spring and grub screw	•	•	•	•	1
	800 MP 040	Maniglia con placca Lever Handle on plate	040	mm 244x40	con molla e grano with spring and grub screw	•	•	•	•	1
	800 MP 026	Maniglia con placca Lever Handle on plate	026	mm 225x26	con grano with grub screw	•	•	•	•	1

MANIGLIA CON ROSETTA / LEVER HANDLE ON ROSE

	800 MR 004	Maniglia con rosetta Lever Handle on rose	004	mm Ø45x9	con molla e grano with spring and grub screw	•	•	•	•	1
	800 MR 006	Maniglia con rosetta Lever Handle on rose	006	mm Ø50x8	tipo lusso con molla e grano lusso type with spring and grub screw	•	•	•	•	1
	800 MR 011	Maniglia con rosetta Lever Handle on rose	011	mm Ø50x8	tipo lusso con molla e grano lusso type with spring and grub screw	•	•	•	2.	1
	800 MR 416	Maniglia con rosetta Lever Handle on rose	416	mm Ø45x9	con molla e grano with spring and grub screw			•	•	1
	800 MR 916	Maniglia con rosetta Lever Handle on rose	916	mm 62x32	ovale c/molla ambidestra bidirezionale oval with bidirectional returning spring	•	•	•	•	1

CREMONESE / WINDOW HANDLE WITH MECHANISM

	800 SG 040	Cremonese con placca Window Handle on plate	040	mm 174x37	con gioco with mechanism	•	•	•	•	2
--	------------	--	-----	-----------	-----------------------------	---	---	---	---	---

MARTELLINA / WINDOW HANDLE WITHOUT MECHANISM

	800 SE 040	Martellina con placca Window Handle on plate	040	mm 174x37	q.7 without mechanism with square-pin mm 7	•	•	•	•	2
--	------------	---	-----	-----------	---	---	---	---	---	---

DREH KIPP / DREH KIPP

	800 DK 015	Dreh Kipp con rosetta Dreh Kipp on rose	015	mm 65x31	con movimento in metallo with metal mechanism	•	•	•	•	3
	800 DK 014	Dreh Kipp con rosetta Dreh Kipp on rose	014	mm 80x35		•	•	•	•	3
	800 DK C67	Dreh Kipp con rosetta Safety DK on rose	C67	mm 69x33	c/chiave e cilindro e movimento in metallo with key and cylinder and metal mechanism	•	•	•	•	1



800 DK C67 AN



800 MR 916 AN



800 DK 014 AGV



800 MR 011 AN



Per caratteristiche tecniche rosette vedi apposito capitolo soluzioni tecniche e componenti / For technical specifications rosettes see specific section technical solutions and components

A RICHIESTA / ON REQUEST:

- Mezza maniglia con placca o con rosetta (specificare se destra o sinistra) / Half lever handle on plate or on rose (to specify if right or left)
- Maniglia con rosette senza bocchette / Lever handle on rose without rose for key
- Coppie impugnature (CM) con grano e ferro senza rosette e senza bocchette / Pair levers (CM) with grub screws and square pin without rose and without rose for key

art. 900 CHARME

design: Studio Reguitti
 materiale: Ottone
 material: Solid Brass

Brass Class
 100% Ottone

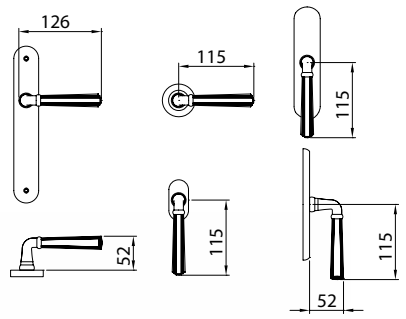

900 MR 006 AN



900 MR 004 AN



900 MR 006 AGV



900 MR 006 VBN



900 MR 006 RX



900 MR 006 BR.UN



900 MP 040 AN



900 DK 015 VBN



900 DK 015 AN



						AN	AGV BR.UN	LV LR VBN	RX	
MANIGLIA CON PLACCA / LEVER HANDLE ON PLATE										
	900 MP 039	Maniglia con placca Lever Handle on plate	039	mm 255x50	con molla e grano with spring and grub screw	•	•	•	•	1
	900 MP 040	Maniglia con placca Lever Handle on plate	040	mm 244x40	con molla e grano with spring and grub screw	•	•	•	•	1
	900 MP 026	Maniglia con placca Lever Handle on plate	026	mm 225x26	con grano with grub screw	•	•	•	•	1
MANIGLIA CON ROSETTA / LEVER HANDLE ON ROSE										
	900 MR 004	Maniglia con rosetta Lever Handle on rose	004	mm Ø45x9	con molla e grano with spring and grub screw	•	•	•	•	1
	900 MR 006	Maniglia con rosetta Lever Handle on rose	006	mm Ø50x8	tipo lusso con molla e grano lusso type with spring and grub screw	•	•	•	•	1
	900 MR 011	Maniglia con rosetta Lever Handle on rose	011	mm Ø50x8	tipo lusso con molla e grano lusso type with spring and grub screw	•	•	•	•	1
	900 MR 416	Maniglia con rosetta Lever Handle on rose	416	mm Ø45x9	con molla e grano with spring and grub screw			•	•	1
	900 MR 916	Maniglia con rosetta Lever Handle on rose	916	mm 62x32	ovale c/molla ambidestra bidirezionale oval with bidirectional returning spring	•	•	•	•	1
CREMONESE / WINDOW HANDLE WITH MECHANISM										
	900 SG 040	Cremonese con placca Window Handle on plate	040	mm 174x37	con gioco with mechanism	•	•	•	•	2
MARTELLINA / WINDOW HANDLE WITHOUT MECHANISM										
	900 SE 040	Martellina con placca Window Handle on plate	040	mm 174x37 q.7	without mechanism with square-pin mm 7	•	•	•	•	2
DREH KIPP / DREH KIPP										
	900 DK 015	Dreh Kipp con rosetta Dreh Kipp on rose	015	mm 65x31	con movimento in metallo with metal mechanism	•	•	•	•	3
	900 DK 014	Dreh Kipp con rosetta Dreh Kipp on rose	014	mm 80x35		•	•	•	•	3
	900 DK C67	Dreh Kipp con rosetta Safety DK on rose	C67	mm 69x33	c/chiave e cilindro e movimento in metallo with key and cylinder and metal mechanism	•	•	•	•	1



900 DK C67 AGV



900 MR 916 AN



900 DK 014 AN



900 MR 011 AGV

Per caratteristiche tecniche rosette vedi apposito capitolo soluzioni tecniche e componenti / For technical specifications rosettes see specific section technical solutions and components

A RICHIESTA / ON REQUEST:

- Mezza maniglia con placca o con rosetta (specificare se destra o sinistra) / Half lever handle on plate or on rose (to specify if right or left)
- Maniglia con rosette senza bocchette / Lever handle on rose without rose for key
- Coppie impugnature (CM) con grano e ferro senza rosette e senza bocchette / Pair levers (CM) with grub screws and square pin without rose and without rose for key

art. J15 GOLF

design: Studio Reguitti
 materiale: Impugnatura Zama
 material: Lever Zamak

TeKnoMetal
 Linea in zama

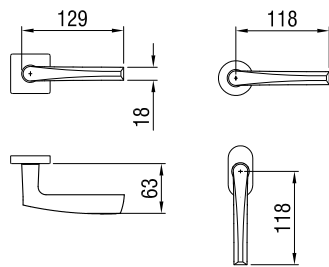

J15 MR Q86 SNV



J15 SE Q13 ZSC
 J15 SG Q13 ZSC



J15 MR 816 ZSC



J15 MR 416 SNV



J15 MR 9Q6 ZSC



J15 DK C67 ZSC



J15 DK C70 ZSC











J15 DK Q15 SNV





J15 DK 015 ZSC





MANIGLIA SU ROSETTA / LEVER HANDLE ON ROSE

	 J15 MR 416	Maniglia con rosetta Lever Handle on rose	416 mm Ø45X9	con molla e grano with spring and grub screw	•	•	1
	 J15 MR 816	Maniglia con rosetta Lever Handle on rose	816 mm Ø50x10	con molla e grano with spring and grub screw	•	•	1
	 J15 MR 9Q6	Maniglia con rosetta Lever Handle on rose	9Q6 mm 62x32	con molla e grano with spring and grub screw	•	•	1
	 J15 MR Q86	Maniglia con rosetta Lever Handle on rose	Q86 mm 50x50	con molla e grano with spring and grub screw	•	•	1



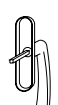

CREMONESE / WINDOW HANDLE WITH MECHANISM

	J15 SG Q13*	Cremonese con placca Window Handle on plate	Q13 mm 160X33	coprivite con gioco with cover-screw plate with mechanism	•	•	2
	J15 SG 070*	Cremonese con placca Window Handle on plate	070 mm 189x36	coprivite con gioco with cover-screw plate with mechanism	•	•	2

MARTELLINA / WINDOW HANDLE WITHOUT MECHANISM

	J15 SE Q13*	Martellina con placca Window Handle on plate	Q13 mm 160x33	coprivite q.7 with cover-screw plate with square-pin mm 7	•	•	2
	J15 SE 070*	Martellina con placca Window Handle on plate	070 mm 189x36	coprivite q.7 with cover-screw plate with square-pin mm 7	•	•	2

DREH KIPP / DREH KIPP

	J15 DK 015	Dreh Kipp con rosetta Dreh Kipp on rose	015 mm 65x31	con movimento in metallo with metal mechanism	•	•	3
	J15 DK Q15	Dreh Kipp con rosetta Dreh Kipp on rose	Q15 mm 65x31	con movimento in metallo with metal mechanism	•	•	3
	J15 DK C70	Dreh Kipp con rosetta Dreh Kipp on rose	C70 mm 69x33	c/chiave, cilindro e movimento in metallo with key and cylinder and metal mechanism	•	•	1
	J15 DK C67	Dreh Kipp con rosetta Dreh Kipp on rose	C67 mm 69x33	c/chiave, cilindro e movimento in metallo with key and cylinder and metal mechanism	•	•	1

* Placca adatta a movimenti intercambiabili
Plate suitable to interchangeable movements

Per caratteristiche tecniche rosette vedi apposito capitolo soluzioni tecniche e componenti / For technical specifications rosettes see specific section technical solutions and components

A RICHIESTA / ON REQUEST:

- Mezza maniglia con placca o con rosetta (specificare se destra o sinistra) / Half lever handle on plate or on rose (to specify if right or left)
- Maniglia con rosette senza bocchette / Lever handle on rose without rose for key
- Coppie impugnature (CM) con grano e ferro senza rosette e senza bocchette / Pair levers (CM) with grub screws and square pin without rose and without rose for key

art. J40 IXIA

design: Studio Reguitti
materiale: Impugnatura Zama
material: Lever Zamak

TeKnoMetal
Linea in zama

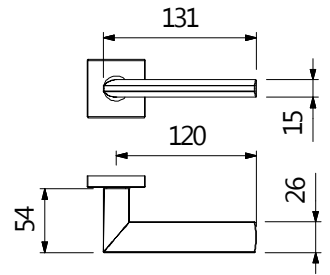

J40 MR Q86 - PSB



J40 MR 9Q6 - ZSC



J40 MR 006 - ZSC



J40 DK Q15 - ZSC







J40 DK 015 - ZSC



J40 DK 015 - PSB



MANIGLIA CON ROSETTA / LEVER HANDLE ON ROSE

				€	€	€	
	J40 MR 006	Maniglia con rosetta Lever handle on rose	006 mm Ø50x8	tipo lusso con molla lusso type with spring	•	•	• 1
	J40 MR 416	Maniglia con rosetta Lever handle on rose	416 mm Ø45x9	con molla with spring	•	•	• 1
	J40 MR 816	Maniglia con rosetta Lever handle on rose	816 mm Ø50x9	con molla with spring	•	•	• 1
	J40 MR 916	Maniglia con rosetta Lever handle on rose	916 mm 62x32	ovale con molla oval with spring	•	•	• 1
	J40 MR 9Q6	Maniglia con rosetta Lever handle on rose	9Q6 mm 61x31	con molla with spring	•	•	• 1
	J40 MR Q86	Maniglia con rosetta Lever handle on rose	Q86 mm 50x50	con molla with spring	•	•	• 1

DREH KIPP / DREH KIPP

					€	€	€	
	J40 DK 015	Dreh kipp con rosetta Dreh Kipp on rose	015 mm 65x31	con movimento in metallo with metal mechanism	•	•	• 3	
	J40 DK Q15	Dreh kipp con rosetta Dreh Kipp on rose	Q15 mm 65x31	con movimento in metallo with metal mechanism	•	•	• 3	
	J40 DK 075	Dreh kipp con rosetta Dreh Kipp on rose	075 mm 64x30	con mov. securblock e puls. di sicurezza with securblock system and push button	•	•	• 2	
	J40 DK Q75	Dreh kipp con rosetta Dreh Kipp on rose	Q75 mm 64x30	con mov. securblock e puls. di sicurezza with securblock system and push button	•	•	• 2	



J40 DK Q75 - ZSC



J40 DK 075 - ZSC

Per caratteristiche tecniche rosette vedi apposito capitolo soluzioni tecniche e componenti / For technical specifications rosettes see specific section technical solutions and components

A RICHIESTA / ON REQUEST:

- Mezza maniglia con placca o con rosetta (specificare se destra o sinistra) / Half lever handle on plate or on rose (to specify if right or left)
- Maniglia con rosette senza bocchette / Lever handle on rose without rose for key
- Coppie impugnature (CM) con grano e ferro senza rosette e senza bocchette / Pair levers (CM) with grub screws and square pin without rose and without rose for key

art. B26 B-MINI26

design: St. Reguitti - Mod. Dep.
materiale: Impugnatura Zama
material: Lever Zamak

TeKnoMetal
Linea in zama

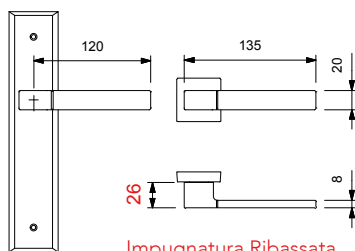

Impugnatura Ribassata
Reduced Size Lever



B26 MR Q46 - ZSC/ZCR



B26 MR Q86 - ZSC/ZCR



B26 DK Q15 - ZSC/ZCR

VERSIONI / VERSIONS



ZSC/ZCR

MANIGLIA CON ROSETTA / LEVER HANDLE ON ROSE				€	
	B26 MR 9Q6	Maniglia con rosetta Lever handle on rose	9Q6 mm 61x31 con molla with spring	•	1
	B26 MR Q46	Maniglia con rosetta Lever handle on rose	Q46 mm 45x45 con molla with spring	•	1
	B26 MR Q86	Maniglia con rosetta Lever handle on rose	Q86 mm 50x50 con molla with spring	•	1
MARTELLINA / WINDOW HANDLE WITHOUT MECHANISM				€	
	B26 SE Q13*	Martellina con placca Martellina on plate	Q13 mm 160x33 coprivite q.7 with cov.scr.plate and sq.-pin mm 7	•	2
	B26 SE Q90*	Martellina con placca Martellina on plate	Q90 mm 190x38 coprivite q.7 with cov.scr.plate and sq.-pin mm 7	•	2
CREMONESE / WINDOW HANDLE WITH MECHANISM				€	
	B26 SG Q13*	Cremonese con placca Cremon on plate	Q13 mm 160x33 coprivite con gioco with cover-screw plate with mechanism	•	2
	B26 SG Q90*	Cremonese con placca Cremon on plate	Q90 mm 190x38 coprivite con gioco with cover-screw plate with mechanism	•	2
DREH KIPP / DREH KIPP				€	
	B26 DK Q15	Dreh kipp con rosetta Dreh Kipp on rose	Q15 mm 65x31 con movimento in metallo with metal mechanism	•	3

* Placca adatta a movimenti intercambiabili / Plate suitable to interchangeable movements

Per caratteristiche tecniche rosette vedi apposito capitolo soluzioni tecniche e componenti / For technical specifications rosettes see specific section technical solutions and components

art. Q26 Q-MINI26

design: St. Reguitti - Mod. Dep.
materiale: Impugnatura Zama
material: Lever Zamak

TeKnoMetal
Linea in zama

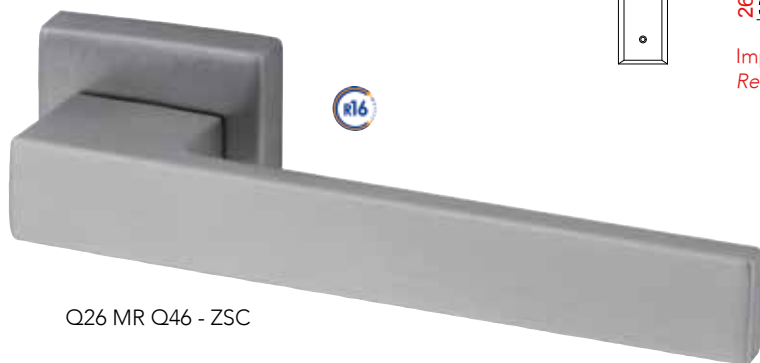
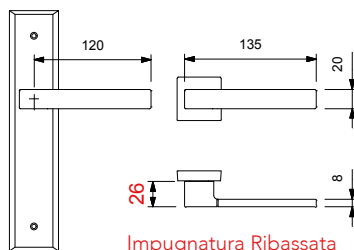

Q26 MR Q46 - ZSC



Q26 MR Q86 - ZSC



Q26 DK Q15 - ZSC

VERSIONI / VERSIONS



Finire
Finishes

ZCR
ZSC

SNV



MANIGLIA CON ROSETTA / LEVER HANDLE ON ROSE

				€	€	
	Q26 MR 9Q6	Maniglia con rosetta Lever handle on rose	9Q6 mm 61x31	con molla with spring	•	• 1
	Q26 MR Q46	Maniglia con rosetta Lever handle on rose	Q46 mm 45x45	con molla with spring	•	• 1
	Q26 MR Q86	Maniglia con rosetta Lever handle on rose	Q86 mm 50x50	con molla with spring	•	• 1

MARTELLINA / WINDOW HANDLE WITHOUT MECHANISM

					€	€	
	Q26 SE Q13*	Martellina con placca Martellina on plate	Q13 mm 160x33	coprivite q.7 with cov.scr.plate and sq.-pin mm 7	•	•	2
	Q26 SE Q90*	Martellina con placca Martellina on plate	Q90 mm 190x38	coprivite q.7 with cov.scr.plate and sq.-pin mm 7	•	•	2

CREMONESE / WINDOW HANDLE WITH MECHANISM

					€	€	
	Q26 SG Q13*	Cremonese con placca Cremon on plate	Q13 mm 160x33	coprivite con gioco with cover-screw plate with mechanism	•	•	2
	Q26 SG Q90*	Cremonese con placca Cremon on plate	Q90 mm 190x38	coprivite con gioco with cover-screw plate with mechanism	•	•	2

DREH KIPP / DREH KIPP

					€	€	
	Q26 DK Q15	Dreh kipp con rosetta Dreh Kipp on rose	Q15 mm 65x31	con movimento in metallo with metal mechanism	•	•	3

* Placca adatta a movimenti intercambiabili / Plate suitable to interchangeable movements

Per caratteristiche tecniche rosette vedi apposito capitolo soluzioni tecniche e componenti / For technical specifications rosettes see specific section technical solutions and components

art. T33 MIGNON

design: Studio Reguitti
 materiale: Ottone
 material: Solid Brass

Brass Class
 100% Ottone

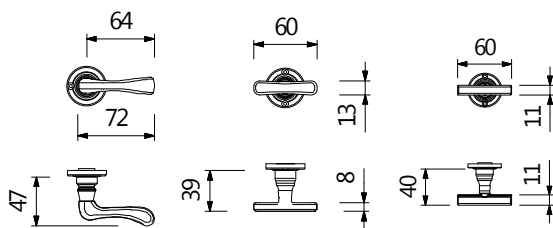

T33 MR T33 - LV



T33 MM T33 - LR



T33 MR T33 - AGV



T33 MR 007 - AN



T33 SP 007 - AGV



T33 DK 015 - LV



T33 TK 015 - VBN



MANIGLIA CON ROSETTA / LEVER HANDLE ON ROSE

					€	€	€	€	€	€	€	
	T33 MR 007	Maniglia con rosetta Lever handle on rose	007	mm 67x27	ovale stretta oval and reduced	•	•	•	•	•	•	2
	T33 MR T33	Maniglia con rosetta Lever handle on rose	T33	mm Ø37x5	con bordo with edge	•	•	•	•	•	•	2

MARTELLINA / WINDOW HANDLE WITHOUT MECHANISM

						€	€	€	€	€	€	
	T33 MA 007	Martellina su rosetta Martellina on rose	007	mm 67x27	q.7 with square-pin mm 7	•	•	•	•	•	•	2
	T33 MA T33	Martellina su rosetta Martellina on rose	T33	mm Ø37x5	q.7 with square-pin mm 7	•	•	•	•	•	•	2

MANIGLIA / MARTELLINA / HANDLE / MARTELLINA

						€	€	€	€	€	€	
	T33 MM T33	Maniglia con rosetta Handle on rose	T33	mm Ø37x5	e impugnatura martellina a "T" "T" shape	•	•	•	•	•	•	1

SEGRETINO PICCOLO / SMALL HANDLE

						€	€	€	€	€	€	
	T33 SP 007	Segretino con rosetta Small handle on rose	007	mm 67x27	q.7 square spindle q. 7	•	•	•	•	•	•	12

COPPIA MARTELLINA / COPPIA MARTELLINA

						€	€	€	€	€	€	
	T33 CB 007	Coppia mart. con ros. Pair window handles on rose	007	q.8	senza bocchette without key rose	•	•	•	•	•	•	2
	T33 CB T33	Coppia mart. con ros. Pair window handles on rose	T33	q.8	senza bocchette without key rose	•	•	•	•	•	•	2

DREH KIPP / DREH KIPP

						€	€	€	€	€	€	
	T33 DK 015	Dreh kipp con rosetta Dreh Kipp on rose	015	mm 65x31	con movimento in metallo with metal mechanism	•	•	•	•	•	•	3

DREH KIPP TK / TK DREH KIPP

						€	€	€	€	€	€	
	T33 TK 015	Dreh kipp con rosetta Dreh Kipp on rose	015	mm 65x31	con impugnatura martellina a "T" "T" shape	•	•	•	•	•	•	3

Per caratteristiche tecniche rosette vedi apposito capitolo soluzioni tecniche e componenti / For technical specifications rosettes see specific section technical solutions and components

A RICHIESTA / ON REQUEST:

- Mezza maniglia con placca o con rosetta (specificare se destra o sinistra) / Half lever handle on plate or on rose (to specify if right or left)
- Maniglia con rosette senza bocchette / Lever handle on rose without rose for key
- Coppie impugnature (CM) con grano e ferro senza rosette e senza bocchette / Pair levers (CM) with grub screws and square pin without rose and without rose for key

art. T36 TUSCANIA

design: Studio Reguitti
 materiale: Ottone
 material: Solid Brass

Brass Class
 100% Ottone

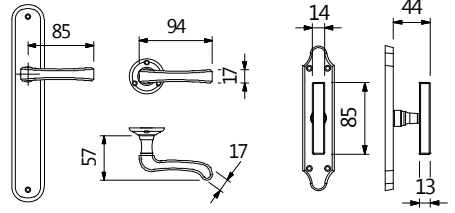

T36 MR T36 - LV



T36 MR T36 - OC



T36 MR 006 - BGO



T36 MR 009 - AN



T36 MR 007 - AGV



T36 MR 416 - VBN



T36 CR 040 - LV
 T36 MA 040 - LV



T36 MP 166 - LV



T36 MP 026 - AN



T36 DK 015 - AGV





T36 DK 075 - AGV

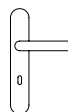

MANIGLIA CON PLACCA / LEVER HANDLE ON PLATE

			€	€	€	€	€					
	T36 MP 026	Maniglia con placca Lever handle on plate	026	mm 225x26	"stretta" "reduced"	•	•	•	•	•	•	1
	T36 MP 166	Maniglia con placca Lever handle on plate	166	mm 242x33	con molla with spring	•	•	•	•	•	•	1

MANIGLIA CON ROSETTA / LEVER HANDLE ON ROSE

			€	€	€	€	€	€				
	T36 MR 006	Maniglia con rosetta Lever handle on rose	006	mm Ø50x8	tipo lusso con molla lusso type with spring	•	•	•	•	•	•	1
	T36 MR 007	Maniglia con rosetta Lever handle on rose	007	mm 67x27	ovale stretta oval and reduced	•	•	•	•	•	•	2
	T36 MR 009	Maniglia con rosetta Lever handle on rose	009	mm 62x32	ovale con molla oval with spring	•	•	•	•	•	•	1
	T36 MR 202	Maniglia con rosetta Lever handle on rose	202	mm Ø52x9	con bordo with edge	•	•	•	•	•	•	2
	T36 MR 416	Maniglia con rosetta Lever handle on rose	416	mm Ø45x9	con molla with spring	•	•	•	•	•	•	1
	T36 MR T36	Maniglia con rosetta Lever handle on rose	T36	mm Ø45x9	con bordo with edge	•	•	•	•	•	•	2

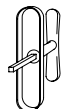

MARTELLINA / WINDOW HANDLE WITHOUT MECHANISM

			€	€	€	€	€					
	T36 MA 040*	Martellina su placca Martellina on plate	040	mm 174x37	q.7 with square-pin mm 7	•	•	•	•	•	•	2
	T36 MA T36	Martellina su rosetta Martellina on rose	T36	mm Ø40	q.7 with square-pin mm 7	•	•	•	•	•	•	2

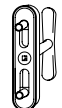
CREMONESE / WINDOW HANDLE WITH MECHANISM

			€	€	€	€	€					
	T36 CR 040*	Cremonese con placca Cremon on plate	040	mm 174x37	con gioco with mechanism	•	•	•	•	•	•	2

DREH KIPP / DREH KIPP

			€	€	€	€	€	€				
	T36 DK 015	Dreh kipp con rosetta Dreh Kipp on rose	015	mm 65x31	con movimento in metallo with metal mechanism	•	•	•	•	•	•	3
	T36 DK 075	Dreh kipp con rosetta Dreh Kipp on rose	075	mm 64x30	con mov. securblock e puls. di sicurezza with securblock system and push button	•	•	•	•	•	•	2

* Placca adatta a movimenti intercambiabili / Plate suitable to interchangeable movements

Per caratteristiche tecniche rosette vedi apposito capitolo soluzioni tecniche e componenti / For technical specifications rosettes see specific section technical solutions and components

A RICHIESTA / ON REQUEST:

- Mezza maniglia con placca o con rosetta (specificare se destra o sinistra) / Half lever handle on plate or on rose (to specify if right or left)
- Maniglia con rosette senza bocchette / Lever handle on rose without rose for key
- Coppie impugnature (CM) con grano e ferro senza rosette e senza bocchette / Pair levers (CM) with grub screws and square pin without rose and without rose for key

art. T42 LUCCA

design: Studio Reguitti
 materiale: Ottone
 material: Solid Brass

Brass Class
 100% Ottone

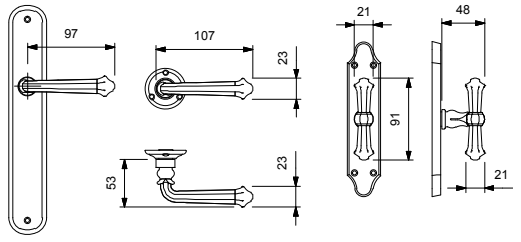

T42 MR T36 - VBN



T42 MR 007 - AGV



T42 MR 009 - AN



T42 MR T36 - LR



T42 MR 416 - VBN



T42 MP 040 - LV



T42 MP 026 - AGV



T42 MA T36 - VBN



T42 DK 015 - VBN



T42 DK 075 - VBN



MANIGLIA CON PLACCA / LEVER HANDLE ON PLATE						€	€	€	€	€	
	T42 MP 026	Maniglia con placca Lever handle on plate	026 mm 225x26	"stretta" "reduced"		•	•	•	•	•	1
	T42 MP 040	Maniglia con placca Lever handle on plate	040 mm 244x40	con molla with spring		•	•	•	•	•	1
	T42 MP 166	Maniglia con placca Lever handle on plate	166 mm 242x33	con molla with spring		•	•	•	•	•	1

MANIGLIA CON ROSETTA / LEVER HANDLE ON ROSE						€	€	€	€	€	
	T42 MR 006	Maniglia con rosetta Lever handle on rose	006 mm Ø50x8	tipo lusso con molla lusso type with spring		•	•	•	•	•	1
	T42 MR 007	Maniglia con rosetta Lever handle on rose	007 mm 67x27	ovale stretta oval and reduced		•	•	•	•	•	2
	T42 MR 009	Maniglia con rosetta Lever handle on rose	009 mm 62x32	ovale con molla oval with spring		•	•	•	•	•	1
	T42 MR 202	Maniglia con rosetta Lever handle on rose	202 mm Ø52x9	con bordo with edge		•	•	•	•	•	2
	T42 MR 416	Maniglia con rosetta Lever handle on rose	416 mm Ø45x9	con molla with spring		•	•	•	•	•	1
T42 MR T36	Maniglia con rosetta Lever handle on rose	T36 mm Ø45x9	con bordo with edge		•	•	•	•	•	2	

MARTELLINA / WINDOW HANDLE WITHOUT MECHANISM						€	€	€	€	€	€
	T42 MA 040*	Martellina su placca Martellina on plate	040 mm 174x37	q.7 with square-pin mm 7		•	•	•	•	•	2
	T42 MA T36	Martellina su rosetta Martellina on rose	T36 mm Ø40	q.7 with square-pin mm 7		•	•	•	•	•	2

CREMONESE / WINDOW HANDLE WITH MECHANISM						€	€	€	€	€	€
	T42 CR 040*	Cremonese con placca Cremon on plate	040 mm 174x37	con gioco with mechanism		•	•	•	•	•	2

DREH KIPP / DREH KIPP						€	€	€	€	€	€
	T42 DK 015	Dreh kipp con rosetta Dreh Kipp on rose	015 mm 65x31	con movimento in metallo with metal mechanism		•	•	•	•	•	3
	T42 DK 075	Dreh kipp con rosetta Dreh Kipp on rose	075 mm 64x30	con mov. securblock e puls. di sicurezza with securblock system and push button		•	•	•	•	•	2

* Placca adatta a movimenti intercambiabili / Plate suitable to interchangeable movements

Per caratteristiche tecniche rosette vedi apposito capitolo soluzioni tecniche e componenti / For technical specifications rosettes see specific section technical solutions and components

A RICHIESTA / ON REQUEST:

- Mezza maniglia con placca o con rosetta (specificare se destra o sinistra) / Half lever handle on plate or on rose (to specify if right or left)
- Maniglia con rosette senza bocchette / Lever handle on rose without rose for key
- Coppie impugnature (CM) con grano e ferro senza rosette e senza bocchette / Pair levers (CM) with grub screws and square pin without rose and without rose for key

art. T88 ELBA

design: Studio Reguitti
materiale: Ottone
material: Solid Brass

Brass Class
100% Ottone

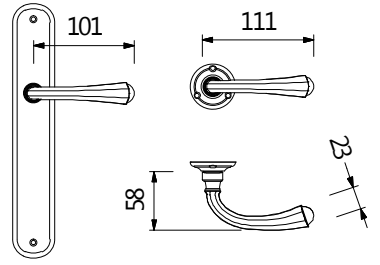

T88 MP 026 - AN

T88 MP 039 - OSC



T88 DK 015 - LV

T88 DK 075 - LV



MANIGLIA CON PLACCA / LEVER HANDLE ON PLATE

			€	€	€	€	€	€				
	T88 MP 026	Maniglia con placca Lever handle on plate	026	mm 225x26	"stretta" "reduced"	•	•	•	•	•	•	1
	T88 MP 039	Maniglia con placca Lever handle on plate	039	mm 255x50	con molla with spring	•	•	•	•	•	•	1
	T88 MP 040	Maniglia con placca Lever handle on plate	040	mm 244x40	con molla with spring	•	•	•	•	•	•	1

MANIGLIA CON ROSETTA / LEVER HANDLE ON ROSE

			€	€	€	€	€	€				
	T88 MR 006	Maniglia con rosetta Lever handle on rose	006	mm Ø50x8	tipo lusso con molla lusso type with spring	•	•	•	•	•	•	1
	T88 MR 007	Maniglia con rosetta Lever handle on rose	007	mm 67x27	ovale stretta oval and reduced	•	•	•	•	•	•	2
	T88 MR 009	Maniglia con rosetta Lever handle on rose	009	mm 62x32	ovale con molla oval with spring	•	•	•	•	•	•	1
	T88 MR 202	Maniglia con rosetta Lever handle on rose	202	mm Ø52x9	con bordo with edge	•	•	•	•	•	•	2
	T88 MR 416	Maniglia con rosetta Lever handle on rose	416	mm Ø45x9	con molla with spring	•	•	•	•	•	•	1
	T88 MR T36	Maniglia con rosetta Lever handle on rose	T36	mm Ø45x9	con bordo with edge	•	•	•	•	•	•	2

MARTELLINA / WINDOW HANDLE WITHOUT MECHANISM

			€	€	€	€	€	€				
	T88 SE 040	Martellina con placca Martellina on plate	040	mm 174x37	q.7 with sq.pin mm 7	•	•	•	•	•	•	2

CREMONESE / WINDOW HANDLE WITH MECHANISM

			€	€	€	€	€	€				
	T88 SG 040	Cremonese con placca Cremon on plate	040	mm 174x37	con gioco with mechanism	•	•	•	•	•	•	2

DREH KIPP / DREH KIPP

			€	€	€	€	€	€				
	T88 DK 015	Dreh kipp con rosetta Dreh Kipp on rose	015	mm 65x31	con movimento in metallo with metal mechanism	•	•	•	•	•	•	3
	T88 DK 075	Dreh kipp con rosetta Dreh Kipp on rose	075	mm 64x30	con mov. securblock e puls. di sicurezza with securblock system and push button	•	•	•	•	•	•	2

Per caratteristiche tecniche rosette vedi apposito capitolo soluzioni tecniche e componenti / For technical specifications rosettes see specific section technical solutions and components

A RICHIESTA / ON REQUEST:

- Mezza maniglia con placca o con rosetta (specificare se destra o sinistra) / Half lever handle on plate or on rose (to specify if right or left)
- Maniglia con rosette senza bocchette / Lever handle on rose without rose for key
- Coppie impugnature (CM) con grano e ferro senza rosette e senza bocchette / Pair levers (CM) with grub screws and square pin without rose and without rose for key

art. Z61 EDNA

design: Studio Reguitti
 materiale: Impugnatura Zama
 material: Lever Zamak

TeKnoMetal
 Linea in zama

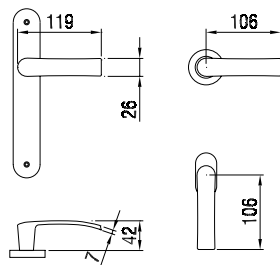

Z61 MR Q86 ZSC



Z61 MR Q86 ZCR



Z61 MR 9Q6 ZSC



Z61 DK Q15 ZSC

VERSIONI / VERSIONS



Finiture
 Finishes

ZSC
 ZCR



MANIGLIA CON ROSETTA / LEVER HANDLE ON ROSE



Z61 MR 9Q6 Maniglia con rosetta 9Q6 mm 61x31 con molla e grano
 Lever Handle on rose with spring and grub screw

•

1



Z61 MR Q86 Maniglia con rosetta Q86 mm 50x50 con molla e grano
 Lever Handle on rose with spring and grub screw

•

1

DREH KIPP / DREH KIPP



Z61 DK Q15 Dreh Kipp con rosetta Q15 mm 65x31 con movimento in metallo
 Dreh Kipp on rose with metal mechanism

•

3

Per caratteristiche tecniche rosette vedi apposito capitolo soluzioni tecniche e componenti / For technical specifications rosettes see specific section technical solutions and components

A RICHIESTA / ON REQUEST:

- Mezza maniglia con placca o con rosetta (specificare se destra o sinistra) / Half lever handle on plate or on rose (to specify if right or left)
- Maniglia con rosette senza bocchette / Lever handle on rose without rose for key
- Coppie impugnature (CM) con grano e ferro senza rosette e senza bocchette / Pair levers (CM) with grub screws and square pin without rose and without rose for key

Porcellana

Porcelain



art. 69 CINZIA

materiale: Ottone - Porcellana
material: Solid Brass - Porcelain

Brass Class
100% Ottone

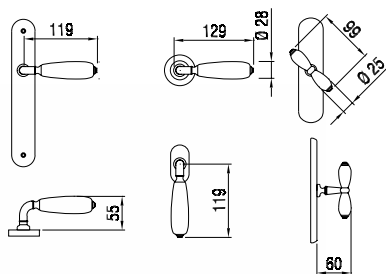

69 MR 202 CHAMP/AN



69 MR 007 CHAMP/AN



69 MR 202 DEC.B/AN



69 MR 202 BN/AN



69 MR 006 DEC.C/AN



69 MR 004 DEC.V/AN



69 MR 004 DEC.H/AN



69 MR 011 BN/AN



69 MR 011 CHAMP/AN



69 MP 040 CHAMP/AN



69 MA 040 CHAMP/AN
69 CR 040 CHAMP/AN



69 DK 015 CHAMP/AN



Finiture
Finishes

BN/AN

DEC.C/AN
CHAMP/AN



DEC.V/AN
DEC.B/AN
DEC.H/AN



MANIGLIA CON PLACCA / LEVER HANDLE ON PLATE

	69 MP 040	Maniglia con placca Lever Handle on plate	040	mm 244x40	con molla e grano with spring and grub screw	•	•	•	1
	69 MP 026	Maniglia con placca Lever Handle on plate	026	mm 225x26	stretta con grano reduced with grub screw	•	•	•	1

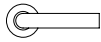
MANIGLIA CON ROSETTA / LEVER HANDLE ON ROSE

	69 MR 004	Maniglia con rosetta Lever Handle on rose	004	mm Ø45x9	con molla e grano with spring and grub screw	•	•	•	1
	69 MR 006	Maniglia con rosetta Lever Handle on rose	006	mm Ø50x8	tipo lusso con molla e grano lusso type with spring and grub screw	•	•	•	1
	69 MR 007	Maniglia con rosetta Lever Handle on rose	007	mm 67x27	ovale stretta con grano oval and reduced with grub screw	•	•	•	1
	69 MR 011	Maniglia con rosetta Lever Handle on rose	011	mm Ø53x11	tipo lusso con molla e grano lusso type with spring and grub screw	•	•	•	1
	69 MR 202	Maniglia con rosetta Lever Handle on rose	202	mm Ø52x9	con bordo con grano with edge with grub screw	•	•	•	1

CREMONESE / WINDOW HANDLE WITH MECHANISM

	69 CR 040*	Cremonese con placca Window Handle on plate	040	mm 174x37	con gioco with mechanism	•	•		2
---	------------	--	-----	-----------	-----------------------------	---	---	--	---

MARTELLINA / WINDOW HANDLE WITHOUT MECHANISM

	69 MA 040*	Martellina con placca Window Handle on plate	040	mm 174x37	q.7 without mechanism with square-pin mm 7	•	•		2
---	------------	---	-----	-----------	---	---	---	--	---

DREH KIPP / DREH KIPP

	69 DK 015	Dreh Kipp con rosetta Dreh Kipp on rose	015	mm 65x31	con movimento in metallo with metal mechanism	•	•	•	3
---	-----------	--	-----	----------	--	---	---	---	---

MANIGLIONE DIRITTO SINGOLO / SINGLE STRAIGHT PULL HANDLE

	102 MD 003	Maniglione Singolo con rosetta Single Pull Handle on rose	003	mm Ø45X7		•	•	•	2
	102 MD 006	Maniglione Singolo con rosetta Single Pull Handle on rose	006	mm Ø50X8	tipo lusso lusso type	•	•	•	2

MANIGLIONE SPOSTATO SINGOLO / SINGLE OFF CENTRE PULL HANDLE

	102 MS 003	Maniglione Singolo con rosetta Single Pull Handle on rose	003	mm Ø45X7		•	•	•	2
	102 MS 006	Maniglione Singolo con rosetta Single Pull Handle on rose	006	mm Ø50X8	tipo lusso lusso type	•	•	•	2

* Placca adatta a movimenti intercambiabili
Plate suitable to interchangeable movements



69 MP 026 BN/AN

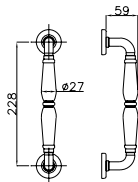

102 MD 006 DEC.C/AN



102 MS 006 CHAMP/AN

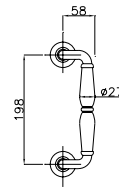

A RICHIESTA / ON REQUEST:

- Mezza maniglia con placca o con rosetta (specificare se destra o sinistra) / Half lever handle on plate or on rose (to specify if right or left)
- Maniglia con rosette senza bocchette / Lever handle on rose without rose for key
- Coppie impugnature (CM) con grano e ferro senza rosette e senza bocchette / Pair levers (CM) with grub screws and square pin without rose and without rose for key
- Cremonesi e martelline con impugnatura a maniglia (segretini)
- Cremonese e martellina con placca coprivite e movimento intercambiabile

art. **69** CINZIA

materiale: Ottone - Porcellana
material: Solid Brass - Porcelain

Brass Class
100% Ottone

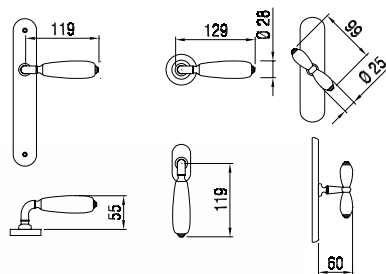

69 MR 006 DEC.C/LV



69 MR 006 DEC.B/LV



69 MR 202 BN/LV



69 MR 006 CHAMP/LV



69 MR 006 DEC.V/LV



69 MR 006 DEC.H/LV



69 MR 011 BN/LV



69 MP 066 DEC.C/LV



69 MA 137 DEC.C/LV
69 CR 137 DEC.C/LV



69 DK 015 DEC.C/LV

VERSIONI / VERSIONS



Finiture
Finishes

BN/LV

CHAMP/LV
DEC.C/LV

DEC. V/LV
DEC. B/LV
DEC. H/LV



MANIGLIA CON PLACCA / LEVER HANDLE ON PLATE

	69 MP 040	Maniglia con placca Lever Handle on plate	040 mm 244x40	con molla e grano with spring and grub screw	•	•	•	1
	69 MP 066	Maniglia con placca Lever Handle on plate	066 mm 240x37	con molla e grano with spring and grub screw	•	•	•	1

MANIGLIA CON ROSETTA / LEVER HANDLE ON ROSE

	69 MR 004	Maniglia con rosetta Lever Handle on rose	004 mm Ø45x9	con molla e grano with spring and grub screw	•	•	•	1
	69 MR 006	Maniglia con rosetta Lever Handle on rose	006 mm Ø50x8	tipo lusso con molla e grano luxu type with spring and grub screw	•	•	•	1
	69 MR 011	Maniglia con rosetta Lever Handle on rose	011 mm Ø53x10	tipo lusso con molla e grano luxu type with spring and grub screw	•	•	•	1
	69 MR 202	Maniglia con rosetta Lever Handle on rose	202 mm Ø52x9	con bordo con grano with edge with grub screw	•	•	•	1

CREMONESE / WINDOW HANDLE WITH MECHANISM

	69 CR 040*	Cremonese con placca Window Handle on plate	040 mm 174x37	con gioco with mechanism	•	•		2
	69 CR 137*	Cremonese con placca Window Handle on plate	137 mm 167x40	con fori viti con gioco with holes for screws with mechanism	•	•		2

MARTELLINA / WINDOW HANDLE WITHOUT MECHANISM

	69 MA 040*	Martellina con placca Window Handle on plate	040 mm 174x37	q.7 without mechanism with square-pin mm 7	•	•		2
	69 MA 137*	Martellina con placca Window Handle on plate	137 mm 167x40	con fori viti q.7 without mechanism with square-pin mm 7	•	•		2

DREH KIPP / DREH KIPP

	69 DK 015	Dreh Kipp con rosetta Dreh Kipp on rose	015 mm 65x31	con movimento in metallo with metal mechanism	•	•	•	3
--	-----------	--	--------------	--	---	---	---	---

MANIGLIONE DIRITTO SINGOLO / SINGLE STRAIGHT PULL HANDLE

	102 MD 003	Maniglione Singolo con rosetta Single Pull Handle on rose	003 mm Ø45x7		•	•	•	2
	102 MD R46	Maniglione Singolo con rosetta Single Pull Handle on rose	R46 mm Ø46x8	tipo lusso luxu type	•	•	•	2

MANIGLIONE SPOSTATO SINGOLO / SINGLE OFF CENTRE PULL HANDLE

	102 MS 003	Maniglione Singolo con rosetta Single Pull Handle on rose	003 mm Ø45x7		•	•	•	2
	102 MS R46	Maniglione Singolo con rosetta Single Pull Handle on rose	R46 mm Ø46x8	tipo lusso luxu type	•	•	•	2

* Placca adatta a movimenti intercambiabili
Plate suitable to interchangeable movements



69 MP 040 CHAMP/LV



69 MA 040 CHAMP/LV
69 CR 040 CHAMP/LV

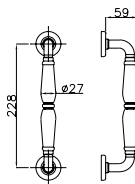

102 MD R46 DEC.C/LV



102 MS R46 DEC.C/LV

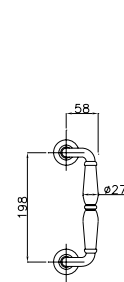

A RICHIESTA / ON REQUEST:

- Mezza maniglia con placca o con rosetta (specificare se destra o sinistra) / Half lever handle on plate or on rose (to specify if right or left)
- Maniglia con rosette senza bocchette / Lever handle on rose without rose for key
- Coppie impugnature (CM) con grano e ferro senza rosette e senza bocchette / Pair levers (CM) with grub screws and square pin without rose and without rose for key
- Cremonesi e martelline con impugnatura a maniglia (segretini)
- Cremonese e martellina con placca coprivite e movimento intercambiabile

art. **69** CINZIA

materiale: Ottone - Porcellana
material: Solid Brass - Porcelain

Brass Class
100% Ottone

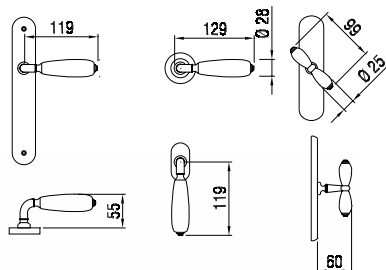

69 MR 006 NR/AGV



69 MR 011 BN/AGV



69 MR 007 CHAMP/AGV



69 MR 202 CHAMP/AGV



69 MR 006 DEC.C/AGV



69 MR 003 BN/AGV



69 MP 040 CHAMP/AGV



69 MA 040 CHAMP/AGV
69 CR 040 CHAMP/AGV



69 DK 015 CHAMP/AGV



					BN/AGV	CHAMP/AGV DEC. C/AGV	NR/AGV	
MANIGLIA CON PLACCA / LEVER HANDLE ON PLATE								
	69 MP 040	Maniglia con placca Lever Handle on plate	040 mm 244x40	con molla e grano with spring and grub screw	•	•	•	1
MANIGLIA CON ROSETTA / LEVER HANDLE ON ROSE								
	69 MR 003	Maniglia con rosetta Lever Handle on rose	003 mm Ø45x7	con molla e grano with spring and grub screw	•	•	•	1
	69 MR 006	Maniglia con rosetta Lever Handle on rose	006 mm Ø50x8	tipo lusso con molla e grano lusso type with spring and grub screw	•	•	•	1
	69 MR 007	Maniglia con rosetta Lever Handle on rose	007 mm 67x27	ovale stretta con grano oval and reduced with grub screw	•	•	•	1
	69 MR 011	Maniglia con rosetta Lever Handle on rose	011 mm Ø53x10	tipo lusso con molla e grano lusso type with spring and grub screw	•	•	•	1
	69 MR 202	Maniglia con rosetta Lever Handle on rose	202 mm Ø52x9	con bordo con grano with edge with grub screw	•	•	•	1
CREMONESE / WINDOW HANDLE WITH MECHANISM								
	69 CR 040*	Cremonese con placca Window Handle on plate	040 mm 174x37	con gioco with mechanism	•	•	•	2
MARTELLINA / WINDOW HANDLE WITHOUT MECHANISM								
	69 MA 040*	Martellina con placca Window Handle on plate	040 mm 174x37	q.7 without mechanism with square-pin mm 7	•	•	•	2
DREH KIPP / DREH KIPP								
	69 DK 015	Dreh Kipp con rosetta Dreh Kipp on rose	015 mm 65x31	con movimento in metallo with metal mechanism	•	•	•	3
	69 DK C67	Dreh Kipp con rosetta Safety DK on rose	C67 mm 69x33	c/chiave e cilindro e mov. in metallo with key and cylinder and metal mec.	•	•	•	1

* Placca adatta a movimenti intercambiabili
Plate suitable to interchangeable movements



69 DK C67 BN/AGV



53 PR 003 BN/AGV

Vedi pag 464
See page 464

Per caratteristiche tecniche rosette vedi apposito capitolo soluzioni tecniche e componenti / For technical specifications rosettes see specific section technical solutions and components

A RICHIESTA / ON REQUEST:

- Mezza maniglia con placca o con rosetta (specificare se destra o sinistra) / Half lever handle on plate or on rose (to specify if right or left)
- Maniglia con rosette senza bocchette / Lever handle on rose without rose for key
- Coppie impugnature (CM) con grano e ferro senza rosette e senza bocchette / Pair levers (CM) with grub screws and square pin without rose and without rose for key
- Cremonesi e martelline con impugnatura a maniglia (segretini)
- Cremonese e martellina con placca coprivite e movimento intercambiabile

art. 69 CINZIA

materiale: Ottone - Porcellana
material: Solid Brass - Porcelain

Brass Class
100% Ottone



69 MR 006 NR/OC

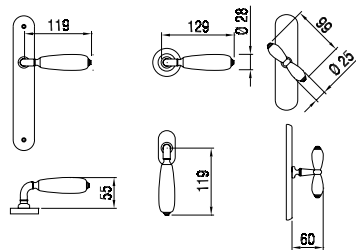

69 MR 006 BN/OC



69 MR 006 BN/OSC



69 MR 009 BN/OSC



69 DK 015 NR/OSC



69 MP 066 NR/OSC

VERSIONI / VERSIONS



Finiture
Finishes

MANIGLIA CON PLACCA / LEVER HANDLE ON PLATE				BN/OC BN/OSC	NR/OC NR/OSC	
69 MP 066	Maniglia con placca Lever Handle on plate	066 mm 240x37	con molla e grano with spring and grub screw	•	•	1
69 MP 026	Maniglia con placca Lever Handle on plate	026 mm 225x26	stretta con grano reduced with grub screw	•	•	1
MANIGLIA CON ROSETTA / LEVER HANDLE ON ROSE						
69 MR 004	Maniglia con rosetta Lever Handle on rose	004 mm Ø45x9	con molla e grano with spring and grub screw	•	•	1
69 MR 006	Maniglia con rosetta Lever Handle on rose	006 mm Ø50x8	tipo lusso con molla e grano luxu type with spring and grub screw	•	•	1
69 MR 009	Maniglia con rosetta Lever Handle on rose	009 mm 62x32	ovale con molla e grano oval with spring and grub screw	•	•	1
CREMONESE / WINDOW HANDLE WITH MECHANISM						
69 CR 137*	Cremonese con placca Window Handle on plate	137 mm 167x40	con fori viti con gioco with holes for screws with mechanism	•	•	2
MARTELLINA / WINDOW HANDLE WITHOUT MECHANISM						
69 MA 137*	Martellina con placca Window Handle on plate	137 mm 167x40	con fori viti q.7 without mechanism with square-pin mm 7	•	•	2
DREH KIPP / DREH KIPP						
69 DK 015	Dreh Kipp con rosetta Dreh Kipp on rose	015 mm 65x31	con movimento in metallo with metal mechanism	•	•	3

* Placca adatta a movimenti intercambiabili
Plate suitable to interchangeable movements

A RICHIESTA / ON REQUEST:

- Mezza maniglia con placca o con rosetta (specificare se destra o sinistra) / Half lever handle on plate or on rose (to specify if right or left)
- Maniglia con rosette senza bocchette / Lever handle on rose without rose for key
- Coppie impugnature (CM) con grano e ferro senza rosette e senza bocchette / Pair levers (CM) with grub screws and square pin without rose and without rose for key
- Cremonesi e martelline con impugnatura a maniglia (segretini)
- Cremonese e martellina con placca coprivite e movimento intercambiabile

art. 69 CINZIA

materiale: Ottone - Porcellana
material: Solid Brass - Porcelain

Brass Class
100% Ottone



69 MR 416 DEC.C/RX

Finiture
Finishes

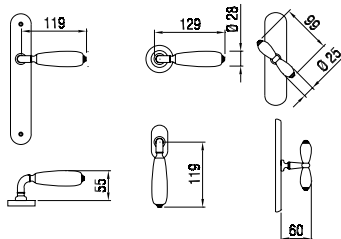

69 MR 007 CHAMP/RX



69 MR 006 DEC.H/RX



69 MR 202 DEC.C/RX



69 DK 015 DEC.C/RX



69 MP 040 DEC.H/RX

VERSIONI / VERSIONS



Finiture
Finishes

MANIGLIA CON PLACCA / LEVER HANDLE ON PLATE				BN/RX	CHAMP/RX DEC.C/RX	DEC.H/RX DEC.B/RX DEC.V/RX	
69 MP 040	Maniglia con placca Lever Handle on plate	040 mm 244x40	con molla e grano with spring and grub screw	•	•	•	1
69 MP 026	Maniglia con placca Lever Handle on plate	026 mm 225x26	stretta con grano reduced with grub screw	•	•	•	1
MANIGLIA CON ROSETTA / LEVER HANDLE ON ROSE				BN/RX	CHAMP/RX DEC.C/RX	DEC.H/RX DEC.B/RX DEC.V/RX	
69 MR 004	Maniglia con rosetta Lever Handle on rose	004 mm Ø45x9	con molla e grano with spring and grub screw	•	•	•	1
69 MR 006	Maniglia con rosetta Lever Handle on rose	006 mm Ø50x8	tipo lusso con molla e grano luxury type with spring and grub screw	•	•	•	1
69 MR 007	Maniglia con rosetta Lever Handle on rose	007 mm 67x27	ovale stretta con grano oval and reduced with grub screw	•	•	•	1
69 MR 202	Maniglia con rosetta Lever Handle on rose	202 mm Ø52x9	con bordo con grano with grub screw	•	•	•	1
69 MR 416	Maniglia con rosetta Lever Handle on rose	416 mm Ø45x9	con molla e grano with spring and grub screw	•	•	•	1
CREMONESE / WINDOW HANDLE WITH MECHANISM				BN/RX	CHAMP/RX DEC.C/RX	DEC.H/RX DEC.B/RX DEC.V/RX	
69 CR 040*	Cremonese con placca Window Handle on plate	040 mm 174x37	con gioco with mechanism	•	•	•	2
MARTELLINA / WINDOW HANDLE WITHOUT MECHANISM				BN/RX	CHAMP/RX DEC.C/RX	DEC.H/RX DEC.B/RX DEC.V/RX	
69 MA 040*	Martellina con placca Window Handle on plate	040 mm 174x37	q.7 without mechanism with square-pin mm 7	•	•	•	2
DREH KIPP / DREH KIPP				BN/RX	CHAMP/RX DEC.C/RX	DEC.H/RX DEC.B/RX DEC.V/RX	
69 DK 015	Dreh Kipp con rosetta Dreh Kipp on rose	015 mm 65x31	con movimento in metallo with metal mechanism	•	•	•	3

* Placca adatta a movimenti intercambiabili
Plate suitable to interchangeable movements

A RICHIESTA / ON REQUEST:

- Mezza maniglia con placca o con rosetta (specificare se destra o sinistra) / Half lever handle on plate or on rose (to specify if right or left)
- Maniglia con rosette senza bocchette / Lever handle on rose without rose for key
- Coppie impugnature (CM) con grano e ferro senza rosette e senza bocchette / Pair levers (CM) with grub screws and square pin without rose and without rose for key
- Cremonesi e martelline con impugnatura a maniglia (segretini)
- Cremonese e martellina con placca coprivite e movimento intercambiabile

art. 69 CINZIA

materiale: Ottone - Porcellana
material: Solid Brass - Porcelain

Brass Class
100% Ottone



69 MR 004 CHAMP/VBN

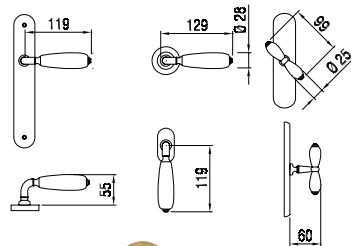

69 MR 006 BN/VBN



69 MR 006 DEC.C/VBN



69 CR 040 CHAMP/VBN
69 MA 040 CHAMP/VBN



69 DK 015 DEC.C/VBN



69 MP 040 CHAMP/VBN

VERSIONI / VERSIONS



Finire
Finishes

				BN/VBN	CHAMP/VBN DEC.C/VBN	
MANIGLIA CON PLACCA / LEVER HANDLE ON PLATE						
69 MP 040	Maniglia con placca Lever Handle on plate	040	mm 244x40 con molla e grano with spring and grub screw	•	•	1
MANIGLIA CON ROSETTA / LEVER HANDLE ON ROSE						
69 MR 004	Maniglia con rosetta Lever Handle on rose	004	mm Ø45x9 con molla e grano with spring and grub screw	•	•	1
69 MR 006	Maniglia con rosetta Lever Handle on rose	006	mm Ø50x8 tipo lusso con molla e grano lusso type with spring and grub screw	•	•	1
69 MR 007	Maniglia con rosetta Lever Handle on rose	007	mm 67x27 ovale stretta con grano oval and reduced with grub screw	•	•	1
69 MR 202	Maniglia con rosetta Lever Handle on rose	202	mm Ø52x9 con bordo con grano with grub screw	•	•	1
CREMONESE / WINDOW HANDLE WITH MECHANISM						
69 CR 040*	Cremonese con placca Window Handle on plate	040	mm 174x37 con gioco with mechanism	•	•	2
MARTELLINA / WINDOW HANDLE WITHOUT MECHANISM						
69 MA 040*	Martellina con placca Window Handle on plate	040	mm 174x37 q.7 without mechanism with square-pin mm 7	•	•	2
DREH KIPP / DREH KIPP						
69 DK 015	Dreh Kipp con rosetta Dreh Kipp on rose	015	mm 65x31 con movimento in metallo with metal mechanism	•	•	3

* Placca adatta a movimenti intercambiabili
Plate suitable to interchangeable movements

A RICHIESTA / ON REQUEST:

- Mezza maniglia con placca o con rosetta (specificare se destra o sinistra) / Half lever handle on plate or on rose (to specify if right or left)
- Maniglia con rosette senza bocchette / Lever handle on rose without rose for key
- Coppie impugnature (CM) con grano e ferro senza rosette e senza bocchette / Pair levers (CM) with grub screws and square pin without rose and without rose for key
- Cremonesi e martelline con impugnatura a maniglia (segretini)
- Cremonese e martellina con placca coprivite e movimento intercambiabile

art. 69 CINZIA

materiale: Ottone - Porcellana
material: Solid Brass - Porcelain

Brass Class
100% Ottone



69 MR 006 DEC.H/BGO

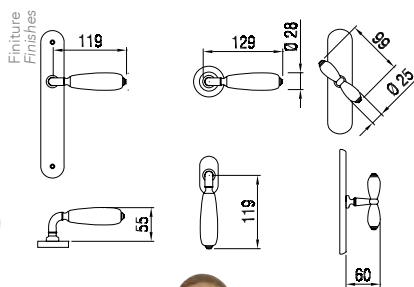

69 MR 006 DEC.V/BGO



69 MR 006 DEC.B/BGO



69 CR 040 CHAMP/BGO
69 MA 040 CHAMP/BGO



69 DK 015 CHAMP/BGO



69 MP 040 CHAMP/BGO

VERSIONI / VERSIONS



MANIGLIA CON PLACCA / LEVER HANDLE ON PLATE

69 MP 040	Maniglia con placca Lever Handle on plate	040 mm 244x40	con molla e grano with spring and grub screw	•	•	•	1
69 MP 026	Maniglia con placca Lever Handle on plate	026 mm 225x26	stretta con grano reduced with grub screw	•	•	•	1

MANIGLIA CON ROSETTA / LEVER HANDLE ON ROSE

69 MR 004	Maniglia con rosetta Lever Handle on rose	004 mm Ø45x9	con molla e grano with spring and grub screw	•	•	•	1
69 MR 006	Maniglia con rosetta Lever Handle on rose	006 mm Ø50x8	tipo lusso con molla e grano luxury type with spring and grub screw	•	•	•	1
69 MR 007	Maniglia con rosetta Lever Handle on rose	007 mm 67x27	ovale stretta con grano oval and reduced with grub screw	•	•	•	1
69 MR 202	Maniglia con rosetta Lever Handle on rose	202 mm Ø52x9	con bordo con grano with grub screw	•	•	•	1
69 MR 416	Maniglia con rosetta Lever Handle on rose	416 mm Ø45x9	con molla e grano with spring and grub screw	•	•	•	1

CREMONESE / WINDOW HANDLE WITH MECHANISM

69 CR 040*	Cremonese con placca Window Handle on plate	040 mm 167x40	con gioco with mechanism	•	•		2
------------	--	---------------	-----------------------------	---	---	--	---

MARTELLINA / WINDOW HANDLE WITHOUT MECHANISM

69 MA 040*	Martellina con placca Window Handle on plate	040 mm 167x40	q.7 without mechanism with square-pin mm 7	•	•		2
------------	---	---------------	---	---	---	--	---

DREH KIPP / DREH KIPP

69 DK 015	Dreh Kipp con rosetta Dreh Kipp on rose	015 mm 65x31	con movimento in metallo with metal mechanism	•	•	•	3
-----------	--	--------------	--	---	---	---	---

* Placca adatta a movimenti intercambiabili
Plate suitable to interchangeable movements

A RICHIESTA / ON REQUEST:

- Mezza maniglia con placca o con rosetta (specificare se destra o sinistra) / Half lever handle on plate or on rose (to specify if right or left)
- Maniglia con rosette senza bocchette / Lever handle on rose without rose for key
- Coppie impugnature (CM) con grano e ferro senza rosette e senza bocchette / Pair levers (CM) with grub screws and square pin without rose and without rose for key
- Cremonesi e martelline con impugnatura a maniglia (segretini)
- Cremonese e martellina con placca coprivite e movimento intercambiabile

art. 168 SANDRA

design: Studio Reguitti
 materiale: Ottone - Porcellana
 material: Solid Brass - Porcelain

Brass Class
 100% Ottone

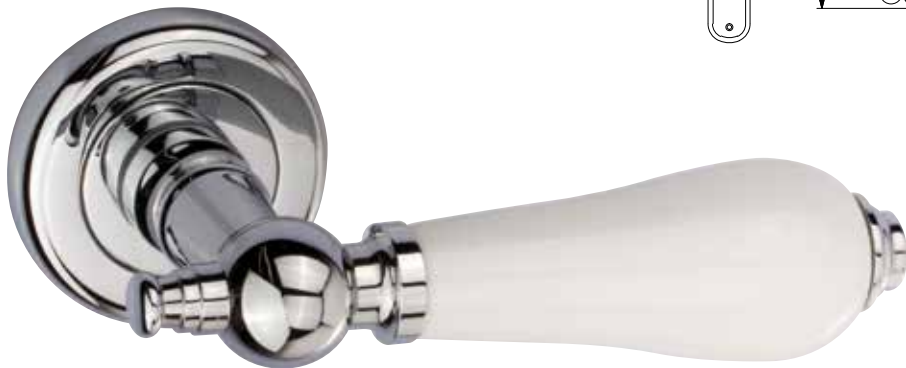
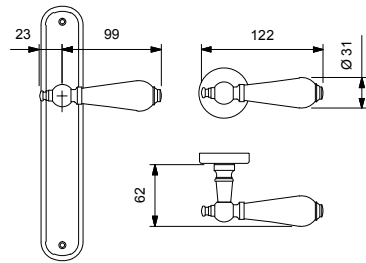

168 MR 006 - BN/OC



168 MR 011 - BN/AN



168 MR 202 - BN/AN



168 MR 009 - BN/AN



168 MR 004 - BN/OSC



168 MR 006 - BN/LV



168 MP 039 - BN/OSC



168 MP 040 - BN/OSC



168 DK 015 - BN/OSC



168 DK 075 - BN/OC



MANIGLIA CON PLACCA / LEVER HANDLE ON PLATE

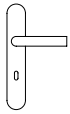

			€	€	€		
168 MP 039	Maniglia con placca Lever handle on plate	039 mm 255x50	con molla with spring	•	•	•	1
168 MP 040	Maniglia con placca Lever handle on plate	040 mm 244x40	con molla with spring	•	•	•	1

MANIGLIA CON ROSETTA / LEVER HANDLE ON ROSE



				€	€	€	
168 MR 004	Maniglia con rosetta Lever handle on rose	004 mm Ø45x9	con molla with spring	•	•	•	1
168 MR 006	Maniglia con rosetta Lever handle on rose	006 mm Ø50x8	tipo lusso con molla lusso type with spring	•	•	•	1
168 MR 007	Maniglia con rosetta Lever handle on rose	007 mm 67x27	ovale stretta oval and reduced	•	•	•	1
168 MR 009	Maniglia con rosetta Lever handle on rose	009 mm 62x32	ovale con molla oval with spring	•	•	•	1
168 MR 011	Maniglia con rosetta Lever handle on rose	011 mm Ø53x10	tipo lusso con molla lusso type with spring	•	•	•	1
168 MR 202	Maniglia con rosetta Lever handle on rose	202 mm Ø52x9	con bordo with edge	•	•	•	1

MARTELLINA / WINDOW HANDLE WITHOUT MECHANISM

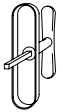

				€	€	€	
168 MA 040*	Martellina su placca Martellina on plate	040 mm 174x37	9,7 with square-pin mm 7	•	•	•	2

CREMONESE / WINDOW HANDLE WITH MECHANISM



				€	€	€	
168 CR 040*	Cremonese con placca Cremon on plate	040 mm 174x37	con gioco with mechanism	•	•	•	2

DREH KIPP / DREH KIPP



				€	€	€	
168 DK 015	Dreh kipp con rosetta Dreh Kipp on rose	015 mm 65x31	con movimento in metallo with metal mechanism	•	•	•	3
168 DK 075	Dreh kipp con rosetta Dreh Kipp on rose	075 mm 64x30	con mov. securblock e puls. di sicurezza with securblock system and push button	•	•	•	2

* Placca adatta a movimenti intercambiabili / Plate suitable to interchangeable movements

Per caratteristiche tecniche rosette vedi apposito capitolo soluzioni tecniche e componenti / For technical specifications rosettes see specific section technical solutions and components

A RICHIESTA / ON REQUEST:

- Mezza maniglia con placca o con rosetta (specificare se destra o sinistra) / Half lever handle on plate or on rose (to specify if right or left)
- Maniglia con rosette senza bocchette / Lever handle on rose without rose for key
- Coppie impugnature (CM) con grano e ferro senza rosette e senza bocchette / Pair levers (CM) with grub screws and square pin without rose and without rose for key

art. 172 HANSEL

materiale: Ottone - Porcellana
material: Solid Brass - Porcelain

Brass Class
100% Ottone



172 MR 006 BN/LV

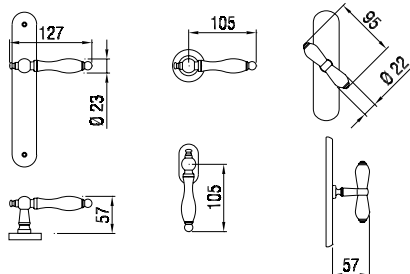

172 MR 009 CHAMP/LV



172 MR 007 CHAMP/LV



172 DK 015 CHAMP/LV



172 MP 040 CHAMP/LV

VERSIONI / VERSIONS



MANIGLIA CON PLACCA / LEVER HANDLE ON PLATE

					BN/LV	CHAMP/LV	BN/AN	CHAMP/AN	
172 MP 040	Maniglia con placca Lever Handle on plate	040	mm 244x40	con molla e grano with spring and grub screw	•	•	•	•	1
172 MP 039	Maniglia con placca Lever Handle on plate	039	mm 255x50	con molla e grano with spring and grub screw	•	•	•	•	1

MANIGLIA CON ROSETTA / LEVER HANDLE ON ROSE

172 MR 004	Maniglia con rosetta Lever Handle on rose	004	mm Ø45x9	con molla e grano with spring and grub screw	•	•	•	•	1
172 MR 006	Maniglia con rosetta Lever Handle on rose	006	mm Ø50x8	tipo lusso con molla e grano luxu type with spring and grub screw	•	•	•	•	1
172 MR 007	Maniglia con rosetta Lever Handle on rose	007	mm 67x27	ovale stretta con grano oval and reduced with grub screw	•	•	•	•	1
172 MR 009	Maniglia con rosetta Lever Handle on rose	009	mm 62x32	ovale con molla e grano oval with spring and grub screw	•	•	•	•	1
172 MR 202	Maniglia con rosetta Lever Handle on rose	202	mm Ø52x9	con bordo con grano with edge with grub screw	•	•	•	•	1

CREMONESE / WINDOW HANDLE WITH MECHANISM

172 CR 040*	Cremonese con placca Window Handle on plate	040	mm 174x37	con gioco with mechanism	•	•	•	•	2
-------------	--	-----	-----------	-----------------------------	---	---	---	---	---

MARTELLINA / WINDOW HANDLE WITHOUT MECHANISM

172 MA 040*	Martellina con placca Window Handle on plate	040	mm 174x37	q. 7 without mechanism with square-pin mm 7	•	•	•	•	2
-------------	---	-----	-----------	--	---	---	---	---	---

DREH KIPP / DREH KIPP

172 DK 015	Dreh Kipp con rosetta Dreh Kipp on rose	015	mm 65x31	con movimento in metallo with metal mechanism	•	•	•	•	3
------------	--	-----	----------	--	---	---	---	---	---

*Placca adatta a movimenti intercambiabili - Plate suitable to interchangeable movements

A RICHIESTA / ON REQUEST:

- Mezza maniglia con placca o con rosetta (specificare se destra o sinistra) / Half lever handle on plate or on rose (to specify if right or left)
- Maniglia con rosette senza bocchette / Lever handle on rose without rose for key
- Coppie impugnature (CM) con grano e ferro senza rosette e senza bocchette / Pair levers (CM) with grub screws and square pin without rose and without rose for key
- Cremonesi e martelline con impugnatura a maniglia (segretini)

art. 174 GRETEL

materiale: Ottone - Porcellana
material: Solid Brass - Porcelain

Brass Class
100% Ottone

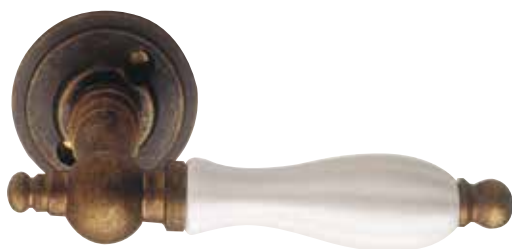

174 MR 202 BN/AN

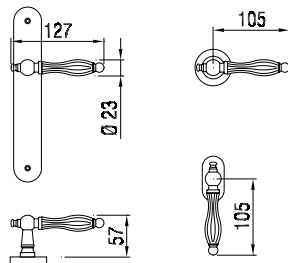

174 MR 006 CHAMP/LV



174 MR 006 CHAMP/AN



174 DK 015 BN/LV



174 MP 039 BN/LV

VERSIONI / VERSIONS



Finiture
Finishes

MANIGLIA CON PLACCA / LEVER HANDLE ON PLATE

					BN/LV	CHAMP/LV	BN/AN	CHAMP/AN	
174 MP 040	Maniglia con placca Lever Handle on plate	040	mm 244x40	con molla e grano with spring and grub screw	•	•	•	•	1
174 MP 039	Maniglia con placca Lever Handle on plate	039	mm 255x50	con molla e grano with spring and grub screw	•	•	•	•	1
174 MP 026	Maniglia con placca Lever Handle on plate	026	mm 225x26	stretta con grano reduced with grub screw	•	•	•	•	1

MANIGLIA CON ROSETTA / LEVER HANDLE ON ROSE

174 MR 004	Maniglia con rosetta Lever Handle on rose	004	mm Ø45x9	con molla e grano with spring and grub screw	•	•	•	•	1
174 MR 006	Maniglia con rosetta Lever Handle on rose	006	mm Ø50x8	tipo lusso con molla e grano lusso type with spring and grub screw	•	•	•	•	1
174 MR 007	Maniglia con rosetta Lever Handle on rose	007	mm 67x27	ovale stretta con grano oval and reduced with grub screw	•	•	•	•	1
174 MR 202	Maniglia con rosetta Lever Handle on rose	202	mm Ø52x9	con bordo con grano with edge with grub screw	•	•	•	•	1

DREH KIPP / DREH KIPP

174 DK 015	Dreh Kipp con rosetta Dreh Kipp on rose	015	mm 65x31	con movimento in metallo with metal mechanism	•	•	•	•	3
------------	--	-----	----------	--	---	---	---	---	---

Per caratteristiche tecniche rosette vedi apposito capitolo soluzioni tecniche e componenti / For technical specifications rosettes see specific section technical solutions and components

A RICHIESTA / ON REQUEST:

- Mezza maniglia con placca o con rosetta (specificare se destra o sinistra) / Half lever handle on plate or on rose (to specify if right or left)
- Maniglia con rosette senza bocchette / Lever handle on rose without rose for key
- Coppie impugnature (CM) con grano e ferro senza rosette e senza bocchette / Pair levers (CM) with grub screws and square pin without rose and without rose for key
- Cremonesi e martelline con impugnatura a maniglia (segretini)

art. 82 SUSY

materiale: Ottone - Porcellana
material: Solid Brass - Porcelain

Brass Class
100% Ottone



82 MR 005 BN/LV

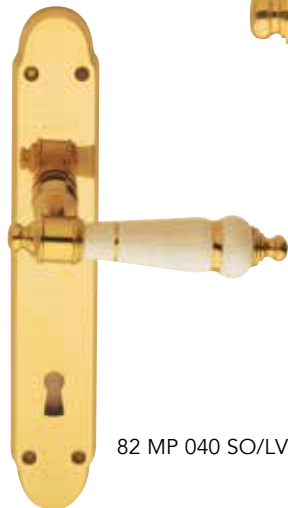
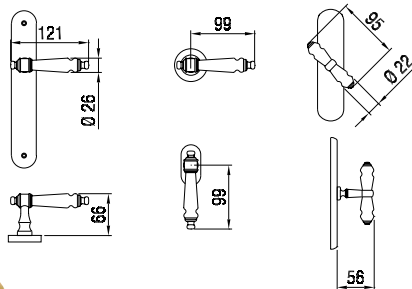

82 MP 040 SO/LV



82 DK 015 SO/LV



82 MA 040 BN/LV
82 CR 040 BN/LV



53 MA 040 BN/LV
53 CR 040 BN/LV

VERSIONI / VERSIONS



MANIGLIA CON PLACCA / LEVER HANDLE ON PLATE				BN/LV	SO/LV	
82 MP 040	Maniglia con placca Lever Handle on plate	040 mm 244x40	con molla e grano with spring and grub screw	•	•	1
MANIGLIA CON ROSETTA / LEVER HANDLE ON ROSE						
82 MR 004	Maniglia con rosetta Lever Handle on rose	004 mm Ø45x9	con molla e grano with spring and grub screw	•	•	1
82 MR 005	Maniglia con rosetta Lever Handle on rose	005 mm Ø50x8	tipo lusso con molla e grano luxu type with spring and grub screw	•	•	1
CREMONESE / WINDOW HANDLE WITH MECHANISM						
82 CR 040*	Cremonese con placca Window Handle on plate	040 mm 174x37	con gioco with mechanism	•		2
53 CR 040	Cremonese con placca Window Handle on plate	040 mm 174x37	con gioco with mechanism	•		2
MARTELLINA / WINDOW HANDLE WITHOUT MECHANISM						
82 MA 040*	Martellina con placca Window Handle on plate	040 mm 174x37	q.7 without mechanism with square-pin mm 7	•		2
53 MA 040	Martellina con placca Window Handle on plate	040 mm 174x37	q.7 without mechanism with square-pin mm 7	•		2
DREH KIPP / DREH KIPP						
82 DK 015	Dreh Kipp con rosetta Dreh Kipp on rose	015 mm 65x31	con movimento in metallo with metal mechanism	•	30,62	3

* Placca adatta a movimenti intercambiabili - Plate suitable to interchangeable movements

A RICHIESTA / ON REQUEST:

- Mezza maniglia con placca o con rosetta (specificare se destra o sinistra) / Half lever handle on plate or on rose (to specify if right or left)
- Maniglia con rosette senza bocchette / Lever handle on rose without rose for key
- Coppie impugnature (CM) con grano e ferro senza rosette e senza bocchette / Pair levers (CM) with grub screws and square pin without rose and without rose for key
- Cremonesi e martelline con impugnatura a maniglia (segretini)
- Cremonese e martellina con placca coprivite e movimento intercambiabile

art. 51

materiale: Ottone - Porcellana
material: Solid Brass - Porcelain

Brass Class
100% Ottone

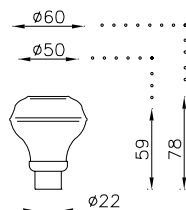

C51 PR 005 SO/LV

Esempio frontale di coppia
Frontal view of pair knob



C51 PR 005 BN/LV



E51 PO R56 BN/LV

VERSIONI / VERSIONS



Finire
Finishes

				BN/LV	SO/LV	
COPPIA POMOLO GIREVOLE CON ROSETTA / PAIR KNOB ON ROSE						
C51 PR 003	Coppia Pomolo Ø50 con rosetta Pair Knob Ø50 on rose	003	con grano with grub screw	•	•	2
C51 PR 005	Coppia Pomolo Ø50 con rosetta Pair Knob Ø50 on rose	005	tipo lusso con grano lusso type with grub screw	•	•	2
E51 PR 003	Coppia Pomolo Ø60 con rosetta Pair Knob Ø60 on rose	003	con grano with grub screw	•	•	2
E51 PR 005	Coppia Pomolo Ø60 con rosetta Pair Knob Ø60 on rose	005	tipo lusso con grano lusso type with grub screw	•	•	2
POMOLO FISSO SU ROSETTA CON FISSAGGIO A TRONCONE FILETTATO / FIXED SINGLE KNOB WITH THREADED SCREW FIXING						
C51 PO R56	Pomolo Singolo Ø50 con rosetta Single Knob Ø50 on rose	R56	Ø70 con troncone Ø70 with threaded screw	•	•	2
E51 PO R56	Pomolo Singolo Ø60 con rosetta Single Knob Ø60 on rose	R56	Ø70 con troncone Ø70 with threaded screw	•	•	2

Per caratteristiche tecniche rosette vedi apposito capitolo soluzioni tecniche e componenti / For technical specifications rosettes see specific section technical solutions and components

A RICHIESTA / ON REQUEST:

- Mezza maniglia con placca o con rosetta (specificare se destra o sinistra) / Half lever handle on plate or on rose (to specify if right or left)
- Maniglia con rosette senza bocchette / Lever handle on rose without rose for key
- Coppie impugnature (CM) con grano e ferro senza rosette e senza bocchette / Pair levers (CM) with grub screws and square pin without rose and without rose for key

art. 53

Brass Class
100% Ottone

53 PR 005 BN/LV

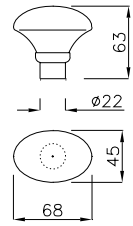

Esempi frontali di coppie
Frontal view of pair knob



53 MA 007 BN/LV



53 TK 015 BN/LV



53 MA 137 BN/LV
53 CR 137 BN/LV



53 PP 066 BN/LV



53 MA 040 BN/LV
53 CR 040 BN/LV



53 PR 006 DEC.C/AN



53 PR 003 BN/AN



53 PR 003 BN/AGV



53 PR 202 CHAMP/AGV



53 PR R40 BN/LV



P2



53 PF 006 DEC.C/AN

art. 284-285



284 PA BN/LV



284 PA DEC.C/LV



285 PA 060 SO/LV



Finiture
Finishes

				BN/LV	CHAMP/LV DEC.C/LV	BN/AN	CHAMP/AN DEC.C/AN	BN/AGV	CHAMP/AGV DEC.C/AGV	
POMOLO SU ROSETTA CON FISSAGGIO A PIASTRINA / KNOB ON ROSE WITH SMALL PLATE FIXING										
	53 PF 006	Pomolo Fisso con rosetta Fixed Knob on rose	006	tipo lusso con grano lusso type with grub screw	•	•	•	•	•	2
COPPIA POMOLO CON ROSETTA / PAIR KNOB ON ROSE										
	53 PR 003	Coppia Pomolo con rosetta Pair Knob on rose	003	con grano with grub screw	•	•	•	•	•	2
	53 PR 005	Coppia Pomolo con rosetta Pair Knob on rose	005	tipo lusso con grano lusso type with grub screw	•	•				2
	53 PR 006	Coppia Pomolo con rosetta Pair Knob on rose	006	tipo lusso con grano lusso type with grub screw	•	•	•	•	•	2
	53 PR 202	Coppia Pomolo con rosetta Pair Knob on rose	202	con bordo con grano with edge with grub screw	•	•	•	•	•	2
	53 PR R40	Coppia Pomolo con rosetta Pair Knob on rose	R40	con fori viti con grano with holes for screw with grub screw	•	•	•	•	•	2
COPPIA POMOLO CON PLACCA / PAIR KNOB ON PLATE										
	53 PP 040	Coppia Pomolo con placca Pair Knob on plate	040	con grano with grub screw	•	•	•	•	•	1
	53 PP 066	Coppia Pomolo con placca Pair Knob on plate	066	con grano with grub screw	•	•				1
CREMONESE / WINDOW HANDLE WITH MECHANISM										
	53 CR 040	Cremonese con placca Window Handle on plate	040	con gioco with mechanism	•	•	•	•	•	2
	53 CR 137	Cremonese con placca Window Handle on plate	137	con fori viti con gioco with holes for screws with mechanism	•	•	•	•		2
MARTELLINA / WINDOW HANDLE WITHOUT MECHANISM										
	53 MA 007	Martellina con placca Window Handle on plate	007	q.7 without mechanism with square-pin mm 7	•	•	•	•	•	2
	53 MA 040	Martellina con placca Window Handle on plate	040	q.7 without mechanism with square-pin mm 7	•	•	•	•	•	2
	53 MA 137	Martellina con placca Window Handle on plate	137	con fori viti q.7 without mechanism with square-pin mm 7	•	•	•	•		2
DREH KIPP / DREH KIPP										
	53 TK 015	Dreh Kipp con rosetta Dreh Kipp on rose	015	con impugnatura martellina a "T" shape "T"	•	•	•	•	•	3

Per caratteristiche tecniche rosette vedi apposito capitolo soluzioni tecniche e componenti / For technical specifications rosettes see specific section technical solutions and components

A RICHIESTA / ON REQUEST:

- Mezza coppia pomolo con placca o con rosetta / Half pair knob on plate or on rose
- Coppie pomolo con rosetta senza bocchetta / Pair knob on rose without rose for key



				BN/LV	CHAMP/LV DEC.C/LV	
PORTABITO / COAT HOOK						
	284 PA	Portabito con pomolo ovale in porcellana Coat hook with oval knob in porcelain		•	•	4
PORTABITO / COAT HOOK						
	285 PA 050	Portabito con pomolo Ø50 in porcellana Coat hook with round knob Ø50 in porcelain		•	•	4
	285 PA 060	Portabito con pomolo Ø60 in porcellana Coat hook with round knob Ø60 in porcelain		•	•	4

acciaio inox
stainless steel



REGI
inox
REGI

art. 171 ALISE'

design: Studio Reguitti
materiale: Acciaio Inox
material: Solid Stainless Steel

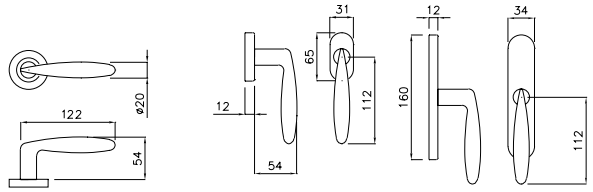

171 MR 006



171 MR 008



171 MR 009



171 MP 702



171 SE 160
171 SG 160







171 DK 015

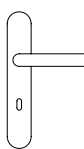
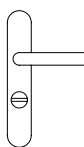

MANIGLIA CON PLACCA / LEVER HANDLE ON PLATE

	171 MP 702	Maniglia con placca Lever Handle on plate	702 mm 226x42	con molla e grano with spring and grub screw	•	1
	171 PW 702	Maniglia con placca Lever Handle on plate	702 mm 226x42	con WC 513 con molla e grano with WC turn 513 with spring and grub screw	•	1

MANIGLIA CON ROSETTA / LEVER HANDLE ON ROSE

	171 MR 006	Maniglia con rosetta Lever Handle on rose	006 mm Ø50x8	tipo lusso con molla e grano lusso type with spring and grub screw	•	1
	171 MR 008	Maniglia con rosetta Lever Handle on rose	008 mm Ø50x8	con molla e grano with spring and grub screw	•	1
	171 MR 009	Maniglia con rosetta Lever Handle on rose	009 mm Ø62x32	ovale con molla e grano oval with spring and grub screw	•	1
	171 RW 006	Maniglia con rosetta Lever Handle on rose	006 mm Ø50x8	tipo lusso con WC 503 lusso type with WC turn 503	•	1
	171 RW 008	Maniglia con rosetta Lever Handle on rose	008 mm Ø50x8	con WC 503 with WC turn 503	•	1

CREMONESE / WINDOW HANDLE WITH MECHANISM

	171 SG 160*	Cremonese con placca Window Handle on plate	160 mm 160x34	coprivite con gioco with cover-screw plate with mechanism	•	2
--	-------------	--	---------------	--	---	---

MARTELLINA / WINDOW HANDLE WITHOUT MECHANISM

	171 SE 160*	Martellina con placca Window Handle on plate	160 mm 160x34	coprivite q.7 with cover-screw plate with square-pin mm 7	•	2
---	-------------	---	---------------	--	---	---

DREH KIPP / DREH KIPP

	171 DK 015	Dreh Kipp con rosetta Dreh Kipp on rose	015 mm 65x31	con movimento in metallo with metal mechanism	•	3
	171 DK C15	Dreh Kipp con rosetta Dreh Kipp on rose	C15 mm 102x31	con movimento con chiave with metal mechanism with key	•	2

* Placca adatta a movimenti intercambiabili
Plate suitable to interchangeable movements



171 RW 006



171 RW 008

A RICHIESTA / ON REQUEST:

- Mezza maniglia con placca o con rosetta (specificare se destra o sinistra) / Half lever handle on plate or on rose (to specify if right or left)
- Maniglia con rosette senza bocchette / Lever handle on rose without rose for key
- Coppie impugnature (CM) con grano e ferro senza rosette e senza bocchette / Pair levers (CM) with grub screws and square pin without rose and without rose for key

art. 701 JAVA

design: Studio Reguitti
materiale: Acciaio Inox
material: Stainless Steel

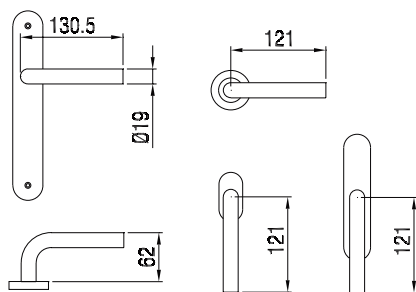

701 MR 006



701 MR 008



701 MR 009



701 MP 702



701 SE 160
701 SG 160



701 DK 015



MANIGLIA CON PLACCA / LEVER HANDLE ON PLATE

	701 MP 702 Maniglia con placca Lever Handle on plate	702 mm 226x42	con molla e grano with spring and grub screw	•	1
	701 PW 702 Maniglia con placca Lever Handle on rose	702 mm 226x42	con WC 503 con molla e grano with WC turn 503 with spring and grub screw	•	1

MANIGLIA CON ROSETTA / LEVER HANDLE ON ROSE

	701 MR 006 Maniglia con rosetta Lever Handle on rose	006 mm Ø50x8	tipo lusso con molla e grano lusso type with spring and grub screw	•	1
	701 MR 008 Maniglia con rosetta Lever Handle on rose	008 mm Ø50x8	con molla e grano with spring and grub screw	•	4
	701 MR 009 Maniglia con rosetta Lever Handle on rose	009 mm Ø62x32	ovale con molla e grano oval with spring and grub screw	•	1
	701 MR 916 Maniglia con rosetta Lever Handle on rose	916 mm 62x32	ovale con molla e grano oval with spring and grub screw	•	1
	701 RW 006 Maniglia con rosetta Lever Handle on rose	006 mm Ø50x8	tipo lusso con WC 503 lusso type with WC turn 503	•	1
	701 RW 008 Maniglia con rosetta Lever Handle on rose	008 mm Ø50x8	con WC 503 with WC turn 503	•	1

CREMONESE / WINDOW HANDLE WITH MECHANISM

	701 SG 160* Cremonese con placca Window Handle on plate	160 mm 160x34	coprivite con gioco with cover-screw plate with mechanism	•	2
--	--	---------------	--	---	---

MARTELLINA / WINDOW HANDLE WITHOUT MECHANISM

	701 SE 160* Martellina con placca Window Handle on plate	160 mm 160x34	coprivite q.7 with cover-screw plate with square-pin mm 7	•	2
--	---	---------------	--	---	---

DREH KIPP / DREH KIPP

	701 DK 015 Dreh Kipp con rosetta Dreh Kipp on rose	015 mm 65x31	con movimento in metallo with metal mechanism	•	2
	701 DK C15 Dreh Kipp con rosetta Dreh Kipp on rose	C15 mm 102x31	con movimento con chiave with metal mechanism with key	•	2

* Placca adatta a movimenti intercambiabili
Plate suitable to interchangeable movements



701 DK C15

A RICHIESTA / ON REQUEST:

- Mezza maniglia con placca o con rosetta (specificare se destra o sinistra) / Half lever handle on plate or on rose (to specify if right or left)
- Maniglia con rosette senza bocchette / Lever handle on rose without rose for key
- Coppie impugnature (CM) con grano e ferro senza rosette e senza bocchette / Pair levers (CM) with grub screws and square pin without rose and without rose for key

art.702 ELLE

design: Studio Reguitti
materiale: Acciaio Inox
material: Stainless Steel

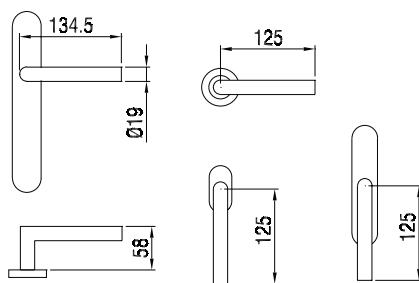

702 MR 006



702 MR 008



702 MR 009



702 MP 702



702 SE 160
702 SG 160



702 DK 015



MANIGLIA CON PLACCA / LEVER HANDLE ON PLATE

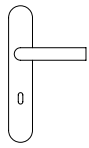

702 MP 702 Maniglia con placca 702 mm 226x42 con molla e grano
Lever Handle on plate with spring and grub screw

•

1

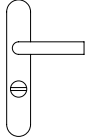

702 PW 702 Maniglia con placca 702 mm 226x42 con WC 503 con molla e grano
Lever Handle on plate with WC turn 503 with spring and grub screw

•

1

MANIGLIA CON ROSETTA / LEVER HANDLE ON ROSE



702 MR 006 Maniglia con rosetta 006 mm Ø50x8 tipo lusso con molla e grano
Lever Handle on rose lusso type with spring and grub screw

•

1



702 MR 008 Maniglia con rosetta 008 mm Ø50x8 con molla e grano
Lever Handle on rose with spring and grub screw

•

4

702 MR 009 Maniglia con rosetta 009 mm Ø62x32 ovale con molla e grano
Lever Handle on rose oval with spring and grub screw

•

1



702 MR 916 Maniglia con rosetta 916 mm 62x32 ovale con molla e grano
Lever Handle on rose oval with spring and grub screw

•

1



702 RW 006 Maniglia con rosetta 006 mm Ø50x8 tipo lusso con WC 503
Lever Handle on rose lusso type with WC turn 503

•

1



702 RW 008 Maniglia con rosetta 008 mm Ø50x8 con WC 503
Lever Handle on rose with WC turn 503

•

1

CREMONESE / WINDOW HANDLE WITH MECHANISM

702 SG 160* Cremonese con placca 160 mm 160x34 coprivite con gioco
Window Handle on plate with cover-screw plate with mechanism

•

2

MARTELLINA / WINDOW HANDLE WITHOUT MECHANISM



702 SE 160* Martellina con placca 160 mm 160x34 coprivite q.7
Window Handle on plate with cover-screw plate with square-pin mm 7

•

2

DREH KIPP / DREH KIPP

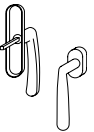

702 DK 015 Dreh Kipp con rosetta 015 mm 65x31 con movimento in metallo
Dreh Kipp on rose with metal mechanism

•

2

702 DK C15 Dreh Kipp con rosetta C15 mm 102x31 con movimento con chiave
Dreh Kipp on rose with metal mechanism with key

•

2

* Placca adatta a movimenti intercambiabili
Plate suitable to interchangeable movements

A RICHIESTA / ON REQUEST:

- Mezza maniglia con placca o con rosetta (specificare se destra o sinistra) / Half lever handle on plate or on rose (to specify if right or left)
- Maniglia con rosette senza bocchette / Lever handle on rose without rose for key
- Coppie impugnature (CM) con grano e ferro senza rosette e senza bocchette / Pair levers (CM) with grub screws and square pin without rose and without rose for key

art.703 USA

design: Studio Reguitti
materiale: Acciaio Inox
material: Stainless Steel

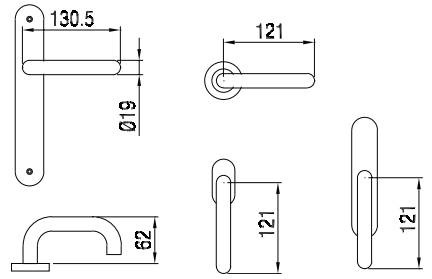

703 MR 006



703 MR 008



703 MR 009



703 MP 702



703 SE 160
703 SG 160



703 DK 015



MANIGLIA CON PLACCA / LEVER HANDLE ON PLATE

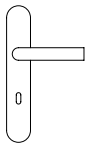

703 MP 702 Maniglia con placca 702 mm 226x42 con molla e grano
Lever Handle on plate with spring and grub screw

•

1

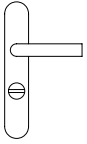

703 PW 702 Maniglia con placca 702 mm 226x42 con WC 503 con molla e grano
Lever Handle on plate with WC turn 503 with spring and grub screw

•

1

MANIGLIA CON ROSETTA / LEVER HANDLE ON ROSE



703 MR 006 Maniglia con rosetta 006 mm Ø50x8 tipo lusso con molla e grano
Lever Handle on rose lusso type with spring and grub screw

•

1



703 MR 008 Maniglia con rosetta 008 mm Ø50x8 con molla e grano
Lever Handle on rose with spring and grub screw

•

4

703 MR 009 Maniglia con rosetta 009 mm Ø62x32 ovale con molla e grano
Lever Handle on rose oval with spring and grub screw

•

1



703 MR 916 Maniglia con rosetta 916 mm 62x32 ovale con molla e grano
Lever Handle on rose oval with spring and grub screw

•

1



703 RW 006 Maniglia con rosetta 006 mm Ø50x8 tipo lusso con WC 503
Lever Handle on rose lusso type with WC turn 503

•

1



703 RW 008 Maniglia con rosetta 008 mm Ø50x8 con WC 503
Lever Handle on rose with WC turn 503

•

1

CREMONESE / WINDOW HANDLE WITH MECHANISM

703 SG 160* Cremonese con placca 160 mm 160x34 coprivite con gioco
Window Handle on plate with cover-screw plate with mechanism

•

2

MARTELLINA / WINDOW HANDLE WITHOUT MECHANISM



703 SE 160* Martellina con placca 160 mm 160x34 coprivite q.7
Window Handle on plate with cover-screw plate with square-pin mm 7

•

2

DREH KIPP / DREH KIPP

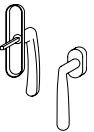

703 DK 015 Dreh Kipp con rosetta 015 mm 65x31 con movimento in metallo
Dreh Kipp on rose with metal mechanism

•

2

703 DK C15 Dreh Kipp con rosetta C15 mm 102x31 con movimento con chiave
Dreh Kipp on rose with metal mechanism with key

•

2

* Placca adatta a movimenti intercambiabili
Plate suitable to interchangeable movements



703 PW 702

A RICHIESTA / ON REQUEST:

- Mezza maniglia con placca o con rosetta (specificare se destra o sinistra) / Half lever handle on plate or on rose (to specify if right or left)
- Maniglia con rosette senza bocchette / Lever handle on rose without rose for key
- Coppie impugnature (CM) con grano e ferro senza rosette e senza bocchette / Pair levers (CM) with grub screws and square pin without rose and without rose for key

art. 702 Q-ELLE

design: Studio Reguitti
materiale: Acciaio Inox
material: Stainless Steel

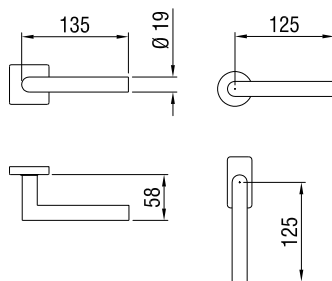

702 MR Q86 INOX SAT.



702 DK Q15 INOX SAT.



Q08 BY



Q08 BN



Q09 BY



Q09 BN



702 MR 9Q6 INOX SAT.

VERSIONI / VERSIONS





Finiture
Finishes

INOX SAT.



MANIGLIA SU ROSETTA QUADRATA / LEVER HANDLE ON SQUARE ROSE

	702 MR Q86	Maniglia con rosetta Lever Handle on rose	Q86	mm 50X50	con molla e grano with spring and grub screw	•	1
	702 MR 9Q6	Maniglia con rosetta Lever Handle on rose	9Q6	mm 61X31	con molla e grano with spring and grub screw	•	1

DREH KIPP / DREH KIPP

702 DK Q15	Dreh Kipp con rosetta Dreh Kipp on rose	Q15	mm 65x31	con movimento in metallo with metal mechanism	•	2
------------	--	-----	----------	--	---	---

BOCCHETTE / KEY ROSES

Q08 BN - Q08 BY	Bocchetta quadrata coprivite mm 50x50 Square cover screw key rose mm 50x50	•	24
-----------------	---	---	----

Q09 BN - Q09 BY	Bocchetta rettangolare coprivite mm 61x31 Rectangular cover screw key rose mm 61x31	•	24
-----------------	--	---	----

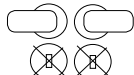

Detrazione per maniglie senza bocchetta Q08
Amount to deduct for handles without rose for key Q08

Detrazione per maniglie senza bocchetta Q09
Amount to deduct for handles without rose for key Q09

A RICHIESTA / ON REQUEST:

- Mezza maniglia con placca o con rosetta (specificare se destra o sinistra) / Half lever handle on plate or on rose (to specify if right or left)
- Maniglia con rosette senza bocchette / Lever handle on rose without rose for key
- Coppie impugnature (CM) con grano e ferro senza rosette e senza bocchette / Pair levers (CM) with grub screws and square pin without rose and without rose for key

art. 704 BIONIC

materiale: Acciaio Inox
material: Stainless Steel

Impugnatura AISI 316
Lever AISI 316



reddot design award
winner 2011

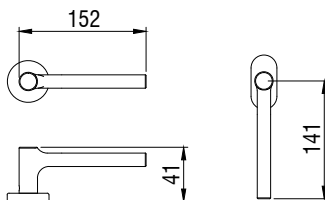

704 MR 816 INOX SAT.



704 DK 015 INOX SAT.



704 MR 916 INOX SAT.

VERSIONI / VERSIONS



Finiture
Finishes

INOX SAT.



MANIGLIA SU ROSETTA / LEVER HANDLE ON ROSE

	704 MR 816	Maniglia con rosetta Lever Handle on rose	816	mm Ø 50	con molla e grano with spring and grub screw	•	1
	704 MR 916	Maniglia con rosetta Lever Handle on rose	916	mm 62x32	con molla e grano with spring and grub screw	•	1
	704 RW 816	Maniglia con rosetta Lever Handle on rose	816	mm Ø 50	con wc 503 with wc turn 503	•	1
	704 RW 916	Maniglia con rosetta Lever Handle on rose	916	mm 62x32	con wc 503 with wc turn 503	•	1
DREH KIPP / DREH KIPP							
	704 DK 015	Dreh Kipp con rosetta Dreh Kipp on rose	015	mm 62x32	con movimento in metallo with metal mechanism	•	2

A RICHIESTA / ON REQUEST:

- Mezza maniglia con placca o con rosetta (specificare se destra o sinistra) / Half lever handle on plate or on rose (to specify if right or left)
- Maniglia con rosette senza bocchette / Lever handle on rose without rose for key
- Coppie impugnature (CM) con grano e ferro senza rosette e senza bocchette / Pair levers (CM) with grub screws and square pin without rose and without rose for key

art. 705 JET

materiale: Acciaio Inox
material: Stainless Steel

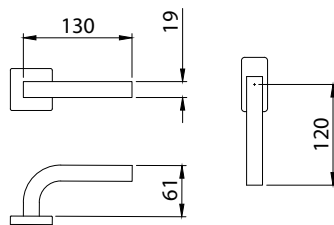

705 MR Q86 INOX SAT.



705 MR 9Q6 INOX SAT.



705 DK Q15 INOX SAT.

VERSIONI / VERSIONS



Finiture
Finishes

MANIGLIA SU ROSETTA QUADRATA / LEVER HANDLE ON SQUARE ROSE						INOX SAT.	
	705 MR Q86	Maniglia con rosetta Lever Handle on rose	Q86	mm 50X50	con molla e grano with spring and grub screw	•	1
	705 MR 9Q6	Maniglia con rosetta Lever Handle on rose	9Q6	mm 61x31	con molla e grano with spring and grub screw	•	1
DREH KIPP / DREH KIPP							
	705 DK Q15	Dreh Kipp con rosetta Dreh Kipp on rose	Q15	mm 65x31	con movimento in metallo with metal mechanism	•	2

A RICHIESTA / ON REQUEST:

- Mezza maniglia con placca o con rosetta (specificare se destra o sinistra) / Half lever handle on plate or on rose (to specify if right or left)
- Maniglia con rosette senza bocchette / Lever handle on rose without rose for key
- Coppie impugnature (CM) con grano e ferro senza rosette e senza bocchette / Pair levers (CM) with grub screws and square pin without rose and without rose for key

art. Q19 Q-INOX

materiale: Acciaio Inox
material: Stainless Steel

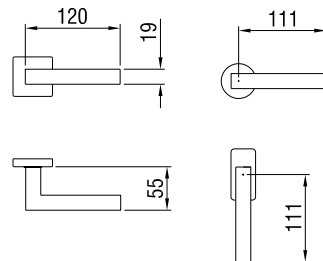

Q19 MR Q86 INOX SAT.



Q19 MR 9Q6 INOX SAT.



Q19 DK C15 INOX SAT.

Q19 DK Q15 INOX SAT.



503 NO QN6

VERSIONI / VERSIONS



MANIGLIA SU ROSETTA QUADRATA / LEVER HANDLE ON SQUARE ROSE

	Q19 MR Q86	Maniglia con rosetta Lever Handle on rose	Q86	mm 50X50	con molla e grano with spring and grub screw	•	1
	Q19 MR 9Q6	Maniglia con rosetta Lever Handle on rose	9Q6	mm 61X31	con molla e grano with spring and grub screw	•	1

DREH KIPP / DREH KIPP

Q19 DK Q15	Dreh Kipp con rosetta Dreh Kipp on rose	Q15	mm 65x31	con movimento in metallo with metal mechanism	•	2
Q19 DK C15	Dreh Kipp con rosetta Dreh Kipp on rose	C15	mm 102x31	con movimento in metallo with metal mechanism	•	2

NOTTOLINO LIBERO/OCCUPATO PER WC / WC TURN AND RELEASE

503 NO QN6	Nottolino libero/occupato per wc con rosetta quadrata QN6 mm 50x50 WC turn and release on square rose QN6 mm 50x50				•	6
------------	---	--	--	--	---	---

A RICHIESTA / ON REQUEST:

- Mezza maniglia con placca o con rosetta (specificare se destra o sinistra) / Half lever handle on plate or on rose (to specify if right or left)
- Maniglia con rosette senza bocchette / Lever handle on rose without rose for key
- Coppie impugnature (CM) con grano e ferro senza rosette e senza bocchette / Pair levers (CM) with grub screws and square pin without rose and without rose for key

ACCIAIO INOX / STAINLESS STEEL



Specificare destro o sinistro per la maniglia interna
Please specify if inside lever handle is right or left

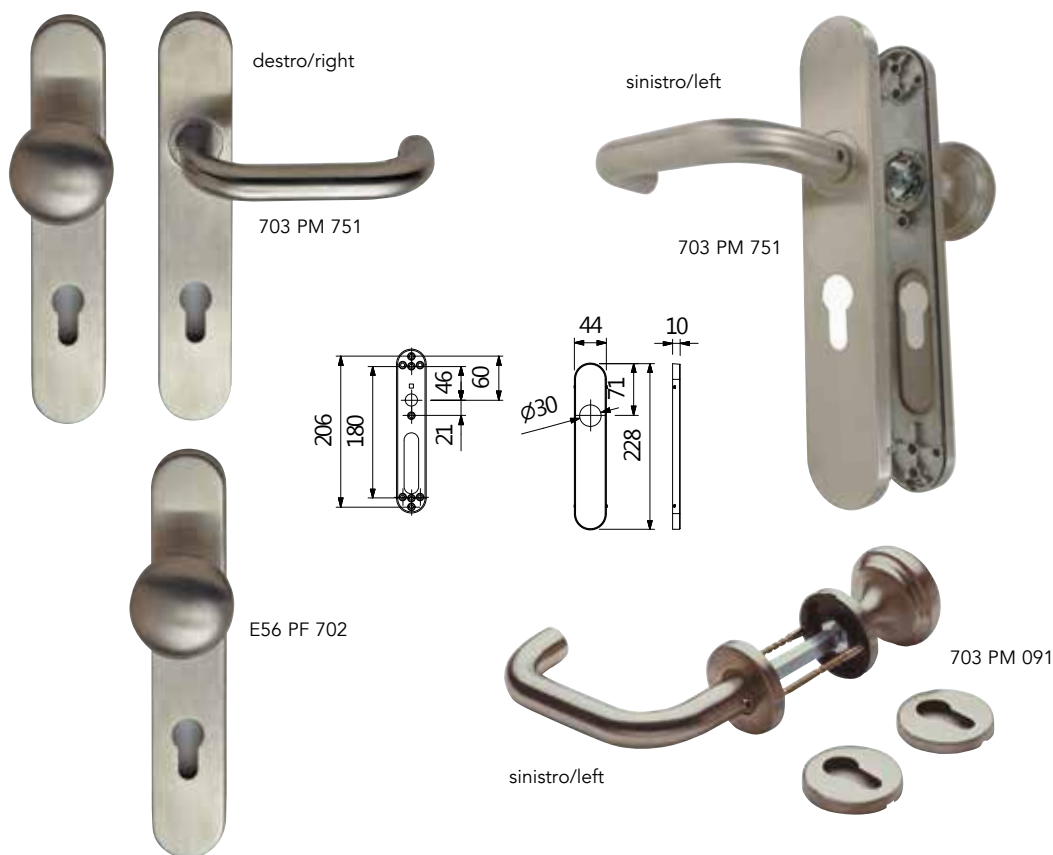

VERSIONI / VERSIONS



Finiture
Finishes

		FINITURA	€	
701 PM 751	Maniglia art. 701 con molla, con pomolo art. 56 Ø60 fisso su placca 702 yale Lever art. 701 with spring, with fixed knob art. 56 Ø60 on plate 702 w/europrofile cylinder hole	INOX SAT	•	1
702 PM 751	Maniglia art. 702 con molla, con pomolo art. 56 Ø60 fisso su placca 702 yale Lever art. 702 with spring, with fixed knob art. 56 Ø60 on plate 702 w/europrofile cylinder hole	INOX SAT	•	1
703 PM 751	Maniglia art. 703 con molla, con pomolo art. 56 Ø60 fisso su placca 702 yale Lever art. 703 with spring, with fixed knob art. 56 Ø60 on plate 702 w/europrofile cylinder hole	INOX SAT	•	1
171 PM 751	Maniglia art. 171 con molla, con pomolo art. 56 Ø60 fisso su placca 702 yale Lever art. 171 with spring, with fixed knob art. 56 Ø60 on plate 702 w/europrofile cylinder hole	INOX SAT	•	1
701 PM 091	Man. art. 701 c/ros. 008 c/molla e grano, c/pom art.56Ø60 fisso su rosetta P08, c/ferro F2, c/bocchetta yale. Lever handle art. 701 with rose 008 with spring and grub screw, fixed knob art.56Ø60 on rose P08, with square pin F2, with europrofile cylinder key rose.	INOX SAT	•	1
702 PM 091	Man. art. 702 c/ros. 008 c/molla e grano, c/pom art.56Ø60 fisso su rosetta P08, c/ferro F2, c/bocchetta yale. Lever handle art. 702 with rose 008 with spring and grub screw, fixed knob art.56Ø60 on rose P08, with square pin F2, with europrofile cylinder key rose.	INOX SAT	•	1
703 PM 091	Man. art. 703 c/ros. 008 c/molla e grano, c/pom art.56Ø60 fisso su rosetta P08, c/ferro F2, c/bocchetta yale. Lever handle art. 703 with rose 008 with spring and grub screw, fixed knob art.56Ø60 on rose P08, with square pin F2, with europrofile cylinder key rose.	INOX SAT	•	1
171 PM 091	Man. art. 171 c/ros. 008 c/molla e grano, c/pom art.56Ø60 fisso su rosetta P08, c/ferro F2, c/bocchetta yale. Lever handle art. 171 with rose 008 with spring and grub screw, fixed knob art.56Ø60 on rose P08, with square pin F2, with europrofile cylinder key rose.	INOX SAT	•	4
E56 PF 702	Pomolo fisso art. 56 Ø60 con placca 702 yale. Fixed knob art. 56 Ø60 on plate 702 with europrofile cylinder hole.			



VERSIONI / VERSIONS



Finiture
Finishes

		FINITURA	€	
006 BY***	Bocchetta coprivite tipo lusso Ø50 foro yale Cover screw key rose lusso type Ø50 with europrofile profile cylinder hole	INOX SAT	•	24
006 BW***	Bocchetta coprivite tipo lusso Ø50 foro union 32x18 Cover screw key rose lusso type Ø50 with union hole	INOX SAT	•	24
008 BY***	Bocchetta coprivite Ø50 foro yale Cover screw key rose Ø50 with europrofile cylinder hole	INOX SAT	•	24
009 BY***	Bocchetta ovale coprivite mm 62x32 foro yale Cover screw oval key rose mm 62x32 with europrofile cylinder hole	INOX SAT	•	24
C59 PF R50	Pomolo fisso art. 59 Ø50 con rosetta R50 mm Ø50x9 con piastrina Fixed knob art. 59 Ø50 on rose R50 mm Ø50x9 with fixing base	INOX SAT	•	4
C59 PF 702	Pomolo fisso art. 59 Ø50 con placca 702 yale. Fixed knob art. 59 Ø50 on plate 702 with europrofile cylinder hole.	INOX SAT	•	4
C59 PR 008	Coppia Pomolo art. 59 Ø50 con rosetta 008 mm Ø50x8 Pair knob art. 59 Ø50 on rose 008 mm Ø50x8	INOX SAT	•	2

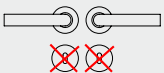

- * Detrazione per maniglia con rosetta 006 senza bocchetta
Amount to deduct for lever on rose 006 without key hole € 9,92
- ** Detrazione per maniglia con rosetta 008 senza bocchetta
Amount to deduct for lever on rose 008 without key hole € 3,48
- *** Detrazione per maniglia con rosetta 009 senza bocchetta
Amount to deduct for lever on rose 009 without key hole € 5,36

ACCIAIO INOX / STAINLESS STEEL



503 NO 006

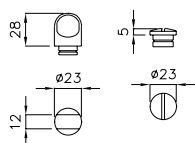

203 FE

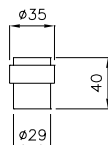

204 FE

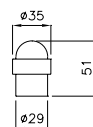

535 PI 001



Q35 PI 002



729 TP 00S



729 TP 00F



729 TP 00M



729 TP 00X



VERSIONI / VERSIONS



Finiture
Finishes

		FINITURA	€	
535 PI 001	Placca incasso coprivite con foro chiave Cover screw sliding door plate with key hole	INOX SAT	•	16
535 PI 002	Placca incasso cieca Cover screw sliding door blind plate	INOX SAT	•	16
Q35 PI 001	Placca incasso rettangolare coprivite con foro chiave Rectangular cover screw sliding door plate with key hole	INOX SAT	•	16
Q35 PI 002	Placca incasso rettangolare cieca Blind rectangular cover screw sliding door plate	INOX SAT	•	16
503 NO 006	Nottolino libero/occupato per wc con rosetta coprivite tipo lusso Ø50x8 Turn wc on cover screw rose Ø50x8 lusso type	INOX SAT	•	6
503 NO 008	Nottolino libero/occupato per wc con rosetta coprivite Ø50x8 Turn wc on cover screw rose Ø50x8	INOX SAT	•	6
203 FE	Fermaporte a pavimento Door stop - floor mounted type	INOX SAT	•	10
204 FE	Fermaporte a pavimento Door stop - floor mounted type	INOX SAT	•	10
729 TP 00M	Targhetta Ø76x1,5 con pittogramma - uomo Symbol plate Ø76x1,5 with pictogram - man	INOX SAT	•	12
729 TP 00F	Targhetta Ø76x1,5 con pittogramma - donna Symbol plate Ø76x1,5 with pictogram - woman	INOX SAT	•	12
729 TP 00S	Targhetta Ø76x1,5 con pittogramma - no smoking Symbol plate Ø76x1,5 with pictogram - no smoking	INOX SAT	•	12
729 TP 00X	Targhetta Ø76x1,5 con pittogramma - handicap Symbol plate Ø76x1,5 with pictogram - handicap	INOX SAT	•	12

alluminio

aluminium



art. **20** ALICE

materiale: Alluminio
material: Aluminium

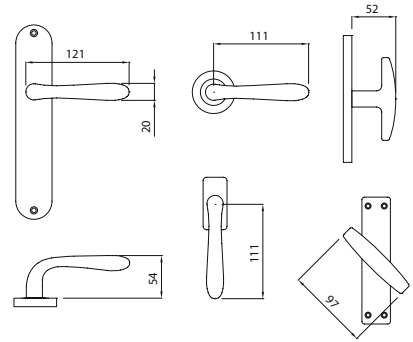

20 CM-AA



20 CM-AB



20DK023-AB



20DK023-AA



20MR003-AA



20MR009-AA









20MP022-AA

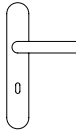
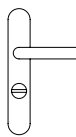

20CR021-AA
20MA021-AA

VERSIONI / VERSIONS

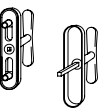

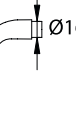
					AB BRONZO F4	AA ARGENTO F1	AO ORO F3	
MANIGLIA CON PLACCA / LEVER HANDLE ON PLATE								
	20 MP 022	Maniglia con placca Lever Handle on plate	022 mm 228x42	con grano with grub screw	•	•		10
	20 PG 022	Maniglia con placca Lever Handle on plate	022 mm 228x42	con grano con nottolino WC with grub screw and WC turn	•	•		6
MANIGLIA CON ROSETTA / LEVER HANDLE ON ROSE								
	20 MR 003	Maniglia con rosetta Lever Handle on rose	003 mm Ø45x7	con grano with grub screw	•	•		5
	20 MR 008	Maniglia con rosetta Lever Handle on rose	008 mm Ø50x8	con grano with grub screw	•	•	•	5
	20 MR 009	Maniglia con rosetta Lever Handle on rose	009 mm 62x32	ovale con grano oval with grub screw	•	•	•	5
	20 RG F08	Maniglia con rosetta Lever Handle on rose	F08 mm Ø50x8	con nottolino WC with WC turn 498	•	•		5
CREMONESE / WINDOW HANDLE WITH MECHANISM MARTELLINA / WINDOW HANDLE WITHOUT MECHANISM								
	20 CR 021	Cremonese con placca Window Handle on plate	021 mm 149x34	con fori viti con gioco with holes for screws with mechanism	•	•		8
	20 MA 021	Martellina con placca Window Handle on plate	021 mm 149x34	q.7 senza gioco without mechanism square-pin mm 7	•	•		8
DREH KIPP / DREH KIPP								
	20 DK 023	Dreh Kipp con rosetta Dreh Kipp on rose	023 mm 64x28	q.7 x37 con bussole q.7 x37 with bushes	•	•		10
IMPUGNATURA / LEVER HANDLE								
	20 CM	Coppia impugnatura q.8 con grano con imposta ø16 Pair Lever Handle q.8 with grub screw-neck size ø16			•	•	•	8
	20 IP	Solo impugnatura c/foro grano M6 in testa e foro q.8 con imposta ø16 Lever Handle only q.8 w.grub screw M6-front position-neck size ø16			•	•		

A RICHIESTA / ON REQUEST:

- Mezza maniglia con placca o con rosetta (specificare se destra o sinistra) / Half lever handle on plate or on rose (to specify if right or left)
- Maniglia con rosette senza bocchette / Lever handle on rose without rose for key

art. **21** ALFA

materiale: Alluminio
material: Aluminium

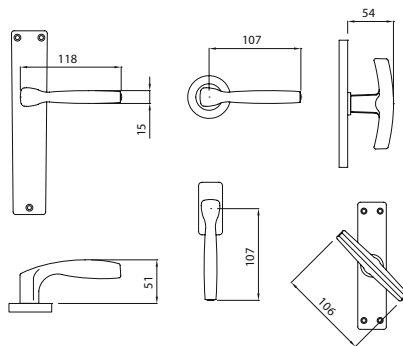

21CM-AB



21CM-AO



21CM-AA



21MR008-AB



21MR009-AB



21CR021-AB
21MA021-AB



21DK021-AB

VERSIONI / VERSIONS



				AB BRONZO F4	AA ARGENTO F1	AO ORO F3	
MANIGLIA CON PLACCA / LEVER HANDLE ON PLATE							
	21 MP 021	Maniglia con placca Lever Handle on plate	021 mm 216x42x38	con grano with grub screw	•	•	10
MANIGLIA CON ROSETTA / LEVER HANDLE ON ROSE							
	21 MR 008	Maniglia con rosetta Lever Handle on rose	008 mm Ø50x8	con grano with grub screw	•	•	5
	21 MR 009	Maniglia con rosetta Lever Handle on rose	009 mm 62x32	ovale con grano oval grub screw	•	•	5
	21 RG F08	Maniglia con rosetta Lever Handle on rose	F08 mm Ø50x8	con nottolino WC with WC turn 498	•	•	5
CREMONESE / WINDOW HANDLE WITH MECHANISM MARTELLINA / WINDOW HANDLE WITHOUT MECHANISM							
	21 CR 021	Cremonese con placca Window Handle on plate	021 mm 149x34	con fori viti con gioco with holes for screws with mechanism	•	•	8
	21 MA 021	Martellina con placca Window Handle on plate	021 mm 149x34	q.7 senza gioco without mechanism square-pin mm 7	•	•	8
DREH KIPP / DREH KIPP							
	21 DK 021	Dreh Kipp con rosetta Dreh Kipp on rose	021 mm 62x28	q.7 x37 con bussole q.7 x37 with bushes	•	•	10
IMPUGNATURA / LEVER HANDLE							
	21 CM	Coppia impugnatura q.8 con grano con imposta ø18 Pair Lever Handle q.8 with grub screw-neck size ø18			•	•	8
	21 IP	Solo impugnatura c/foro grano M6 in testa e foro q.8 con imposta ø18 Lever Handle only q.8 w.grub screw M6-front position-neck size ø18			•	•	



21MP021-AB

A RICHIESTA / ON REQUEST:

- Mezza maniglia con placca o con rosetta (specificare se destra o sinistra) / Half lever handle on plate or on rose (to specify if right or left)
- Maniglia con rosette senza bocchette / Lever handle on rose without rose for key

art. 22 ALTEA

materiale: Alluminio
material: Aluminium

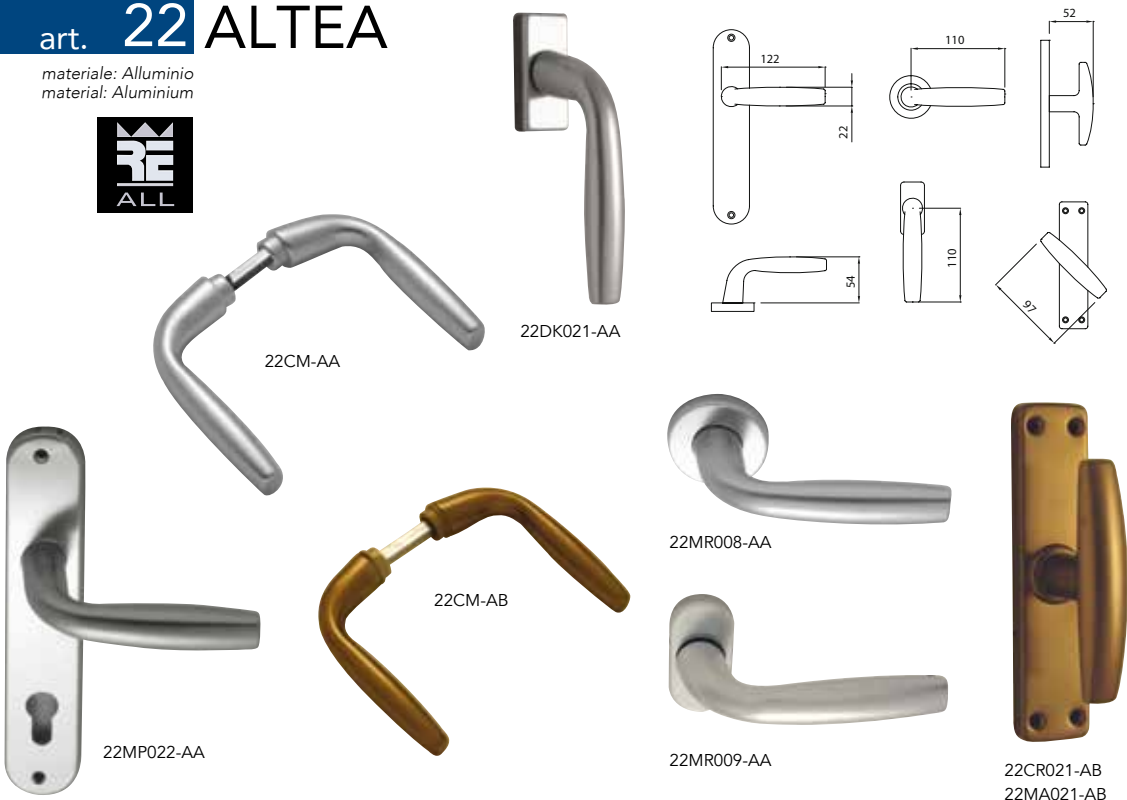

22CM-AA

22DK021-AA

22MR008-AA

22CM-AB

22MR009-AA

22MP022-AA

22CR021-AB
22MA021-AB

VERSIONI / VERSIONS



Finiture
Finishes

AB
BRONZO
F4

AA
ARGENTO
F1



MANIGLIA CON PLACCA / LEVER HANDLE ON PLATE

	22 MP 022	Maniglia con placca Lever Handle on plate	022 mm 228x42	con grano with grub screw	•	•	10
--	-----------	--	---------------	------------------------------	---	---	----

MANIGLIA CON ROSETTA / LEVER HANDLE ON ROSE

	22 MR 008	Maniglia con rosetta Lever Handle on rose	008 mm Ø50x8	con grano with grub screw	•	•	5
	22 MR 009	Maniglia con rosetta Lever Handle on rose	009 mm 62x32	ovale con grano oval with grub screw	•	•	5

CREMONESE / WINDOW HANDLE WITH MECHANISM MARTELLINA / WINDOW HANDLE WITHOUT MECHANISM

	22 CR 021	Cremonese con placca Window Handle on plate	021 mm 149x34	con fori viti con gioco with holes for screws with mechanism	•	•	8
	22 MA 021	Martellina con placca Window Handle on plate	021 mm 149x34	q.7 senza gioco without mechanism square-pin mm 7	•	•	8

DREH KIPP / DREH KIPP

	22 DK 021	Dreh Kipp con rosetta Dreh Kipp on rose	021 mm 62x28	q.7 x37 con bussole q.7 x37 with bushes	•	•	10
--	-----------	--	--------------	--	---	---	----

IMPUGNATURA / LEVER HANDLE

	22 CM	Coppia impugnatura q.8 con grano con imposta ø18 Pair Lever Handle q.8 with grub screw-neck size ø18			•	•	8
	22 IP	Solo impugnatura c/foro grano M6 in testa e foro q.8 con imposta ø18 Lever Handle only q.8 w.grub screw M6-front position-neck size ø18			•	•	

Possibile avere maniglia con placca montata - EXTRA d 0,40 a coppia.

A RICHIESTA / ON REQUEST:

- Mezza maniglia con placca o con rosetta (specificare se destra o sinistra) / Half lever handle on plate or on rose (to specify if right or left)
- Maniglia con rosette senza bocchette / Lever handle on rose without rose for key

art. 23 ALEXIA

materiale: Alluminio
material: Aluminium



23CM-AA



23MR008-AA



23MR009-AB

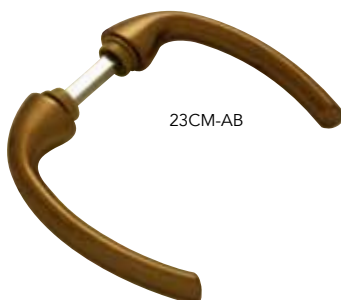

23CM-AB



23DK023-AA



23CR021-AB
23MA021-AB

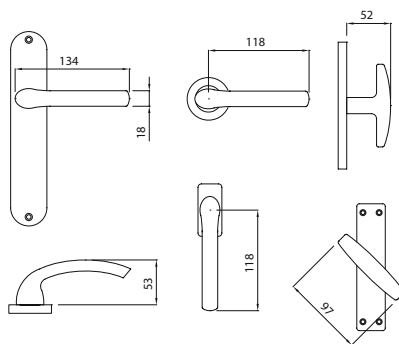

VERSIONI / VERSIONS



Finiture
Finishes

AB
BRONZO
F4

AA
ARGENTO
F1



MANIGLIA CON ROSETTA / LEVER HANDLE ON ROSE

	23 MR 008	Maniglia con rosetta Lever Handle on rose	008 mm Ø50x8	con grano with grub screw	•	•	5
	23 MR 009	Maniglia con rosetta Lever Handle on rose	009 mm 62x32	ovale con grano oval with grub screw	•	•	5

CREMONESE / WINDOW HANDLE WITH MECHANISM MARTELLINA / WINDOW HANDLE WITHOUT MECHANISM

	23 CR 021	Cremonese con placca Window Handle on plate	021 mm 149x34	con fori viti con gioco with holes for screws with mechanism	•	•	8
	23 MA 021	Martellina con placca Window Handle on plate	021 mm 149x34	q.7 senza gioco without mechanism square-pin mm 7	•	•	8

DREH KIPP / DREH KIPP

	23 DK 023	Dreh Kipp con rosetta Dreh Kipp on rose	023 mm 64x28	q.7 x37 con bussole q.7 x37 with bushes		•	10
--	-----------	--	--------------	--	--	---	----

IMPUGNATURA / LEVER HANDLE

23 CM	Coppia impugnatura q.8 con grano con imposta ø18 Pair Lever Handle q.8 with grub screw-neck size ø18	•	•	8
23 IP	Solo impugnatura c/foro grano M6 in testa e foro q.8 con imposta ø18 Lever Handle only q.8 w.grub screw M6-front position-neck size ø18	•	•	

Possibile avere maniglia con placca montata - EXTRA d 0,40 a coppia

A RICHIESTA / ON REQUEST:

- Mezza maniglia con placca o con rosetta (specificare se destra o sinistra) / Half lever handle on plate or on rose (to specify if right or left)
- Maniglia con rosette senza bocchette / Lever handle on rose without rose for key

art. B25 ALBA

materiale: Alluminio
material: Aluminium

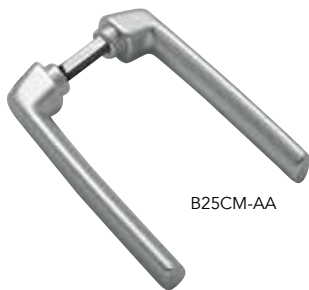

B25CM-AA



B25CM-AB

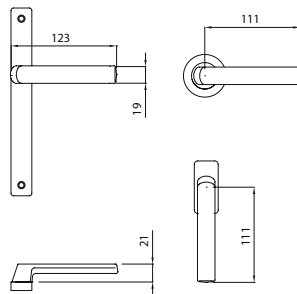

B25MR008-AB



B25DK023-AB



B25MP021-AB



B25MPB25-AB



B25MR009-AA

VERSIONI / VERSIONS



Finiture
Finishes

AB
BRONZO
F4

AA
ARGENTO
F1



MANIGLIA CON PLACCA / LEVER HANDLE ON PLATE

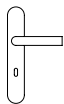

B25 MP 021 Maniglia con placca 021 mm 216x42x38 con grano
Lever Handle on plate with grub screw

B25 MP B25 Maniglia con placca B25 mm 220x25 con grano
Lever Handle on plate with grub screw

MANIGLIA CON ROSETTA / LEVER HANDLE ON ROSE



B25 MR 008 Maniglia con rosetta 008 mm Ø50x8 con grano
Lever Handle on rose with grub screw



B25 MR 009 Maniglia con rosetta 009 mm 62x32 ovale con grano
Lever Handle on rose oval with grub screw

DREH KIPP / DREH KIPP



B25 DK 023 Dreh Kipp con rosetta 023 mm 64x28 q.7 x37 con bussole
Dreh Kipp on rose q.7 x37 with bushes

IMPUGNATURA / LEVER HANDLE

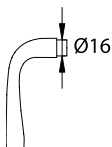

B25 CM Coppia impugnatura q.8 con grano con imposta ø16
Pair Lever Handle q.8 with grub screw-neck size ø16

A RICHIESTA / ON REQUEST:

- Mezza maniglia con placca o con rosetta (specificare se destra o sinistra) / Half lever handle on plate or on rose (to specify if right or left)
- Maniglia con rosette senza bocchette / Lever handle on rose without rose for key

art. 97 UOVO

materiale: Alluminio
material: Aluminium



97CM-AA



97CM-AB



97MR008-AB

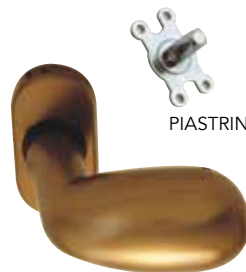

PIASTRINA P5

97PF009-AB



97MR009-AB

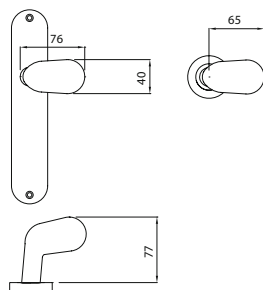

VERSIONI / VERSIONS



MANIGLIA CON ROSETTA / LEVER HANDLE ON ROSE



97 MR 008 Maniglia con rosetta 008 mm Ø50x8 con grano
Lever Handle on rose with grub screw



97 MR 009 Maniglia con rosetta 009 mm 62x32 ovale con grano
Lever Handle on rose oval with grub screw

POMOLO SU ROSETTA FISSAGGIO A PIASTRINA / KNOB ON ROSE WITH FIXING BASE



97 PF 009 Pomolo fisso con rosetta 009 mm 62x32 ovale c/piastrina
Fixed Knob on rose oval with fixing base

IMPUGNATURA / LEVER HANDLE

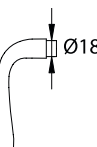

97 CM Coppia impugnatura q.8 con grano con imposta ø18
Pair Lever Handle q.8 with grub screw-neck size ø18

97 IP Solo impugnatura c/foro grano M6 in testa e foro q.8 con imposta ø18
Lever Handle only q.8 w.grub screw M6-front position-neck size ø18

	AB BRONZO F4	AA ARGENTO F1	
97 MR 008	•	•	5
97 MR 009	•	•	5
97 PF 009	•	•	4
97 CM	•	•	6
97 IP	•	•	

A RICHIESTA / ON REQUEST:

- Mezza maniglia con placca o con rosetta (specificare se destra o sinistra) / Half lever handle on plate or on rose (to specify if right or left)
- Maniglia con rosette senza bocchette / Lever handle on rose without rose for key

art. 62 ALASKA

materiale: Alluminio
material: Aluminium

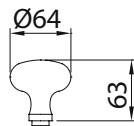

E62PR008-AB



E62PFP08-AB



E62PR008-AA



E62PFP08-AA

VERSIONI / VERSIONS



Finiture
Finishes

AB
BRONZO
F4

AA
ARGENTO
F1



COPPIA POMOLO CON ROSETTA / PAIR KNOBS ON ROSE

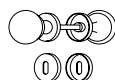

E62 PR 008 Coppia Pomolo Ø 62 con rosetta 008 Ø50x8 con grano
Pair Knob Ø 62 on rose with grub screw

•

•

2

POMOLI FISSI SU ROSETTA / KNOBS FIX ON ROSE



E62 PF P08 Pomolo fisso Ø 62 con rosetta P08 Ø50x8 con piastrina
Pair Knob Ø 62 on rose with fixing base

•

•

4

art. 317MD ALTERO

materiale: Alluminio
material: Aluminium



Fissaggio/Fitting

TIPO **F**

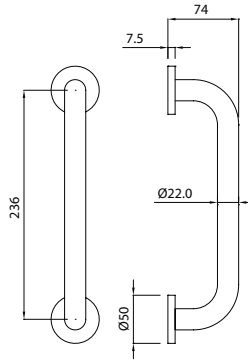
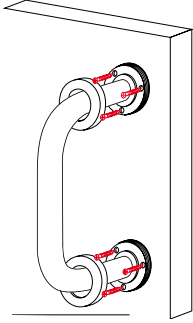

317MDP08-AB



VERSIONI / VERSIONS

MANIGLIONE DIRITTO SINGOLO / SINGLE STRAIGHT PULL HANDLE

317 MD P08 Maniglione singolo con rosetta P08 Ø50x8
Single Pull Handle on rose



Finiture
Finishes



AB
BRONZO
F4



F

27,07

2

art. 329MS ALPINO

materiale: Alluminio
material: Aluminium



Fissaggio/Fitting

TIPO **F**

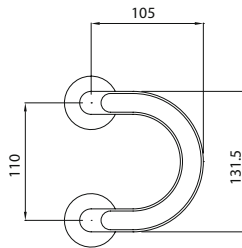
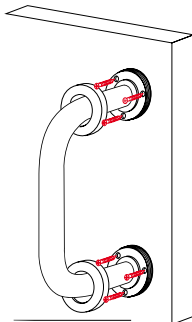

329MSP08-AA

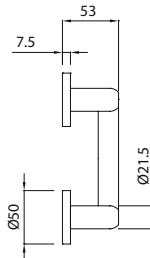
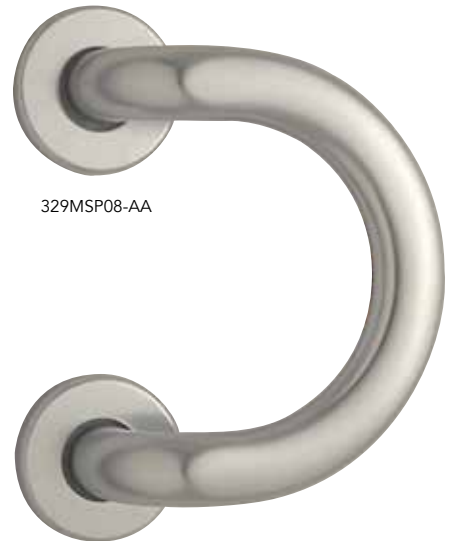

VERSIONI / VERSIONS

MANIGLIONE SPOSTATO SINGOLO / SINGLE OFF CENTRE PULL HANDLE

329 MS P08 Maniglione singolo con rosetta P08 Ø50x8
Single Pull Handle on rose



Finiture
Finishes



AB
BRONZO
F4

AA
ARGENTO
F1



F

•

•

2

materiale: Alluminio
material: Aluminium



498NOF08-AA

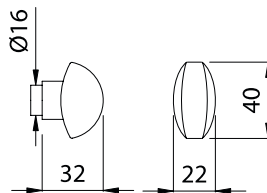

498NOF08-AB



498SP009-AB



498SP009-AA



498NOF22-AA

VERSIONI / VERSIONS



Finiture
Finishes

AB
BRONZO
F4

AA
ARGENTO
F1



SEGRETINO PICCOLO / SMALL WINDOW HANDLE						
24 SP 007	Segretino piccolo con rosetta Small window handle on rose	007	mm 68x28 q. 7 mm 68x28 square spindle q. 7	•	•	12
498 SP 009	Segretino piccolo con rosetta Small window handle on rose	009	mm 62x32 q. 6, 7 o 8 mm 62x32 square spindle q. 6, 7 o 8	•	•	12
COPPIA SEGRETINO PICCOLO / PAIR SMALL WINDOW HANDLE						
S97 CM	Coppia Segretino piccolo Pair Small window handle	q.6 q.6		•	•	12
NOTTOLINO LIBERO/OCCUPATO PER W.C. / WC TURN AND RELEASE						
498 NO F08	Nottolino libero/occupato per wc con rosetta WC turn and release on rose	F08	Ø 50 con finestra Ø 50 with indicator	•	•	6
498 NO F22	Nottolino libero/occupato per wc su placca WC turn and release on rose on plate	022	mm 228x42 con finestra mm 228x42 with indicator	•	•	6
MANETTINA / SMALL HANDLE						
381 MT	Manettina mm 90x23 Small Handle mm 90x23			•	•	24



24SP007-AA

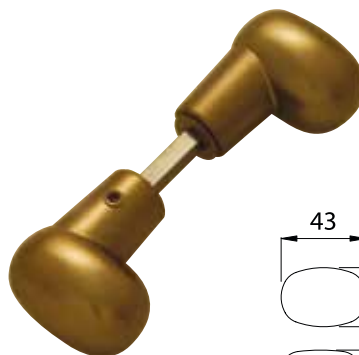
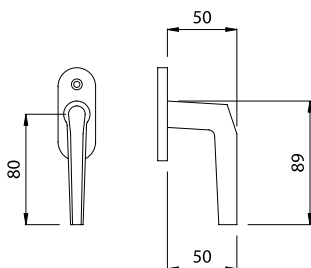

S97CM-AB

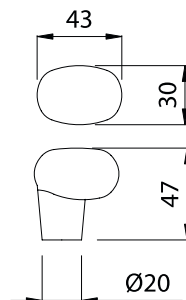

381MT-AA

381MT-AB

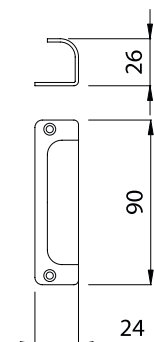



Detrazioni per coppie pomolo e coppie maniglia senza bocchette
Amount to deduct

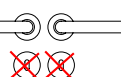

Per 008

AB -1,68 €
AA -1,68 €
AO -1,81 €

Per 009

AB -1,88 €
AA -1,88 €
AO -2,01 €

VERSIONI / VERSIONS



Finiture
Finishes

AB
BRONZO
F4

AA
ARGENTO
F1

ROSETTE / ROSE

	003 RO	Rosetta coprivite Ø45 con foro tondo Ø18 Cover screw rose Ø45, with round hole Ø18	•	•
	008 RO	Rosetta coprivite Ø50 con foro tondo Ø18 Cover rose Ø50 with round hole Ø18	•	•
	009 RO	Rosetta coprivite ovale mm 62x32 con foro tondo Ø18 Oval cover screws rose mm 62x32 with round hole Ø18	•	•

BOCCHETTE / ROSE FOR KEY

	003 BY	Bocchetta coprivite Ø45 foro yale Cover screw rose for key Ø45 for euro profile cylinder hole (yale)	•	•
	003 BN	Bocchetta coprivite Ø45 Cover screw rose for key Ø45	•	•
	008 BY	Bocchetta coprivite Ø50 foro yale Cover screw rose for key Ø50 for euro profile cylinder hole (yale)	•	•
	008 BN	Bocchetta coprivite Ø50 Cover screw rose for key Ø50	•	•
	009 BY	Bocchetta ovale mm 62x32 con foro yale Oval cover screws rose for key mm 62x32 for euro profile cylinder hole (yale)	•	•
	009 BN	Bocchetta ovale mm 62x32 Oval cover screws rose for key mm 62x32 suitable to insert returning spring mm 62x32	•	•

BOCCHETTA COPRIVITE CIECA / BLIND COVER SCREW ROSE

	008 BC	Bocchetta coprivite Ø50 cieca Blind Cover screw rose Ø50	•	•
--	--------	---	---	---

PLACCHE

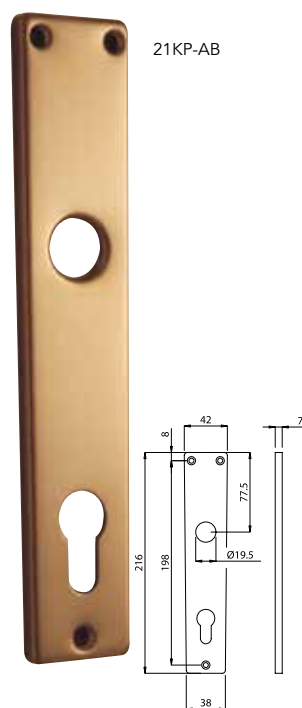
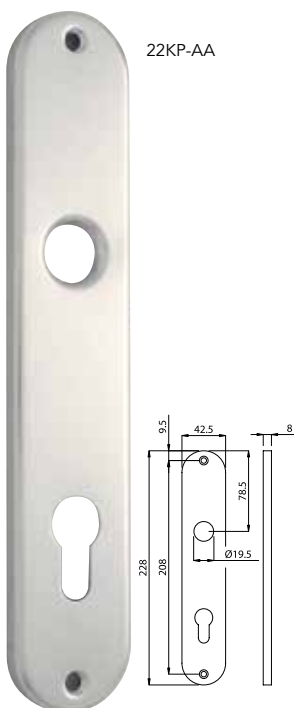
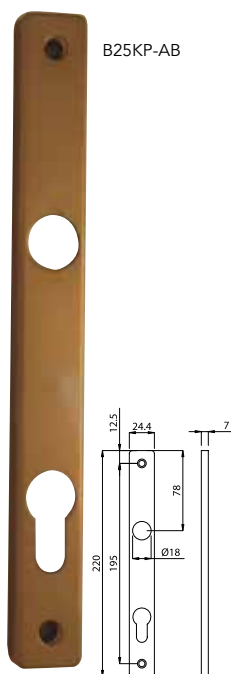

VERSIONI / VERSIONS



Finiture
Finishes

PLACCA PER MANIGLIA / PLATE FOR LEVER HANDLE

					AB BRONZO F4	AA ARGENTO F1	AO ORO F3
	21 KP	Placca per maniglia Plate for Lever Handle	mm 216x42x38	con foro chiave normale o yale	•	•	•
	22 KP	Placca per maniglia Plate for Lever Handle	mm 228x42	con foro chiave normale o yale	•	•	•
	B25 KP	Placca per maniglia Plate for Lever Handle	mm 220x25	con foro chiave normale o yale	•	•	•

PORTE D'ENTRATA
ENTRANCE DOORS



SISTEMA DI COLLEGAMENTO MANIGLIONE FISSO ESTERNO E MANIGLIA GIREVOLE INTERNA

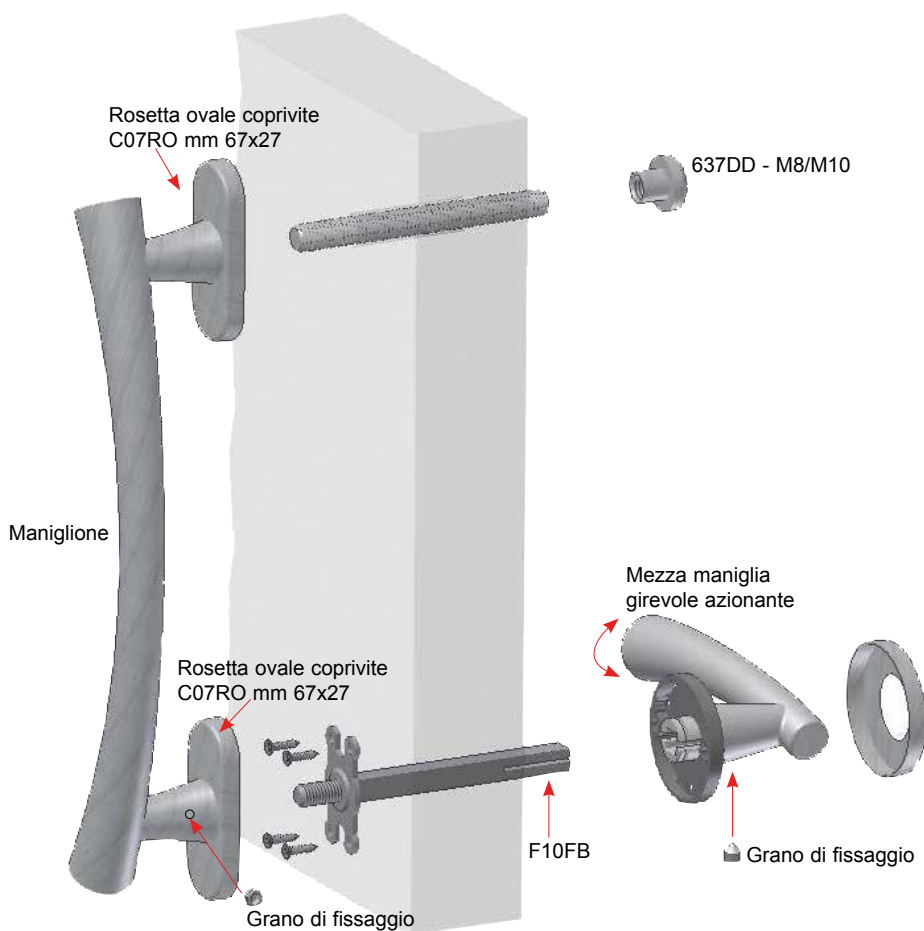

a richiesta: possibile avere maniglia interna con rosetta ovale, oppure maniglione con rosetta tonda $\varnothing 45$ utilizzando la piastrina F03



SISTEMA DI MONTAGGIO PER MANIGLIONE SINGOLO SU PORTA A VETRO

System for single pull handle on glass door

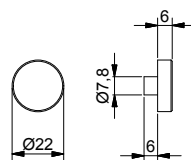

Su richiesta adatto a maniglioni :
On request suitable for pull handles:

130MD - 160MD - 185MS - 200 MD - 320MS - 330MS - 331MD - 423MD - 425MS - 433MD

ART.

CD G22

Set con 2 dadi G22 DD + 2 tronconi M6 + 4 guarnizioni in nylon
Set 2 Nut G22 DD + 2 screw M6 + 4 nylon washer



LV	OSC OC	PVD
•	•	•

MANIGLIONI SINGOLI E ACCOPPIATI PER INFISSI IN LEGNO, ALLUMINIO, PVC E VETRO
 SINGLE OR PAIR PULL HANDLES FOR WOOD, ALLUMINIUM, PVC OR GLASS DOORS

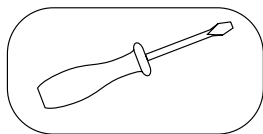

TIPI DI INSTALLAZIONE
 INSTALLATION

TIPO **F**

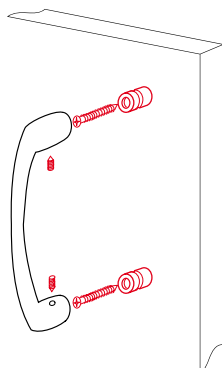
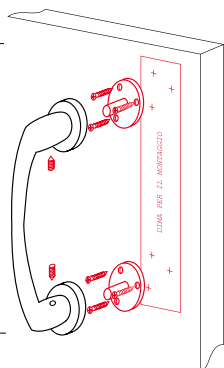
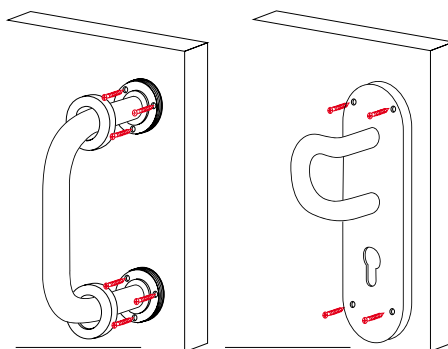

TIPO **P**

con vite autofilettante DIN 7982 adatta a porte in legno/alluminio/pvc
 with self-threading screw - DIN 7982,
 suitable for Wooden,
 Aluminium and Pvc doors

TIPO **T**

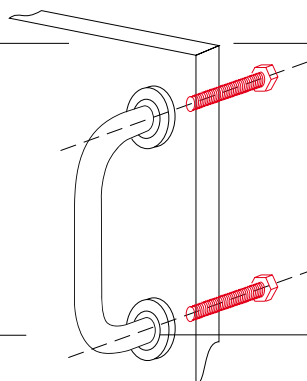

TIPO **FT**

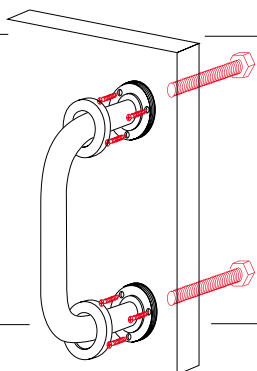

TIPO **AC**

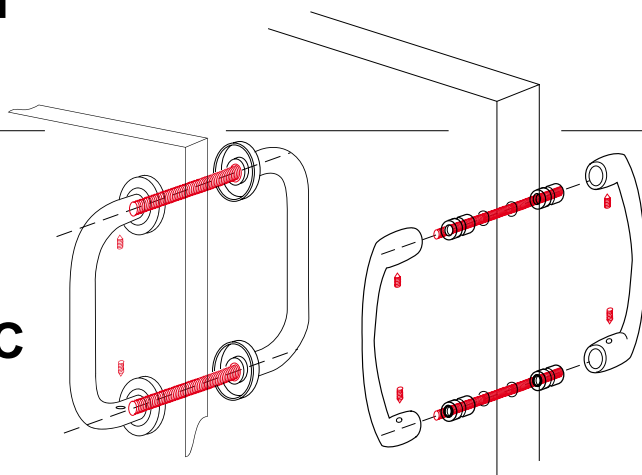

art. CD 265/275



CD 265	Set con due tronconi M8x80 - 2 rond.ferro - 2 dadi M8	• €
CD 275	Set con due tronconi M10x80 - 2 rond.ferro - 2 dadi M10	• €

art. CD 276/277



OTTONE CROMATO

OTTONE GREZZO

CD 276	Set con due tronconi M8x80 - 2 dadi ciechi M8	OTT. GREZZO	OTT. CROMATO
CD 277	Set con due tronconi M10x80 - 2 dadi ciechi M10	• €	• €

OTT. GREZZO	OTT. CROMATO
• €	• €
• €	• €

KIT PER MANIGLIONI ACCOPPIATI KIT FOR PAIR PULL HANDLES

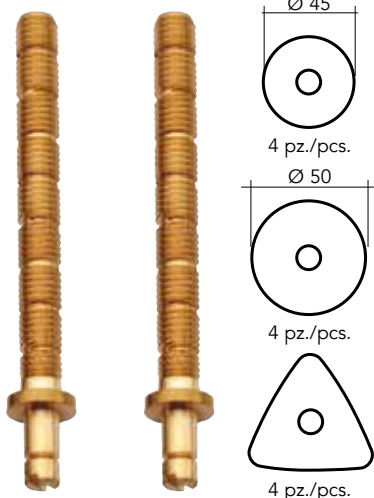

Consente di accoppiare maniglioni su porte in vetro, legno, PVC o alluminio con i seguenti modelli singoli: This set allows to mount back to back pull handles for glass, wooden, PVC or aluminium doors on following items:

110 MS 002	325 MS
110 MS C07	326 MS
111 MS 002	327 MS
111 MS C07	330 MS 002
112 MD 002	335 MS
112 MD C07	332 MS
184 MD 002	342 MS
184 MD P05	362 MS
185 MS 002	423 MD 002
186 MS	425 MS Q02
185 MS C07	433 MD 002
318 MS 002	423 MD Q50
318 MS C07	433 MD Q50
319 MS 002	
319 MS C07	

000 CD 325 Kit composto da 2 tronconi M10 + n. 12 guarnizioni in nylon per vetro di diverse forme (vedi figura) **€ 12,06**
Kit composed by 2 threaded screw M10 + n. 12 nylon washer of different shapes for glass (see picture)

art. 35 ARTEMIDE

materiale: Ottone
material: Solid Brass

Brass Class
100% Ottone

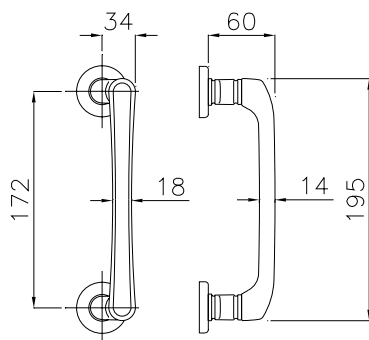

35 MS R46 LS



35 MS R46 BG



35 MS R46 LV



35 MS 037 LV



35 MS 035 BS

VERSIONI / VERSIONS



Finiture
Finishes

MANIGLIONE SPOSTATO SINGOLO / SINGLE OFF CENTRE PULL HANDLE

				Finiture Finishes		LV BG LS BS					
35 MS R46	Maniglione Singolo con rosetta Single Pull Handle on rose	R46	mm Ø46x8	tipo lusso	lusso type	FT	•				2
MANIGLIONE SPOSTATO SINGOLO CON PLACCA / SINGLE OFF CENTRE PULL HANDLE ON PLATE											
35 MS 035	Maniglione Singolo con placca Single Pull Handle on plate	035	mm 258x42			F	•				1
35 MS 037	Maniglione Singolo con placca Single Pull Handle on plate	037	mm 251x42			F	•				1

art. 37 MONIA

materiale: Ottone
material: Solid Brass

Brass Class
100% Ottone

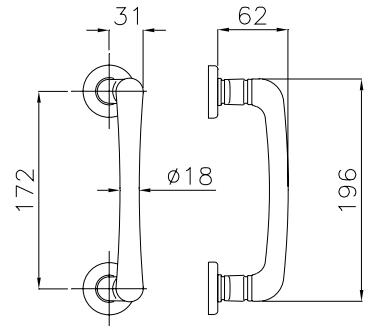

37 MS R46 LV



37 MS 037 LV



37 MS R46 OSC



37 MS R46 BG



37 MS R46 OS

VERSIONI / VERSIONS



Finiture
Finishes



LV BG
OS

OSC
OC

PVD



37 MS R46	Maniglione Singolo con rosetta Single Pull Handle on rose	R46	mm Ø46x8	tipo lusso luxso type	F	•	•	•	2
MANIGLIONE SPOSTATO SINGOLO CON PLACCA / SINGLE OFF CENTRE PULL HANDLE ON PLATE									
37 MS 037	Maniglione Singolo con placca Single Pull Handle on plate	037	mm 251x42		F	•	•	•	1

art.40MS GINEVRA

materiale: Ottone
material: Solid Brass

Brass Class
100% Ottone

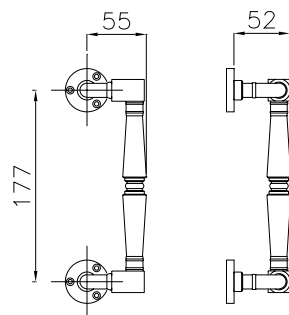

40 MS 202 AGV



40 MS 007 LV



40 MS R40 AN



40 MS 202 NC



40 MS M40 BG



40 MS 006 VBN



40 MS 006 BGO

VERSIONI / VERSIONS



Finiture
Finishes



MANIGLIONE SPOSTATO SINGOLO / SINGLE OFF CENTRE PULL HANDLE

40 MS 003	Maniglione Singolo con rosetta Single Pull Handle on rose	003	mm Ø45x7					
40 MS 006	Maniglione Singolo con rosetta Single Pull Handle on rose	006	mm Ø50x8	tipo lusso lusso type				
40 MS 007	Maniglione Singolo con rosetta Single Pull Handle on rose	007	mm 67x27	ovale stretta oval and reduced				
40 MS 202	Maniglione Singolo con rosetta Single Pull Handle on rose	202	mm Ø52x9	con bordo with edge				
40 MS R40	Maniglione Singolo con rosetta Single Pull Handle on rose	R40	mm Ø45x7	con fori viti with holes for screws				
40 MS R46	Maniglione Singolo con rosetta Single Pull Handle on rose	R46	mm Ø46x8	tipo lusso lusso type				
MANIGLIONE SPOSTATO SINGOLO CON PLACCA / SINGLE OFF CENTRE PULL HANDLE ON PLATE								
40 MS M40	Maniglione Singolo con placca Single Pull Handle on plate	M40	mm 242x37					

art. 40MD GINEVRA

materiale: Ottone
material: Solid Brass

Brass Class
100% Ottone

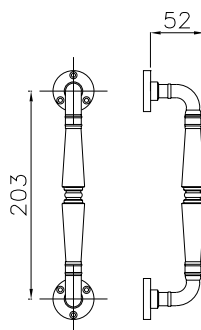

40 MD R40 AN



40 MD R46 LV



40 MD 202 AGV



40 MD 003 BG



40 MD 202 NC

VERSIONI / VERSIONS



Furniture
Finishes



LV
BG

NC

AN

AGV

PVD



MANIGLIONE DIRITTO SINGOLO / SINGLE STRAIGHT PULL HANDLE

40 MD 003	Maniglione Singolo con rosetta Single Pull Handle on rose	003 mm Ø45x7		FT	•		•	•		4
40 MD 006	Maniglione Singolo con rosetta Single Pull Handle on rose	006 mm Ø50x8	tipo lusso lusso type	F	•	•	•	•		2
40 MD 007	Maniglione Singolo con rosetta Single Pull Handle on rose	007 mm 67x27	ovale stretta oval and reduced	F	•		•	•		2
40 MD 202	Maniglione Singolo con rosetta Single Pull Handle on rose	202 mm Ø52x9	con bordo with edge	F	•	•	•	•		2
40 MD R40	Maniglione Singolo con rosetta Single Pull Handle on rose	R40 mm Ø45x7	con fori viti with holes for screws	F	•		•			2
40 MD R46	Maniglione Singolo con rosetta Single Pull Handle on rose	R46 mm Ø46x8	tipo lusso lusso type	F	•				•	2

MANIGLIONE DIRITTO ACCOPPIATO PER LEGNO / PAIR STRAIGHT PULL HANDLE FOR WOOD DOORS

40 LD 006	Maniglione Accoppiato per legno con rosetta Pair Pull Handle for wood doors on rose	006 mm Ø50x8	tipo lusso lusso type	AC	•	•	•	•		1
40 LD 202	Maniglione Accoppiato per legno con rosetta Pair Pull Handle for wood doors on rose	202 mm Ø52x9	con bordo with edge	AC	•	•	•	•		1

art. 81 SUSY

materiale: Ottone
material: Solid Brass

Brass Class
100% Ottone



81 MD R46 LV

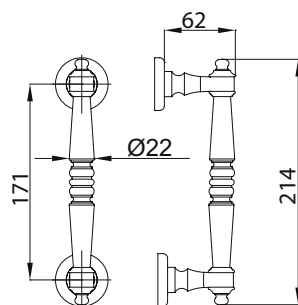

81 MD 003 BG

VERSIONI / VERSIONS



Finish
Finishes



LV
BG



MANIGLIONE DIRITTO SINGOLO / SINGLE STRAIGHT PULL HANDLE

81 MD 003 Maniglione Singolo con rosetta / Single Pull Handle on rose 003 mm Ø45x7

FT

•

2

81 MD R46 Maniglione Singolo con rosetta / Single Pull Handle on rose R46 mm Ø46x8 tipo lusso / lusso type

F

•

2

MANIGLIONE DIRITTO ACCOPPIATO PER LEGNO / PAIR STRAIGHT PULL HANDLE FOR WOOD DOORS

81 LD 003 Maniglione Accoppiato per legno con rosetta / Pair Pull Handle for wood doors on rose 003 mm Ø45x7

AC

•

1

81 LD R46 Maniglione Accoppiato per legno con rosetta / Pair Pull Handle for wood doors on rose R46 mm Ø46x8 tipo lusso / lusso type

AC

•

1

art. 184 ASTRA

materiale: Ottone
material: Solid Brass

Brass Class
100% Ottone



184 MD 005 OSC/OC

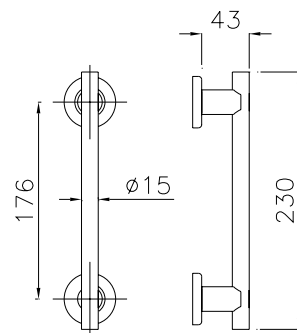

184 MD 005 LV

184 MD 005 OC

VERSIONI / VERSIONS



Finiture
Finishes



LV

OC
OC/LV

OSC
OSC/OC



MANIGLIONE DIRITTO SINGOLO / SINGLE STRAIGHT PULL HANDLE

184 MD 002	Maniglione Singolo con rosetta Single Pull Handle on rose	002	mm Ø45x10	con piastrina with fixing base	P	•	•	•	1
184 MD P05	Maniglione Singolo con rosetta Single Pull Handle on rose	P05	mm Ø50x8	con piastrina with fixing base	P	•	•	•	1
184 MD 005	Maniglione Singolo con rosetta Single Pull Handle on rose	005	mm Ø50x8	tipo lusso lusso type	F	•	•	•	1

MANIGLIONE DIRITTO ACCOPPIATO PER LEGNO / PAIR STRAIGHT PULL HANDLE FOR WOOD DOORS

184 LD 002	Maniglione Accoppiato per legno con rosetta Pair Pull Handle for wood doors on rose	002	mm Ø45x10		AC	•	•	•	1
184 LD 005	Maniglione Accoppiato per legno con rosetta Pair Pull Handle for wood doors on rose	005	mm Ø50x8	tipo lusso lusso type	AC	•	•	•	1

MANIGLIONE DIRITTO ACCOPPIATO PER VETRO / PAIR STRAIGHT PULL HANDLE FOR GLASS DOORS

184 MV 002	Maniglione Accoppiato per vetro con rosetta Pair Pull Handle for glass doors on rose	002	mm Ø45x10		AC	•	•	•	1
184 MV 005	Maniglione Accoppiato per vetro con rosetta Pair Pull Handle for glass doors on rose	005	mm Ø50x8	tipo lusso lusso type	AC	•	•	•	1

art. 111 COSMO

materiale: Ottone
material: Solid Brass

Brass Class
100% Ottone



111 MS R46 OC

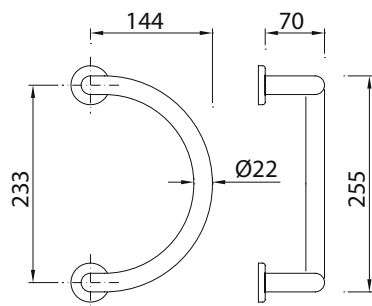

111 MS R46 LV



111 MS R46 OSC



111 MS R46 BG

VERSIONI / VERSIONS



Finiture
Finishes



LV
BG

OC
OSC

PVD



MANIGLIONE SPOSTATO SINGOLO / SINGLE OFF CENTRE PULL HANDLE

111 MS 002	Maniglione Singolo con rosetta Single Pull Handle on rose	002	mm Ø45x10	con piastrina with fixing base	P	•	•	•	1
111 MS 007	Maniglione Singolo con rosetta Single Pull Handle on rose	007	mm 67x27	ovale stretta oval and reduced	FT	•	•	•	1
111 MS R46	Maniglione Singolo con rosetta Single Pull Handle on rose	R46	mm Ø46x8	tipo lusso luxu type	FT	•	•	•	1
111 MS C07	Maniglione Singolo con rosetta Single Pull Handle on rose	C07	mm 67x27	con piastrina with fixing base	P	•	•	•	1

MANIGLIONE SPOSTATO ACCOPPIATO PER LEGNO / PAIR OFF CENTRE PULL HANDLE FOR WOOD DOORS

111 LS 002	Maniglione Accoppiato per legno con rosetta Pair Pull Handle for wood doors on rose	002	mm Ø45x10		AC	•	•	•	1
111 LS 007	Maniglione Accoppiato per legno con rosetta Pair Pull Handle for wood doors on rose	007	mm 67x27	ovale stretta oval and reduced	AC	•	•	•	1
111 LS R46	Maniglione Accoppiato per legno con rosetta Pair Pull Handle for wood doors on rose	R46	mm Ø46x8	tipo lusso luxu type	AC	•	•	•	1
111 LS C07	Maniglione Accoppiato per legno con rosetta Pair Pull Handle for wood doors on rose	C07	mm 67x27	ovale stretta oval and reduced	AC	•	•	•	1

MANIGLIONE SPOSTATO ACCOPPIATO PER VETRO / PAIR OFF CENTRE PULL HANDLE FOR GLASS DOORS

111 MV 002	Maniglione Accoppiato per vetro con rosetta Pair Pull Handle for glass doors on rose	002	mm Ø45x10		AC	•	•	•	1
111 MV R46	Maniglione Accoppiato per vetro con rosetta Pair Pull Handle for glass doors on rose	R46	mm Ø46x8	tipo lusso luxu type	AC	•	•	•	1

112 COSMO

materiale: Ottone
material: Solid Brass

Brass Class
100% Ottone



112 MD R46 OSC



112 MD R46 LV



112 MD R46 OC



112 MD R46 BG

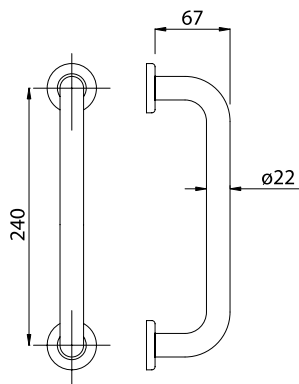

VERSIONI / VERSIONS



Finiture
Finishes



LV
BG

OC
OSC

PVD



MANIGLIONE DIRITTO SINGOLO / SINGLE STRAIGHT PULL HANDLE

112 MD 002	Maniglione Singolo con rosetta Single Pull Handle on rose	002	mm Ø45x10	con piastrina with fixing base	P	•	•	•	1
112 MD 007	Maniglione Singolo con rosetta Single Pull Handle on rose	007	mm 67x27	ovale stretta oval and reduced	FT	•	•		1
112 MD R46	Maniglione Singolo con rosetta Single Pull Handle on rose	R46	mm Ø46x8	tipo lusso lusso type	FT	•	•	•	1
112 MD C07	Maniglione Singolo con rosetta Single Pull Handle on rose	C07	mm 67x27	con piastrina with fixing base	P	•	•	•	1

MANIGLIONE DIRITTO ACCOPPIATO PER LEGNO / PAIR STRAIGHT PULL HANDLE FOR WOOD DOORS

112 LD 002	Maniglione Accoppiato per legno con rosetta Pair Pull Handle for wood doors on rose	002	mm Ø45x10		AC	•	•	•	1
112 LD 007	Maniglione Accoppiato per legno con rosetta Pair Pull Handle for wood doors on rose	007	mm 67x27	ovale stretta oval and reduced	AC	•	•		1
112 LD R46	Maniglione Accoppiato per legno con rosetta Pair Pull Handle for wood doors on rose	R46	mm Ø46x8	tipo lusso lusso type	AC	•	•	•	1
112 LD C07	Maniglione Accoppiato per legno con rosetta Pair Pull Handle for wood doors on rose	C07	mm 67x27	ovale stretta oval and reduced	AC	•	•	•	1

MANIGLIONE DIRITTO ACCOPPIATO PER VETRO / PAIR STRAIGHT PULL HANDLE FOR GLASS DOORS

112 MV 002	Maniglione Accoppiato per vetro con rosetta Pair Pull Handle for glass doors on rose	002	mm Ø45x10		AC	•	•	•	1
112 MV R46	Maniglione Accoppiato per vetro con rosetta Pair Pull Handle for glass doors on rose	R46	mm Ø46x8	tipo lusso lusso type	AC	•	•	•	1

art. 160MD LINEO

materiale: Zama
material: Zamak

TeKnoMetal
Linea in zama

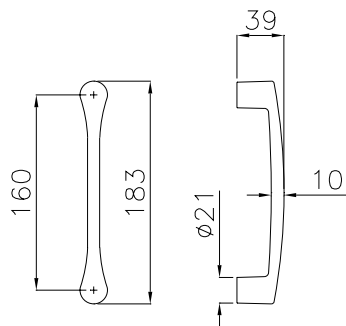

160 MD - OTT. BRILL.



160 MD - ZSC



160 MD - BGO



esempio di accoppiati con installazione
example of back to back assembling

VERSIONI / VERSIONS



Finiture
Finishes

MANIGLIONE DIRITTO SINGOLO / SINGLE STRAIGHT PULL HANDLE

		OTT. BRILL. ZBG	ZSC ZCR	BGO	
160 MD	Maniglione Singolo. Inclusi accessori per montaggio singolo (tipo P) e accoppiato per legno e vetro (tipo AC).	P - AC	•	•	2
Single Pull Handle, including accessories for single (type P) and back to back (type AC) pull handle, on wooden and glass doors					

TIPO **P**

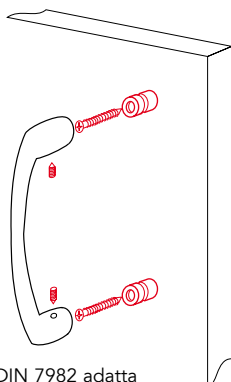

TIPO **AC**

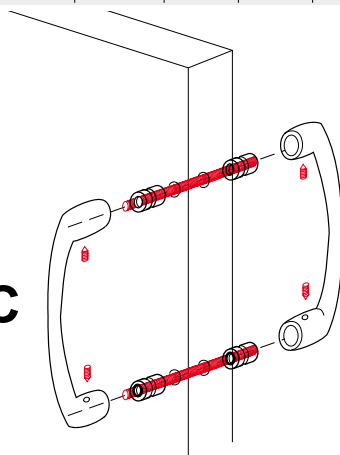

con vite autofilettante DIN 7982 adatta a porte in legno/alluminio/pvc
with self-threading screw - DIN 7982, suitable for Wooden, Aluminium and Pvc doors

art. 200MD LINEO

materiale: Zama
material: Zamak

TeKnoMetal
Linea in zama



200 MD - OTT. BRILL.



200 MD - ZBG



200 MD - BGO

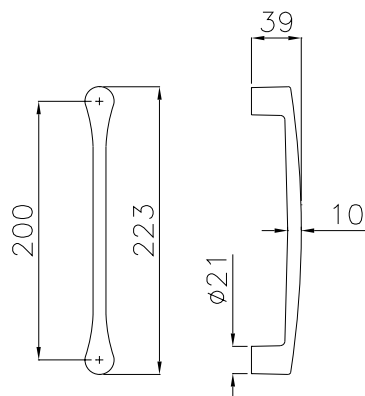

esempio di accoppiati con installazione
example of back to back assembling

VERSIONI / VERSIONS



Finiture
Finishes

MANIGLIONE DIRITTO SINGOLO / SINGLE STRAIGHT PULL HANDLE

		OTT. BRILL. ZBG	ZSC ZCR	BGO	
200 MD	Maniglione Singolo. Inclusi accessori per montaggio singolo (tipo P) e accoppiato per legno e vetro (tipo AC).	•	•	•	2
	Single Pull Handle, including accessories for single (type P) and back to back (type AC) pull handle, on wooden and glass doors				

TIPO **P**

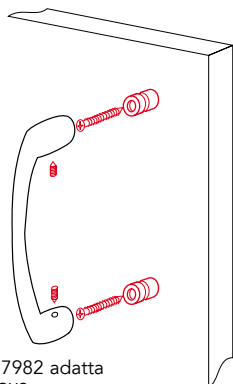

con vite autofilettante DIN 7982 adatta a porte in legno/alluminio/pvc
with self-threading screw - DIN 7982, suitable for Wooden, Aluminium and Pvc doors

TIPO **AC**

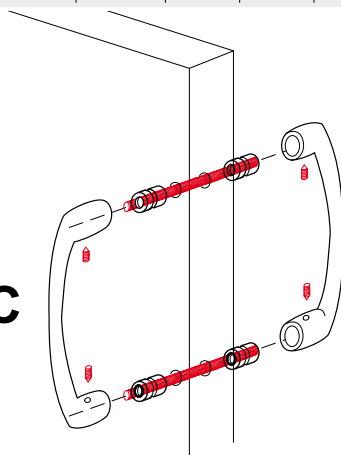

art. 185 ALMA

design: Marco Pialorsi
 materiale: Ottone
 material: Solid Brass

Brass Class
 100% Ottone



185 MS - LV

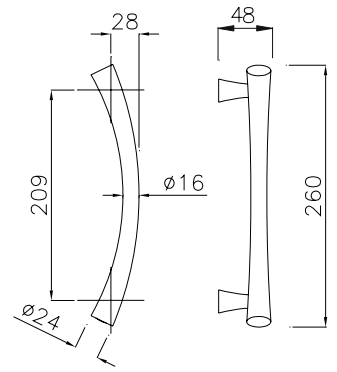

185 MS - OSC



185 MS - OC



185 MS - PVD INOX



185 MS - BG

VERSIONI / VERSIONS



Finiture
 Finishes



MANIGLIONE SPOSTATO SINGOLO / SINGLE OFF CENTRE PULL HANDLE

	LV	BG	OC OSC	PVD	PVD INOX	
185 MS Maniglione Singolo. Inclusi accessori per montaggio singolo (tipo P) e accoppiato per legno e vetro (tipo AC).	P-AC	•	•	•	•	1
Single Pull Handle, including accessories for single (type P) and back to back (type AC) pull handle, on wooden and glass doors						

TIPO **P**

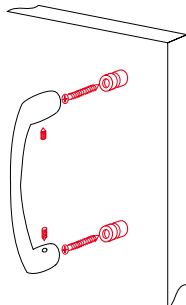

TIPO **AC**

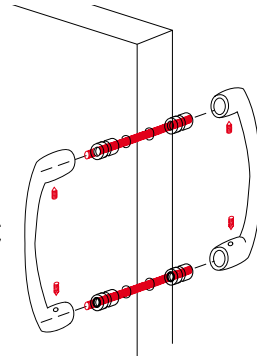

con vite autofilettante DIN 7982 adatta a porte in legno/alluminio/pvc
 with self-threading screw - DIN 7982, suitable for Wooden, Aluminium and Pvc doors

art. 185 ALMA

design: Marco Pialorsi
materiale: Ottone
material: Solid Brass

Brass Class
100% Ottone



185 MS R46 LV

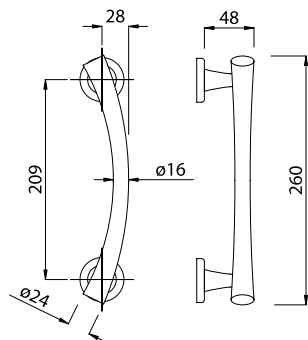

185 MS 002 PVD

185 MS R46 OSC



185 MS C07 LV



185 MS R46 BG



185 MS R46 OC



VERSIONI / VERSIONS



Finiture
Finishes



LV BG

OC
OC/LV

OSC
OSC/OC

PVD

PVD
INOX



MANIGLIONE SPOSTATO SINGOLO / SINGLE OFF CENTRE PULL HANDLE

185 MS 002	Maniglione Singolo con rosetta Single Pull Handle on rose	002	mm Ø45x10	con piastrina with fixing base	P	•	•	•	•	•	1
185 MS 003	Maniglione Singolo con rosetta Single Pull Handle on rose	003	mm Ø45x7		FT	•	•2	•2			1
185 MS 007	Maniglione Singolo con rosetta Single Pull Handle on rose	007	mm 67x27	ovale stretta oval and reduced	F	•	•	•			1
185 MS R46	Maniglione Singolo con rosetta Single Pull Handle on rose	R46	mm Ø46x8	tipo lusso lusso type	F	•	•	•	•		1
185 MS C07	Maniglione Singolo con rosetta Single Pull Handle on rose	C07	mm 67x27	con piastrina with fixing base	P	•	•	•	•		1

MANIGLIONE SPOSTATO ACCOPPIATO PER LEGNO / PAIR OFF CENTRE PULL HANDLE FOR WOOD DOORS

185 LS 002	Maniglione Accoppiato per legno c/rosetta Pair Pull Handle for wood doors on rose	002	mm Ø45x10		AC	•	•	•	•	•	1
185 LS 003	Maniglione Accoppiato per legno c/rosetta Pair Pull Handle for wood doors on rose	003	mm Ø45x7		AC	•	•	•			1
185 LS 007	Maniglione Accoppiato per legno c/rosetta Pair Pull Handle for wood doors on rose	007	mm 67x27	ovale stretta oval and reduced	AC	•	•	•			1
185 LS R46	Maniglione Accoppiato per legno c/rosetta Pair Pull Handle for wood doors on rose	R46	mm Ø46x8	tipo lusso lusso type	AC	•	•	•	•		1
185 LS C07	Maniglione Accoppiato per legno c/rosetta Pair Pull Handle for wood doors on rose	C07	mm 67x27	ovale stretta oval and reduced	AC	•	•	•	•		1

MANIGLIONE SPOSTATO ACCOPPIATO PER VETRO / PAIR OFF CENTRE PULL HANDLE FOR GLASS DOORS

185 MV 002	Maniglione Accoppiato per vetro c/rosetta Pair Pull Handle for glass doors on rose	002	mm Ø45x10		AC	•	•	•	•	•	1
185 MV R46	Maniglione Accoppiato per vetro c/rosetta Pair Pull Handle for glass doors on rose	R46	mm Ø46x8	tipo lusso lusso type	AC	•	•	•	•		1

art. 186 ARCHI

design: Marco Pialorsi
 materiale: Ottone
 material: Solid Brass

Brass Class
 100% Ottone



186 MS - LV

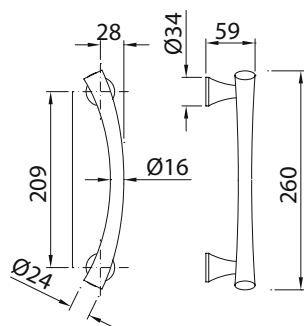

186 MS - OSC



186 MS - OC



186 MS - PVD INOX

VERSIONI / VERSIONS



Finiture
 Finishes



MANIGLIONE SPOSTATO SINGOLO / SINGLE OFF CENTRE PULL HANDLE

186 MS	Maniglione Singolo. Single Pull Handle.	P	LV	OC OSC	PVD	PVD INOX	1
			•	•	•	•	1

MANIGLIONE SPOSTATO ACCOPPIATO PER LEGNO / PAIR OFF CENTRE PULL HANDLE FOR WOOD DOORS

186 LS	Maniglione Accoppiato per legno Pair Pull Handle for wood doors	AC	•	•	•	•	1
--------	--	----	---	---	---	---	---

MANIGLIONE SPOSTATO ACCOPPIATO PER VETRO / PAIR OFF CENTRE PULL HANDLE FOR GLASS DOORS

186 MV	Maniglione Accoppiato per vetro Pair Pull Handle for glass doors	AC	•	•	•	•	1
--------	---	----	---	---	---	---	---

TIPO P

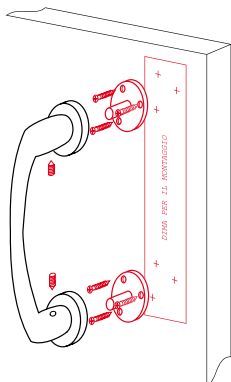

art. 312 ELENA

materiale: Ottone
material: Solid Brass

Brass Class
100% Ottone

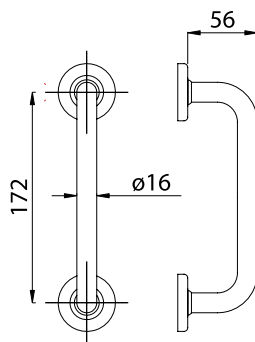

312 MD R46 BG



312 MD R46 LV



312 MD R46 OC



312 MD 003 OSC



312 MD 037 LV

VERSIONI / VERSIONS



Finiture
Finishes

VERSIONI / VERSIONS					LV BG	OC OSC	
MANIGLIONE DIRITTO SINGOLO / SINGLE STRAIGHT PULL HANDLE							
312 MD 003	Maniglione Singolo con rosetta Single Pull Handle on rose	003	mm Ø45x7	FT	•	•	2
312 MD 007	Maniglione Singolo con rosetta Single Pull Handle on rose	007	mm 67x27	F	•	•	2
312 MD R46	Maniglione Singolo con rosetta Single Pull Handle on rose	R46	mm Ø46x8	F	•	•	2
312 MD C07	Maniglione Singolo con rosetta Single Pull Handle on rose	C07	mm 67x27	P	•	•	2
MANIGLIONE DIRITTO ACCOPPIATO PER LEGNO / PAIR STRAIGHT PULL HANDLE FOR WOOD DOORS							
312 LD 003	Maniglione Accoppiato per legno con rosetta Pair Pull Handle for wood doors on rose	003	mm Ø45x7	AC	•	•	1
312 LD R46	Maniglione Accoppiato per legno con rosetta Pair Pull Handle for wood doors on rose	R46	mm Ø46x8	AC	•	•	1
MANIGLIONE DIRITTO SINGOLO CON PLACCA / SINGLE STRAIGHT PULL HANDLE ON PLATE							
312 MD 037	Maniglione Singolo con placca Single Pull Handle on plate	037	mm 251x42	F	•	•	1

art. 315 UNIVERSO

materiale: Ottone
material: Solid Brass

Brass Class
100% Ottone

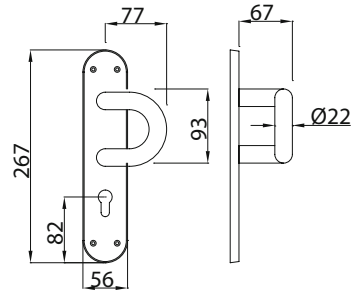

315 MS - OC



315 MS - LV



315 MS - BG



315 MS - OSC

VERSIONI / VERSIONS



Finiture
Finishes



LV BG
OS

OC
OSC

PVD



MANIGLIONE SPOSTATO SINGOLO / SINGLE OFF CENTRE PULL HANDLE

315 MS	Maniglione Singolo con placca yale Single Pull Handle on yale plate	mm 267x56	F	•	•	•	1

art. 316 UNIVERSO

materiale: Ottone
material: Solid Brass

Brass Class
100% Ottone

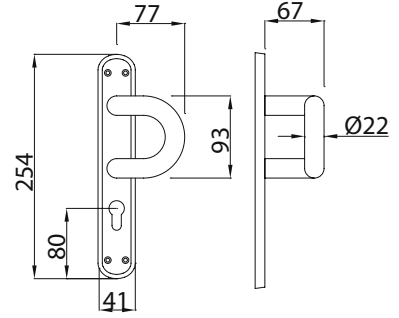

316 MS - BG



316 MS - LV



316 MS - OC



316 MS - OSC

VERSIONI / VERSIONS



Finiture
Finishes



LV
BG

OC
OSC

PVD



MANIGLIONE SPOSTATO SINGOLO / SINGLE OFF CENTRE PULL HANDLE

316 MS	Maniglione Singolo con placca yale Single Pull Handle on yale plate	mm 254x41	F	•	•	•	1

art. 318 COSMO

materiale: Ottone
material: Solid Brass

Brass Class
100% Ottone

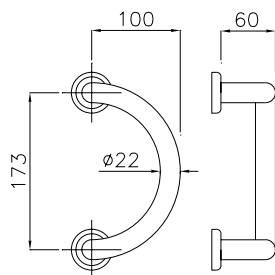

318 MS R46 OSC



318 MS R46 PVD

318 MS C07 LV

318 MS R46 BG

318 MS R46 OC

VERSIONI / VERSIONS



Finishes
Finitures



LV
BG

OC
OSC

PVD



MANIGLIONE SPOSTATO SINGOLO / SINGLE OFF CENTRE PULL HANDLE

318 MS 002	Maniglione Singolo con rosetta Single Pull Handle on rose	002	mm Ø45x10	con piastrina with fixing base	P	•	•	•	1
318 MS 007	Maniglione Singolo con rosetta Single Pull Handle on rose	007	mm 67x27	ovale stretta oval and reduced	FT	•	•	•	1
318 MS R46	Maniglione Singolo con rosetta Single Pull Handle on rose	R46	mm Ø46x8	tipo lusso lusso type	FT	•	•	•	1
318 MS C07	Maniglione Singolo con rosetta Single Pull Handle on rose	C07	mm 67x27	con piastrina with fixing base	P	•	•	•	1

MANIGLIONE SPOSTATO ACCOPPIATO PER LEGNO / PAIR OFF CENTRE PULL HANDLE FOR WOOD DOORS

318 LS 002	Maniglione Accoppiato per legno con rosetta Pair Pull Handle for wood doors on rose	002	mm Ø45x10		AC	•	•	•	1
318 LS 007	Maniglione Accoppiato per legno con rosetta Pair Pull Handle for wood doors on rose	007	mm 67x27	ovale stretta oval and reduced	AC	•	•	•	1
318 LS R46	Maniglione Accoppiato per legno con rosetta Pair Pull Handle for wood doors on rose	R46	mm Ø46x8	tipo lusso lusso type	AC	•	•	2•	1
318 LS C07	Maniglione Accoppiato per legno con rosetta Pair Pull Handle for wood doors on rose	C07	mm 67x27	ovale stretta oval and reduced	AC	•	•	•	1

MANIGLIONE SPOSTATO ACCOPPIATO PER VETRO / PAIR OFF CENTRE PULL HANDLE FOR GLASS DOORS

318 MV 002	Maniglione Accoppiato per vetro con rosetta Pair Pull Handle for glass doors on rose	002	mm Ø45x10		AC	•	•	•	1
318 MV R46	Maniglione Accoppiato per vetro con rosetta Pair Pull Handle for glass doors on rose	R46	mm Ø46x8	tipo lusso lusso type	AC	•	•	2•	1

art. 319 DUNA

materiale: Ottone
material: Solid Brass

Brass Class
100% Ottone

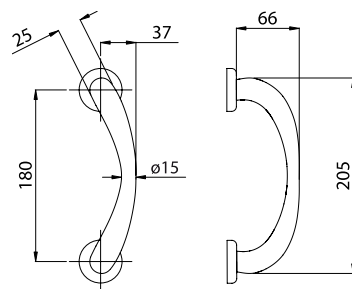

319 MS 006 LV



319 MS 006 BG



319 MS 006 OC



319 MS 006 OSC

VERSIONI / VERSIONS



Finiture
Finishes



LV
BG

OC
OSC

PVD



MANIGLIONE SPOSTATO SINGOLO / SINGLE OFF CENTRE PULL HANDLE									
319 MS 002	Maniglione Singolo con rosetta Single Pull Handle on rose	002	mm Ø45x10	con piastrina with fixing base	P	•	•	•	1
319 MS 007	Maniglione Singolo con rosetta Single Pull Handle on rose	007	mm 67x27	ovale stretta oval and reduced	FT	•	•		1
319 MS 006	Maniglione Singolo con rosetta Single Pull Handle on rose	006	mm Ø50x8	tipo lusso lusso type	F	•	•	•	1
319 MS C07	Maniglione Singolo con rosetta Single Pull Handle on rose	C07	mm 67x27	con piastrina with fixing base	P	•	•	•	1
MANIGLIONE SPOSTATO ACCOPPIATO PER LEGNO / PAIR OFF CENTRE PULL HANDLE FOR WOOD DOORS									
319 LS 002	Maniglione Accoppiato per legno con rosetta Pair Pull Handle for wood doors on rose	002	mm Ø45x10		AC	•	•	•	1
319 LS 007	Maniglione Accoppiato per legno con rosetta Pair Pull Handle for wood doors on rose	007	mm 67x27	ovale stretta oval and reduced	AC	•	•		1
319 LS 006	Maniglione Accoppiato per legno con rosetta Pair Pull Handle for wood doors on rose	006	mm Ø50x8	tipo lusso lusso type	AC	•	•	2•	1
319 LS C07	Maniglione Accoppiato per legno con rosetta Pair Pull Handle for wood doors on rose	C07	mm 67x27	ovale stretta oval and reduced	AC	•	•	•	1
MANIGLIONE SPOSTATO ACCOPPIATO PER VETRO / PAIR OFF CENTRE PULL HANDLE FOR GLASS DOORS									
319 MV 002	Maniglione Accoppiato per vetro con rosetta Pair Pull Handle for glass doors on rose	002	mm Ø45x10		AC	•	•	•	1
319 MV 006	Maniglione Accoppiato per vetro con rosetta Pair Pull Handle for glass doors on rose	006	mm Ø50x8	tipo lusso lusso type	AC	•	•	2•	1

art. 325 ARTEMIO

design: Marco Pialorsi
 materiale: Ottone
 material: Solid Brass

Brass Class
 100% Ottone

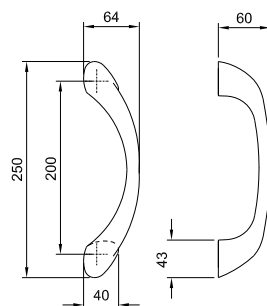

325 MS - PVD



325 MS - LV



325 MS - OC



325 MS - OSC



325 MS - BG

VERSIONI / VERSIONS



Finiture
 Finishes



LV
 BG

OC
 OSC

PVD

PVD
 INOX



MANIGLIONE SPOSTATO SINGOLO / SINGLE OFF CENTRE PULL HANDLE

325 MS	Maniglione Singolo Single Pull Handle	P	•	•	•	•	1
--------	--	---	---	---	---	---	---

MANIGLIONE SPOSTATO ACCOPPIATO PER LEGNO / PAIR OFF CENTRE PULL HANDLE FOR WOOD DOORS

325 LS	Maniglione Accoppiato per legno Pair Pull Handle for wood doors	AC	•	•	•	•	1
--------	--	----	---	---	---	---	---

MANIGLIONE SPOSTATO ACCOPPIATO PER VETRO / PAIR OFF CENTRE PULL HANDLE FOR GLASS DOORS

325 MV	Maniglione Accoppiato per vetro Pair Pull Handle for glass doors	AC	•	•	•	•	1
--------	---	----	---	---	---	---	---

000CD325

Kit 2 tronconi M10 per maniglioni accoppiati
 (vedi pag. 298)

Kit 2 threaded screws M10 for Pair Pull Handle
 (see pag. 298)

€ 12,06

art. 319 DUNA

materiale: Ottone
material: Solid Brass

Brass Class
100% Ottone



319 MS 319 - OSC



319 MS 319 - LV

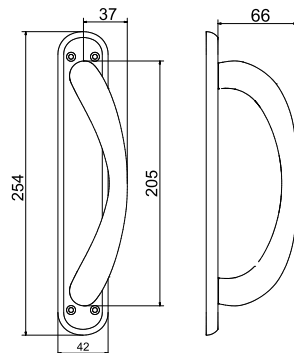

VERSIONI / VERSIONS



Finiture
Finishes



LV
BG

OSC
OC

PVD

PVD INOX



MANIGLIONE SPOSTATO SINGOLO / SINGLE OFF CENTRE PULL HANDLE

Maniglione singolo con placca
319 MS 319 Single pull handle on plate 319 mm 254x42

F

•

•

•

•

1

art. 326 ARTEMIO DUE

design: Marco Pialorsi
materiale: Ottone
material: Solid Brass

Brass Class
100% Ottone



326 MS - OSC/OC



326 MS - OS/LV

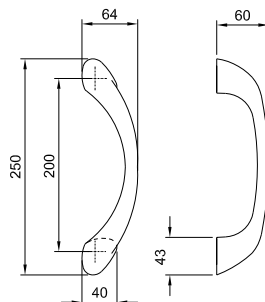

VERSIONI / VERSIONS



Finiture
Finishes



OS/LV

OSC/OC



MANIGLIONE SPOSTATO / OFF CENTRE PULL HANDLE

326 MS Maniglione singolo
Single pull handle

326 LS Maniglione accoppiato per legno
Pair pull handle for wood door

326 MV Maniglione accoppiato per vetro
Pair pull handle for glass door

P

•

•

1

AC

•

•

1

AC

•

•

1

art. 320 SUN 20

design: Marco Pialorsi
 materiale: Ottone
 material: Solid Brass

Brass Class
 100% Ottone



320 MS - OSC



320 MS - OC



320 MS - LV



320 MS - BG

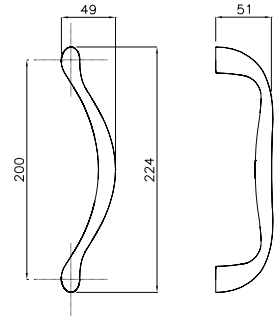

VERSIONI / VERSIONS



Finishes
 Finishes

MANIGLIONE SPOSTATO SINGOLO / SINGLE OFF CENTRE PULL HANDLE

320 MS Maniglione Singolo.
 Inclusi accessori per montaggio singolo (tipo P) e accoppiato per legno e vetro (tipo AC).

Single Pull Handle, including accessories for single (type P) and back to back (type AC) pull handle, on wooden and glass doors



LV
 BG

OSC
 OC

BGO

PVD



P - AC

•

•

•

•

2

TIPO **P**

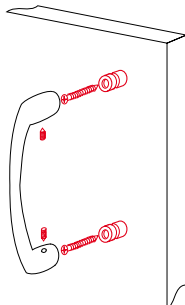

TIPO **AC**

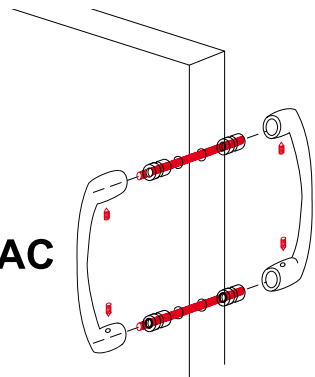

con vite autofilettante DIN 7982 adatta
 a porte in legno/alluminio/pvc
 with self-threading screw - DIN 7982,
 suitable for Wooden,
 Aluminium and Pvc doors

art. 320 SUN 20

design: Marco Pialorsi
 materiale: Ottone
 material: Solid Brass

Brass Class
 100% Ottone



320 MS R46 LV



320 MS R46 OC



320 MS R46 OSC



320 MS R46 BG

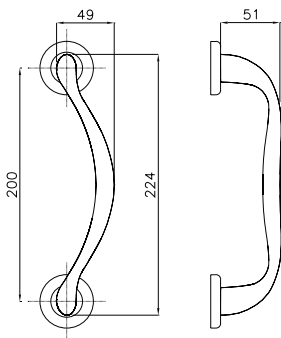

320 MS 007 OSC





320 MS 003 LV

VERSIONI / VERSIONS



Finiture
 Finishes

MANIGLIONE SPOSTATO SINGOLO / SINGLE OFF CENTRE PULL HANDLE

						LV BG	OSC OC	BGO	PVD	
320 MS 003	Maniglione Singolo con rosetta Single Pull Handle on rose	003	mm Ø45x7		F	•	•			2
320 MS 007	Maniglione Singolo con rosetta Single Pull Handle on rose	007	mm 67x27	ovale stretta oval and reduced	F	•	•			2
320 MS R46	Maniglione Singolo con rosetta Single Pull Handle on rose	R46	mm Ø46x8	tipo lusso lusso type	F	•	•		•	2
320 MS 004	Maniglione Singolo con rosetta Single Pull Handle on rose	004	mm Ø45X9		F			•	•	2
320 MS 006	Maniglione Singolo con rosetta Single Pull Handle on rose	006	mm Ø50x8	tipo lusso lusso type	F			•		2

art. 327 EDEN

design: Studio Reguitti
 materiale: Ottone
 material: Solid Brass

Brass Class
 100% Ottone



327 MS - LV



327 MS - OSC

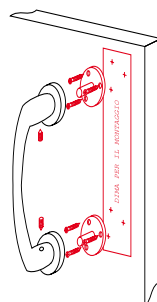
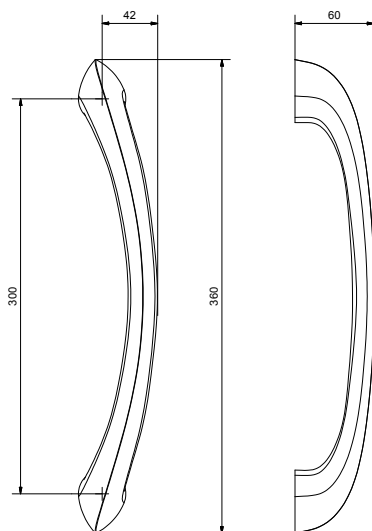

TIPO **P**

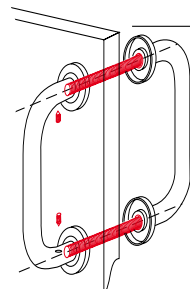

TIPO **AC**

VERSIONI / VERSIONS



Finiture
 Finishes



LV
 BG

OSC
 OC

PVD

PVD INOX



MANIGLIONE SPOSTATO / OFF CENTRE PULL HANDLE

327 MS

Maniglione singolo
 Single pull handle

P

•

•

•

•

1

327 LS

Maniglione accoppiato per legno
 Pair pull handle for wood door

AC

•

•

•

•

1

327 MV

Maniglione accoppiato per vetro
 Pair pull handle for glass door

AC

•

•

•

•

1

art. 334 ALMA 25

design: Marco Pialorsi
 materiale: Ottone
 material: Solid Brass

Brass Class
 100% Ottone



334 MS R46 OSC



334 MS R46 OC



334 MS R46 LV

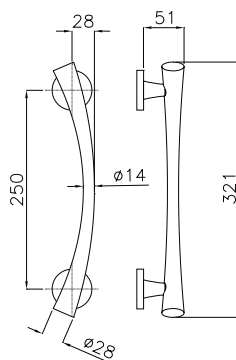



VERSIONI / VERSIONS



Finiture
 Finishes

MANIGLIONE SPOSTATO SINGOLO / SINGLE OFF CENTRE PULL HANDLE

					LV	OC OSC	PVD	
334 MS	Maniglione Singolo, inclusi accessori per montaggio singolo (tipo P) e accoppiato per legno e vetro (tipo AC). Single Pull Handle, including accessories for single (type P) and back to back (type AC) pull handle, on wooden and glass doors			P-AC	•	•	•	1
334 MS R46	Maniglione Spostato Singolo con rosetta Single Off Centre Pull Handle on rose	R46	mm ø46x8	F	•	•	•	1
334 LS R46	Maniglione Accoppiato per legno con rosetta Pair Pull Handle for wood doors on rose	R46	mm ø46x8	AC	•	•	•	1
334 MV R46	Maniglione Accoppiato per vetro con rosetta Pair Pull Handle for glass doors on rose	R46	mm ø46x8	AC	•	•	•	1

art. 330 SUN 30

design: Marco Pialorsi
 materiale: Ottone
 material: Solid Brass

Brass Class
 100% Ottone

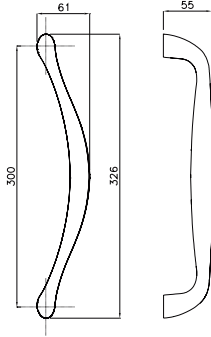

330 MS - LV



330 MS - OC



330 MS - OSC



330 MS BG

TIPO P

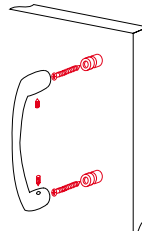

TIPO AC

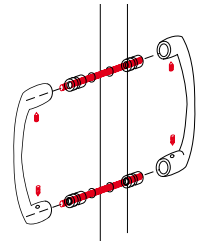

con vite autofilettante DIN 7982 adatta a porte in legno/alluminio/pvc with self-threading screw - DIN 7982, suitable for Wooden, Aluminium and Pvc doors

VERSIONI / VERSIONS



Finiture
 Finishes



LV
 BG

OSC
 OC

PVD

PVD
 INOX



MANIGLIONE SPOSTATO SINGOLO / SINGLE OFF CENTRE PULL HANDLE

330 MS Maniglione Singolo.
 Inclusi accessori per montaggio singolo (tipo P) e accoppiato per legno e vetro (tipo AC).

P - AC

•

•

•

•

1

Single Pull Handle, including accessories for single (type P) and back to back (type AC) pull handle, on wooden and glass doors

art. 330 SUN 30

design: Marco Pialorsi
materiale: Ottone
material: Solid Brass

Brass Class
100% Ottone



330 MS 006 BG



330 MS 006 LV



330 MS 006 OC



330 MS 006 OSC

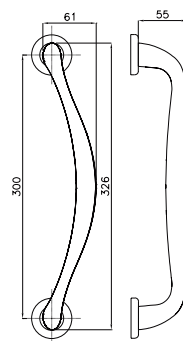

VERSIONI / VERSIONS



Finiture
Finishes



LV
BG

OSC
OC

PVD

PVD
INOX



MANIGLIONE SPOSTATO SINGOLO / SINGLE OFF CENTRE PULL HANDLE

330 MS 002	Maniglione Singolo con rosetta Single Pull Handle on rose	002	mm Ø45x10 con piastrina with fixing base	P	•	•	•	•	1
330 MS 006	Maniglione Singolo con rosetta Single Pull Handle on rose	006	mm Ø50x8 tipo lusso luxury type	F	•	•	•	•	1

MANIGLIONE SPOSTATO ACCOPPIATO PER LEGNO / PAIR OFF CENTRE PULL HANDLE FOR WOOD DOORS

330 LS 002	Maniglione Accoppiato per legno con rosetta Pair Pull Handle for wood doors on rose	002	mm Ø45x10	AC	•	•	•	•	1
330 LS 006	Maniglione Accoppiato per legno con rosetta Pair Pull Handle for wood doors on rose	006	mm Ø50x8 tipo lusso luxury type	AC	•	•	•	•	1

art. 335 ARCHI25

design: Marco Pialorsi
 materiale: Ottone
 material: Solid Brass

Brass Class
 100% Ottone



335 MS - LV

TIPO **P**

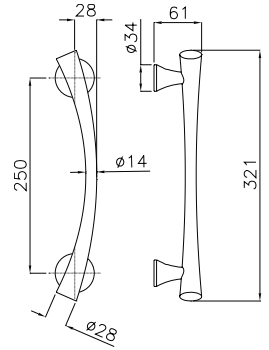
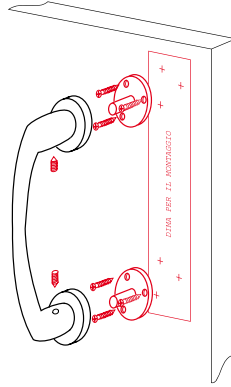

335 MS - OC



335 MS - OSC

VERSIONI / VERSIONS



Finiture
 Finishes



LV

OC
 OSC

PVD



MANIGLIONE SPOSTATO SINGOLO / SINGLE OFF CENTRE PULL HANDLE

335 MS	Maniglione Singolo Single Pull Handle	P	•	•	•	1
--------	--	---	---	---	---	---

MANIGLIONE SPOSTATO ACCOPPIATO PER LEGNO / PAIR OFF CENTRE PULL HANDLE FOR WOOD DOORS

335 LS	Maniglione Accoppiato per legno Pair Pull Handle for wood doors	AC	•	•	•	1
--------	--	----	---	---	---	---

MANIGLIONE SPOSTATO ACCOPPIATO PER VETRO / PAIR OFF CENTRE PULL HANDLE FOR GLASS DOORS

335 MV	Maniglione Accoppiato per vetro Pair Pull Handle for glass doors	AC	•	•	•	1
--------	---	----	---	---	---	---

art.338 MONACO 205

design: Studio Reguitti
 materiale: Ottone
 material: Solid Brass

Brass Class
 100% Ottone

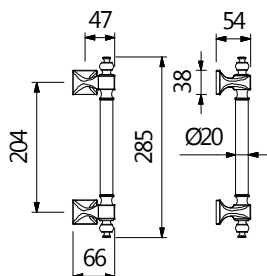

338 MS - BG

art.339 MONACO 300

design: Studio Reguitti
 materiale: Ottone
 material: Solid Brass

Brass Class
 100% Ottone

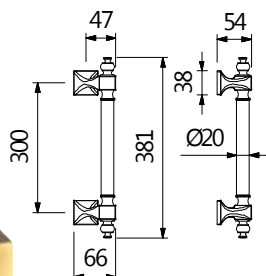

339 MS - BG

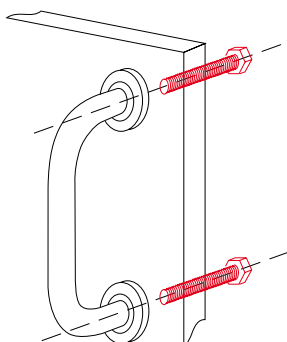

TIPO T

SISTEMA DI MONTAGGIO
 MOUNTING SYSTEM

VERSIONI / VERSIONS



Finiture
 Finishes

LV
 BG

PVD
 PVD
 INOX

VBN

AGV

AN



MANIGLIONE SPOSTATO / OFF CENTRE PULL HANDLE

338 MS 000

Maniglione singolo
 Single pull handle

T

€

€

€

€

€

1

339 MS 000

Maniglione singolo
 Single pull handle

T

€

€

€

€

€

1

art. 351 MAYA 205

design: Studio Reguitti
 materiale: Ottone
 material: Solid Brass

Brass Class
 100% Ottone

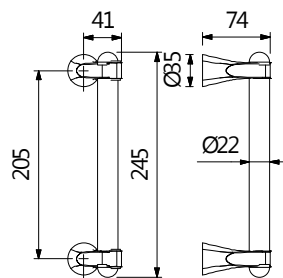

351 MS - PVD INOX

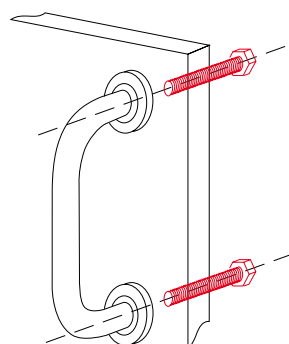

TIPO T
 SISTEMA DI MONTAGGIO
 MOUNTING SYSTEM

VERSIONI / VERSIONS



Finiture
 Finishes

LV
 BG

OC
 OSC

PVD
 PVD INOX

MANIGLIONE SPOSTATO / OFF CENTRE PULL HANDLE

351 MS 000

Maniglione singolo
 Single pull handle

T

€

€

€

•

•

•

1

art. 355 MAYA 300

design: Studio Reguitti
 materiale: Ottone
 material: Solid Brass

Brass Class
 100% Ottone

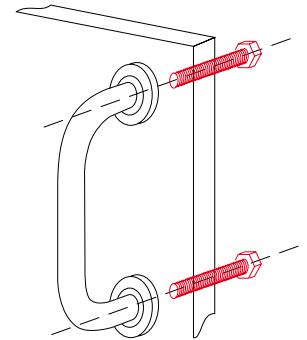
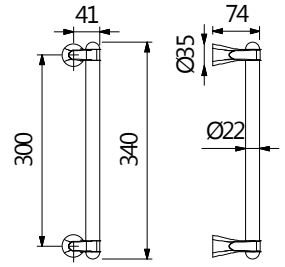

TIPO T
 SISTEMA DI MONTAGGIO
 MOUNTING SYSTEM

355 MS - PVD INOX

VERSIONI / VERSIONS



Finiture
Finishes

LV
BG

OC
OSC

PVD
PVD INOX 

MANIGLIONE SPOSTATO / OFF CENTRE PULL HANDLE

355 MS 000

Maniglione singolo
Single pull handle

T

€

€

€

•

•

•

1

art. 353 RUBENS

design: Studio Reguitti
 materiale: Ottone
 material: Solid Brass

Brass Class
 100% Ottone

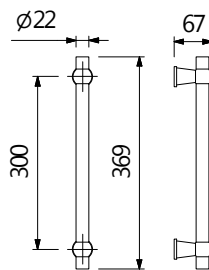

353 MD - BG



353 MD - PVD MATT SILVER

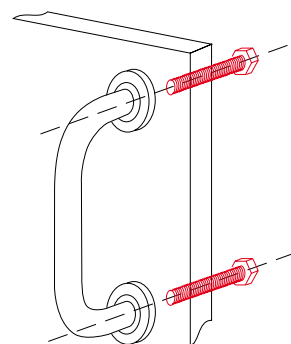

T

SISTEMA DI MONTAGGIO
 MOUNTING SYSTEM

VERSIONI / VERSIONS



Finiture
 Finishes

PVD MATT SILVER

LV
 BG



MANIGLIONE DIRITTO SINGOLO / SINGLE STRAIGHT PULL HANDLE

353 MD ***

Maniglione diritto singolo
 Single straight pull handle

T

€

•

€

•

1

art. 425 QUARK 25

design: Studio Reguitti
 materiale: Ottone
 material: Solid Brass

Brass Class
 100% Ottone

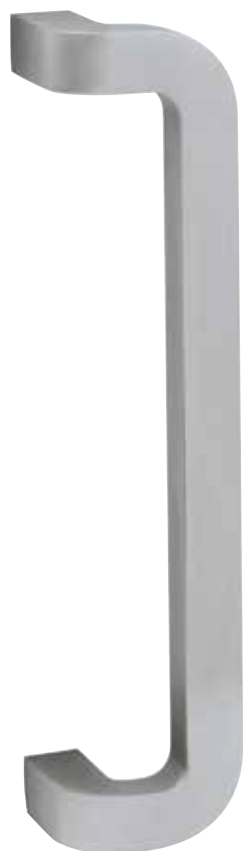

425 MS - OSC



425 MS Q02 - OSC

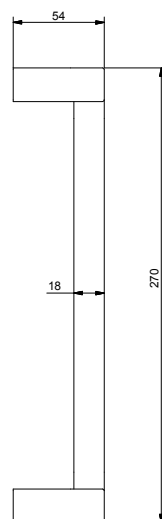
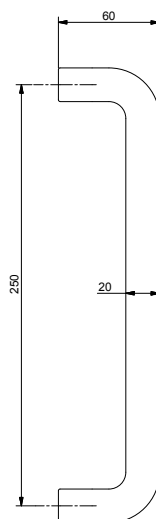

PER: 425 MS

PER: 425 LS Q02

TIPO **AC**

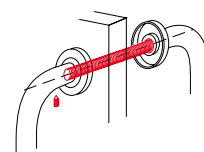
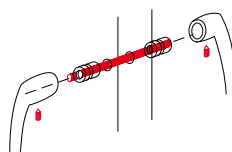

TIPO **P**

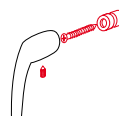

PER: 425 MS Q02

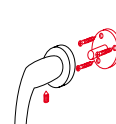

con vite autofilettante DIN 7982 adatta a porte in legno/
 alluminio/pvc
 with self-threading screw - DIN 7982, suitable for
 Wooden, Aluminium and Pvc doors

VERSIONI / VERSIONS



Finiture
 Finishes



LV

OSC
 OC



MANIGLIONE SPOSTATO / OFF CENTRE PULL HANDLE

425 MS	Maniglione singolo inclusi accessori per il montaggio singolo per legno (montaggio P) e accoppiato per legno e vetro (montaggio AC) <i>Single pull handle, including accessories for single on wood door (type P) and back to back (type AC) pull handle, on wooden and glass door</i>	P-AC	•	•	1
425 MS Q02	Maniglione Singolo con rosetta Q02 mm 45X45 <i>Single pull handle on rose Q02 mm 45X45</i>	P	•	•	1
425 LS Q02	Maniglione Accoppiato con rosetta Q02 mm 45X45 <i>Pair pull handle on rose Q02 mm 45X45</i>	AC	•	•	1

serie

LASER 20-30-40-60

design: Studio Reguitti
materiale: Ottone
material: Solid Brass

Brass Class
100% Ottone



130 MD 005 OSC

331 MD 005 OSC

341 MD 005 OSC

361 MD 005 OSC

art. 130 LASER 20



LV

OC
OSC



MANIGLIONE DA mm200									
130 MD 005	Maniglione Singolo con rosetta Single Pull Handle on rose	005	mm Ø50x8	tipo lusso lusso type	F	•	•2	•	1
130 LD 005	Maniglione Accoppiato per legno con rosetta Pair Pull Handle for wood doors on rose	005	mm Ø50x8	tipo lusso lusso type	AC	•	•	•	1
130 MV 005	Maniglione Accoppiato per vetro con rosetta Pair Pull Handle for glass doors on rose	005	mm Ø50x8	tipo lusso lusso type	AC	•2	•	•	1

art. 331 LASER 30



MANIGLIONE DA mm300									
331 MD 005	Maniglione Singolo con rosetta Single Pull Handle on rose	005	mm Ø50x8	tipo lusso lusso type	F	•	•	•	1
331 LD 005	Maniglione Accoppiato per legno con rosetta Pair Pull Handle for wood doors on rose	005	mm Ø50x8	tipo lusso lusso type	AC	•	•	•	1
331 MV 005	Maniglione Accoppiato per vetro con rosetta Pair Pull Handle for glass doors on rose	005	mm Ø50x8	tipo lusso lusso type	AC	•	•	•	1

art. 341 LASER 40



MANIGLIONE DA mm400									
341 MD 005	Maniglione Singolo con rosetta Single Pull Handle on rose	005	mm Ø50x8	tipo lusso lusso type	F	•	•	•	1
341 LD 005	Maniglione Accoppiato per legno con rosetta Pair Pull Handle for wood doors on rose	005	mm Ø50x8	tipo lusso lusso type	AC	•	•	•	1
341 MV 005	Maniglione Accoppiato per vetro con rosetta Pair Pull Handle for glass doors on rose	005	mm Ø50x8	tipo lusso lusso type	AC	•2	•	•	1

art. 361 LASER 60



MANIGLIONE DA mm600									
361 MD 005	Maniglione Singolo con rosetta Single Pull Handle on rose	005	mm Ø50x8	tipo lusso lusso type	F	•	•	•	1
361 LD 005	Maniglione Accoppiato per legno con rosetta Pair Pull Handle for wood doors on rose	005	mm Ø50x8	tipo lusso lusso type	AC	•	•	•	1
361 MV 005	Maniglione Accoppiato per vetro con rosetta Pair Pull Handle for glass doors on rose	005	mm Ø50x8	tipo lusso lusso type	AC	•	•	•	1



130 MD 005 OC

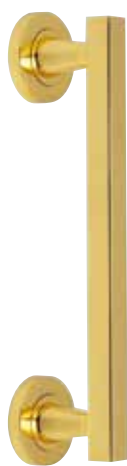

130 MD 005 LV

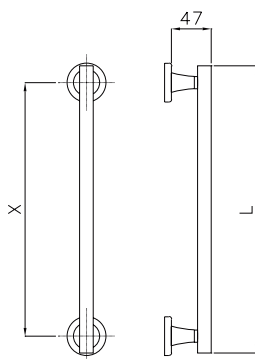

art.	X	L
130	200	240
331	300	340
341	400	460
361	600	680

serie **LASER 20-30**

design: Studio Reguitti
 materiale: Ottone
 material: Solid Brass

Brass Class
 100% Ottone



130 MD - OSC



331 MD - OSC



130 MD Q50 OSC



331 MD Q50 OSC

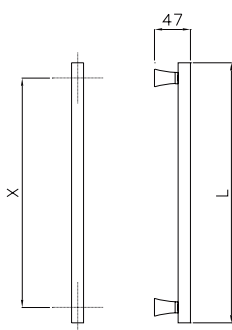

art.	X	L
130	200	240
331	300	340



130 MD OC



130 MD LV

art. 130 LASER 20



LV

OC
OSC



MANIGLIONE DA mm200							
130 MD	Maniglione Singolo. Inclusi accessori per montaggio singolo (tipo P) e accoppiato per legno e vetro (tipo AC).			P-AC	•	•	1
Single Pull Handle, including accessories for single (type P) and back to back (type AC) pull handle, on wooden and glass doors							
130 MD Q50	Maniglione Singolo con rosetta Single Pull Handle on rose	Q50 mm 50x50	con piastrina with fixing base	P	•	•	1
130 MD 002	Maniglione Singolo con rosetta Single Pull Handle on rose	002 mm Ø45X10	con piastrina with fixing base	P	•	•	1
130 LD Q50	Maniglione accoppiato per legno con rosetta Pair Pull Handle for wood doors on rose	Q50 mm 50x50		AC	•	•	1



art. 131 LASER 30

MANIGLIONE DA mm300							
331 MD	Maniglione Singolo. Inclusi accessori per montaggio singolo (tipo P) e accoppiato per legno e vetro (tipo AC).			P-AC	•	•	1
Single Pull Handle, including accessories for single (type P) and back to back (type AC) pull handle, on wooden and glass doors							
331 MD Q50	Maniglione Singolo con rosetta Single Pull Handle on rose	Q50 mm 50x50	con piastrina with fixing base	P	•	•	1
331 MD 002	Maniglione Singolo con rosetta Single Pull Handle on rose	002 mm Ø45X10	con piastrina with small plate	P	•	•	1
331 LD Q50	Maniglione accoppiato per legno con rosetta Pair Pull Handle for wood doors on rose	Q50 mm 50x50		AC	•	•	1

PER:
130 MD, 331 MD

TIPO **AC**

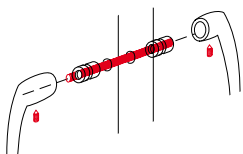

TIPO **P**

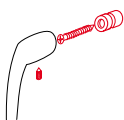

PER:
130 LD Q50, 331 LD Q50

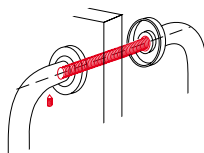

PER:
130MDQ50, 130MD002
331MDQ50, 331MD002

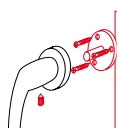

130 MD 002 OSC
331 MD 002 OSC

con vite autofilettante DIN 7982 adatta a porte in legno/alluminio/pvc
with self-threading screw - DIN 7982,
suitable for Wooden,
Aluminium and Pvc doors

serie LASER Q20-Q30

design: Studio Reguitti
 materiale: Ottone
 material: Solid Brass

Brass Class
 100% Ottone



423 MD - OSC



433 MD - OSC



423 MD Q50 OSC

433 MD Q50 OSC

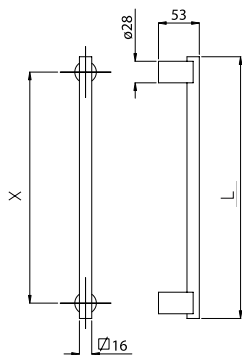

art.	X	L
423	200	240
433	300	340

art. 423 LASER Q20



MANIGLIONE DA mm200							
423 MD	Maniglione Singolo. Inclusi accessori per montaggio singolo (tipo P) e accoppiato per legno e vetro (tipo AC).			P-AC	•	•	1
Single Pull Handle, including accessories for single (type P) and back to back (type AC) pull handle, on wooden and glass doors							
423 MD Q50	Maniglione Singolo con rosetta Single Pull Handle on rose	Q50	mm 50x50	P	•	•	1
423 MD 002	Maniglione Singolo con rosetta Single Pull Handle on rose	002	mm Ø45x10 con piastrina with fixing base	P	•	•	1
423 LD Q50	Maniglione Accoppiato per legno con rosetta Pair Pull Handle for wood doors on rose	Q50	mm 50x50	AC	•	•	1
423 LD 002	Maniglione Accoppiato per legno con rosetta Pair Pull Handle for wood doors on rose	002	mm Ø45x10	AC	•	•	1

art. 433 LASER Q30



MANIGLIONE DA mm300							
433 MD	Maniglione Singolo. Inclusi accessori per montaggio singolo (tipo P) e accoppiato per legno e vetro (tipo AC).			P-AC	•	•	1
Single Pull Handle, including accessories for single (type P) and back to back (type AC) pull handle, on wooden and glass doors							
433 MD Q50	Maniglione Singolo con rosetta Single Pull Handle on rose	Q50	mm 50x50	P	•	•	1
433 MD 002	Maniglione Singolo con rosetta Single Pull Handle on rose	002	mm Ø45x10 con piastrina with fixing base	P	•2	•	1
433 LD Q50	Maniglione Accoppiato per legno con rosetta Pair Pull Handle for wood doors on rose	Q50	mm 50x50	AC	•	•	1
433 LD 002	Maniglione Accoppiato per legno con rosetta Pair Pull Handle for wood doors on rose	002	mm Ø45x10	AC	•	•	1

PER:
423 MD, 433 MD

TIPO **AC**

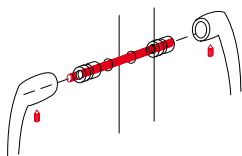

TIPO **P**

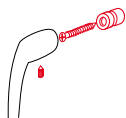

con vite autofilettante DIN 7982 adatta a porte in legno/alluminio/pvc
with self-threading screw - DIN 7982, suitable for Wooden, Aluminium and Pvc doors

PER:
423 LD Q50, 423 LD 002,
433 LD Q50, 433 LD 002

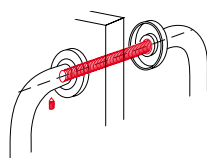

PER:
423MDQ50, 423MD002
433MDQ50, 433MD002

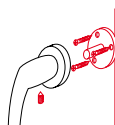

423 MD 002 OSC

serie

RIGO 30-40-60

design: Studio Reguitti
materiale: Ottone
material: Solid Brass

Brass Class
100% Ottone



332 MD - OSC



342 MD - OSC



362 MD - OSC

art. 332 RIGO 30



LV

OC
OSC



MANIGLIONE DA mm300					
332 MD	Maniglione Singolo Single Pull Handle	P	•	•	1
332 LD	Maniglione Accoppiato per legno Pair Pull Handle for wood doors	AC	•	•	1
332 MV	Maniglione Accoppiato per vetro Pair Pull Handle for glass doors	AC	•	•	1

art. 342 RIGO 40



MANIGLIONE DA mm400					
342 MD	Maniglione Singolo Single Pull Handle	P	•	•	1
342 LD	Maniglione Accoppiato per legno Pair Pull Handle for wood doors	AC	•	•	1
342 MV	Maniglione Accoppiato per vetro Pair Pull Handle for glass doors	AC	•	•	1

art. 362 RIGO 60



MANIGLIONE DA mm600					
362 MD	Maniglione Singolo Single Pull Handle	P	•	•	1
362 LD	Maniglione Accoppiato per legno Pair Pull Handle for wood doors	AC	•	•	1
362 MV	Maniglione Accoppiato per vetro Pair Pull Handle for glass doors	AC	•	•	1



342 MD - LV



342 MD - OC

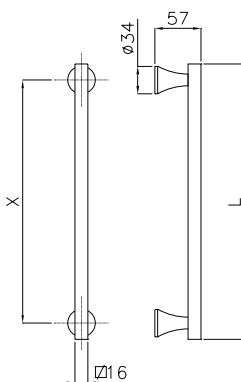

art.	X	L
332	300	340
342	400	460
362	600	680

TIPO P

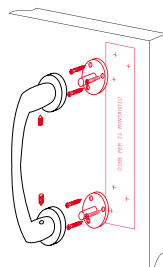

AC

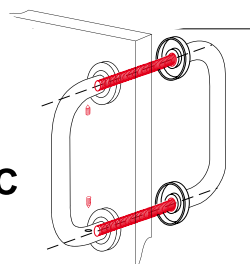

BATTENTI DOOR KNOCKER



TIPI DI INSTALLAZIONE INSTALLATION

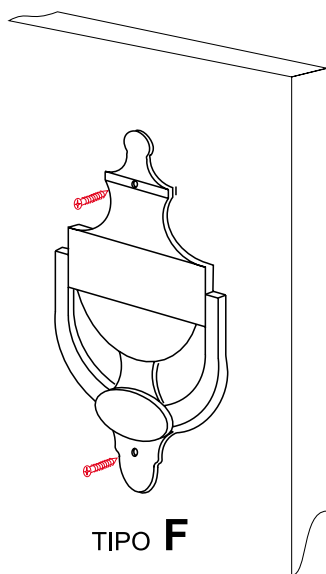
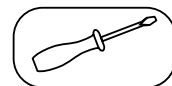

TIPO **F**

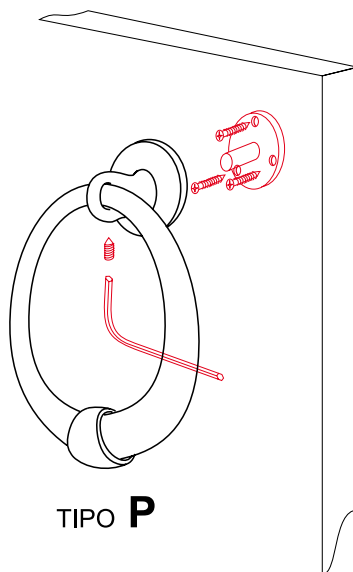

TIPO **P**

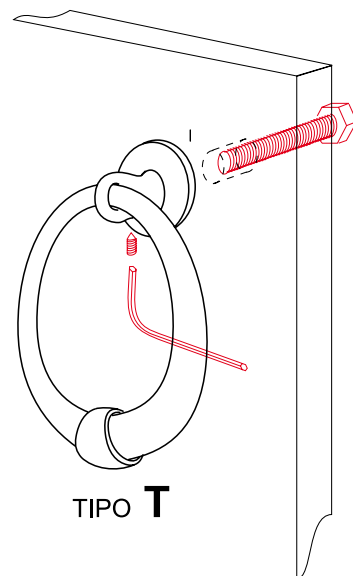

TIPO **T**

A RICHIESTA / ON REQUEST: (per montaggio tipo T)

art. CD 265/275



CD 265 Set con due tronconi M8x80 - 2 rond.ferro - 2 dadi M8 | 0,94 €
 CD 275 Set con due tronconi M10x80 - 2 rond.ferro - 2 dadi M10 | 1,34 €



art. CD 276/277



OTTONE CROMATO

OTTONE GREZZO

CD 276 Set con due tronconi M8x80 - 2 dadi ciechi M8
 CD 277 Set con due tronconi M10x80 - 2 dadi ciechi M10

	OTT. GREZZO	OTT. CROMATO
CD 276	•	•
CD 277	•	•



art. **6 GIOVE**

design: Marco Pialorsi
 materiale: Ottone
 material: Solid Brass

Brass Class
 100% Ottone

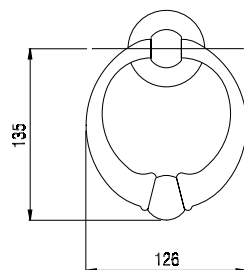

6 BA 60R LV



6 BA 002 PVD



6 BA 60R BG



6 BA 60R OSC



6 BA 73R AN



6 BA 002 PVD INOX

VERSIONI / VERSIONS



					LV BG	OC OSC	AN	AGV	PVD	PVD INOX	
6 BA 002	Battente con rosetta Door Knocker on rose	002	mm Ø45x10	P	•	•			•	•	1
6 BA 60R	Battente con rosetta Door Knocker on rose	60R	mm Ø60x9	P	•	•			•		1
6 BA 73R	Battente con rosetta Door Knocker on rose	73R	mm Ø72x9	P			•	•			1

art. 7 EUROPA

design: Marco Pialorsi
 materiale: Ottone
 material: Solid Brass

Brass Class
 100% Ottone



7 BA 60R LV

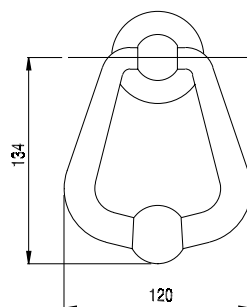

7 BA 002 PVD



7 BA 60R BG



7 BA 60R OSC



7 BA 73R AGV



7 BA 73R AN

VERSIONI / VERSIONS



					LV BG	OSC	NC	AN	AGV	PVD	
7 BA 002	Battente con rosetta Door Knocker on rose	002	mm Ø45x10	P	•	•				•	1
7 BA 60R	Battente con rosetta Door Knocker on rose	60R	mm Ø60x9	P	•	•				•	1
7 BA R56	Battente con rosetta Door Knocker on rose	R56	mm Ø70x7	P			•				1
7 BA 73R	Battente con rosetta Door Knocker on rose	73R	mm Ø72x9	P				•	•		1

art. **8** ANELLO

materiale: Ottone
material: Solid Brass

Brass Class
100% Ottone



8 BA 011 LV

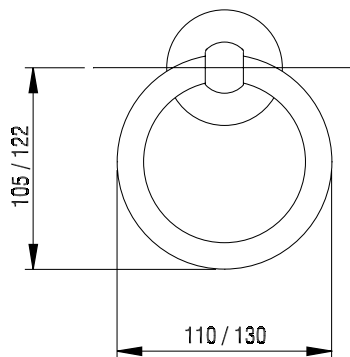

8 BA 013 BG



8 BA 013 OSC

VERSIONI / VERSIONS



LV BG

OSC



8 BA 011 Battente mm Ø110 con rosetta R80 mm Ø80x7
Door Knocker mm Ø110 on rose

P

•

•

1

8 BA 013 Battente mm Ø130 con rosetta R80 mm Ø80x7
Door Knocker mm Ø130 on rose

P

•

•

1

art. **9** VICTORIAN

materiale: Ottone
material: Solid Brass

Brass Class
100% Ottone

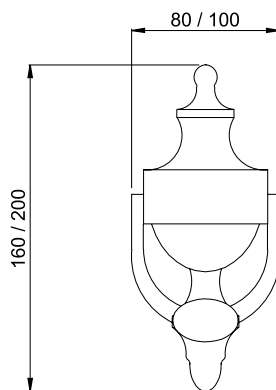

9 BA 020 LV

VERSIONI / VERSIONS



LV



9 BA 016	Battente Door Knocker	mm 160x80	con fori viti with holes for screws
9 BA 020	Battente Door Knocker	mm 200x100	con fori viti with holes for screws

F

•

4

F

•

4

art. **10** BAROCCO

materiale: Ottone
material: Solid Brass

Brass Class
100% Ottone

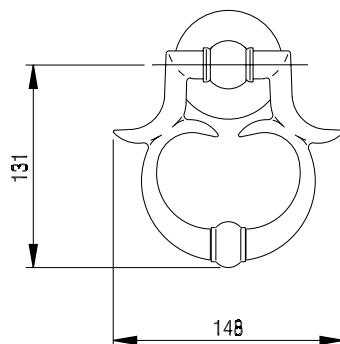

10 BA R80 LV



10 BA R80 BG

VERSIONI / VERSIONS



LV

BG



10 BA R80

Battente con rosetta
Door Knocker on rose

R80

mm Ø80x7

P

•

1

art. 13 HELIOS

design: Marco Pialorsi
 materiale: Ottone
 material: Solid Brass

Brass Class
 100% Ottone



13 BA 73R LV

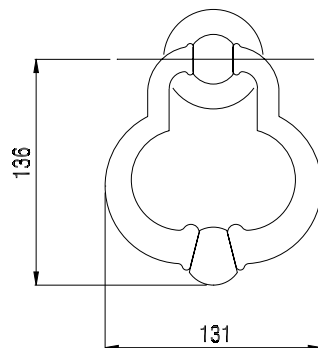

13 BA 002 PVD



13 BA 73R AGV



13 BA 73R AN



13 BA 73R BG



13 BA 73R VBN

VERSIONI / VERSIONS



LV
BG

AN

AGV

PVD

VBN



13 BA 002	Battente con rosetta Door Knocker on rose	002	mm Ø45x10	P				•		1
13 BA 60R	Battente con rosetta Door Knocker on rose	60R	mm Ø60x9	P				•		1
13 BA 73R	Battente con rosetta Door Knocker on rose	73R	mm Ø72x9	P	•	•	•		•	1

art. 14 LEONE

materiale: Ottone
material: Solid Brass

Brass Class
100% Ottone



14 BA LV

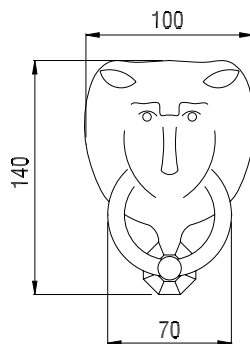

14 BA OB



14 BA AGV



14 BA AN



VERSIONI / VERSIONS

BATTENTE / DOOR KNOCKER

14 BA ***

Battente
Door knocker



	LV OB	AN	AGV	
T	•	•	•	4

art. 356 LYON

design: Studio Reguitti
 materiale: Ottone
 material: Solid Brass

Brass Class
 100% Ottone

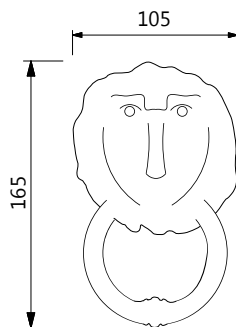

356 BA - BG



356 BA - VBN

VERSIONI / VERSIONS



Finiture
Finishes

LV
BG

VBN



BATTENTE / DOOR KNOCKER

356 BA ***

Battente
Door knocker

F

€

29,50

€

28,50

1

art. 124 Q-ARTE

design: Studio Reguitti
 materiale: Ottone
 material: Solid Brass

MODELLO DEPOSITATO
 REGISTERED MODEL

Brass Class
 100% Ottone



124 BA - OSC

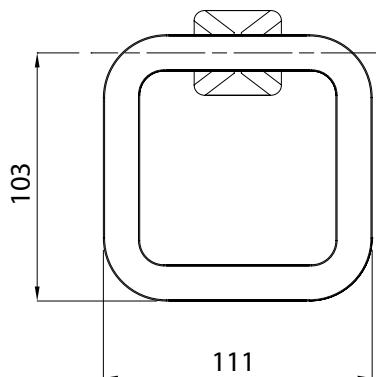

VERSIONI / VERSIONS



Finiture
 Finishes



LV

OSC



124 BA

Battente
 Door Knocker

P

•

•

1

POMOLI KNOBS



TIPI DI INSTALLAZIONE INSTALLATION

PF

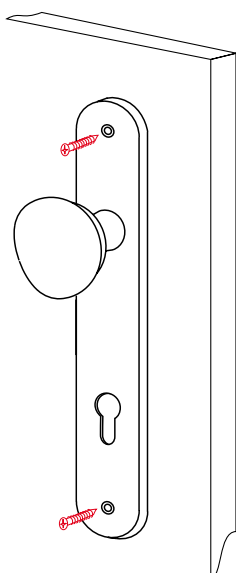
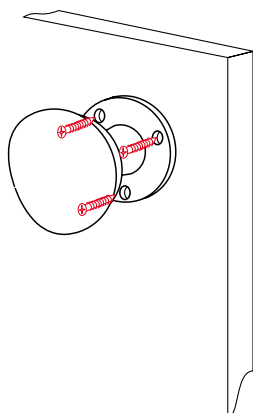
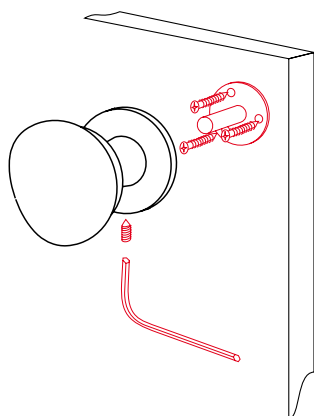

PO

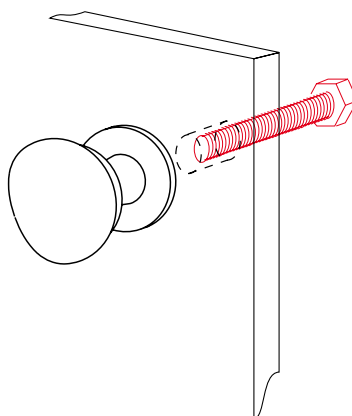

A RICHIESTA / ON REQUEST: (per montaggio tipo PO)

art. CD 265/275



CD 265 Set con due tronconi M8x80 - 2 rond.ferro - 2 dadi M8
CD 275 Set con due tronconi M10x80 - 2 rond.ferro - 2 dadi M10

art. CD 276/277



OTTONE CROMATO



OTTONE GREZZO



CD 276 Set con due tronconi M8x80 - 2 dadi ciechi M8
CD 277 Set con due tronconi M10x80 - 2 dadi ciechi M10

	OTT. GREZZO	OTT. CROMATO
CD 276	•	•
CD 277	•	•

406 rosetta info tecniche

NUOVE COPPIE POMOLO CON ROSETTA 406 Ø45

- **MIGLIORE ESTETICA:** Scompare il Nylon in vista

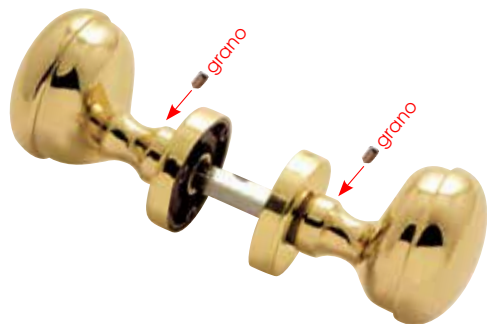

Esempio: cod. 345PR406 - LV

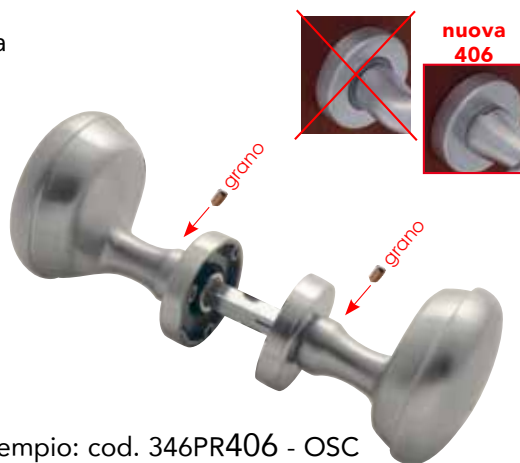

Esempio: cod. 346PR406 - OSC

- **NUOVA FUNZIONALITA' POSSIBILITA' DI TRASFORMARLI IN:**
pomolo fisso

mediante l'aggiunta della
piastrina P2 al posto
della sottorosetta in nylon



cod. 345PF002 LV



cod. 346PF002 OSC

- oppure in guarnitura composta da:

mezza coppia pomolo/mezza maniglia girevole da un lato
e pomolo fisso dall'altro, uniti mediante ferro F04QB (lunghezza da specificare).

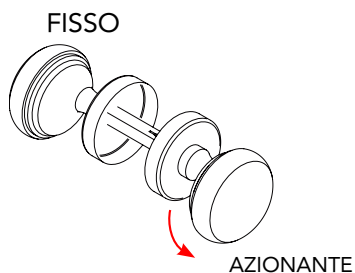

cod. F04QB

Sistema applicabile a tutte le coppie pomolo.

art. 48 OVUM

Brass Class
100% Ottone

POMOLI FISSI/FIXED KNOBS

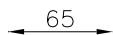

48 PF 006 - LV



48 PF 037 - LV



48 PF 248 - LV



48 PF 009 - BG



48 PF C07 - OC



48 PF R50 - OSC



48 PF 002 - OS



48 PF 006 - AN

VERSIONI / VERSIONS



Finiture
Finishes

POMOLO SU ROSETTA CON FISSAGGIO A PIASTRINA / KNOB ON ROSE WITH FIXING BASE

				LV BG OS	OC OSC	AN	
48 PF R50	Pomolo Fisso con rosetta Fixed Knob on rose	R50	mm Ø50x9 con piastrina with fixing base	•	•	•	4
48 PF 002	Pomolo Fisso con rosetta Fixed Knob on rose	002	mm Ø45x10 con piastrina with fixing base	•	•		4
48 PF 006	Pomolo Fisso con rosetta Fixed Knob on rose	006	mm Ø50x8 tipo lusso con piastrina lusso type with fixing base	•	•	•	4
48 PF C07	Pomolo Fisso con rosetta Fixed Knob on rose	C07	mm 67x27 ovale stretta con piastrina oval and reduced with fixing base	•	•		4
48 PF 009	Pomolo Fisso con rosetta Fixed Knob on rose	009	mm 62x32 ovale con piastrina oval with fixing base	•	•	•	4

POMOLO SU PLACCA / KNOB ON PLATE

48 PF 037	Pomolo Fisso con placca Fixed Knob on plate	037	mm 255x42 yale yale	•	•	•	2
48 PF 248	Pomolo Fisso con placca Fixed Knob on plate	248	mm 248x50 yale yale	•	•		2

art. 48 OVUM

Brass Class POMOLI GIREVOLI/DOOR KNOBSETS
100% Ottone



48 PR 406 - OSC



48 PP 248 - LV

VERSIONI / VERSIONS



Finiture
Finishes

SU ROSETTA / ON ROSE

					LV	BG	OC	OS	OSC	
	48 PR 003	Coppia Pomolo con rosetta Pair Knob on rose	003	mm Ø45x7	con grano with grub screw	•	•			2
	48 PR 006	Coppia Pomolo con rosetta Pair Knob on rose	006	mm Ø50x8	tipo lusso con grano lusso type with grub screw	•	•			2
	48 PR 009	Coppia Pomolo con rosetta Pair Knob on rose	009	mm 62x32	con grano with grub screw	•	•			2
	48 PR 406	Coppia Pomolo con rosetta Pair Knob on rose	406	mm Ø45x9	con grano with grub screw	•	•			

SU PLACCA / ON PLATE

	48 PP 037	Coppia Pomolo con placca Pair Knob on plate	037	mm 255x42	con grano with grub screw	•	•			1
	48 PP 248	Coppia Pomolo con placca Pair Knob on plate	248	mm 248x50	con grano with grub screw	•	•			1

- Specificare se foro chiave normale o yale
Please specify hole for key: yale (europrofile cylinder) or patent/normal

A RICHIESTA / ON REQUEST:

- Mezza coppia pomolo con rosetta o con placca / Half pair knob on rose or plate
- Coppia pomolo con rosetta senza bocchetta / Pair knob on rose without rose for key



art. 50 **SEMPLICE**

Brass Class 100% Ottone **POMOLI FISSI/FIXED KNOBS**

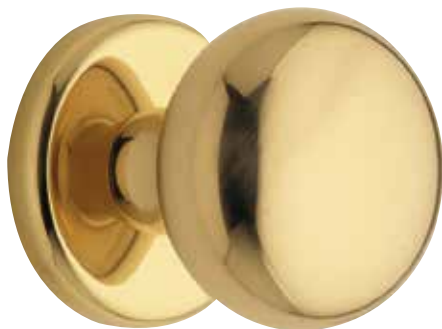
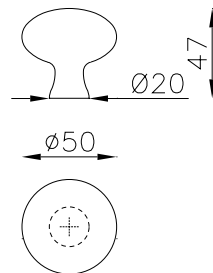

C50 PF R50 - LV



C50 PF 037 - LV



C50 PF 248 - LV



C50 PF 628 - OC

VERSIONI / VERSIONS



Finire
Finishes

					LV BG	OC OSC		
POMOLO SU ROSETTA CON FISSAGGIO A PIASTRINA / KNOB ON ROSE WITH FIXING BASE								
	C50 PF R50	Pomolo Fisso con rosetta Fixed Knob on rose	R50	mm Ø50x9	con piastrina with fixing base	•	•	4
	C50 PF 002	Pomolo Fisso con rosetta Fixed Knob on rose	002	mm Ø45x10	con piastrina with fixing base	•	•	4
	C50 PF 006	Pomolo Fisso con rosetta Fixed Knob on rose	006	mm Ø50x9	tipo lusso con piastrina lusso type with fixing base	•	•	4
POMOLO SU ROSETTA CON FISSAGGIO VITI A VISTA / KNOB ON ROSE WITH SCREW FIXING								
	C50 PF F56	Pomolo Fisso con rosetta Fixed Knob on rose	F56	mm Ø70x7	fissa con 3 fori viti with 3 holes for screws	•	•	4
	C50 PF 628	Pomolo Fisso con rosetta Fixed Knob on rose	628	mm Ø60x11	fissa con 3 fori viti with 3 holes for screws	•	•	4
POMOLO SU PLACCA / KNOB ON PLATE								
	C50 PF 037	Pomolo Fisso con placca Fixed Knob con plate	037	mm 255x42	yale yale	•	•2	2
	C50 PF 248	Pomolo Fisso con placca Fixed Knob con plate	248	mm 248x50	yale yale	•	•	2



C50 PF 002 - OSC



C50 PF 006 - OSC



C50 PF 002 - BG

art. **52** **SICUR**

Brass Class 100% Ottone **POMOLI FISSI/FIXED KNOBS**

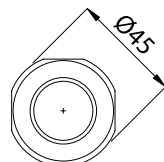
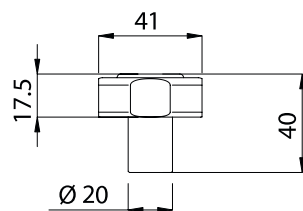

B52 PF R50 - LV



B52 PF 002 - OC



B52 PF 60R - BG



B52 PF R50 - OSC

VERSIONI / VERSIONS



Finiture
Finishes

POMOLO SU ROSETTA CON FISSAGGIO A PIASTRINA / KNOB ON ROSE WITH FIXING BASE

B52 PF R50 Pomolo Fisso Ø 45 con rosetta R50 mm Ø50x9 con piastrina
Fixed Knob Ø 45 on rose with fixing base

B52 PF 002 Pomolo Fisso Ø 45 con rosetta 002 mm Ø45x10 con piastrina
Fixed Knob Ø 45 on rose with fixing base

B52 PF 60R Pomolo Fisso Ø 45 con rosetta 60R mm Ø60x9 con piastrina
Fixed Knob Ø 45 on rose with fixing base

	LV BG	OC OSC	
B52 PF R50	•	•	4
B52 PF 002	•	•	4
B52 PF 60R	•	•	4



art. 52 SICUR

Brass Class 100% Ottone POMOLI GIREVOLI/DOOR KNOBSETS

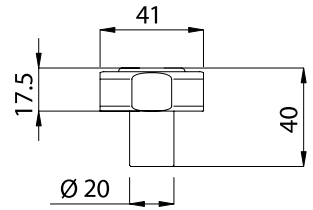

B52 PR 003 - LV



B52 PR 006 - OSC

VERSIONI / VERSIONS



Finiture
Finishes

LV
BG

OC
OSC



SU ROSETTA / ON ROSE



B52 PR 003 Coppia Pomolo Ø45 con rosetta 003
Pair Knob Ø45 on rose

mm Ø45x7

con grano
with grub screw

•

•

2



B52 PR 006 Coppia Pomolo Ø45 con rosetta 006
Pair Knob Ø45 on rose

mm Ø50x8

tipo lusso con grano
lusso type with grub screw

•

•

2

SU PLACCA / ON PLATE

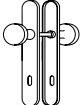

B52 PP 037 Coppia Pomolo Ø45 con placca 037
Pair Knob Ø45 on plate

mm 255x42

con grano
with grub screw

•

•

1

- Specificare se foro chiave normale o yale
Please specify hole for key: yale (europrofile cylinder) or patent/normal

art. 54 BLIND

Brass Class
100% Ottone

POMOLI FISSI/FIXED KNOBS

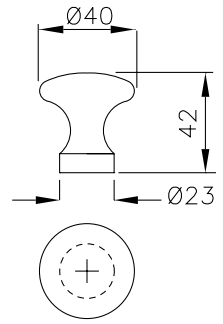

A54 PF R50 - LV



A54 PF 002 - OC



A54 PF 628 - OSC



A54 PF R50 - BG

VERSIONI / VERSIONS



Finiture
Finishes

				LV BG	OC OSC	
POMOLO SU ROSETTA CON FISSAGGIO A PIASTRINA / KNOB ON ROSE WITH FIXING BASE						
	A54 PF R50 Pomolo Fisso Ø 40 con rosetta R50 mm Ø50x9 con piastrina with fixing base			•	•	4
	A54 PF 002 Pomolo Fisso Ø 40 con rosetta 002 mm Ø45x10 con piastrina with fixing base			•	•	4
POMOLO SU ROSETTA CON FISSAGGIO VITI A VISTA / KNOB ON ROSE WITH SCREW FIXING						
	A54 PF 628 Pomolo Fisso con rosetta 628 mm Ø60x11 fissa con 3 fori viti with 3 holes for screws			•	•	4

art. 54 BLIND

Brass Class 100% Ottone **POMOLI GIREVOLI/DOOR KNOBSETS**

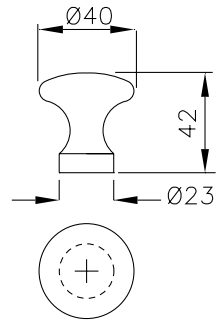

A54 PR 003 - LV



A54 PR 006 - OSC

VERSIONI / VERSIONS



Finiture
Finishes

SU ROSETTA / ON ROSE

	LV	BG	OC	OSC	
A54 PR 003 Coppia Pomolo Ø40 con rosetta 003 mm Ø45x7 con grano with grub screw	•		•		2
A54 PR 006 Coppia Pomolo Ø40 con rosetta 006 mm Ø50x8 tipo lusso con grano lusso type with grub screw	•		•		2

SU PLACCA / ON PLATE

A54 PP 037 Coppia Pomolo Ø40 con placca 037 mm 255x42 con grano with grub screw	•		•		1
---	---	--	---	--	---

- Specificare se foro chiave normale o yale
Please specify hole for key: yale (europrofile cylinder) or patent/normal

A RICHIESTA / ON REQUEST:

- MEZZA COPPIA POMOLO CON ROSETTA O CON PLACCA / HALF PAIR KNOB ON ROSE OR PLATE
- COPPIA POMOLO CON ROSETTA SENZA BOCCHETTA / PAIR KNOB ON ROSE WITHOUT ROSE FOR KEY



art. 55 APOLLO

Brass Class 100% Ottone POMOLI FISSI/FIXED KNOBS



55 PF R50 - LV



destra / right

55 PF 037 - BG

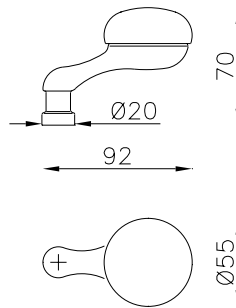

destra / right

55 PF 049 - LV



55 PF R37 - BG



55 PF 009 - LV



55 PF C07 - OSC

VERSIONI / VERSIONS



Finishes

POMOLO SU ROSETTA CON FISSAGGIO A PIATRINA / KNOB ON ROSE WITH FIXING BASE

Model	Description	Size	Material	Shape	Fixing Base
55 PF R50	Pomolo Fisso con rosetta Fixed Knob on rose	R50	mm Ø50x9	con piastrina with fixing base	
55 PF R37	Pomolo Fisso con rosetta Fixed Knob on rose	R37	mm Ø74x41	con piastrina with fixing base	
55 PF 009	Pomolo Fisso con rosetta Fixed Knob on rose	009	mm Ø62x32	ovale con piastrina oval with fixing base	
55 PF C07	Pomolo Fisso con rosetta Fixed Knob on rose	C07	mm 67x27	ovale stretta con piastrina oval and reduced with fixing base	

POMOLO SU PLACCA / KNOB ON PLATE

Model	Description	Size	Material	Finish	Quantity
55 PF 037*	Pomolo Fisso con placca Fixed Knob on plate	037	mm 255x42	yale yale	2
55 PF 049*	Pomolo Fisso con placca Fixed Knob on plate	049	mm 265x55	yale yale	2

* Specificare se richiesto destro o sinistro
Please specify right or left

art. 55 APOLLO

Brass Class 100% Ottone POMOLI GIREVOLI/DOOR KNOBSETS

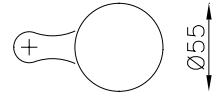
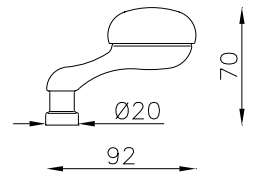

55 PR 006 - LV

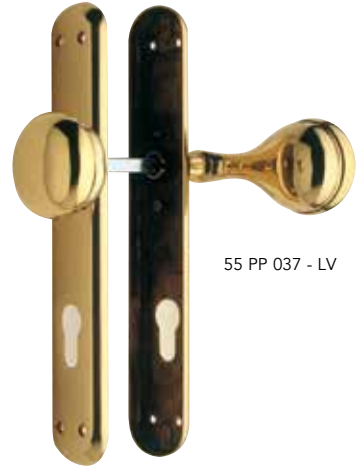

55 PP 037 - LV



55 PR 416 - LV



55 PR 009 - LV

VERSIONI / VERSIONS



Finiture
Finishes

SU ROSETTA / ON ROSE

				LV BG	OSC	AN	AGV	
55 PR 004	Coppia Pomolo con rosetta Pair Knob on rose	004 mm Ø45x9	con molla e grano with spring and grub screw	•	•	•		1
55 PR 006	Coppia Pomolo con rosetta Pair Knob on rose	006 mm Ø50x8	tipo lusso con molla e grano lusso type with spring and grub screw	•	•	•	•	1
55 PR 009	Coppia Pomolo con rosetta Pair Knob on rose	009 mm 62x32	con molla e grano with spring and grub screw	•	•	•		1
55 PR R37	Coppia Pomolo con rosetta Pair Knob on rose	R37 mm 74x41	con molla e grano with spring and grub screw	•				1
55 PR 416	Coppia Pomolo con rosetta Pair Knob on rose	416 mm Ø45x9	con grano with grub screw	•	•			1

SU PLACCA / ON PLATE

55 PP 037	Coppia Pomolo con placca Pair Knob on plate	037 mm 255x42	con molla e grano with spring and grub screw	•	•	•		1
-----------	--	---------------	---	---	---	---	--	---

- Specificare se foro chiave normale o yale
Please specify hole for key: yale (europrofile cylinder) or patent/normal

art. 56 COSMO

Brass Class 100% Ottone POMOLI FISSI/FIXED KNOBS



H56 PF R50 - LV

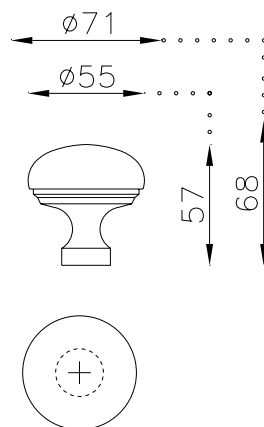

E56 PF 049 - LV



E56 PF 037 - LV



E56 PF 002 - PVD



E56 PF R50 - OC



						LV BG	OC OSC	AN	AGV	NC	PVD	
POMOLO SU ROSETTA CON FISSAGGIO A PIASTRINA / KNOB ON ROSE WITH FIXING BASE												
	E56 PF 002 Pomolo Fisso Ø 60 con rosetta Fixed Knob Ø 60 on rose	002	mm Ø45x10	con piastrina with fixing base		•	•				•	4
	E56 PF R50 Pomolo Fisso Ø 60 con rosetta Fixed Knob Ø 60 on rose	R50	mm Ø50x9	con piastrina with fixing base		•	•	•		•		4
	E56 PF 60R Pomolo Fisso Ø 60 con rosetta Fixed Knob Ø 60 on rose	60R	mm Ø60x9	con piastrina with fixing base		•	•				•	4
	E56 PF R56 Pomolo Fisso Ø 60 con rosetta Fixed Knob Ø 60 on rose	R56	mm Ø70x7	con piastrina with fixing base		•	•			•		4
	H56 PF 002 Pomolo Fisso Ø 75 con rosetta Fixed Knob Ø 75 on rose	002	mm 45x10	con piastrina with fixing base		•	•				•	2
	H56 PF R50 Pomolo Fisso Ø 75 con rosetta Fixed Knob Ø 75 on rose	R50	mm Ø50x9	con piastrina with fixing base		•	•2	•		•		2
	H56 PF R50/ B3 Pomolo Fisso Ø 75 con rosetta Fixed Knob Ø 75 on rose	R50	mm Ø50x9	con piastrina with fixing base		•	•					2
	H56 PF 60R Pomolo Fisso Ø 75 con rosetta Fixed Knob Ø 75 on rose	60R	mm Ø60x9	con piastrina with fixing base		•	•				•	2
	H56 PF R56 Pomolo Fisso Ø 75 con rosetta Fixed Knob Ø 75 on rose	R56	mm Ø70x7	con piastrina with fixing base		•	•			•		2
POMOLO SU ROSETTA CON FISSAGGIO A TRONCONE FILETTATO / KNOB ON ROSE WITH THREADED SCREW FIXING												
	E56 PO 73R Pomolo Ø 60 con rosetta Knob Ø 60 on rose	73R	mm Ø72x9	con troncone filettato with threaded screw		•		•	•			4
	E56 PO R56 Pomolo Ø 60 con rosetta Knob Ø 60 on rose	R56	mm Ø70x7	con troncone filettato with threaded screw		•	•					4
	H56 PO 73R Pomolo Ø 75 con rosetta Fixed Ø 75 on rose	73R	mm Ø72x9	con troncone filettato with threaded screw		•		•	•			2
	H56 PO R56 Pomolo Ø 75 con rosetta Fixed Ø 75 on rose	R56	mm Ø70x7	con troncone filettato with threaded screw		•	•			•		2
POMOLO SU ROSETTA CON FISSAGGIO VITI A VISTA / KNOB ON ROSE WITH SCREW FIXING												
	E56 PF F56 Pomolo Ø 60 con rosetta Knob Ø 60 on rose	F56	mm Ø70x7	fissa con 3 fori viti with 3 holes for screws		•	•					4
	E56 PF 628 Pomolo Ø 60 con rosetta Knob Ø 60 on rose	628	mm Ø60x11	fissa con 3 fori viti with 3 holes for screws		•	•					4
POMOLO SU PLACCA / KNOB ON PLATE												
	E56 PF 037 Pomolo Fisso Ø 60 con placca Fixed Knob Ø 60 on plate	037	mm 255x42	yale yale		•	•	•				4
	E56 PF 188 Pomolo Fisso Ø 60 con placca Fixed Knob Ø 60 on plate	188	mm 255x42	yale yale		•	•				•	4
	E56 PF 049 Pomolo Fisso Ø 60 con placca Fixed Knob Ø 60 on plate	049	mm 265x55	yale yale		•	•				•	2



H56 PF R50/B3 - LV

H56 PF R56 - BG
H56 PO R56 - BG

art. 56 COSMO

Brass Class POMOLI GIREVOLI/DOOR KNOBSETS
100% Ottone



E56 PR 006 - LV



E56 PP 037 - LV



E56 PR 006 - OSC

VERSIONI / VERSIONS



Finiture
Finishes

SU ROSETTA / ON ROSE

					LV BG	OC OSC	AN	AGV	NC	PVD	
	E56 PR 003 Coppia Pomolo Ø60 con rosetta Pair Knob Ø60 on rose	003 mm Ø45x7	con grano with grub screw		•	•	•	•			2
	E56 PR 006 Coppia Pomolo Ø60 con rosetta Pair Knob Ø60 on rose	006 mm Ø50x8	tipo lusso con grano lusso type with grub screw		•	•	•	•	•	•	2
	E56 PR R37 Coppia Pomolo Ø60 con rosetta Pair Knob Ø60 on rose	R37 mm74X41	con grano with grub screw		•						2
	E56 PR 202 Coppia Pomolo Ø60 con rosetta Pair Knob Ø60 on rose	202 mm Ø52x9	con bordo con grano with edge with grub screw		•		•	•	•		2
	E56 PR 406 Coppia Pomolo Ø60 con rosetta Pair Knob Ø60 on rose	406 mm Ø45x9	con grano with grub screw		•	•				•	2

SU PLACCA / ON PLATE

	E56 PP 037 Coppia Pomolo Ø60 con placca Pair Knob Ø60 on plate	037 mm 255x42	con grano with grub screw		•	•					1
	E56 PP 049 Coppia Pomolo Ø60 con placca Pair Knob Ø60 on plate	049 mm 265x55	con grano with grub screw		•	•				•	1

- Specificare se foro chiave normale o yale
Please specify hole for key: yale (europrofile cylinder) or patent/normal

A RICHIESTA / ON REQUEST:

- MEZZA COPPIA POMOLO CON ROSETTA O CON PLACCA / HALF PAIR KNOB ON ROSE OR PLATE
- COPPIA POMOLO CON ROSETTA SENZA BOCCHETTA / PAIR KNOB ON ROSE WITHOUT ROSE FOR KEY



art. 57 MARGHERITA

Brass Class
100% Ottone

POMOLI FISSI/FIXED KNOBS

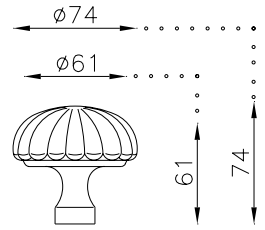

H57 PF 73R - LV
H57 PO 73R - LV

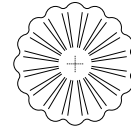

E57 PF 006 - AN



E57 PF 006 - AGV



H57 PF 73R - AN
H57 PO 73R - AN



H57 PF 73R - BF
H57 PO 73R - BF



H57 PF R50 - BG



H57 PF 73R - AGV
H57 PO 73R - AGV

VERSIONI / VERSIONS



Finiture
Finishes

POMOLO SU ROSETTA CON FISSAGGIO A PIASTRINA / KNOB ON ROSE WITH FIXING BASE

					LV BG	AN	AGV	BF	
E57 PF R50	Pomolo Fisso Ø 60 con rosetta R50 Fixed Knob Ø 60 on rose	mm Ø50x9	con piastrina with fixing base		•	•			4
E57 PF 73R	Pomolo Fisso Ø 60 con rosetta 73R Fixed Knob Ø 60 on rose	mm Ø72x9	con piastrina with fixing base		•	•	•	•	4
E57 PF 006	Pomolo Fisso Ø 60 con rosetta 006 Fixed Knob Ø 60 on rose	mm Ø50x9	tipo lusso con piastrina lusso type with fixing base		•	•	•		4
H57 PF R50	Pomolo Fisso Ø 75 con rosetta R50 Fixed Knob Ø 75 on rose	mm Ø50x9	con piastrina with fixing base		•	•			2
H57 PF 73R	Pomolo Fisso Ø 75 con rosetta 73R Fixed Knob Ø 75 on rose	mm Ø72x9	con piastrina with fixing base		•	•	•	•	2
H57 PF 006	Pomolo Fisso Ø 75 con rosetta 006 Fixed Knob Ø 75 on rose	mm Ø50x9	tipo lusso con piastrina lusso type with fixing base		•	•	•		2

POMOLO SU ROSETTA CON FISSAGGIO A TRONCONE FILETTATO / KNOB ON ROSE WITH THREADED SCREW FIXING

E57 PO 73R	Pomolo Ø 60 con rosetta Knob Ø 60 on rose	73R	mm Ø72x9	con troncone filettato with threaded screw	•	•	•	•	4
H57 PO 73R	Pomolo Ø 75 con rosetta Knob Ø 75 on rose	73R	mm Ø72x9	con troncone filettato with threaded screw	•	•	•	•	2

art. 57 MARGHERITA

Brass Class POMOLI GIREVOLI/DOOR KNOBSETS
100% Ottone



E57 PR 202 - LV



E57 PP 039 - LV





E57 PR 006 - BG

VERSIONI / VERSIONS



Finiture
Finishes

SU ROSETTA / ON ROSE

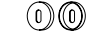
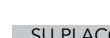
					LV BG	AN	AGV	BF	
	E57 PR 003 Coppia Pomolo Ø 60 con rosetta Pair Knob Ø 60 on rose	003	mm Ø45x7	con grano with grub screw	•	•	•	•	2
	E57 PR 006 Coppia Pomolo Ø 60 con rosetta Pair Knob Ø 60 on rose	006	mm Ø50x8	tipo lusso con grano lusso type with grub screw	•	•	•2		2
	E57 PR 202 Coppia Pomolo Ø 60 con rosetta Pair Knob Ø 60 on rose	202	mm Ø52x9	con bordo con grano with edge with grub screw	•	•	•		2

SU PLACCA / ON PLATE

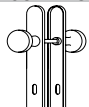
	E57 PP 039 Coppia Pomolo Ø60 con placca Pair Knob Ø60 on plate	039	mm 255x50	con grano with grub screw	•	•	•		1
--	---	-----	-----------	------------------------------	---	---	---	--	---

- Specificare se foro chiave normale o yale
Please specify hole for key: yale (europrofile cylinder) or patent/normal

art. 59 SFERA

Brass Class 100% Ottone **POMOLI GIREVOLI/DOOR KNOBSETS**



E59 PR 006 - LV



C59 PR 406 - OSC

VERSIONI / VERSIONS



Finiture
Finishes

SU ROSETTA / ON ROSE

				LV BG	OC OSC	PVD	
C59 PR 003	Coppia Pomolo Ø 50 con rosetta Pair Knob Ø 50 on rose	003 mm Ø45x7	con grano with grub screw	•	•		2
C59 PR 006	Coppia Pomolo Ø 50 con rosetta Pair Knob Ø 50 on rose	006 mm Ø50x8	tipo lusso con grano lusso type with grub screw	•	•		2
C59 PR 406	Coppia Pomolo Ø 50 con rosetta Pair Knob Ø 50 on rose	406 mm Ø45x9	con grano with grub screw	•	•		2
E59 PR 003	Coppia Pomolo Ø 60 con rosetta Pair Knob Ø 60 on rose	003 mm Ø45x7	con grano with grub screw	•	•		2
E59 PR 006	Coppia Pomolo Ø 60 con rosetta Pair Knob Ø 60 on rose	006 mm Ø50x8	tipo lusso con grano lusso type with grub screw	•	•	•	2
E59 PR 406	Coppia Pomolo Ø 60 con rosetta Pair Knob Ø 60 on rose	406 mm Ø45x9	con grano with grub screw	•	•	•	2

- Specificare se foro chiave normale o yale
Please specify hole for key: yale (europrofile cylinder) or patent/normal

art. **59** SFERA

Brass Class 100% Ottone **POMOLI FISSI/FIXED KNOBS**

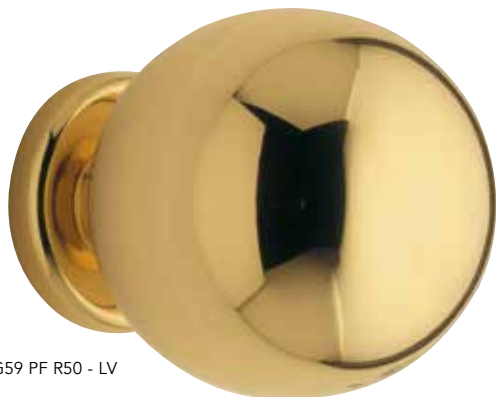
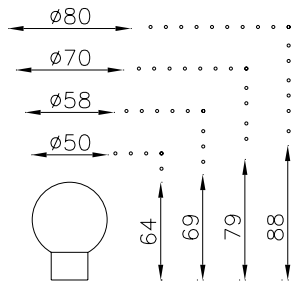

G59 PF R50 - LV



E59 PF 002 - PVD



C59 PF 049 - LV



C59 PF 188 - LV



E59 PF R50 - OC



E59 PF R56 - OSC
E59 PO R56 - OSC



C59 PF F56 - BG



					LV BG	OC OSC	PVD	
POMOLO SU ROSETTA CON FISSAGGIO A PIASTRINA / KNOB ON ROSE WITH FIXING BASE								
	C59 PF 002 Pomolo Fisso Ø 50 con rosetta Fixed Knob Ø 50 on rose	002	mm Ø45x10	con piastrina with fixing base	•	•		4
	C59 PF R50 Pomolo Fisso Ø 50 con rosetta Fixed Knob Ø 50 on rose	R50	mm Ø50x9	con piastrina with fixing base	•	•		4
	E59 PF 002 Pomolo Fisso Ø 60 con rosetta Fixed Knob Ø 60 on rose	002	mm Ø45x10	con piastrina with fixing base	•	•	•	4
	E59 PF R50 Pomolo Fisso Ø 60 con rosetta Fixed Knob Ø 60 on rose	R50	mm Ø50x9	con piastrina with fixing base	•	•		4
	E59 PF 60R Pomolo Fisso Ø 60 con rosetta Fixed Knob Ø 60 on rose	60R	mm Ø60x9	con piastrina with fixing base	•	•	•	4
	E59 PF R56 Pomolo Fisso Ø 60 con rosetta Fixed Knob Ø 60 on rose	R56	mm Ø70x7	con piastrina with fixing base	•	•		4
	G59 PF 002 Pomolo Fisso Ø 70 con rosetta Fixed Knob Ø 70 on rose	002	mm Ø45x10	con piastrina with fixing base	•	•	•	2
	G59 PF R50 Pomolo Fisso Ø 70 con rosetta Fixed Knob Ø 70 on rose	R50	mm Ø50x9	con piastrina with fixing base	•	•		2
	G59 PF 60R Pomolo Fisso Ø 70 con rosetta Fixed Knob Ø 70 on rose	60R	mm Ø60x9	con piastrina with fixing base	•	•	•	2
	G59 PF R56 Pomolo Fisso Ø 70 con rosetta Fixed Knob Ø 70 on rose	R56	mm Ø70x7	con piastrina with fixing base	•	•		2
	L59 PF R50 Pomolo Fisso Ø 80 con rosetta Fixed Knob Ø 80 on rose	R50	mm Ø50x9	con piastrina with fixing base	•	•		2
	L59 PF R56 Pomolo Fisso Ø 80 con rosetta Fixed Knob Ø 80 on rose	R56	mm Ø70x7	con piastrina with fixing base	•	•		2
POMOLO SU ROSETTA CON FISSAGGIO A TRONCONE FILETTATO / KNOB ON ROSE WITH THREADED SCREW FIXING								
	C59 PO R50 Pomolo Ø 50 con rosetta Knob Ø 50 on rose	R50	mm Ø50x9	con troncone filettato with threaded screw	•	•		4
	E59 PO R56 Pomolo Ø 60 con rosetta Knob Ø 60 on rose	R56	mm Ø70x7	con troncone filettato with threaded screw	•	•		4
	G59 PO R56 Pomolo Ø 70 con rosetta Knob Ø 70 on rose	R56	mm Ø70x7	con troncone filettato with threaded screw	•	•		2
	L59 PO R56 Pomolo Ø 80 con rosetta Knob Ø 80 on rose	R56	mm Ø70x7	con troncone filettato with threaded screw	•	•		2
POMOLO SU ROSETTA CON FISSAGGIO VITI A VISTA / KNOB ON ROSE WITH SCREW FIXING								
	C59 PF F56 Pomolo Ø 50 con rosetta Knob Ø 50 on rose	F56	mm Ø70x7	fissa con 3 fori viti with 3 holes for screws	•	•		4
	C59 PF 628 Pomolo Ø 50 con rosetta Knob Ø 50 on rose	628	mm Ø60x11	fissa con 3 fori viti with 3 holes for screws	•	•		4
POMOLO SU PLACCA / KNOB ON PLATE								
	C59 PF 037 Pomolo Fisso Ø 50 con placca Fixed Knob Ø 50 on plate	037	mm 255x42	yale yale	•	•		4
	C59 PF 188 Pomolo Fisso Ø 50 con placca Fixed Knob Ø 50 on plate	188	mm 255x42	yale yale	•	•		4
	C59 PF 049 Pomolo Fisso Ø 50 con placca Fixed Knob Ø 50 on plate	049	mm 265x55	yale yale	•	•		2
	E59 PF 037 Pomolo Fisso Ø 60 con placca Fixed Knob Ø 60 on plate	037	mm 255x42	yale yale	•	•		2
	E59 PF 188 Pomolo Fisso Ø 60 con placca Fixed Knob Ø 60 on plate	188	mm 255x42	yale yale	•	•	•	2
	E59 PF 049 Pomolo Fisso Ø 60 con placca Fixed Knob Ø 60 on plate	049	mm 265x55	yale yale	•	•	•	2

art. 60 OTTAGONALE

Brass Class
100% Ottone

POMOLI FISSI/FIXED KNOBS

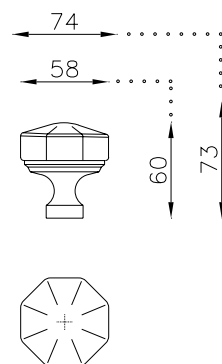

H60 PF 73R - LV
H60 PO 73R - LV



H60 PF 73R AN
H60 PO 73R AN



E60 PF R50 BG

VERSIONI / VERSIONS



Finiture
Finishes

POMOLO SU ROSETTA CON FISSAGGIO A PIASTRINA / KNOB ON ROSE WITH FIXING BASE

					LV BG	AN		
	E60 PF R50	Pomolo Fisso Ø 60 con rosetta Fixed Knob Ø 60 on rose	R50	mm Ø50x9	con piastrina with fixing base	•	•	4
	E60 PF 73R	Pomolo Fisso Ø 60 con rosetta Fixed Knob Ø 60 on rose	73R	mm Ø72x9	con piastrina with fixing base	•	•	4
	H60 PF R50	Pomolo Fisso Ø 75 con rosetta Fixed Knob Ø 75 on rose	R50	mm Ø50x9	con piastrina with fixing base	•	•	2
	H60 PF 73R	Pomolo Fisso Ø 75 con rosetta Fixed Knob Ø 75 on rose	73R	mm Ø72x9	con piastrina with fixing base	•	•	2

POMOLO SU ROSETTA CON FISSAGGIO A TRONCONE FILETTATO / KNOB ON ROSE WITH THREADED SCREW FIXING

	E60 PO 73R	Pomolo Ø 60 con rosetta Knob Ø 60 on rose	73R	mm Ø72x9	con troncone filettato with threaded screw	•	•	4
	H60 PO 73R	Pomolo Ø 75 con rosetta Fixed Ø 75 on rose	73R	mm Ø72x9	con troncone filettato with threaded screw	•	•	2

art. 60 OTTAGONALE

Brass Class
100% Ottone

POMOLI GIREVOLI/DOOR KNOBSETS



E60 PR 006 - LV



E60 PP 039 - LV





E60 PR 202 - AN

VERSIONI / VERSIONS

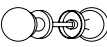

Finiture
Finishes

SU ROSETTA / ON ROSE

					LV BG	AN	
	E60 PR 003 Coppia Pomolo Ø60 con rosetta 003 Pair Knob Ø60 on rose	mm Ø45x7	con grano with grub screw		•	•	2
	E60 PR 006 Coppia Pomolo Ø60 con rosetta 006 Pair Knob Ø60 on rose	mm Ø50x8	tipo lusso con grano lusso type with grub screw		•	•	2
	E60 PR 202 Coppia Pomolo Ø60 con rosetta 202 Pair Knob Ø60 on rose	mm Ø52x9	con bordo con grano with edge with grub screw		•	•	2
	E60 PR 406 Coppia Pomolo Ø60 con rosetta 406 Pair Knob Ø60 on rose	mm Ø45x9	con grano with grub screw		•	•	2

SU PLACCA / ON PLATE

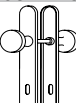
	E60 PP 039 Coppia Pomolo Ø60 con placca 039 Pair Knob Ø60 on plate	mm 255x50	con grano with grub screw		•	•	1
--	---	-----------	------------------------------	--	---	---	---

- Specificare se foro chiave normale o yale
Please specify hole for key: yale (europrofile cylinder) or patent/normal

art. **61** **ULISSE**

Brass Class 100% Ottone **POMOLI FISSI/FIXED KNOBS**

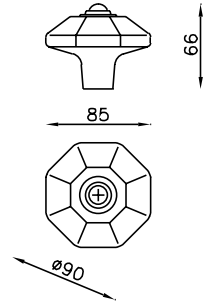

N61 PF 73R - LV
N61 PO 73R - LV



N61 PF 73R - AN
N61 PO 73R - AN



N61 PF 73R - BG
N61 PO 73R - BG



N61 PF 100 - VBN
N61 PO 100 - VBN

VERSIONI / VERSIONS



Finiture
Finishes

POMOLO SU ROSETTA CON FISSAGGIO A PIASTRINA / KNOB ON ROSE WITH FIXING BASE

N61 PF 73R Pomolo Fisso Ø 90 con rosetta 73R mm Ø72x9 con piastrina
Fixed Knob Ø 90 on rose with fixing base

N61 PF 100 Pomolo Fisso Ø 90 con rosetta 100 mm Ø100x10 con piastrina
Fixed Knob Ø 90 on rose with fixing base

POMOLO SU ROSETTA CON FISSAGGIO A TRONCONE FILETTATO / KNOB ON ROSE WITH THREADED SCREW FIXING

N61 P 73R Pomolo Ø 90 con rosetta 73R mm Ø72x9 con troncone filettato
Knob Ø 90 on rose with threaded screw

N61 PO 100 Pomolo Fisso Ø 90 con rosetta 100 mm Ø100x10 con troncone filettato
Fixed Knob Ø 90 on rose with threaded screw

	LV BG	AN	VBN	
N61 PF 73R	•	•	•	1
N61 PF 100	•	•	•	1
N61 P 73R	•	•	•	1
N61 PO 100	•	•	•	1

art. **71** UNICO

design: Marco Pialorsi
materiale: Ottone
material: Solid Brass

POMOLI FISSI/FIXED KNOBS

Brass Class
100% Ottone

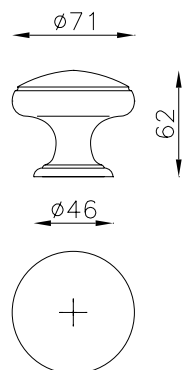

G71 PF - LV



G71 PF - OSC/OC



G71 PO/637 - LV



G71 PF - OSC



G71 PF - BG

art. 71 UNICO

Brass Class
100% Ottone

POMOLI FISSI/FIXED KNOBS



esempi di pomolo G71
su rosetta R71
example to apply Knob
G71 on rose R71



R71 RO - LV



R71 RO - PVD INOX

VERSIONI / VERSIONS



Finiture
Finishes

POMOLO CON BASE Ø46 CON FISSAGGIO A PIASTRINA / FIXED KNOB WITH FIXING BASE



G71 PF	Pomolo Fisso Ø 70 con base Fixed Knob Ø 70 with base	mm Ø46	con piastrina with fixing base	LV BG OS	OSC OC BGO	OS/ LV	OSC/OC	PVD	PVD INOX	LR VBN	
				•	•	•	•	•	•	•	4

POMOLO CON BASE Ø46 CON FISSAGGIO A TRONCONE FILETTATO / FIXED KNOB WITH THREADED SCREW FIXING



G71 PO	Pomolo Fisso Ø 70 con base Fixed Knob Ø 70 with base	mm Ø46	con troncone filettato with threaded screw	LV BG OS	OSC OC BGO	OS/ LV	OSC/OC	PVD	PVD INOX	LR VBN	
				•	•	•	•	•	•	•	4
G71 PO/637	Pomolo Fisso Ø 70 con base Fixed Knob Ø 70 with base	mm Ø46	con troncone e copricado 637 with threaded pin and nut	•	•	•	•	•	•	•	4

A RICHIESTA / ON REQUEST: Extra per sistema antisvitamento
Extra for lock system € 0,74

ROSETTA OPZIONALE Ø 70 / OPTIONAL ROSE Ø 70

R71 RO	Rosetta aggiuntiva per l'allargamento del diametro di base a mm 70 Rose adapter for improving diameter on base to	mm Ø70		LV BG OS	OSC OC BGO	OS/ LV	OSC/OC	PVD	PVD INOX	LR VBN	
				•	•			•	•	•	

POMOLI FISSI/FIXED KNOBS

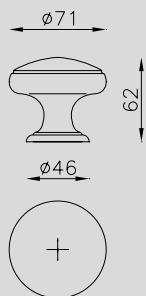

G71 PV - LV



VERSIONI / VERSIONS



Finiture
Finishes

POMOLI CON BASE Ø46 / FIXED KNOB

G71 PV

Coppia Pomolo fisso Ø70 per vetro
Fixed Pair Knob Ø70 for glass doors

	LV OS	BG OS	OSC OC BGO	OS/LV	OSC/OC	PVD	PVD INOX	LR VBN	
G71 PV	•	•	•	•	•	•	•	•	1



art. 75 TRIANGOLO

Brass Class 100% Ottone POMOLI FISSI/FIXED KNOBS

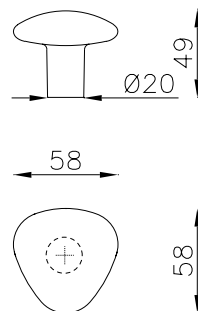

75 PF R50 - LV



75 PF R50 - OC



75 PF 002 - OSC



75 PF 248 - LV

VERSIONI / VERSIONS



Finire
Finishes

				LV	BG	OC	
				OS		OSC	
POMOLO SU ROSETTA CON FISSAGGIO A PIASTRINA / KNOB ON ROSE WITH FIXING BASE							
	75 PF R50	Pomolo Fisso con rosetta Fixed Knob on rose	R50 mm Ø50x9	con piastrina with fixing base	•	•	4
	75 PF 002	Pomolo Fisso con rosetta Fixed Knob on rose	002 mm 45x10	con piastrina with fixing base	•	•	4
	75 PF 248	Pomolo Fisso con placca Fixed Knob on plate	248 mm 248x50	yale yale	•	•	2

art. 75 TRIANGOLO

Brass Class POMOLI GIREVOLI/DOOR KNOBSETS
100% Ottone



75 PR 003 - LV



75 PP 248 - LV



75 PR 006 - OSC

VERSIONI / VERSIONS



Finiture
Finishes

SU ROSETTA / ON ROSE

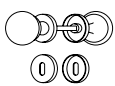

75 PR 003	Coppia Pomolo con rosetta Pair Knob on rose	003	mm Ø45x7	con grano with grub screw			•	•	2
75 PR 006	Coppia Pomolo con rosetta Pair Knob on rose	006	mm Ø50x8	tipo lusso con grano lusso type with grub screw			•	•	2

SU PLACCA / ON PLATE

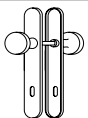

75 PP 037	Coppia Pomolo con placca Pair Knob on plate	037	mm 255x42	con grano with grub screw			•	•	1
75 PP 248	Coppia Pomolo con placca Pair Knob on plate	248	mm 248x50	con grano with grub screw			•2	•	1

- Specificare se foro chiave normale o yale
Please specify hole for key: yale (europrofile cylinder) or patent/normal

art. 97 UOVO

Brass Class 100% Ottone POMOLI FISSI/FIXED KNOBS

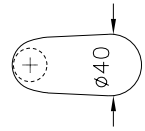
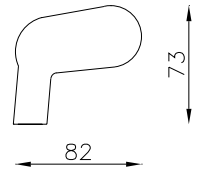

97 PF 009 - LV



97 PF C07 - OC

destro / right



97 PF 009 - OSC



97 PF 066 - LV



97 PF R50 - BG



97 PF 009 - NR

VERSIONI / VERSIONS



Finiture
Finishes

POMOLO SU ROSETTA CON FISSAGGIO A PIASTRINA / KNOB ON ROSE WITH FIXING BASE

			LV OS	BG	OC OSC	NR	
97 PF R50	Pomolo Fisso con rosetta Fixed Knob on rose	R50 mm Ø50x9	con piastrina with fixing base	•	•		2
97 PF 009	Pomolo Fisso con rosetta Fixed Knob on rose	009 mm 62x32	ovale con piastrina oval with fixing base	•	•	•	2
97 PF C07	Pomolo Fisso con rosetta Fixed Knob on rose	C07 mm 67x27	ovale stretta con piastrina oval and reduced with fixing base	•	•		2

POMOLO SU PLACCA / KNOB ON PLATE

97 PF 066*	Pomolo Fisso con placca Fixed Knob on plate	066 mm 240x37	yale yale	•	•		2
------------	--	---------------	--------------	---	---	--	---

* Specificare se richiesto destro o sinistro
Please specify right or left

art. 98 CLASSIC

Brass Class 100% Ottone POMOLI GIREVOLI/DOOR KNOBSETS

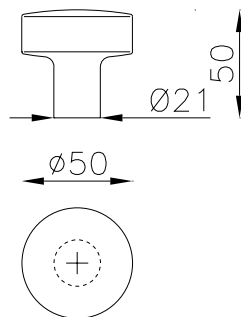

C98 PR 406 - OSC

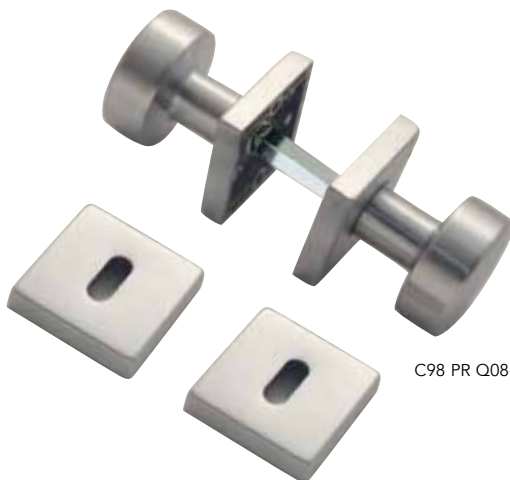

C98 PR Q08 - OSC

VERSIONI / VERSIONS



Finiture
Finishes

SU ROSETTA / ON ROSE

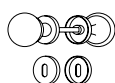

C98 PR 406 Coppia Pomolo Ø50 con rosetta 406 mm Ø45x9 con grano
Pair Knob Ø50 on rose with grub screw

C98 PR Q08 Coppia Pomolo Ø50 con rosetta Q08 mm 50x50 con grano
Pair Knob Ø50 on rose with grub screw

LV

OC
OSC



•

•

2

•

•

1

- Specificare se foro chiave normale o yale
Please specify hole for key: yale (europrofile cylinder) or patent/normal

A RICHIESTA / ON REQUEST:

- Mezza coppia pomolo con rosetta o con placca / Half pair knob on rose or plate
- Coppia pomolo con rosetta senza bocchetta / Pair knob on rose without rose for key



art. **98** CLASSIC

Brass Class 100% Ottone POMOLI FISSI/FIXED KNOBS

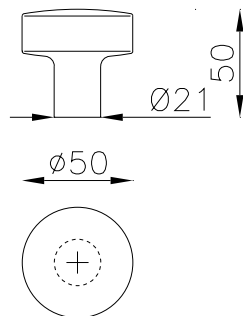

C98 PF R50 - LV



C98 PF 037 - LV



C98 PF 130 - OSC

VERSIONI / VERSIONS



					LV	OC OSC	
POMOLO SU ROSETTA CON FISSAGGIO A PIASTRINA / KNOB ON ROSE WITH FIXING BASE							
	C98 PF R50	Pomolo Fisso con rosetta Fixed Knob on rose	R50 mm Ø50x9	con piastrina with fixing base	•	•2	4
	C98 PF 002	Pomolo Fisso con rosetta Fixed Knob on rose	002 mm 45x10	con piastrina with fixing base	•	•	4
	C98 PF C07	Pomolo Fisso con rosetta Fixed Knob on rose	C07 mm 67x27	ovale stretta con piastrina oval and reduced with fixing base	•	•	4
	C98 PF 60R	Pomolo Fisso con rosetta Fixed Knob on rose	60R mm Ø60x9	con piastrina with fixing base	•	•	4
	C98 PF Q08	Pomolo Fisso con rosetta Fixed Knob on rose	Q08 mm 50x50	con piastrina with fixing base	•	•	4
POMOLO SU ROSETTA CON FISSAGGIO VITI A VISTA / KNOB ON ROSE WITH SCREW FIXING							
	C98 PF F56	Pomolo Fisso con rosetta Fixed Knob on rose	F56 mm Ø70x7	fissa con 3 fori viti with 3 holes for screws	•	•	4
	C98 PF 628	Pomolo Fisso con rosetta Fixed Knob on rose	628 mm Ø60x11	fissa con 3 fori viti with 3 holes for screws	•	•	4
POMOLO SU PLACCA / KNOB ON PLATE							
	C98 PF 037	Pomolo Fisso con placca Fixed Knob con plate	037 mm 255x42	yale yale	•	•	2
	C98 PF 049	Pomolo Fisso con placca Fixed Knob con plate	049 mm 265x55	yale yale	•	•	2
	C98 PF 130	Pomolo Fisso con placca Fixed Knob con plate	130 mm 245x50	yale yale	•	•	2



C98 PF F56 - LV



C98 PF 002 - OSC



C98 PF C07 - OC



C98 PF Q08 - OSC



C98 PF Q08 - OC

art. 124 Q-ARTE

Brass Class 100% Ottone **POMOLI FISSI/FIXED KNOBS**

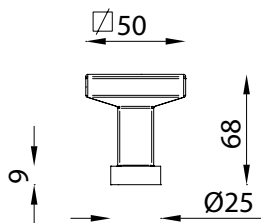

124 PF Q08 - OSC

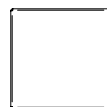

124 PF Q08-OC





124 PF 130 - OC

VERSIONI / VERSIONS

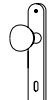

Finiture
Finishes

		OSC	OC	SNV	
POMOLO SU ROSETTA CON FISSAGGIO A PIASTRINA / KNOB ON ROSE WITH FIXING BASE					
	124 PF Q08 Pomolo Fisso con rosetta / Fixed Knob on rose	Q08	mm 50x50	con piastrina / with fixing base	• • z
POMOLO SU PLACCA / KNOB ON PLATE					
	124 PF 130 Pomolo Fisso con placca / Fixed Knob on plate	130	mm 245x50	yale yale	• • 2

art. 124 Q-ARTE

Brass Class 100% Ottone POMOLI GIREVOLI/DOOR KNOBSETS

124 PR Q08 OSC

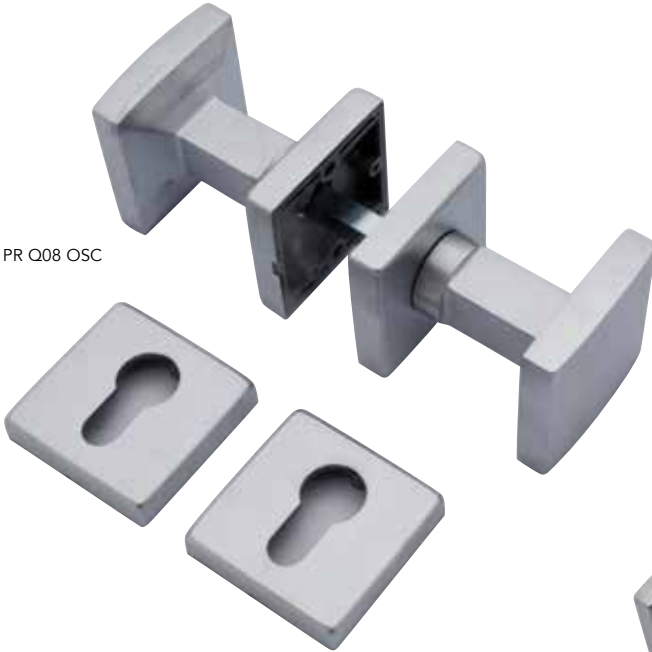

124 PP 130 OSC



124 PR Q08 OC



VERSIONI / VERSIONS





Finiture
Finishes

OC
OSC



SU ROSETTA / ON ROSE

	124 PR Q08	Coppia Pomolo con rosetta Pair Knob on rose	Q08	mm 50x50	con grano with grub screw	•	1
	124 PR Q86	Coppia Pomolo con rosetta Pair Knob on rose	Q86	mm 50x50	con molla e grano with spring and grub screw	•	1

SU PLACCA / ON PLATE

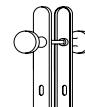
	124 PP 130	Coppia Pomolo con placca Pair Knob on plate	130	mm 245x50	con grano with grub screw	•	1
--	------------	--	-----	-----------	------------------------------	---	---

- Specificare se foro chiave normale o yale
Please specify hole for key: yale (europrofile cylinder) or patent/normal

art. **345** **ARIO**

Brass Class 100% Ottone **POMOLI FISSI/FIXED KNOBS**

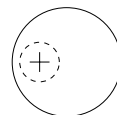
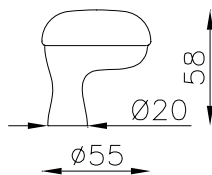

345 PF R50 - LV



destro / right

345 PF 049 - LV



destro / right

345 PF 037 - OSC



345 PF C07 - OC



345 PF 002 - OSC



POMOLO SU ROSETTA CON FISSAGGIO A PIASTRINA / KNOB ON ROSE WITH FIXING BASE

					LV BG	OC OSC	PVD	
345 PF R50	Pomolo Fisso con rosetta Fixed Knob on rose	R50	mm Ø50x9	con piastrina with fixing base	•	•		4
345 PF 002	Pomolo Fisso con rosetta Fixed Knob on rose	002	mm 45x10	con piastrina with fixing base	•	•	•	4
345 PF 009	Pomolo Fisso con rosetta Fixed Knob on rose	009	mm 62x32	ovale con piastrina oval with fixing base	•	•	•	4
345 PF C07	Pomolo Fisso con rosetta Fixed Knob on rose	C07	mm Ø67x27	ovale stretta con piastrina oval and reduced with fixing base	•	•	•	4

POMOLO SU PLACCA / KNOB ON PLATE



345 PF 037*	Pomolo Fisso con placca Offset Fixed Knob on plate	037	mm 255x42	yale yale	•	•		4
345 PF 049*	Pomolo Fisso con placca Offset Fixed Knob on plate	049	mm 265x55	yale yale	•	•	•	2

* Specificare se richiesto destro o sinistro
Please specify right or left



345 PF 009 - BG



345 PF 009 - OSC

art. **346** ATLANTIDE

Brass Class 100% Ottone POMOLI FISSI/FIXED KNOBS

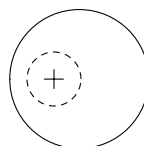
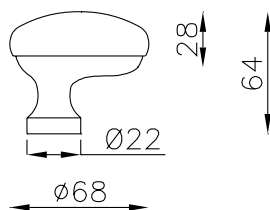

346 PF 006 - LV



346 PF 002 - PVD



destro / right

346 PF 037 - LV



destro / right

346 PF 049 - OC



POMOLO SU ROSETTA CON FISSAGGIO A PIASTRINA / KNOB ON ROSE WITH FIXING BASE

					LV BG	OC OSC	PVD	
346 PF R50	Pomolo Fisso con rosetta Fixed Knob on rose	R50	mm Ø50x9	con piastrina with fixing base	•	•		2
346 PF 002	Pomolo Fisso con rosetta Fixed Knob on rose	002	mm 45x10	con piastrina with fixing base	•	•	•	2
346 PF 006	Pomolo Fisso con rosetta Fixed Knob on rose	006	mm 50x8	tipo lusso con piastrina lusso type with fixing base	•	•	•	2
346 PF C07	Pomolo Fisso con rosetta Fixed Knob on rose	C07	mm 67x27	ovale stretta con piastrina oval and reduced with fixing base	•	•	•	2
346 PF 009	Pomolo Fisso con rosetta Fixed Knob on rose	009	mm 62x32	ovale con piastrina oval with fixing base	•	•	•	2
346 PF 60R	Pomolo Fisso con rosetta Fixed Knob on rose	60R	mm Ø60x9	con piastrina with fixing base	•	•	•	2

POMOLO SU PLACCA / KNOB ON PLATE

346 PF 037*	Pomolo Fisso con placca Offset Fixed Knob on plate	037	mm 255x42	yale yale	•	•		2
346 PF 049*	Pomolo Fisso con placca Offset Fixed Knob on plate	049	mm 265x55	yale yale	•	•	•	2

* Specificare se richiedo destro o sinistro
Please specify right or left



346 PF C07 - OC



346 PF 009 - OSC



346 PF R50 - BG



346 PF 60R - LV

art. 345 ARIO

Brass Class 100% Ottone POMOLI GIREVOLI/DOOR KNOBSETS

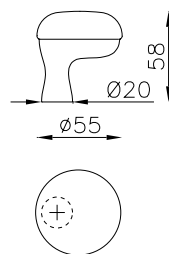

345 PR 406 - LV



345 PR 009 - OC

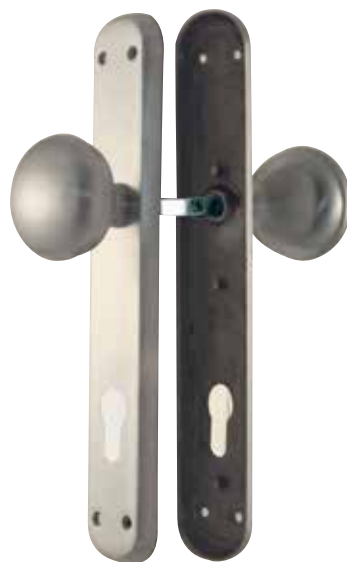

345 PP 037 - OSC

VERSIONI / VERSIONS



Finiture
Finishes

					LV BG	OC OSC	PVD		
SU ROSETTA / ON ROSE									
	345 PR 003	Coppia Pomolo con rosetta Pair Knob on rose	003	mm Ø45x7	con grano with grub screw	•	•	•	2
	345 PR 006	Coppia Pomolo con rosetta Pair Knob on rose	006	mm Ø50x8	tipo lusso con grano lusso type with grub screw	•	•	•	2
	345 PR 007	Coppia Pomolo con rosetta Pair Knob on rose	007	mm 67x27	con grano with grub screw	•	•	•	2
	345 PR 009	Coppia Pomolo con rosetta Pair Knob on rose	009	mm 62x32	con grano with grub screw	•	•	•	2
	345 PR 406	Coppia Pomolo con rosetta Pair Knob on rose	406	mm Ø45x9	con grano with grub screw	•	•	•	2
SU PLACCA / ON PLATE									
	345 PP 037	Coppia Pomolo con placca Pair Knob on plate	037	mm 255x42	con grano with grub screw	•	•	•	1
	345 PP 049	Coppia Pomolo con placca Pair Knob on plate	049	mm 265x55	con grano with grub screw	•	•	•	1

- Specificare se foro chiave normale o yale
Please specify hole for key: yale (europrofile cylinder) or patent/normal

art. 346 ATLANTIDE

Brass Class POMOLI GIREVOLI/DOOR KNOBSETS
100% Ottone

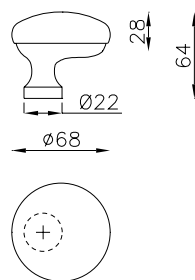

346 PR 006 - LV



346 PR 406 - OSC



346 PP 037 - OSC



VERSIONI / VERSIONS



Finestra
Finishes

						LV BG	OC OSC	PVD	
SU ROSETTA / ON ROSE									
	346 PR 003	Coppia Pomolo con rosetta Pair Knob on rose	003	mm Ø45x7	con grano with grub screw	•	•		2
	346 PR 006	Coppia Pomolo con rosetta Pair Knob on rose	006	mm Ø50x8	tipo lusso con grano lusso type with grub screw	•	•	•	2
	346 PR 007	Coppia Pomolo con rosetta Pair Knob on rose	007	mm 67x27	con grano with grub screw	•	•		2
	346 PR 009	Coppia Pomolo con rosetta Pair Knob on rose	009	mm 62x32	con grano with grub screw	•	•	•	2
	346 PR 406	Coppia Pomolo con rosetta Pair Knob on rose	406	mm Ø45x9	con grano with grub screw	•	•	•	2
SU PLACCA / ON PLATE									
	346 PP 037	Coppia Pomolo con placca Pair Knob on plate	037	mm 255x42	con grano with grub screw	•	•		1
	346 PP 049	Coppia Pomolo con placca Pair Knob on plate	049	mm 265x55	con grano with grub screw	•	•	•	1

- Specificare se foro chiave normale o yale
Please specify hole for key: yale (europrofile cylinder) or patent/normal

art. **347** **CLEO**

design: Marco Pialorsi
materiale: Ottone
material: Solid Brass

Brass Class
100% Ottone

POMOLI FISSI/FIXED KNOBS

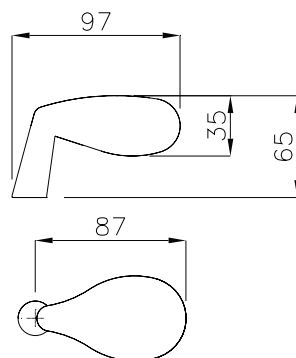

347 PF 002-OSC



destro / right

347 PF 049-LV

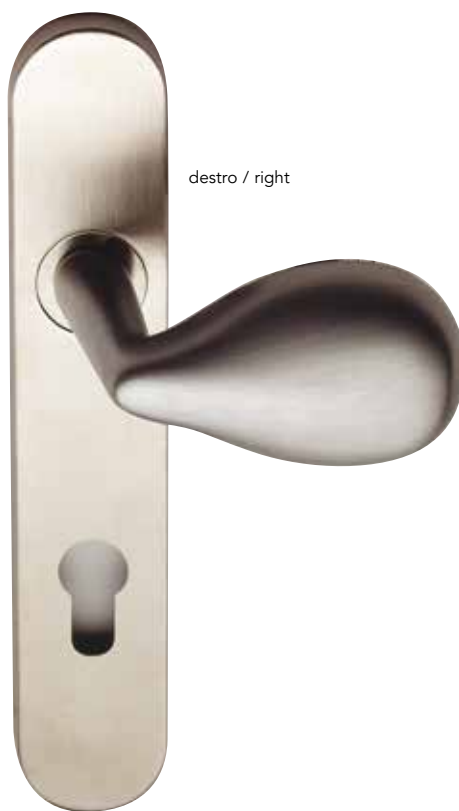

destro / right

347 PF 702-PVD INOX



POMOLO SU ROSETTA CON FISSAGGIO A PIASTRINA / KNOB ON ROSE WITH FIXING BASE

					LV BG	OSC OC	PVD	PVD INOX	
347 PF 002	Pomolo Fisso con rosetta Fixed Knob on rose	002	mm Ø45X9	con piastrina with fixing base	•	•	•	•	2
347 PF 009	Pomolo Fisso con rosetta Fixed Knob on rose	009	mm 62x32	con piastrina with fixing base	•	•	•	•	2
347 PF C07	Pomolo Fisso con rosetta Fixed Knob on rose	C07	mm 67x27	ovale stretta con piastrina oval and reduced with fixing base	•	•	•		2

POMOLO SU PLACCA / KNOB ON PLATE

347 PF 037*	Pomolo Fisso con placca Fixed Knob on plate	037	mm 255x42	yale yale	•	•			2
347 PF 049*	Pomolo Fisso con placca Fixed Knob on plate	049	mm 265x55	yale yale	•	•	•		2
347 PF 702*	Pomolo Fisso con placca Fixed Knob on plate	702	mm 225x42	yale yale				•	2

* Specificare se richiesto destro o sinistro
Please specify right or left



347 PF 037-OSC

destro / right



347 PF 009-BG



347 PF 009-PVD INOX

art. 348 ENTRY

Brass Class
100% Ottone

POMOLI FISSI/FIXED KNOBS

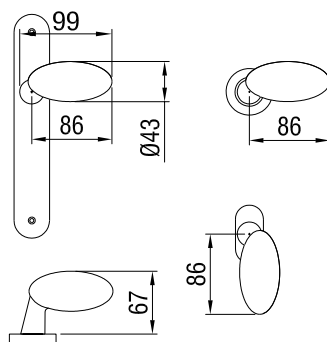

destra / right

348 PF 002-OSC



destra / right

348 PF 049-OSC



destra / right

348 PF R50-BG

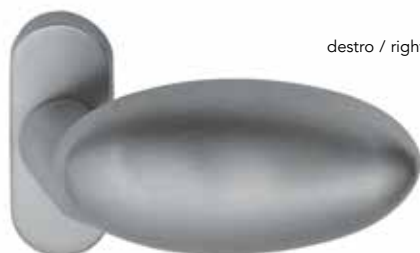

destra / right

348 PF C07-OSC



POMOLO SU ROSETTA CON FISSAGGIO A PIASTRINA / KNOB ON ROSE WITH FIXING BASE					LV BG	OSC OC	PVD	PVD INOX	
348 PF 002*	Pomolo Fisso con rosetta <i>Fixed Knob on rose</i>	002	mm Ø45X9	con piastrina <i>with fixing base</i>	•	•	•	•	2
348 PF 009*	Pomolo Fisso con rosetta <i>Fixed Knob on rose</i>	009	mm 62X32	con piastrina <i>with fixing base</i>	•	•	•	•	2
348 PF C07*	Pomolo Fisso con rosetta <i>Fixed Knob on rose</i>	C07	mm 67X27	con piastrina <i>with fixing base</i>	•	•	•		2
348 PF R50*	Pomolo Fisso con rosetta <i>Fixed Knob on rose</i>	R50	mm Ø50X9	con piastrina <i>with fixing base</i>	•	•			2
POMOLO SU PLACCA / KNOB ON PLATE									
348 PF 037*	Pomolo Fisso su placca <i>Fixed Knob on plate</i>	037	mm255X42	yale <i>yale</i>	•	•			2
348 PF 049*	Pomolo Fisso su placca <i>Fixed Knob on plate</i>	049	mm 265X55	yale <i>yale</i>	•	•	•	•	2

* Specificare se richiesto destro o sinistro
Please specify right or left

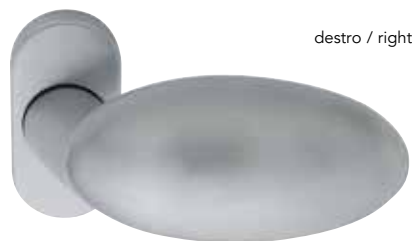

348 PF 009-OSC

destro / right



348 PF 037-LV

destro / right

art. 354 SPOST. QUADRO

design: St. Reguitti - Mod. Dep.
materiale: Impugnatura Zama
material: Lever Zamak

POMOLI FISSI/FIXED KNOBS

TeKnoMetal
Linea in zama

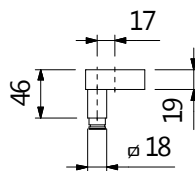

Destro - Right

354 PF 130 - ZSC



354 PF Q08 - ZSC



354 PF Q09 - ZSC

VERSIONI / VERSIONS



Finishes
Finiture

ZCR
ZSC

SNV



POMOLO SU PLACCA / KNOB ON PLATE

			€	€	
354 PF 130*	Pomolo fisso con placca Fixed knob on plate	130 mm 245x50	yale	•	• 2
354 PF Q08	Pomolo fisso con rosetta Fixed knob on rose	Q08 mm 50x50	con piastrina with fixing base	•	• 2
354 PF Q09	Pomolo fisso con rosetta Fixed knob on rose	Q09 mm 61x31	rettangolare con piastrina rectangular with fixing base	•	• 2



* Specificare se richiesto destro o sinistro

* Please specify right or left

art. 354 SPOST.QUADRO

design: St. Reguitti - Mod.Dep.
materiale: Impugnatura Zama
material: Lever Zamak

POMOLI GIREVOLI/DOOR KNOBSETS

TeKnoMetal
Linea in zama

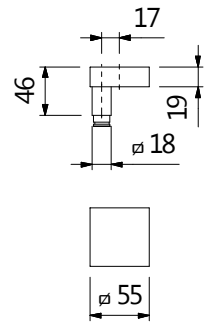

354 PR Q08 - ZSC



354 PR Q09 - ZSC

VERSIONI / VERSIONS





Finiture
Finishes

ZCR
ZSC

SNV



COPPIA POMOLO CON ROSETTA / PAIR KNOB ON ROSE

				€	€	
	354 PR Q08	Coppia pomolo con rosetta Pair knob on rose	Q08 mm 50x50	con grano with grub screw	•	• 1
	354 PR Q09	Coppia pomolo con rosetta Pair knob on rose	Q09 mm 62x32	con grano with grub screw	•	• 1

COPPIA POMOLO CON PLACCA / PAIR KNOB ON PLATE

				€	€	
	354 PP 130	Coppia pomolo con placca Pair knob on plate	130 mm 245x50	con grano with grub screw	•	• 1

art. 355 TRIAL

design: Studio Reguitti
 materiale: Ottone
 material: Solid Brass

Brass Class
 100% Ottone

POMOLI FISSI/FIXED KNOBS

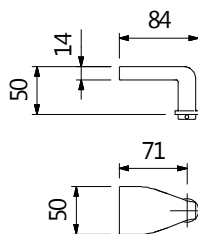

355 PF 130 - OSC

Destro - Right



355 PF Q09 - OC



355 PF Q08 - OSC

VERSIONI / VERSIONS





Finiture
Finishes

OC
OSC

SNV

PVD INOX



POMOLO SU ROSETTA CON FISSAGGIO A PIASTRINA / KNOB ON ROSE WITH FIXING BASE				€	€	€
	355 PF Q08	Pomolo fisso con rosetta Fixed knob on rose	Q08 mm 50x50 con piastrina with fixing base	•	•	• 2
	355 PF Q09	Pomolo fisso con rosetta Fixed knob on rose	Q09 mm 61x31 rettangolare con piastrina rectangular with fixing base	•	•	• 2
POMOLO SU PLACCA / KNOB ON PLATE				€	€	€
	355 PF 130*	Pomolo fisso con placca Fixed knob on plate	130 mm 245x50 yale yale	•	•	• 2

* Specificare se richiesto destro o sinistro

* Please specify right or left

art. 355 TRIAL

design: Studio Reguitti
 materiale: Ottone
 material: Solid Brass

Brass Class
 100% Ottone

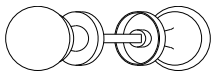
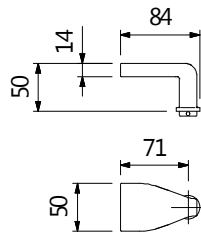

355 PR Q46 - OC



355 PR Q86 - OC



355 PR 9Q6 - OSC

VERSIONI / VERSIONS



Finiture
 Finishes

OC
 OSC

SNV

PVD INOX

COPPIA POMOLO CON ROSETTA / PAIR KNOB ON ROSE

			€	€	€			
	355 PR 9Q6	Coppia pomolo con rosetta Pair knob on rose	9Q6 mm 61x31	con molla with spring	•	•	•	1
	355 PR Q46	Coppia pomolo con rosetta Pair knob on rose	Q46 mm 45x45	con molla with spring	•	•	•	1
	355 PR Q86	Coppia pomolo con rosetta Pair knob on rose	Q86 mm 50x50	con molla with spring	•	•	•	1

A RICHIESTA / ON REQUEST:

- Mezza coppia pomolo con rosetta o con placca / Half pair knob on rose or plate
- Coppia pomolo con rosetta senza bocchetta / Pair knob on rose without rose for key



art. **382** GENTILE

Brass Class
100% Ottone

POMOLI FISSI/FIXED KNOBS

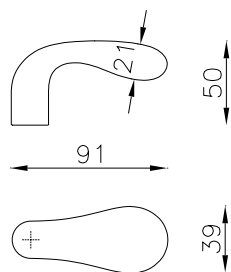

382 PF R50 - LV



destro / right

382 PF 037 - LV



382 PF 009 - BG



382 PF 002 - PVD

VERSIONI / VERSIONS



Finiture
Finishes



POMOLO SU ROSETTA CON FISSAGGIO A PIASTRINA / KNOB ON ROSE WITH FIXING BASE

					LV BG	OC OSC	PVD	
382 PF R50	Pomolo Fisso con rosetta Fixed Knob on rose	R50	mm Ø50x9	con piastrina with fixing base	•	•		2
382 PF 002	Pomolo Fisso con rosetta Fixed Knob on rose	002	mm Ø45x10	con piastrina with fixing base	•	•	•	2
382 PF 009	Pomolo Fisso con rosetta Fixed Knob on rose	009	mm 62x32	ovale con piastrina oval with fixing base	•	•	•	2
382 PF C07	Pomolo Fisso con rosetta Fixed Knob on rose	C07	mm 67x27	ovale stretta con piastrina oval and reduced with fixing base	•	•	•	2

POMOLO SU PLACCA / KNOB ON PLATE

382 PF 037*	Pomolo Fisso con placca Fixed Knob on plate	037	mm 255x42	yale yale	•	•		2
-------------	--	-----	-----------	--------------	---	---	--	---

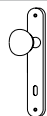

* Specificare se richiesto destro o sinistro
Please specify right or left



382 PF 009 - OSC



382 PF C07 - OC

PORTE E FINESTRE SCORREVOLI

SLIDING DOOR AND WINDOW HANDLES



Novità Q70



art.
70 PI

pag. 618



art.
573 CP

pag. 627



art.
577 CP 00Q

pag. 638



art.
573 CP 00Q

pag. 629



art.
578 CP

pag. 639



art.
70 CP

pag. 619



art.
574 CP

pag. 630



art.
578 CP 00Q

pag. 640



art.
508 CP Q70

pag. 620



art.
574 CP 00Q

pag. 631



art.
508 CP

pag. 641



art.
575 CP Q70

pag. 621



art.
575 CP

pag. 632



art.
508 CP 00F

pag. 642

Kit e coppie placche incasso tonde e quadre per serratura con 



art.
575 CP 00Q

pag. 633



art.
508 CP 00Q

pag. 643



art.
801 CP

pag. 622



art.
575 CP 518

pag. 634



art.
538 CP

pag. 644



art.
801 CP 00Q

pag. 623



art.
576 CP

pag. 635



art.
538 CP 00Q

pag. 645



art.
873 CP

pag. 625



art.
576 CP 00Q

pag. 636



art.
570 CP

pag. 646



art.
873 CP 00Q

pag. 626



art.
577 CP

pag. 637



art.
519 CP

pag. 647



art.
519 CP 00F

pag. 648



art.
875 CP

pag. 658



art.
515 CP

pag. 667



art.
542 CP

pag. 649



art.
877 CP

pag. 659



art.
545 CP

pag. 668



art.
518 CP

pag. 650

Kit e coppie placche incasso
ovali e rettangolari
per serratura con 



art.
555 CP

pag. 669



art.
540 CP

pag. 651



art.
506 CP 00A

pag. 660



art.
535 CP

pag. 670



art.
559 CP

pag. 652



art.
556 CP

pag. 661



art.
536 CP

pag. 671



art.
559 CP 00F

pag. 653



art.
514 CP

pag. 662



art.
552 CP

pag. 672



art.
559 CP 00Q

pag. 654



art.
544 CP

pag. 663



art.
952 CP

pag. 673



art.
560 CP

pag. 655



art.
554 CP

pag. 664



art.
935 CP C00

pag. 674



art.
560 CP 00Q

pag. 656



art.
504 CP

pag. 665



art.
935 CP B00

pag. 675



art.
808 CP

pag. 657



art.
553 CP

pag. 666



art.
950 CP C00

pag. 676



art.
951 CP C00

pag. 677



art.
Q28 PI

pag. 686



art.
252 PI

pag. 695



art.
914 CP

pag. 678



art.
534 PI

pag. 687

Articoli vari e accessori



art.
944 CP

pag. 679



art.
808 PI

pag. 688



art.
580 CP

pag. 696



art.
954 CP



pag. 680

Kit e coppie placche incasso
ovali e rettangolari
per serratura con  



art.
581 CP

pag. 696

Kit e coppie placche incasso
tonde e quadre
per serratura con  



art.
805 PI

pag. 689



art.
582 CP

pag. 696



art.
802 PI

pag. 681



art.
Q85 PI

pag. 690



art.
051 PI

pag. 697



art.
Q82 PI

pag. 682



art.
520 PI

pag. 691



art.
525 PI

pag. 698



art.
524 PI

pag. 683



art.
521 PI

pag. 692



art.
Q25 PI

pag. 698



art.
Q24 PI

pag. 684



art.
535 PI

pag. 693



art.
524 RO

pag. 698



art.
529 PI

pag. 685



art.
Q35 PI

pag. 694



UMI

pag. 699



art.
429 PI

pag. 700



art.
Q30 PI

pag. 702



art.
523 PI

pag. 705



art.
Q29 PI

pag. 700



art.
543 CP 00Q

pag. 702



art.
531 PI

pag. 705



art.
048 PI

pag. 700



art.
524 CP

pag. 703



art.
6 SR

pag. 706



art.
048 CP

pag. 700



art.
529 CP

pag. 703



art.
7 SR

pag. 707



art.
Q48 PI

pag. 701



art.
536 PI

pag. 703

PER VETRO / FOR GLASS



art.
11 SR

pag. 708



art.
048 CP 00Q

pag. 701



art.
532 PI

pag. 704



art.
16 SR

pag. 708



art.
803 PI

pag. 701



art.
533 PI

pag. 704



art.
17 SR

pag. 708



art.
Q83 PI

pag. 701



art.
526 PI

pag. 704



art. **12 SR**

art. **13 SR**

pag. 709-710



art.
530 PI

pag. 702



art.
527 PI

pag. 704



art.
006 IN

pag. 709-710



art.
543 CP

pag. 702



art.
522 PI

pag. 705



art.
007 CH

pag. 710

Schemi di Foratura Porte

Door Drilling Drawings

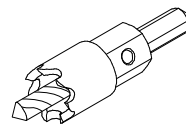

S1

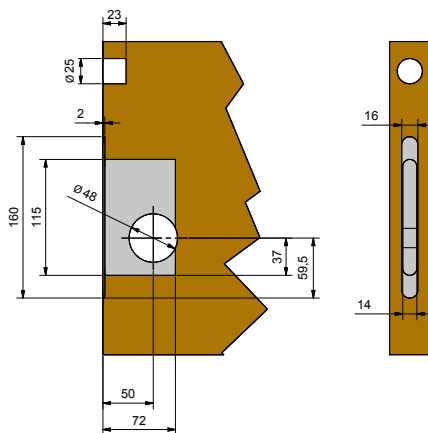

Per KIT **con serratura** E=50:
For set **with lock** backset=50:

CD041 - 042 - 044 - 045 - 049 - 050 - 051 - 053 - 055 - 061 - 063 - 064 - 066 - 073 - 075 - 076 - 082 - 084 - 087 - 089 - 095 - 099 - 623 - 624 - 626 - 650 - 652 - 654 - 656 - 658 - 660 - 666 - 667 - 668 - 669 - 670 - 671 - 672 - 673 - 674 - 675 - 677 - 679 - 681 - 683 - 684 - 6D4 - 703 - 705 - 713 - 715 - 723 - 725 - 801 - 802 - 803 - 804 - 805 - 806 - 807 - 808 - 809 - 810 - 811 - 812 - 813 - 821 - 822 - 823 - 824 - 825 - 826 - 827 - 829 - 830 - 831 - 834 - 835 - 850 - 851 - 863 - 876 - D42 - D44 - D50 - D51 - D4Q - D5Q - F44 - F45 - F50 - F51 - F65 - Q44 - Q50 - Q51 - Q63 - Q77 - Q85 - QD1 - F87 - D89 - S50

S2

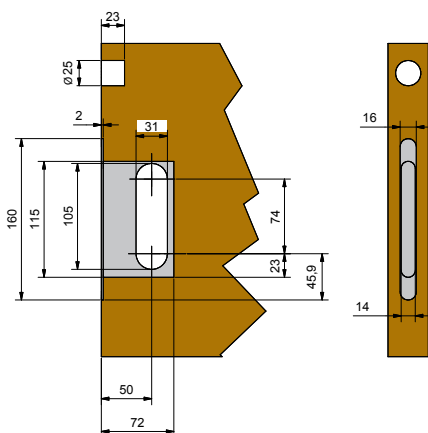

Per KIT **con serratura** E=50:
For set **with lock** backset=50:
CD046 - 054 - 946 - 9D6 - D46 - D54

S3

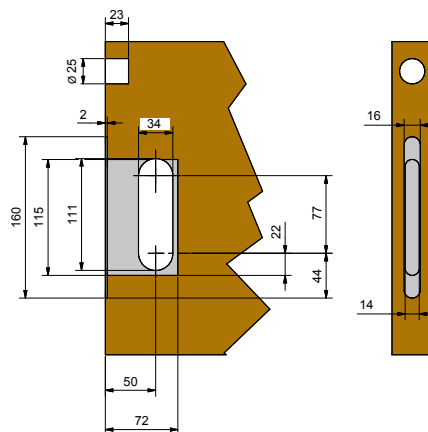

Per KIT **con serratura** E=50:
For set **with lock** backset=50:
CD048 - 058 - D48 - D58

Schemi di Foratura Porte

Door Drilling Drawings

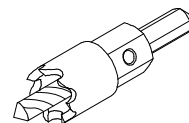

S4

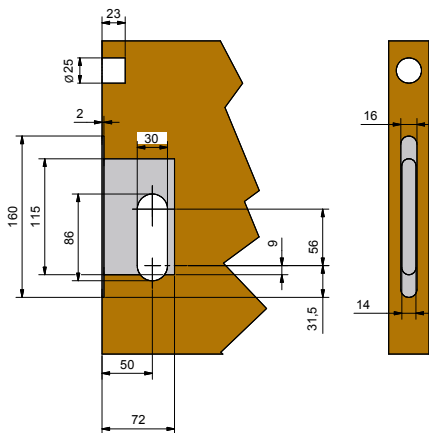

Per KIT **con serratura** E=50:

For set **with lock** backset=50:

CD060 - 60D - D60 - 068 - 069 - 69D - D69 -
960 - 968 - 969

S5

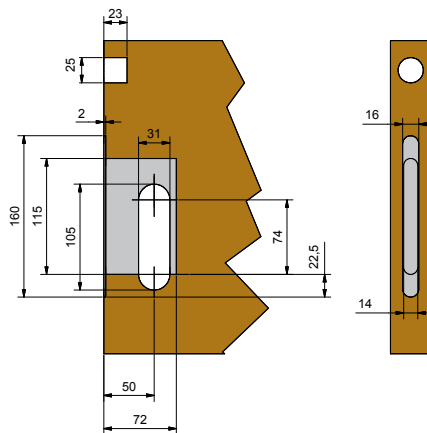

Per KIT **con serratura** E=50:

For set **with lock** backset=50:

CD070 - CD079

S6

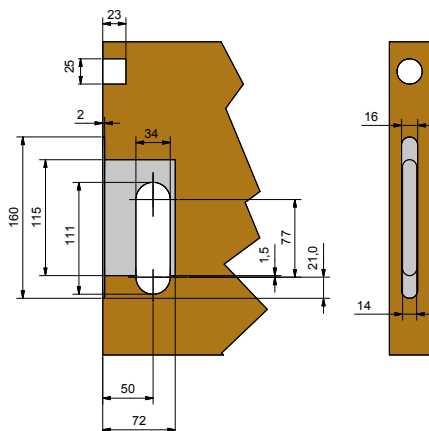

Per KIT **con serratura** E=50:

For set **with lock** backset=50:

CD081

S7

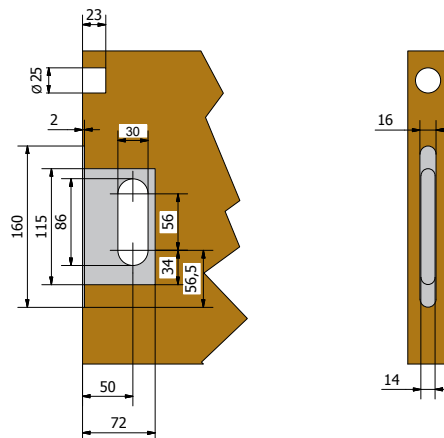

Per KIT **con serratura** E=50:

For set **with lock** backset=50:

CD062 - 62D - D62 - 962

Schemi di Foratura Porte

Door Drilling Drawings

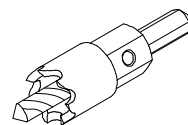

S8

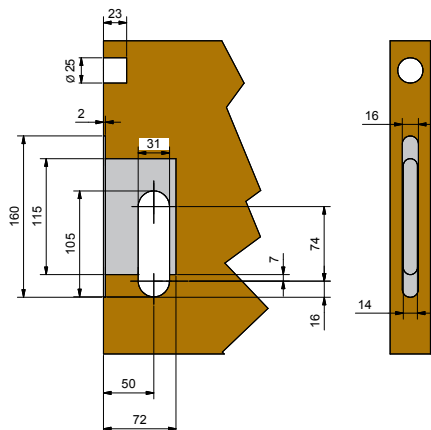

Per KIT **con serratura** E=50:
For set **with lock** backset=50:

CD065 - 865 - 965 - 96Y - Y65

S9

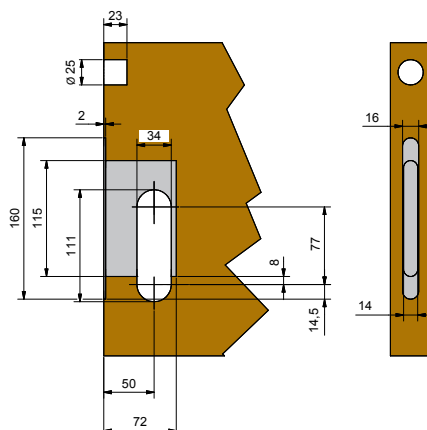

Per KIT **con serratura** E=50:
For set **with lock** backset=50:

CD067 CD867 CDY67

S10

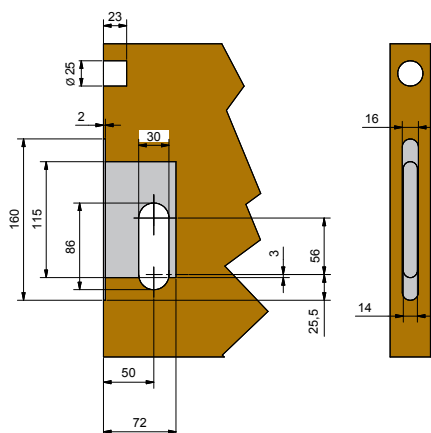

Per KIT **con serratura** E=50:
For set **with lock** backset=50:

CD056 - 956 - Y56 - YR6

S11

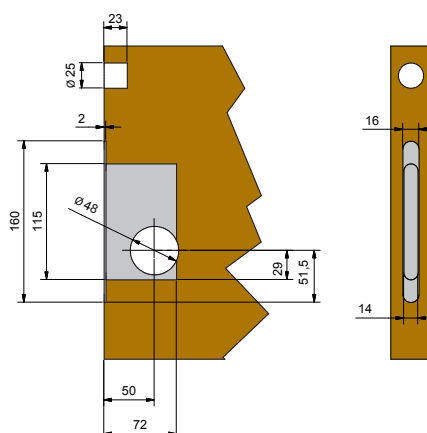

Per KIT **con serratura** E=50:
For set **with lock** backset=50:

CD Q6Y - QY7 - Y63

Schemi di Foratura Porte

Door Drilling Drawings

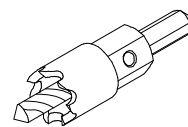

S12

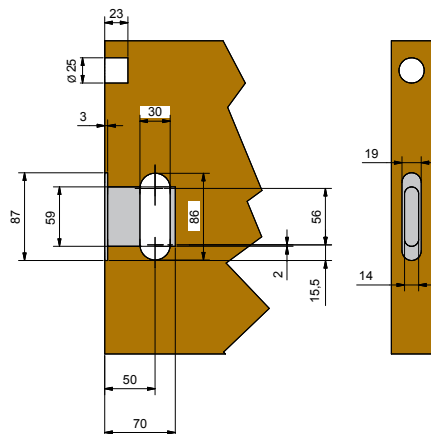

Per KIT **con serratura** E=50:
For set **with lock** backset=50:
CD68S - 96S

S13

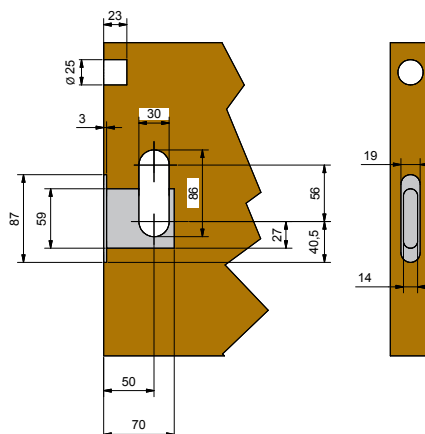

Per KIT **con serratura** E=50:
For set **with lock** backset=50:
CD92S

Utensile guida per posizionamento
incontro serrature a gancio
Tool position guide for hook lock striker

S14

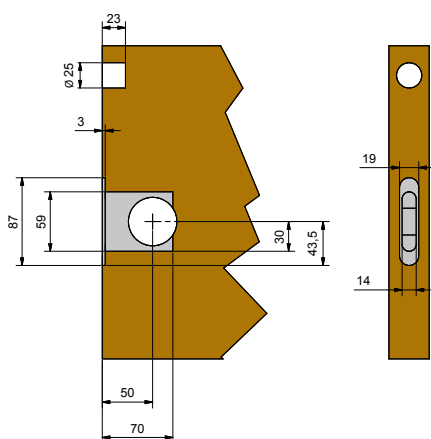

Per KIT **con serratura** E=50:
For set **with lock** backset=50:

CD090 - 091 - 092 - 096 - 651 - 653 - 655 - 657 - 659 - 661
- 662 - 663 - 664 - 665 - 676 - 678 - 680 - 682 - 76S - 82S
- 83S - D90 - D91 - D92 - Q90 - Q91 - S90 - QD9

BPLTPKSR6**4A***

UMI



Se ne consiglia l'uso per i KIT con serrature

6SR - 7SR - 16SR - 17SR - 11SR

in quanto ideato per risolvere i problemi
legati al centraggio della serratura e
contropiastra in cantiere.

TIPI DI INSTALLAZIONE INSTALLATION TYPES



MONTAGGIO S

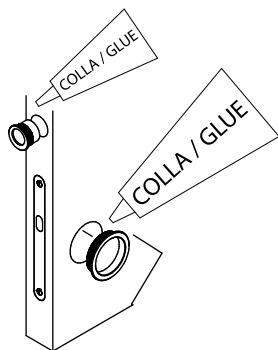

MONTAGGIO V

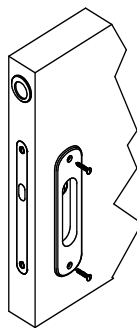

MONTAGGIO P

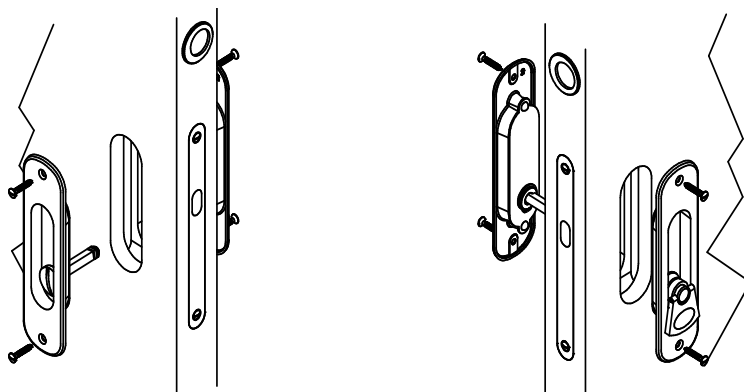

MONTAGGIO G

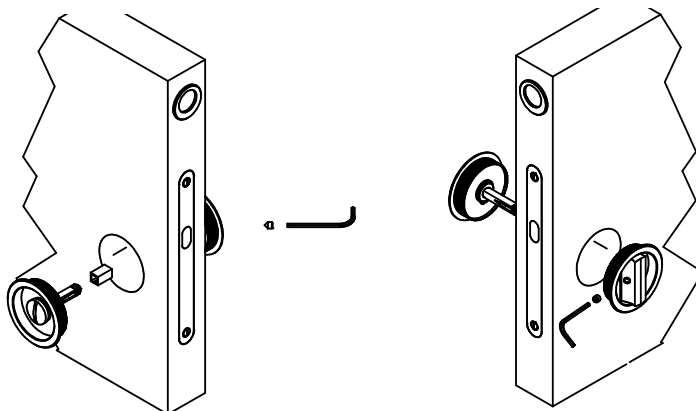

TIPI DI INSTALLAZIONE INSTALLATION TYPES



MONTAGGIO D

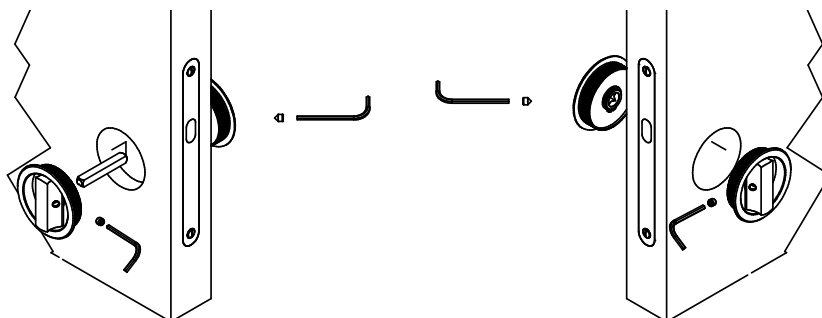

MONTAGGIO T

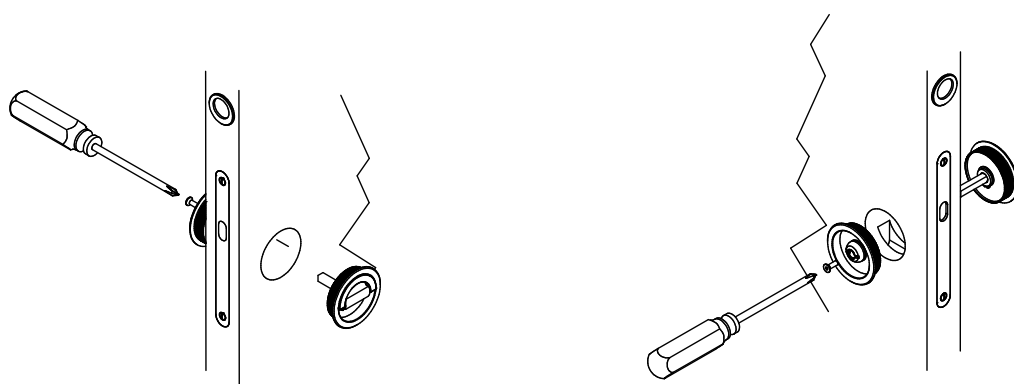

MONTAGGIO F

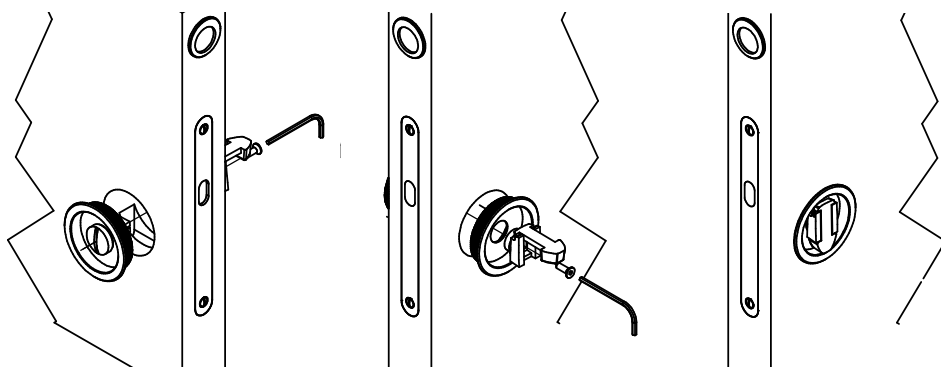

art. **Q70** Placca incasso quadra mm 70x70
 Square sliding door plate mm 70x70

TeKnoMetal
 Linea in zama



Q70 PI 002-ZSC



Q70 PI 001-ZSC



Q70 PI 011-ZSC

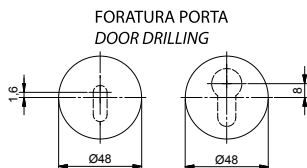
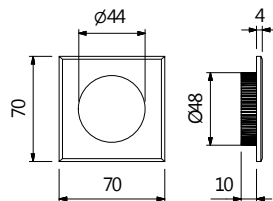

ART.				ZSC	SNV	
Q70 PI 001	Con foro chiave With key hole		S	•	•	12
Q70 PI 002	Cieca Blind		S	•	•	12
Q70 PI 011	Con foro yale Europrofile cylinder (yale)		S	•	•	12

KIT

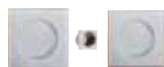

CD Q72-ZSC



CD Q73-ZSC



CD Q7Y-ZSC



CD Q77-ZSC



CD QY7-ZSC

ART.				ZSC	SNV	
CD Q72	Set con 2 art. Q70 PI 002 + art Q25 PI senza serratura Set with 2 art. Q70 PI 002 + art. Q25 PI without lock			•	•	1
CD Q73	Set con 2 art. Q70 PI 001 + art Q25 PI senza serratura Set with 2 art. Q70 PI 001 + art. Q25 PI without lock			•	•	1
CD Q7Y	Set con 2 art. Q70 PI 011 + art Q25 PI senza serratura Set with 2 art. Q70 PI 011 + art. Q25 PI without lock			•	•	1
CD Q77	Set con serratura 7SR E=50 con chiave snodata Set with lock 7SR backset=50 with pliable key		S1	•	-	1
CD QY7	Set con serratura 11SR E=50 Set with lock 11SR backset=50		S11	•	-	1



35-50

per/for CD Q77

art. **Q70**

Coppia placche incasso quadre mm 70x70 con nottolino Q70
 Pair square sliding door plates mm 70x70 with Q70 turn

TeKnoMetal
 Linea in zama



Q70 CP Q70-ZSC

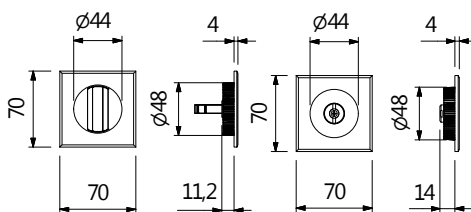

ART.

Q70 CP Q70

Coppia placche incasso
 Pair sliding door plates



ZSC

SNV



T

•

•

6

KIT

CD 701-ZSC

CD 703-ZSC

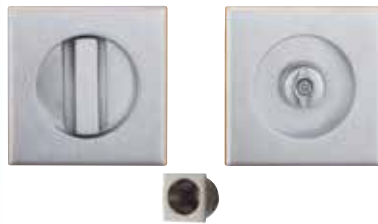
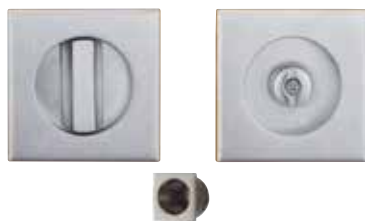

ART.

CD 701

Set con art. Q70 CP Q70 + art. Q25 PI senza serratura
 Set with art. Q70 CP Q70 + art. Q25 PI without lock

CD 703

Set con serratura 6SR E=50
 Set with lock 6SR backset=50



ZSC

SNV



S1

•

-

1

A richiesta disponibile kit con 16SR TEKNO - art. CD 705



16SR

specifiche tecniche serrature
 a fine capitolo

art. **508** Coppia placche incasso quadre mm70x70 con nottolino 508
Pair square sliding door plates mm 70x70 with 508 turn

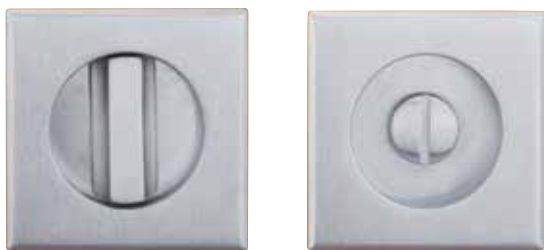

508 CP Q70-OSC

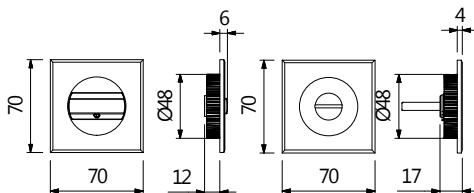

regolabilità standard*



* A richiesta disponibile articolo con ferro per spessori porta da 35 a 39 o da 45 a 52 specificando sempre sull'ordine l'esatto spessore porta.

* On request item available for different door thickness

ART.				OSC	SNV	
508 CP Q70	Coppia placche incasso Pair sliding door plates			G	•	

KIT

CD 711-OSC

CD 713-OSC

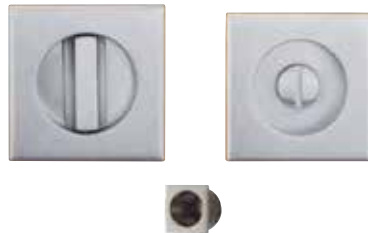
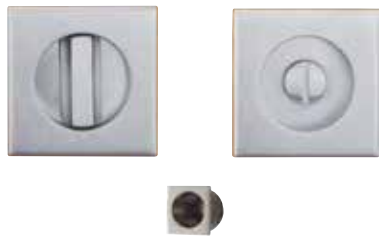

ART.				OSC	SNV	
CD 711	Set con art. Q70 CP Q70 + art 525 PI senza serratura Set with art. Q70 CP Q70 + art. 525 PI without lock			•	•	
CD 713	Set con serratura 6SR E=50 Set with lock 6SR backset=50	S1	•	-	1	

A richiesta disponibile kit con 16SR TEKNO - art. CD 715



specifiche tecniche serrature
a fine capitolo

art. **575** Coppia placche incasso quadre mm70x70 con nottolino 575 ad anello
Pair square sliding door plates mm 70x70 with 575 flush pull ring and turn

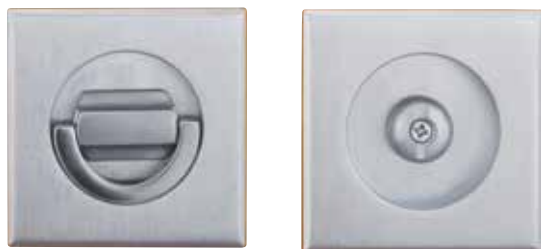

575 CP Q70-OSC

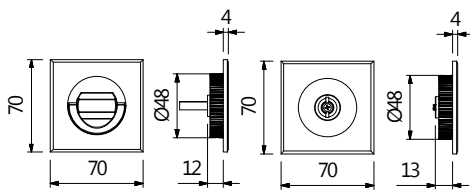

regolabilità standard*

* A richiesta disponibile articolo con ferro per spessori porta da 35 a 39 o da 45 a 50 specificando sempre sull'ordine l'esatto spessore porta.

* On request item available for different door thickness

ART.				OSC	SNV	
575 CP Q70	Coppia placche incasso Pair sliding door plates					

KIT

CD 721-OSC

CD 723-OSC

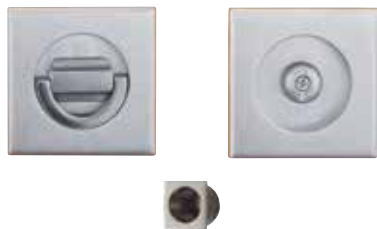

ART.				OSC	SNV	
CD 721	Set con art. Q70 CP Q70 + art 525 PI senza serratura Set with art. Q70 CP Q70 + art. 525 PI without lock					
CD 723	Set con serratura 6SR E=50 Set with lock 6SR backset=50		S1	•	-	1

A richiesta disponibile kit con 16SR TEKNO - art. CD 725



specifiche tecniche serrature
a fine capitolo

art. 801

Coppia placche incasso con nottolino Flat

Pair sliding door plates with Flat turn

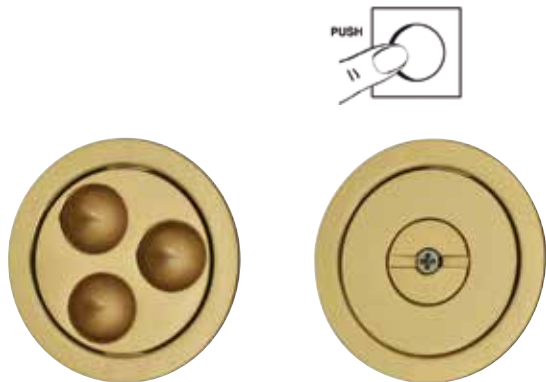

801 CP-LV

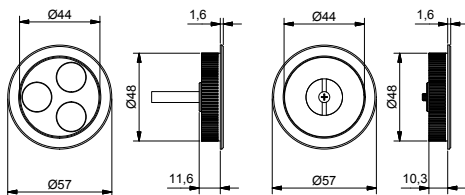

regolabilità standard*



* A richiesta disponibile articolo con ferro per spessori porta da 45 a 52 specificando sempre sull'ordine l'esatto spessore porta.

* on request item available for different door thickness

ART.

801 CP

Coppia placche incasso
Pair sliding door plates



	LV	OSC OC	
T	•	•	6

KIT

CD 636-OC



CD 675-OSC



ART.

CD 636

Set con art. 801 CP + art 525 PI senza serratura
Set with art. 801 CP + art. 525 PI without lock

CD 675

Set con serratura 6SR E=50
Set with lock 6SR backset=50



	LV	OSC OC	
S1	•	•	1

A richiesta disponibile kit con 12SR SMART - art. CD 676



12SR

specifiche tecniche serrature
a fine capitolo

art. 801

Coppia placche incasso quadre con nottolino Flat

Square pair sliding door plates with Flat turn

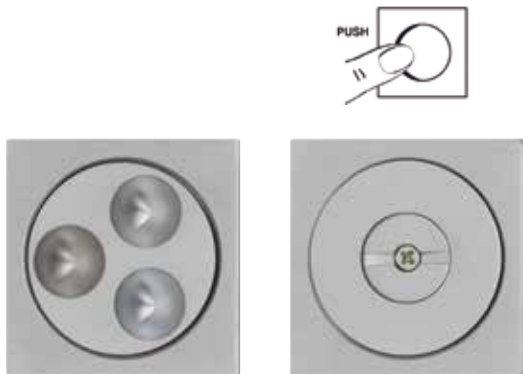

801 CP 00Q-OSC

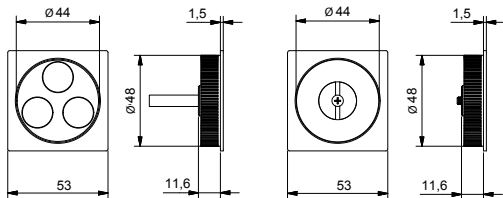

40-45

regolabilità standard*



* A richiesta disponibile articolo con ferro per spessori porta da 45 a 52 specificando sempre sull'ordine l'esatto spessore porta.

* on request item available for different door thickness

ART.

801 CP 00Q

Coppia placche incasso
Pair sliding door plates

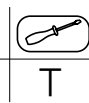

KIT

CD 638-OC

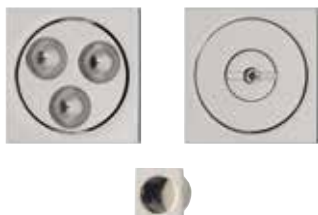

CD 679-OSC



ART.

CD 638

Set con art. 801 CP 00Q + art. Q25 PI senza serratura
Set with art. 801 CP 00Q + art. Q25 PI without lock

CD 679

Set con serratura 6SR E=50
Set with lock 6SR backset=50

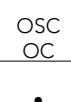
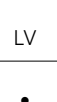

S1

A richiesta disponibile kit con 12SR SMART - art. CD 680



12SR

specifiche tecniche serrature
a fine capitolo

NOTTOLINO TRADIZIONALE 508
TRADITIONAL 508 TURN

NUOVO NOTTOLINO 873
NEW 873 TURN

1. SPORGENZA RIDOTTA
LOW PROJECTION

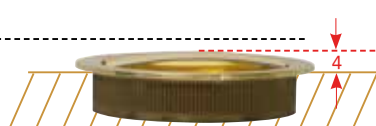
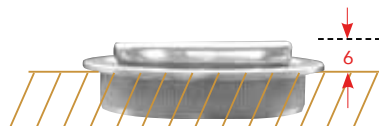

2. FERRO $\varnothing 8$

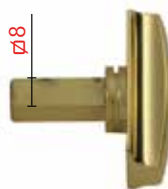
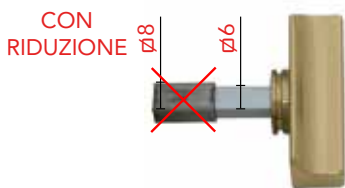

3. VITE PREMONTATA SU INCONTRO FILETTATO
(nessuna confezione interna da aprire)



Vite premontata



4. VELOCITA' DI MONTAGGIO

Tempi di montaggio senza paragone



5. NUOVA CONFEZIONE SALVASPAZIO
(ingombro ridotto del 50%)
CON E SENZA SERRATURA

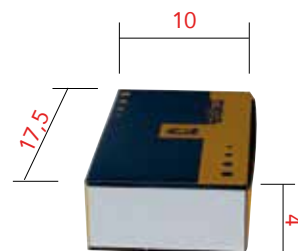

*valori soggettivi rilevati in test di laboratorio Reguitti S.p.A

art. 873

Coppia placche incasso con nottolino 873

Pair sliding door plates with 873 turn

TeKnoMetal
Linea in zama



873 CP-OTT.BRILL

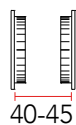
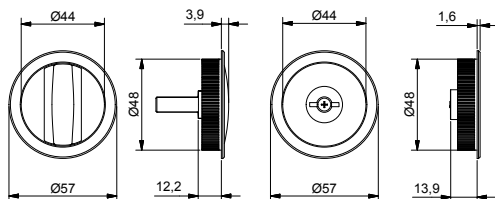

40-45

regolabilità standard*



* A richiesta disponibile articolo con ferro per spessori porta da 35 a 39 o da 45 a 48 specificando sempre sull'ordine l'esatto spessore porta.

* on request item available for different door thickness

ART.

873 CP

Coppia placche incasso
Pair sliding door plates

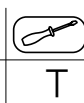

OTT.
BRILL

ZSC
ZCR

ZSO
ZBG

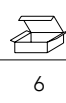

6

KIT

CD 820-OTT.BRILL

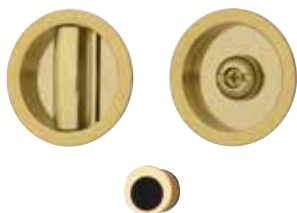

CD 821-ZSC



ART.

CD 820

Set con art. 873 CP + art 525 PI senza serratura
Set with art. 873 CP + art. 525 PI without lock



OTT.
BRILL

ZSC
ZCR

ZSO
ZBG

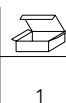

1

CD 821

Set con serratura 6SR E=50
Set with lock 6SR backset=50

S1

1

A richiesta disponibile kit con 12SR SMART - art. CD 825
A richiesta disponibile kit con 16SR TEKNO - art. CD 823



12SR



16SR

specifiche tecniche serrature
a fine capitolo

art. 873

Coppia placche incasso con nottolino ad anello

Pair sliding door plates with flush pull ring

TeKnoMetal
Linea in zama



873 CP 00Q-ZSC

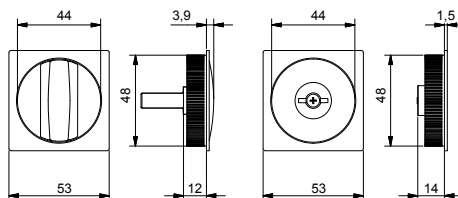

regolabilità standard*

* A richiesta disponibile articolo con ferro per spessori porta da 35 a 39 o da 45 a 48 specificando sempre sull'ordine l'esatto spessore porta.

* on request item available for different door thickness

ART.

873 CP 00Q

Coppia placche incasso
Pair sliding door plates

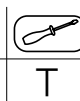

ZSC
•

ZCR
•

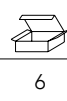

KIT

CD 828-ZSC



CD 829-ZSC



ART.

CD 828

Set con art. 873 CP 00Q + art Q25 PI senza serratura
Set with art. 873 CP 00Q + art. Q25 PI without lock

CD 829

Set con serratura 6SR E=50
Set with lock 6SR backset=50



ZSC
•

ZCR
•



A richiesta disponibile kit con 12SR SMART - art. CD 835
A richiesta disponibile kit con 16SR TEKNO - art. CD 830



12SR



16SR

specifiche tecniche serrature
a fine capitolo

art. **573**

Coppia placche incasso con nottolino 573

Pair sliding door plates with 573 turn

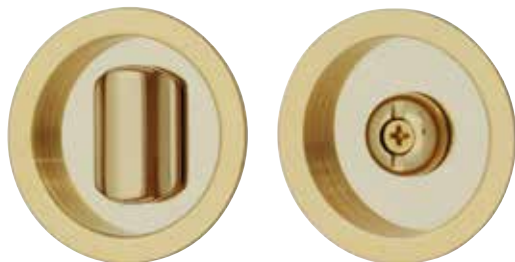

573 CP-LV

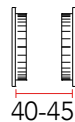
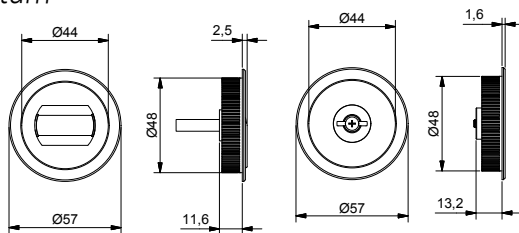

regolabilità standard*



* A richiesta disponibile articolo con ferro per spessori porta da 30 a 39 o da 45 a 49 specificando sempre sull'ordine l'esatto spessore porta.

* on request item available for different door thickness

ART.				LV BG	OSC OC	AN	AGV	
573 CP	Coppia placche incasso Pair sliding door plates		T	•	•	•	•	6

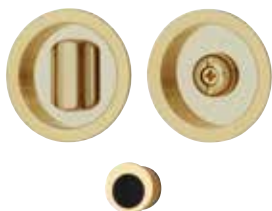

KIT

CD 615-LV



CD 650-OSC



ART.				LV BG	OSC OC	AN	AGV	
CD 615	Set con art. 573 CP + art 525 PI senza serratura Set with art. 573 CP + art. 525 PI without lock			•	•	•	•	1
CD 650	Set con serratura 6SR E=50 Set with lock 6SR backset=50		S1	•	•	•	•	1

A richiesta disponibile kit con 12SR SMART - art. CD 651
A richiesta disponibile kit con 16SR TEKNO - art. CD 801



12SR



16SR

specifiche tecniche serrature
a fine capitolo

art. 573

Coppia placche incasso con notolino 573 con libero/occupato
 Pair sliding door plates with 573 turn and indicator for wc

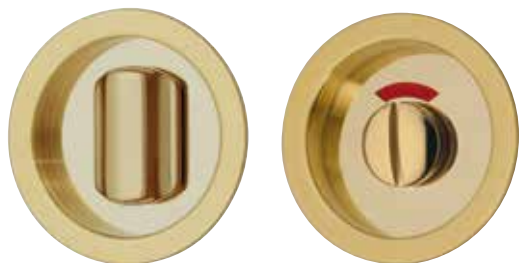

573 CP 00F-LV

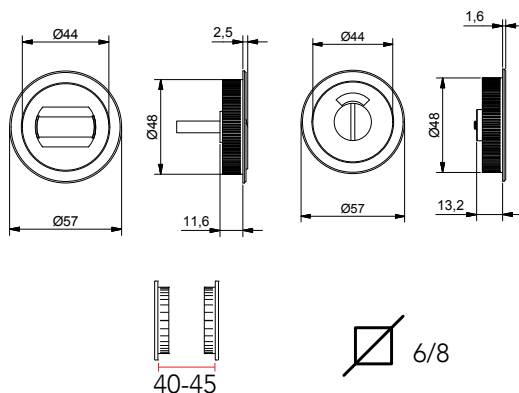

regolabilità standard*



* A richiesta disponibile articolo con ferro per spessori porta da 30 a 39 o da 45 a 49 specificando sempre sull'ordine l'esatto spessore porta.

* on request item available for different door thickness

ART.

573 CP 00F

Coppia placche incasso con notolino 573 con libero/occupato
 Pair sliding door plates with 573 turn and indicator for wc



LV
BG

OSC
OC

AN

AGV



G

•

•

•

•

6

KIT

CD F61-LV

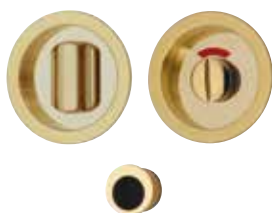

CD F65-OSC



ART.

CD F61

Set con art. 573 CP 00F + art 525 PI senza serratura
 Set with art. 573 CP 00F + art. 525 PI without lock

CD F65

Set con serratura 6SR E=50
 Set with lock 6SR backset=50



LV
BG

OSC
OC

AN

AGV



S1

•

•

•

•

1

art. **573** Coppia placche incasso con nottolino 573
Pair sliding door plates with 573 turn

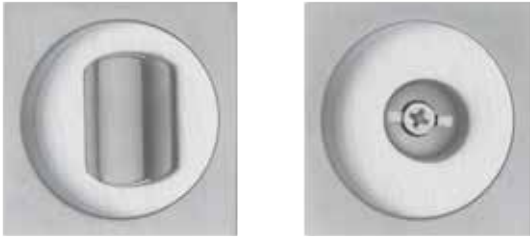

573 CP 00Q-OSC

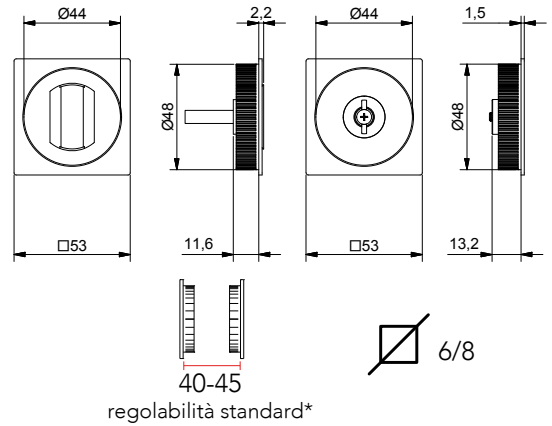

* A richiesta disponibile articolo con ferro per spessori porta da 30 a 39 o da 45 a 49 specificando sempre sull'ordine l'esatto spessore porta.

* on request item available for different door thickness

ART.

573 CP 00Q

Coppia placche incasso
Pair sliding door plates

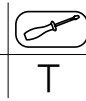

LV

OSC

OC

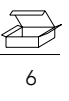

T

•

•

•

6

KIT

CD 616-OSC



CD 652-OSC



ART.

CD 616

Set con art. 573 CP 00Q + art. Q25 PI senza serratura
Set with art. 573 CP 00Q + art. Q25 PI without lock

CD 652

Set con serratura 6SR E=50
Set with lock 6SR backset=50



LV

OSC

OC



S1

•

•

•

1

A richiesta disponibile kit con 12SR SMART - art. CD 653
 A richiesta disponibile kit con 16SR TEKNO - art. CD 802



12SR



16SR

specifiche tecniche serrature
 a fine capitolo

art. **574** Coppia placche incasso con nottolino 573 da ambo i lati
Pair sliding door plates with 573 turn on both sides

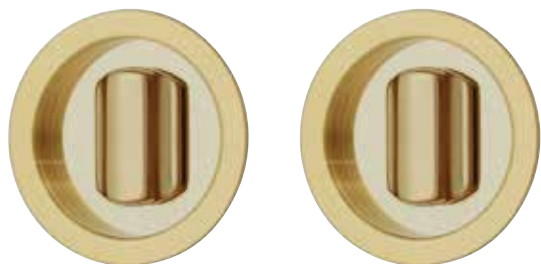

574 CP-LV

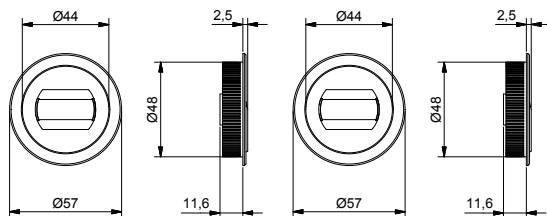

40-47

regolabilità standard*



* A richiesta disponibile articolo con ferro per spessori porta da 30 a 39 o da 45 a 50 specificando sempre sull'ordine l'esatto spessore porta.

* on request item available for different door thickness

ART.				LV BG	OSC OC	AN	AGV	
574 CP	Coppia placche incasso <i>Pair sliding door plates</i>		D	•	•	•	•	6

KIT

CD 617-LV

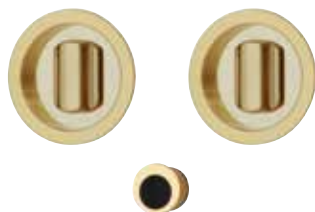

CD 654-LV

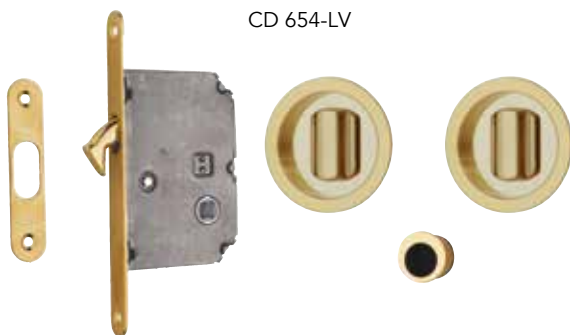

ART.				LV BG	OSC OC	AN	AGV	
CD 617	Set con art. 574 CP + art 525 PI senza serratura <i>Set with art. 574 CP + art. 525 PI without lock</i>			•	•	•	•	1
CD 654	Set con serratura 6SR E=50 <i>Set with lock 6SR backset=50</i>		S1	•	•	•	•	1

A richiesta disponibile kit con 12SR SMART - art. CD 655
 A richiesta disponibile kit con 16SR TEKNO - art. CD 803



12SR



16SR

specifiche tecniche serrature
a fine capitolo

art. 574

Coppia placche incasso con nottolino 573 da ambo i lati

Pair sliding door plates with 573 turn on both sides

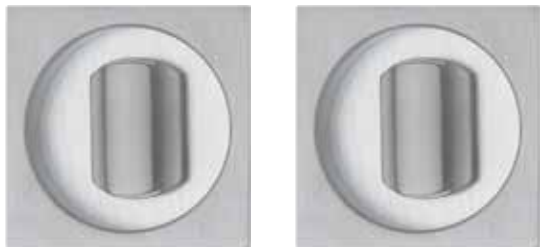

574 CP 00Q-OSC

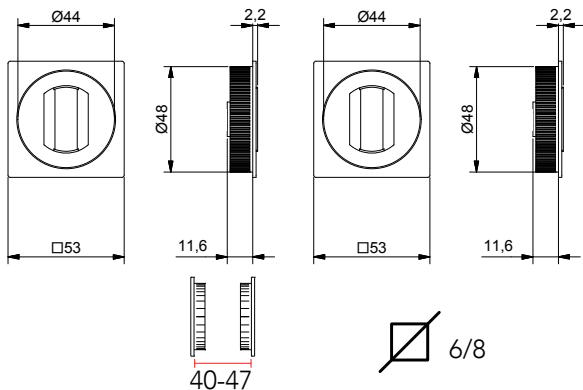

regolabilità standard*

* A richiesta disponibile articolo con ferro per spessori porta da 30 a 39 o da 45 a 50 specificando sempre sull'ordine l'esatto spessore porta.

* on request item available for different door thickness

ART.

574 CP 00Q

Coppia placche incasso
Pair sliding door plates



	LV	OSC	OC	
D	•	•	•	6

KIT

CD 618-OSC

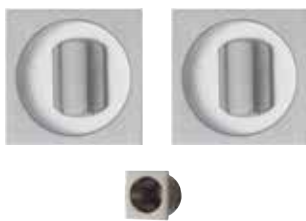

CD 656-OSC



ART.

CD 618

Set con art. 574 CP 00Q + art Q25 PI senza serratura
Set with art. 574 CP 00Q + art. Q25 PI without lock

CD 656

Set con serratura 6SR E=50
Set with lock 6SR backset=50



	LV	OSC	OC	
D	•	•	•	1
S1	•	•	•	1

A richiesta disponibile kit con 12SR SMART - art. CD 657
A richiesta disponibile kit con 16SR TEKNO - art. CD 804



specifiche tecniche serrature
a fine capitolo

art. **575** Coppia placche incasso con nottolino 575 ad anello
Pair sliding door plates with 575 flush pull ring and turn

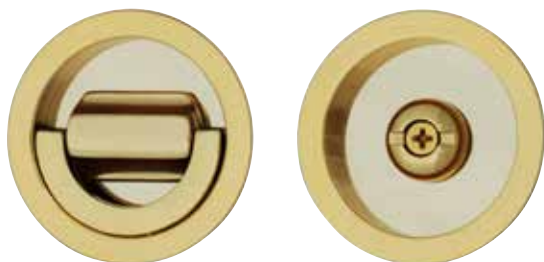

575 CP-LV

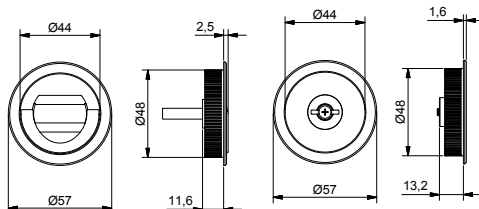

40-45

regolabilità standard*



* A richiesta disponibile articolo con ferro per spessori porta da 30 a 39 o da 45 a 49 specificando sempre sull'ordine l'esatto spessore porta.

* on request item available for different door thickness

ART.				LV BG	OSC OC	AN	AGV	VBN	
575 CP	Coppia placche incasso <i>Pair sliding door plates</i>		T	•	•	•	•	•	6

KIT

CD 619-LV

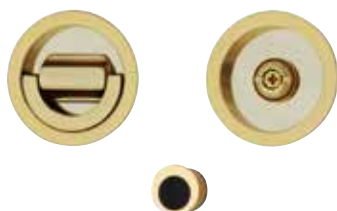

CD 658-LV



ART.				LV BG	OSC OC	AN	AGV	VBN	
CD 619	Set con art. 575 CP + art 525 PI senza serratura <i>Set with art. 575 CP + art. 525 PI without lock</i>			•	•	•	•	•	1
CD 658	Set con serratura 6SR E=50 <i>Set with lock 6SR backset=50</i>		S1	•	•	•	•	•	1

A richiesta disponibile kit con 12SR SMART - art. CD 659
 A richiesta disponibile kit con 16SR TEKNO - art. CD 805



12SR



16SR

specifiche tecniche serrature
a fine capitolo

art. **575** Coppia placche incasso con nottolino 575 ad anello
Pair sliding door plates with 575 flush pull ring and turn



575 CP 00Q-OSC

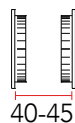
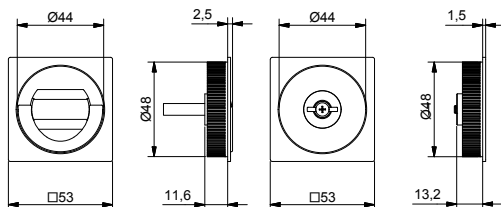

regolabilità standard*



* A richiesta disponibile articolo con ferro per spessori porta da 30 a 39 o da 45 a 49 specificando sempre sull'ordine l'esatto spessore porta.

* on request item available for different door thickness

ART.
575 CP 00Q

Coppia placche incasso
Pair sliding door plates

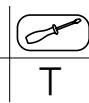

LV
•

OSC
OC
•

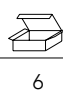

KIT

CD 620-OSC



CD 660-OSC



ART.
CD 620

Set con art. 575 CP 00Q + art. Q25 PI senza serratura
Set with art. 575 CP 00Q + art. Q25 PI without lock



LV
•

OSC
OC
•

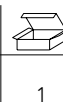

CD 660

Set con serratura 6SR E=50
Set with lock 6SR backset=50

S1

•

•



A richiesta disponibile kit con 12SR SMART - art. CD 661
 A richiesta disponibile kit con 16SR TEKNO - art. CD 806



12SR



16SR

specifiche tecniche serrature
a fine capitolo

art. **575** Coppia placche incasso con bordo di presa e nottolino 575
Pair sliding door plates with 575 turn and release with rim grip

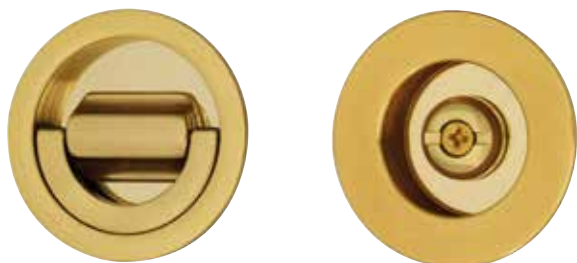

575 CP 518-LV

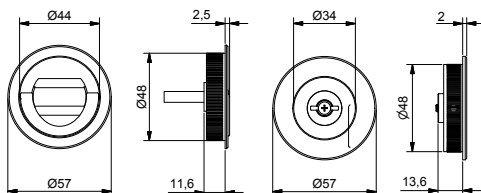

regolabilità standard*



* A richiesta disponibile articolo con ferro per spessori porta da 30 a 39 o da 45 a 49 specificando sempre sull'ordine l'esatto spessore porta.

* on request item available for different door thickness

ART.
575 CP 518

Coppia placche incasso
Pair sliding door plates



	LV BG VBN	OSC OC	AN	AGV	
T	•	•	•	•	6

KIT

CD 098-LV

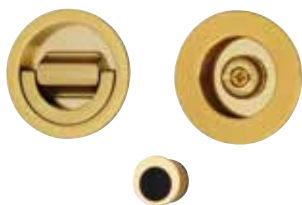

CD 099-LV



ART.

CD 098

Set con art. 575 CP 518 + art. 525 PI senza serratura
Set with art. 575 CP 518 + art. 525 PI without lock

CD 099

Set con serratura 6SR E=50
Set with lock 6SR backset=50



	LV BG VBN	OSC OC	AN	AGV	
S1	•	•	•	•	1

A richiesta disponibile kit con 16SR TEKNO - art. CD 813



16SR

specifiche tecniche serrature
a fine capitolo

art. 576

Coppia placche incasso con nottolino 575 e anello di presa

Pair sliding door plates with 575 turn and release with ring grip



576 CP-LV

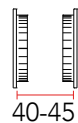
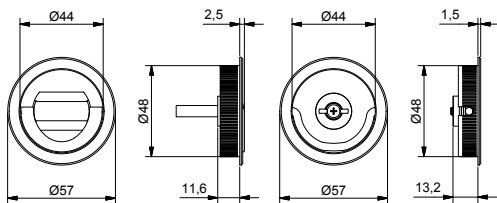

regolabilità standard*

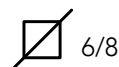

* A richiesta disponibile articolo con ferro per spessori porta da 30 a 39 o da 45 a 49 specificando sempre sull'ordine l'esatto spessore porta.

* on request item available for different door thickness

ART.

576 CP

Coppia placche incasso
Pair sliding door plates



LV
BG

OSC
OC

AN

AGV



•

•

•

•

6

KIT

CD 621-OSC



CD 623-LV

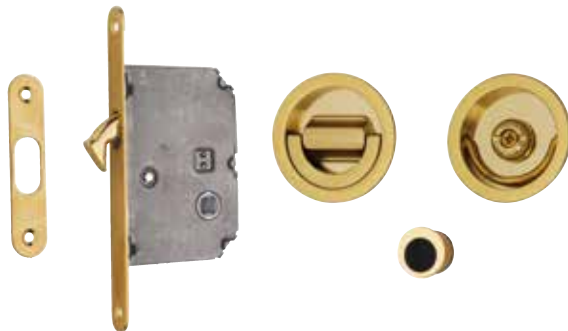

ART.

CD 621

Set con art. 576 CP + art. 525 PI senza serratura
Set with art. 576 CP + art. 525 PI without lock

CD 623

Set con serratura 6SR E=50
Set with lock 6SR backset=50



LV
BG

OSC
OC

AN

AGV



•

•

•

•

1

S1

•

•

•

•

1

A richiesta disponibile kit con 12SR SMART - art. CD 662
A richiesta disponibile kit con 16SR TEKNO - art. CD 807



12SR



16SR

specifiche tecniche serrature
a fine capitolo

art. **576** Coppia placche incasso con nottolino 575 e anello di presa
Pair sliding door plates with 575 turn and release with ring grip



576 CP 00Q-OSC

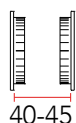
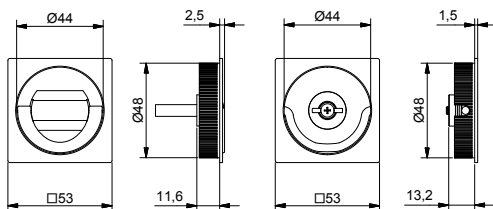

regolabilità standard*



* A richiesta disponibile articolo con ferro per spessori porta da 30 a 39 o da 45 a 49 specificando sempre sull'ordine l'esatto spessore porta.

* on request item available for different door thickness

ART.				LV	OSC OC	
576 CP 00Q	Coppia placche incasso <i>Pair sliding door plates</i>					

KIT

CD 622-OSC



CD 624-OSC



ART.				LV	OSC OC	
CD 622	Set con art. 576 CP 00Q + art. Q25 PI senza serratura <i>Set with art. 576 CP 00Q + art. Q25 PI without lock</i>					
CD 624	Set con serratura 6SR E=50 <i>Set with lock 6SR backset=50</i>		S1	•	•	1

A richiesta disponibile kit con 12SR SMART - art. CD 663
 A richiesta disponibile kit con 16SR TEKNO - art. CD 808



12SR



16SR

specifiche tecniche serrature
a fine capitolo

art. **577** Coppia placche incasso con nottolino 575 da ambo i lati
Pair sliding door plates with 575 turn on both sides



577 CP-LV

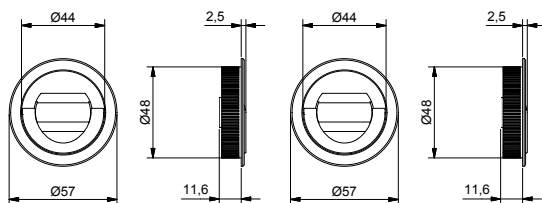

40-47

regolabilità standard*



* A richiesta disponibile articolo con ferro per spessori porta da 30 a 39 o da 45 a 50 specificando sempre sull'ordine l'esatto spessore porta.

* on request item available for different door thickness

ART. 577 CP Coppia placche incasso
Pair sliding door plates



	LV BG	OSC OC	AN	AGV	VBN	
D	•	•	•	•	•	6

KIT

CD 6D1-OSC

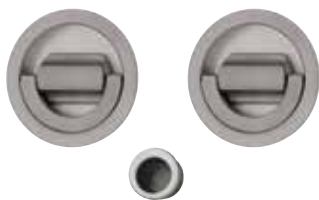

CD 6D4-LV

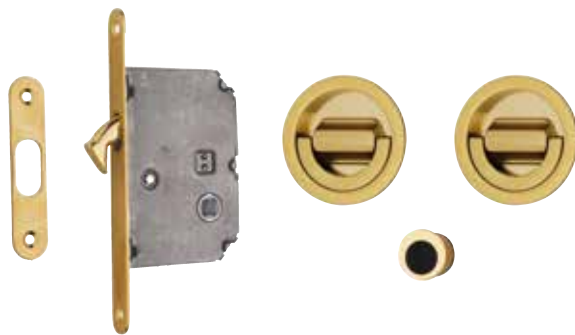

ART. CD 6D1 Set con art. 577 CP + art 525 PI senza serratura
Set with art. 577 CP + art. 525 PI without lock

CD 6D4 Set con serratura 6SR E=50
Set with lock 6SR backset=50



	LV BG	OSC OC	AN	AGV	VBN	
S1	•	•	•	•	•	1

A richiesta disponibile kit con 12SR SMART - art. CD 664
 A richiesta disponibile kit con 16SR TEKNO - art. CD 809



12SR



16SR

specifiche tecniche serrature a fine capitolo

art. **577** Coppia placche incasso con nottolino ad anello da ambo i lati
Pair sliding door plates with 575 turn on both sides



577 CP 00Q-OSC

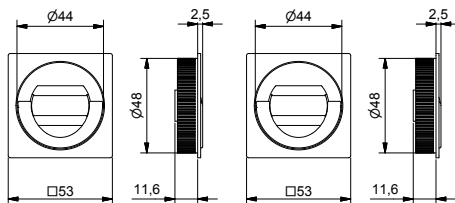

40-47

regolabilità standard*



* A richiesta disponibile articolo con ferro per spessori porta da 30 a 39 o da 45 a 50 specificando sempre sull'ordine l'esatto spessore porta.

* on request item available for different door thickness

ART.

577 CP 00Q

Coppia placche incasso
Pair sliding door plates



LV

OSC
OC



D

•

•

6

KIT

CD 625-OSC



CD 626-OSC



ART.

CD 625

Set con art. 577 CP 00Q + art. Q25 PI senza serratura
Set with art. 577 CP 00Q + art. Q25 PI without lock

CD 626

Set con serratura 6SR E=50
Set with lock 6SR backset=50



LV

OSC
OC



S1

•

•

1

A richiesta disponibile kit con 12SR SMART - art. CD 665
 A richiesta disponibile kit con 16SR TEKNO - art. CD 810



12SR



16SR

specifiche tecniche serrature
 a fine capitolo

art. **578** Coppia placche incasso con nottolino 575 e folle
Pair sliding door plates with 575 turn and roller ring



578 CP-LV

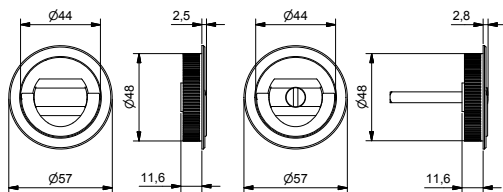
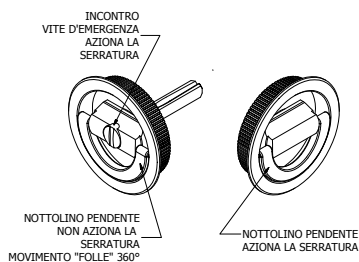

42-46

regolabilità standard*



* A richiesta disponibile articolo con ferro per spessori porta da 30 a 42 o da 46 a 51 specificando sempre sull'ordine l'esatto spessore porta.

* on request item available for different door thickness

ART.

578 CP

Coppia placche incasso
Pair sliding door plates



LV
BG

OSC
OC



KIT

CD 627-LV

CD 666-LV

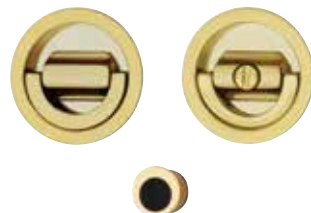
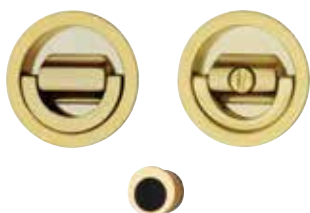

ART.

CD 627

Set con art. 578 CP + art 525 PI senza serratura
Set with art. 578 CP + art. 525 PI without lock

CD 666

Set con serratura 6SR E=50
Set with lock 6SR backset=50

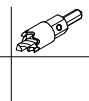

LV
BG

OSC
OC



A richiesta disponibile kit con 16SR TEKNO - art. CD 811



16SR

specifiche tecniche serrature
a fine capitolo

art. **578** Coppia placche incasso con nottolino ad anello e folle
Pair sliding door plates with 575 turn

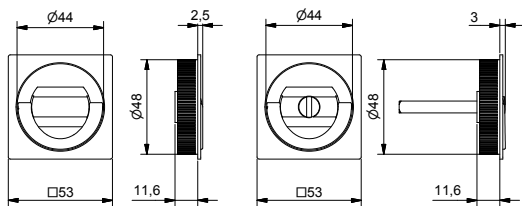

578 CP 00Q-OSC

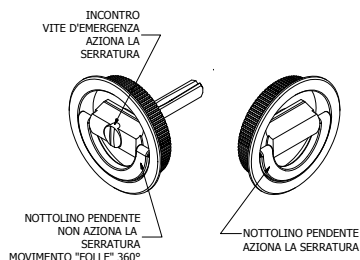

42-46



regolabilità standard*

* A richiesta disponibile articolo con ferro per spessori porta da 30 a 42 o da 46 a 51 specificando sempre sull'ordine l'esatto spessore porta.

* on request item available for different door thickness

ART.

578 CP 00Q

Coppia placche incasso
Pair sliding door plates



LV
•

OSC
OC
•



KIT

CD 628-OSC

CD 667-OSC



ART.

CD 628

Set con art. 578 CP 00Q + art. Q25 PI senza serratura
Set with art. 578 CP 00Q + art. Q25 PI without lock

CD 667

Set con serratura 6SR E=50
Set with lock 6SR backset=50



LV
•

OSC
OC
•



A richiesta disponibile kit con 16SR TEKNO - art. CD 812



16SR

specifiche tecniche serrature
a fine capitolo

art. **508** Coppia placche incasso con nottolino 508
Pair sliding door plates with 508 turn



508 CP-LV

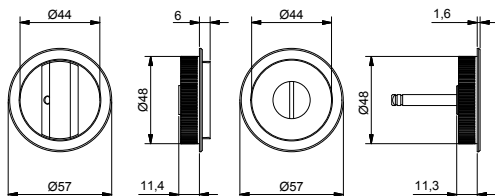

regolabilità standard*



* A richiesta disponibile articolo con ferro per spessori porta da 30 a 39 o da 45 a 52 specificando sempre sull'ordine l'esatto spessore porta.

* On request item available for different door thickness

ART.				LV BG OS	NR OSC OC	AN BGO	AGV	VBN	RX	
508 CP	Coppia placche incasso <i>Pair sliding door plates</i>		G	•	•	•	•	•	•	6

KIT

CD 015-LV

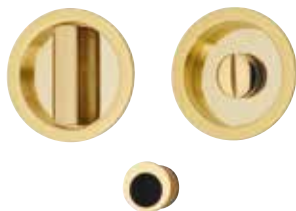

CD 050-OSC



ART.				LV BG OS	NR OSC OC	AN BGO	AGV	VBN	RX	
CD 015	Set con art. 508 CP + art 525 PI senza serratura <i>Set with art. 508 CP + art. 525 PI without lock</i>			•	•	•	•	•	•	1
CD 050	Set con serratura 6SR E=50 <i>Set with lock 6SR backset=50</i>		S1	•	•	•	•	•	•	1

A richiesta disponibile kit con 12SR SMART - art. CD 090
 A richiesta disponibile kit con 16SR TEKNO - art. CD 850



12SR



16SR

specifiche tecniche serrature a fine capitolo

art. **508** Coppia placche incasso con nottolino 508 con libero/occupato
Pair sliding door plates with 508 turn and indicator for wc



508 CP 00F-LV

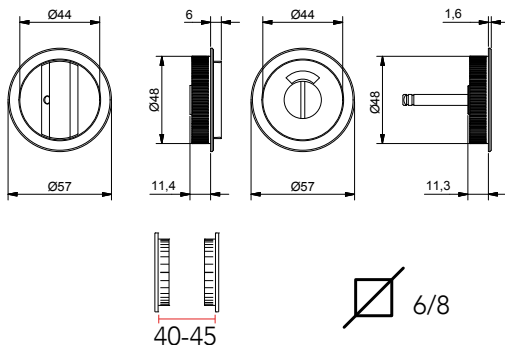

regolabilità standard*

* A richiesta disponibile articolo con ferro per spessori porta da 30 a 39 o da 45 a 52 specificando sempre sull'ordine l'esatto spessore porta.

* on request item available for different door thickness

ART.

508 CP 00F

Coppia placche incasso
Pair sliding door plates

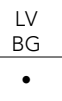

KIT

CD F15-OSC



CD F50-OSC



ART.

CD F15

Set con art. 508 CP 00F + art 525 PI senza serratura
Set with art. 508 CP 00F + art. 525 PI without lock



CD F50

Set con serratura 6SR E=50
Set with lock 6SR backset=50

S1



art. **508** Coppia placche incasso quadre con nottolino 508
 Square pair sliding door plates with 508 turn



508 CP 00Q-OSC

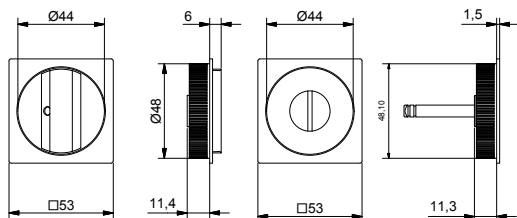

40-45

regolabilità standard*



* A richiesta disponibile articolo con ferro per spessori porta da 30 a 39 o da 45 a 52 specificando sempre sull'ordine l'esatto spessore porta.

* on request item available for different door thickness

ART.

508 CP 00Q

Coppia placche incasso
 Pair sliding door plates



LV

OSC
 OC

SNV

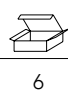

KIT

CD Q15-OSC

CD Q50-OSC



ART.

CD Q15

Set con art. 508 CP 00Q + art Q25 PI senza serratura
 Set with art. 508 CP 00Q + art. Q25 PI without lock



LV

OSC
 OC

SNV



CD Q50

Set con serratura 6SR E=50
 Set with lock 6SR backset=50

S1

•

•

-

1

A richiesta disponibile kit con 12SR SMART - art. CD Q90
 A richiesta disponibile kit con 16SR TEKNO - art. CD Q85



12SR



16SR

specifiche tecniche serrature
 a fine capitolo

art. 538

Coppia placche incasso con nottolino 508 da ambo i lati
Pair sliding door plates with 508 turn on both sides

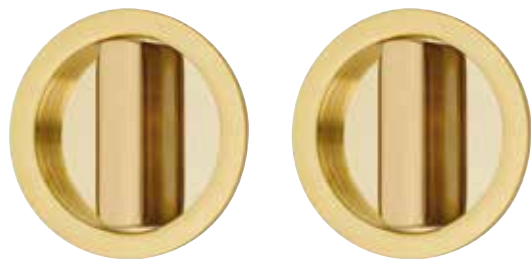

538 CP-LV

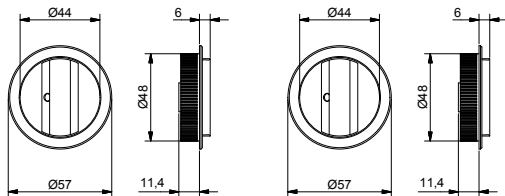

regolabilità standard*



* A richiesta disponibile articolo con ferro per spessori porta da 30 a 39 specificando sempre sull'ordine l'esatto spessore porta.

* on request item available for different door thickness

ART.				LV BG	NR OSC OC	BGO AN	AGV	VBN	
538 CP	Coppia placche incasso <i>Pair sliding door plates</i>		D	•	•	•	•	•	6

KIT

CD D15-LV

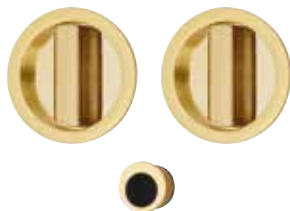

CD D50-LV

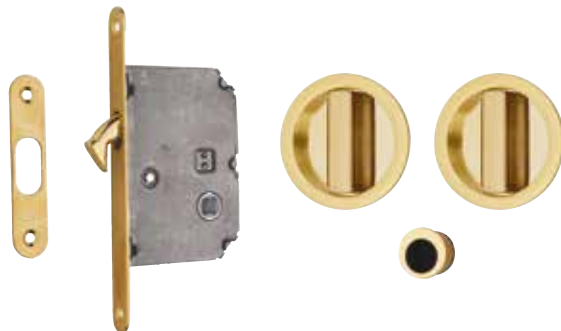

ART.				LV BG	NR OSC OC	BGO AN	AGV	VBN	
CD D15	Set con art. 538 CP + art. 525 PI senza serratura <i>Set with art. 538 CP + art. 525 PI without lock</i>			•	•	•	•	•	1
CD D50	Set con serratura 6SR E=50 <i>Set with lock 6SR backset=50</i>		S1	•	•	•	•	•	1

art. **538** Coppia placche incasso con nottolino 508 da ambo i lati
Pair sliding door plates with 508 turn on both sides



538 CP 00Q-OSC

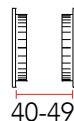
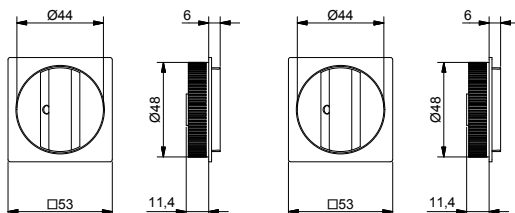

regolabilità standard*

* A richiesta disponibile articolo con ferro per spessori porta da 30 a 39 specificando sempre sull'ordine l'esatto spessore porta.

* on request item available for different door thickness

ART.				LV	OSC OC	SNV	
538 CP 00Q	Coppia placche incasso <i>Pair sliding door plates</i>		D	•	•	•	6

KIT

CD D1Q-OSC

CD D5Q-OSC



ART.				LV	OSC OC	SNV	
CD D1Q	Set con art. 538 CP 00Q + art Q25 PI senza serratura <i>Set with art. 538 CP 00Q + art. Q25 PI without lock</i>			•	•	•	1
CD D5Q	Set con serratura 6SR E=50 <i>Set with lock 6SR backset=50</i>		S1	•	•	-	1

art. 570 Coppia placche incasso con nottolino 519 e folle
 Pair sliding door plates with 519 turn with rolling ring on both sides

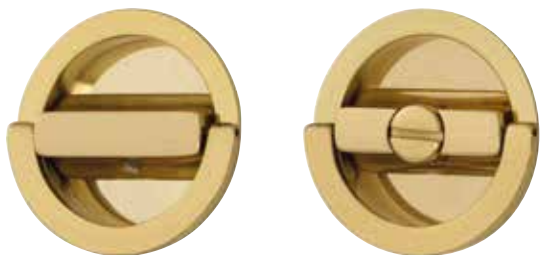

570 CP-LV

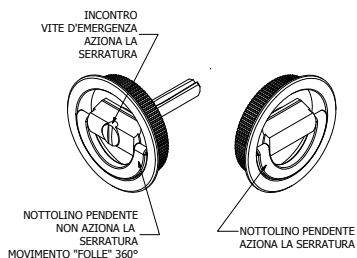
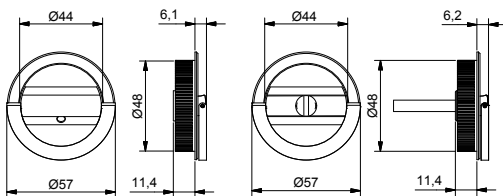

40-46



regolabilità standard*

* A richiesta disponibile articolo con ferro per spessori porta da 30 a 40 o da 46 a 52 specificando sempre sull'ordine l'esatto spessore porta.

* on request item available for different door thickness

ART.

570 CP

Coppia placche incasso
 Pair sliding door plates

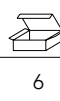
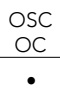
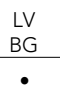

KIT

CD 077-OSC

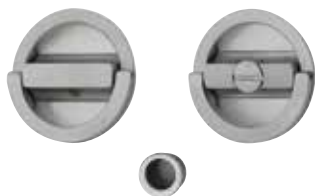

CD 082-LV

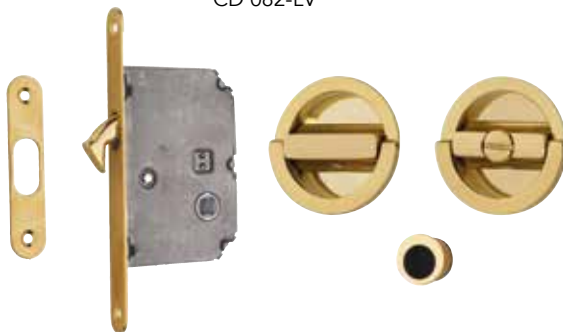

ART.

CD 077

Set con art. 570 CP + art 525 PI senza serratura
 Set with art. 570 CP + art. 525 PI without lock

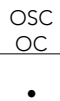
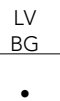

CD 082

Set con serratura 6SR E=50
 Set with lock 6SR backset=50



S1

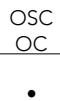
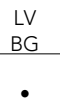

A richiesta disponibile kit con 12SR SMART - art. CD 096



12SR

specifiche tecniche serrature
 a fine capitolo

art. 519

Coppia placche incasso con nottolino 519 ad anello

Pair sliding door plates with 519 turn with ring

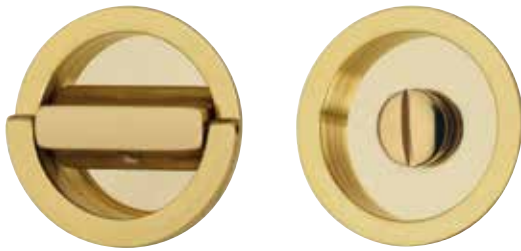

519 CP-LV

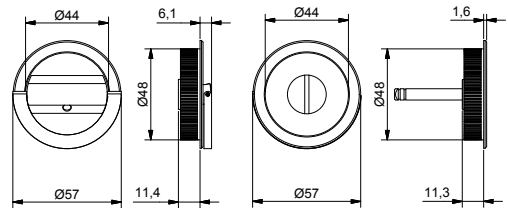

regolabilità standard*



* A richiesta disponibile articolo con ferro per spessori porta da 30 a 39 o da 45 a 52 specificando sempre sull'ordine l'esatto spessore porta.

* on request item available for different door thickness

ART.				LV BG	OSC OC	AN	AGV	VBN	
519 CP	Coppia placche incasso Pair sliding door plates		G	•	•	•	•	•	6

KIT

CD 031-LV

CD 044-OSC

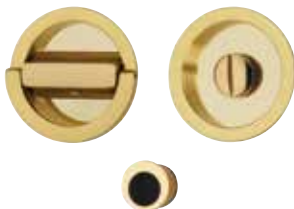

ART.				LV BG	OSC OC	AN	AGV	VBN	
CD 031	Set con art. 519 CP + art 525 PI senza serratura Set with art. 519 CP + art. 525 PI without lock			•	•	•	•	•	1
CD 044	Set con serratura 6SR E=50 Set with lock 6SR backset=50		S1	•	•	•	•	•	1

A richiesta disponibile kit con 12SR SMART - art. CD 092
A richiesta disponibile kit con 16SR TEKNO - art. CD 822



12SR



16SR

specifiche tecniche serrature
a fine capitolo

art. 519 Coppia placche incasso con nottolino ad anello con libero/occupato
 Pair sliding door plates with turn with ring and indicator for wc



519 CP 00F-LV

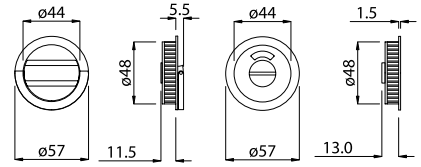

OSC



ART.

519 CP 00F

Coppia placche incasso
 Pair sliding door plates



LV
 BG

OSC
 OC



KIT

CD F31-LV

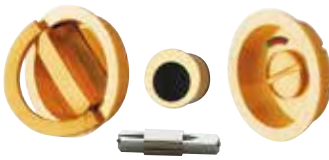

CD F44-LV



ART.

CD F31

Set con art. 519 CP 00F + art 525 PI senza serratura
 Set with art. 519 CP 00F + art. 525 PI without lock



LV
 BG

OSC
 OC



CD F44

Set con serratura 6SR E=50
 Set with lock 6SR backset=50

S1

LV
 BG

OSC
 OC



art. 542 Coppia placche incasso con nottolino ad anello ed incontro con anello di presa
 Pair sliding door plates with turn with ring and release with ring grip

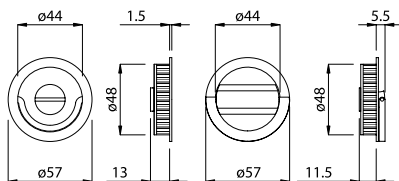

542 CP-LV



40-45

regolabilità standard*

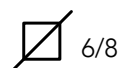

OC

OSC

* A richiesta disponibile articolo con ferro per spessori porta da 30 a 39 o da 45 a 52 specificando sempre sull'ordine l'esatto spessore porta.

* on request item available for different door thickness

ART.

542 CP

Coppia placche incasso
 Pair sliding door plates

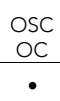
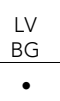

KIT

CD 043-LV



CD 045-LV



ART.

CD 043

Set con art. 542 CP + art 525 PI senza serratura
 Set with art. 519 CP 00F + art. 525 PI without lock

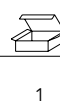
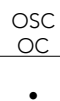
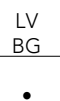
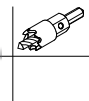

CD 045

Set con serratura 6SR E=50
 Set with lock 6SR backset=50

S1



art. 518 Coppia placche incasso con nottolino ad anello e bordo di presa
 Pair sliding door plates with turn with ring and rim grip



518 CP-LV

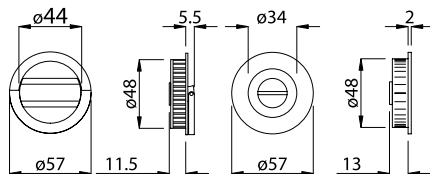

ART.				LV	OSC	
518 CP	Coppia placche incasso Pair sliding door plates			BG	OC	
		G	•	•		

art. 540 Coppia placche incasso quadrate con nottolino 519 da ambo le parti
 Square pair sliding door plates with 519 turn with ring on both sides



540 CP 00Q-LV

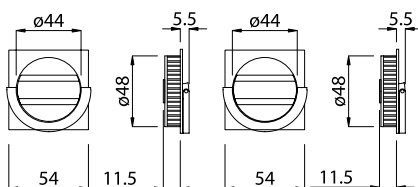

OSC

OC



ART.				LV	OSC	
540 CP 00Q	Coppia placche incasso Pair sliding door plates			•	•	
		D	•	•		

KIT

ART.				LV	OSC	
CD D3Q •	Set con art. 540 CP 00Q + art. Q25 PI senza serratura Set with art. 540 CP 00Q + art. Q25 PI without lock			•	•	
CD D4Q *	Set con serratura 6SR E=50 Set with lock 6SR backset=50	S1	•	•	1	



CON SERRATURA
WITH LOCK

art. 540

Coppia placche incasso con nottolino 519 da ambo i lati

Pair sliding door plates with 519 turn on both sides

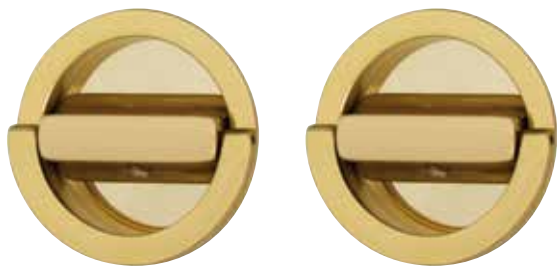

540 CP-LV

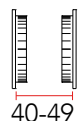
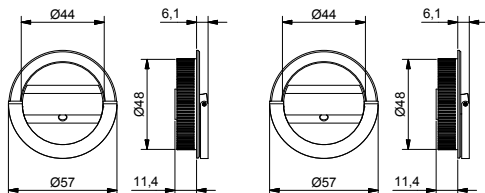

regolabilità standard*



* A richiesta disponibile articolo con ferro per spessori porta da 30 a 39 specificando sempre sull'ordine l'esatto spessore porta.

* on request item available for different door thickness

ART.

540 CP

Coppia placche incasso
Pair sliding door plates



LV
BG

OSC
OC

AN

AGV

VBN



D

•

•

•

•

•

6

KIT

CD D31-LV

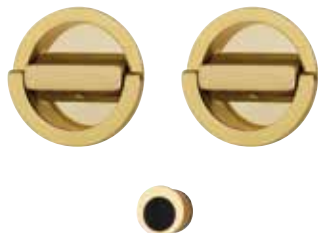

CD D44-OSC



ART.

CD D31

Set con art. 540 CP + art 525 PI senza serratura
Set with art. 540 CP + art. 525 PI without lock

CD D44

Set con serratura 6SR E=50
Set with lock 6SR backset=50



LV
BG

OSC
OC

AN

AGV

VBN



S1

•

•

•

•

•

1

A richiesta disponibile kit con 12SR SMART - art. CD D92
A richiesta disponibile kit con 16SR TEKNO - art. CD 831



12SR



16SR

specifiche tecniche serrature
a fine capitolo

art. 559

Coppia placche incasso con nottolino FAST

Pair sliding door plates with FAST turn

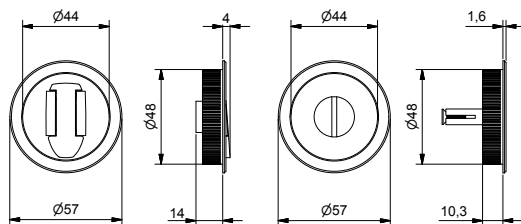
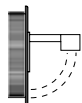

559 CP-LV

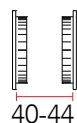

regolabilità standard*



* A richiesta disponibile articolo con ferro per spessori porta da 30 a 39 o da 45 a 53 specificando sempre sull'ordine l'esatto spessore porta.

* on request item available for different door thickness

ART.

559 CP

Coppia placche incasso
Pair sliding door plates

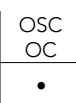
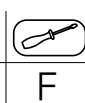

KIT

CD 016-LV

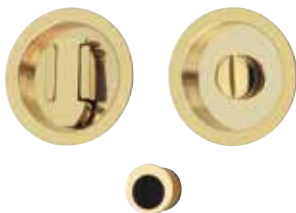

CD 051-LV

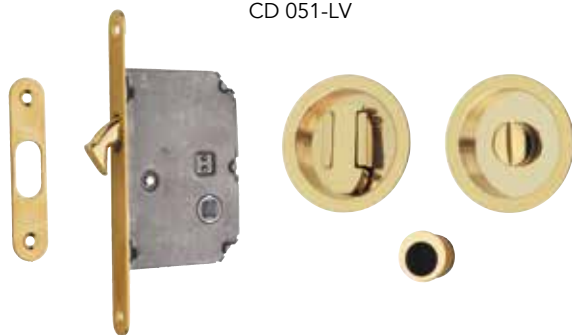

ART.

CD 016

Set con art. 559 CP + art 525 PI senza serratura
Set with art. 559 CP + art. 525 PI without lock

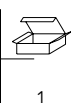
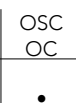
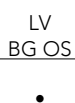

CD 051

Set con serratura 6SR E=50
Set with lock 6SR backset=50

S1



A richiesta disponibile kit con 12SR SMART - art. CD 091
A richiesta disponibile kit con 16SR TEKNO - art. CD 851



12SR



16SR

specifiche tecniche serrature
a fine capitolo

art. 559

Coppia placche incasso con nottolino FAST con libero/occupato
 Pair sliding door plates with FAST turn and indicator for wc



BREVETTATO/PATENTED

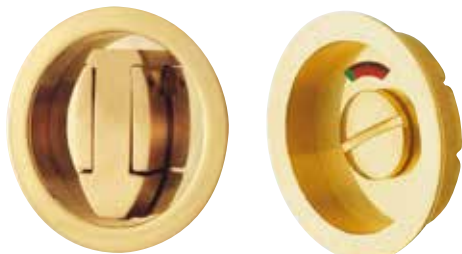
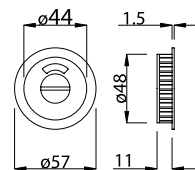
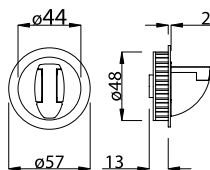

559 CP 00F-LV



OC



OSC

ART.
559 CP 00F

Coppia placche incasso
 Pair sliding door plates



LV BG OS
•

OSC OC
•

6

KIT

CD F16 -LV



CD F51-LV



ART.

CD F16

Set con art. 559 CP 00F + art 525 PI senza serratura
 Set with art. 559 CP + art. 525 PI without lock



LV BG OS
•

OSC OC
•

1

CD F51

Set con serratura 6SR E=50
 Set with lock 6SR backset=50

S1

•

•

1

art. 559 Coppia placche incasso con nottolino FAST

Pair sliding door plates with internal FAST turn

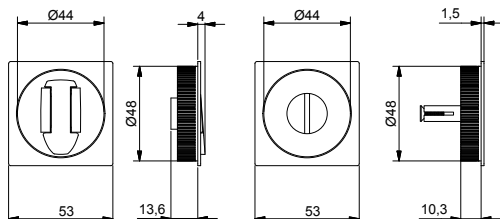
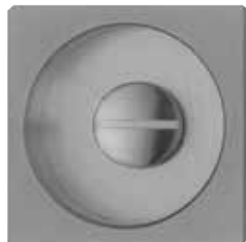
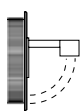

regolabilità standard*

559 CP 00Q-OSC

* A richiesta disponibile articolo con ferro per spessori porta da 30 a 39 o da 45 a 53 specificando sempre sull'ordine l'esatto spessore porta.

* on request item available for different door thickness

ART.

559 CP 00Q

Coppia placche incasso
Pair sliding door plates



	LV	OSC OC	
F	•	•	6

KIT

CD Q16-OSC

CD Q51-OSC



ART.

CD Q16

Set con art. 559 CP 00Q + art. Q25 PI senza serratura
Set with art. 559 CP 00Q + art. Q25 PI without lock

CD Q51

Set con serratura 6SR E=50
Set with lock 6SR backset=50



	LV	OSC OC	
S1	•	•	1

A richiesta disponibile kit con 12SR SMART - art. CD Q91



12SR

specifiche tecniche serrature
a fine capitolo

art. 560 Coppia placche incasso con nottolino FAST da ambo i lati
 Pair sliding door plates with FAST turn on both sides

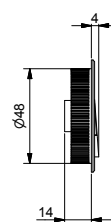
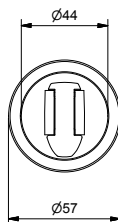
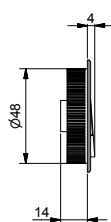
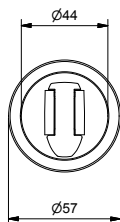
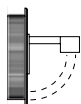

560 CP-LV

40-52
 regolabilità standard*



* on request item available for different door thickness

ART.				LV BG	OSC OC	
560 CP	Coppia placche incasso Pair sliding door plates	F	•	•	6	

KIT

CD D16-LV

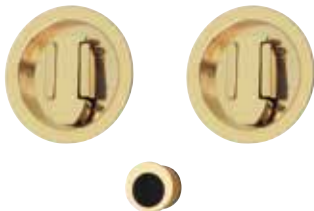

CD D51-LV

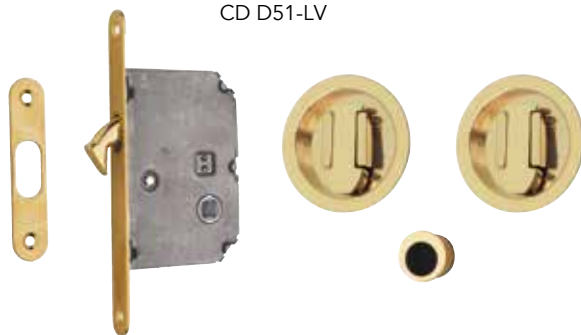

ART.				LV BG	OSC OC	
CD D16	Set con art. 560 CP + art 525 PI senza serratura Set with art. 560 CP + art. 525 PI without lock	•	•	•	1	
CD D51	Set con serratura 6SR E=50 Set with lock 6SR backset=50	S1	•	•	1	

A richiesta disponibile kit con 12SR SMART - art. CD D91



12SR

specifiche tecniche serrature
 a fine capitolo

art. **560** Coppia placche incasso con nottolino FAST da ambo i lati
Pair sliding door plates with internal FAST turn on both sides

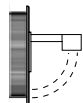

560 CP 00Q-OSC

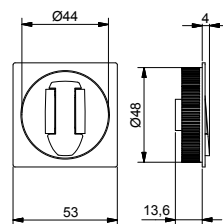
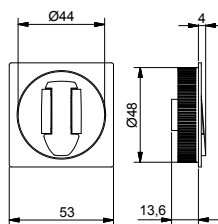

40-52

regolabilità standard



ART.

560 CP 00Q

Coppia placche incasso
Pair sliding door plates

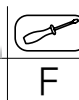

LV

OSC
 OC



6

KIT

CD QD6-OSC

CD QD1-OSC



ART.

CD QD6

Set con art. 560 CP 00Q + art. Q25 PI senza serratura
Set with art. 560 CP 00Q + art. Q25 PI without lock

CD QD1

Set con serratura 6SR E=50
Set with lock 6SR backset=50



LV

OSC
 OC



1

1

A richiesta disponibile kit con 12SR SMART - art. CD QD9



12SR

specifiche tecniche serrature
 a fine capitolo

art. 808

Coppia placche incasso in **acciaio stampato** con nottolino 873
 Pair sliding door plates **stamped steel** with 873 turn

TeKnoMetal
 Linea in zama



808 CP-OTT. BRILL

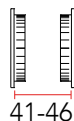
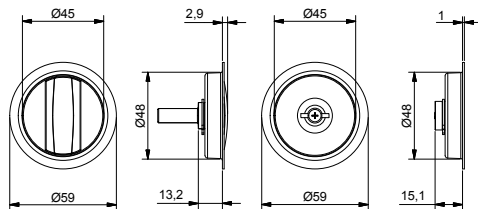

41-46

regolabilità standard*



* A richiesta disponibile articolo con ferro per spessori porta da 46 a 50 specificando sempre sull'ordine l'esatto spessore porta.

* on request item available for different door thickness

ART.

808 CP

Coppia placche incasso
 Pair sliding door plates

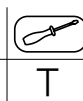

OTT.
BRILL
•

ZSC
ZCR
•

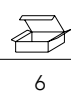

KIT

CD 815-ZSC



CD 876-OTT.BRILL



ART.

CD 815

Set con art. 808 CP + art 525 PI senza serratura
 Set with art. 808 CP + art. 525 PI without lock



OTT.
BRILL
•

ZSC
ZCR
•



CD 876

Set con serratura TEKNO 16SR E=50
 Set with lock TEKNO 16SR backset=50

S1

•

•



A richiesta disponibile kit con 12SR SMART - art. CD 765
 A richiesta disponibile kit con 6SR - art. CD 076



12SR



6SR

specifiche tecniche serrature
 a fine capitolo

art. **875** Coppia placche incasso in **acciaio stampato** con nottolino ad anello
 Pair sliding door plates **stamped steel** with 575 flush pull ring



875 CP-LV

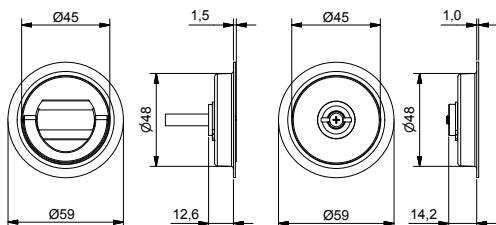

40-45

regolabilità standard*



* A richiesta disponibile articolo con ferro per spessori porta da 45 a 49 specificando sempre sull'ordine l'esatto spessore porta.

* on request item available for different door thickness

ART.				LV	OSC OC	
875 CP	Coppia placche incasso Pair sliding door plates		T	•	•	6

KIT

CD 640-LV

CD 824-LV



ART.				LV	OSC OC	
CD 640	Set con art. 875 CP + art 525 PI senza serratura Set with art. 875 CP + art. 525 PI without lock			•	•	1
CD 824	Set con serratura TEKNO 16SR E=50 Set with lock TEKNO 16SR backset=50		S1	•	•	1

A richiesta disponibile kit con 6SR - art. CD 683



6SR

specifiche tecniche serrature
a fine capitolo

art. **877** Coppia placche incasso in **acciaio stampato** con nottolino ad anello ambo i lati
Pair sliding door plates stamped steel with 575 turn on both sides



877 CP-LV

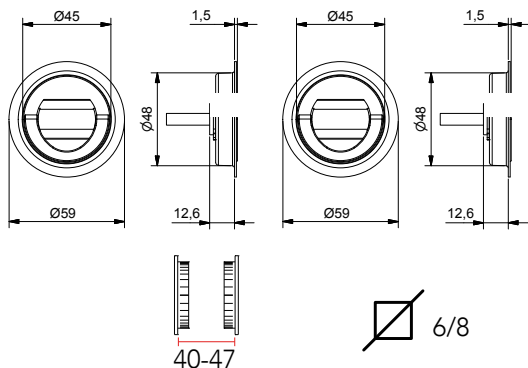

regolabilità standard*

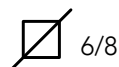

* A richiesta disponibile articolo con ferro per spessori porta da 47 a 50 specificando sempre sull'ordine l'esatto spessore porta.

* on request item available for different door thickness

ART.

877 CP

Coppia placche incasso
Pair sliding door plates



LV

OSC
 OC



6

KIT

CD 641-LV



CD 825-LV



ART.

CD 641

Set con art. 877 CP + art 525 PI senza serratura
Set with art. 877 CP + art. 525 PI without lock



LV

OSC
 OC



1

CD 825

Set con serratura TEKNO 16SR E=50
Set with lock TEKNO 16SR backset=50

S1

1

A richiesta disponibile kit con 6SR - art. CD 684



6SR

specifiche tecniche serrature
 a fine capitolo

art. **506** Coppia placche incasso con nottolino 503
 Pair sliding door plates with 503 turn



506 CP-LV

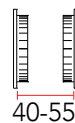
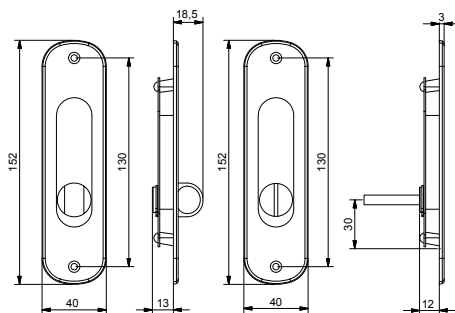

regolabilità standard

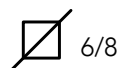

ART.
506 CP 00A

Coppia placche incasso
Pair sliding door plates



	LV BG	OSC OC	AN BGO	AGV	VBN	
P	•	•	•	•	•	4

KIT

CD 017-AN



CD 054-LV

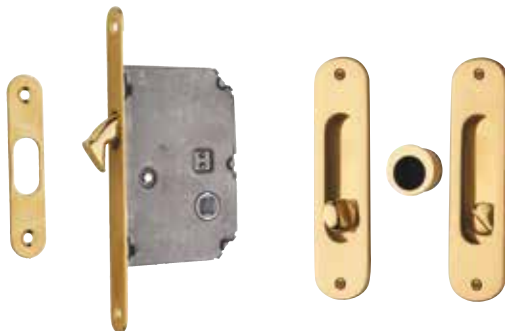

ART.



CD 017 Set con art. 506 CP 00A+ art 525 PI senza serratura
Set with art. 506 CP 00A+ art. 525 PI without lock

CD 054 Set con serratura 6SR E=50
Set with lock 6SR backset=50

	LV BG	OSC OC	AN	AGV	VBN	
S2	•	•	•	•	•	1

art. 556

Coppia placche incasso con nottolino 503 ambo le parti
Pair sliding door plates with 503 turn on both sides



556 CP-LV

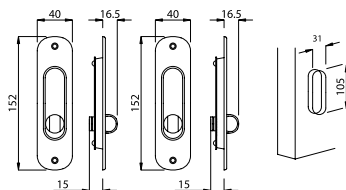

OSC



AN



AGV

ART.

556 CP

Coppia placche incasso
Pair sliding door plates



	LV BG OS	OC OSC	AN	AGV	
P	•	•	•	•	4

KIT

CD D17-LV



CD D54-OSC



CD D54-LV

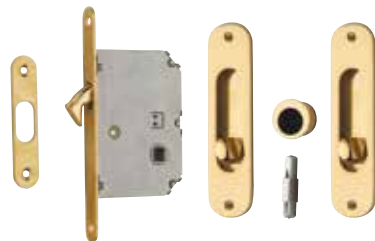

ART.

CD D17

Set con art. 556 CP + art 525 PI senza serratura
Set with art. 556 CP + art. 525 PI without lock

CD D54

Set con serratura TEKNO 16SR E=50
Set with lock TEKNO 16SR backset=50



	LV BG	OSC OC	
	•	•	1
S2	•	•	1

art. 514

Coppia placche incasso con nottolino pendente 514
 Pair sliding door plates with 514 pendent turn



514 CP-LV

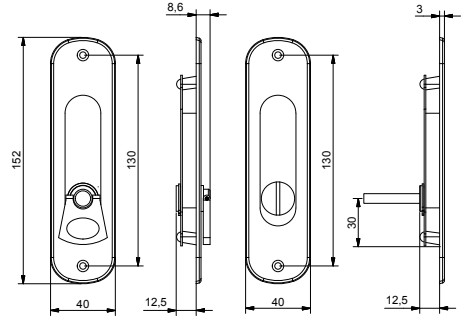

regolabilità standard



ART.

514 CP

Coppia placche incasso
 Pair sliding door plates

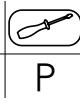

LV
BG

OSC
OC

AN

AGV

RX

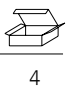

P

•

•

•

•

•

4

KIT

CD 032-LV

CD 046-LV



ART.

CD 032

Set con art. 514 CP + art 525 PI senza serratura
 Set with art. 514 CP + art. 525 PI without lock



LV
BG

OSC
OC

AN

AGV

RX



S2

•

•

•

•

•

1

CD 046

Set con serratura 6SR E=50
 Set with lock 6SR backset=50

art. 544

Coppia placche incasso con nottolino pendente 514 da ambo i lati
 Pair sliding door plates with 514 pendent turn on both sides



544 CP-OC

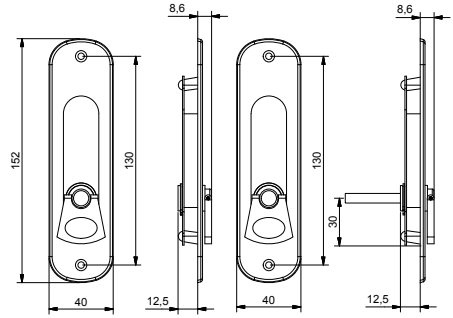

40-50

regolabilità standard



ART.

544 CP

Coppia placche incasso
 Pair sliding door plates

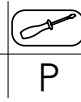

P

LV
BG

OSC
OC

AN

AGV

RX

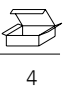

4

KIT

CD D32-LV



CD D46-LV



ART.

CD D32

Set con art. 544 CP + art 525 PI senza serratura
 Set with art. 544 CP + art. 525 PI without lock



S2

LV
BG

OSC
OC

AN

AGV

RX



1

CD D46

Set con serratura 6SR E=50
 Set with lock 6SR backset=50

1

art. 554 Coppia placche incasso con nottolino pendente basso a filo
 Pair sliding door plates with low pendent turn



554 CP-LV

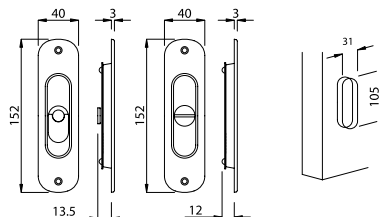

OSC



OC

ART.

554 CP

Coppia placche incasso
 Pair sliding door plates



LV
BG

OC
OSC



P

•

•

4

KIT

CD 078-OSC

CD 079-OSC

CD 079-LV



ART.

CD 078

Set con art. 554 CP + art 525 PI senza serratura
 Set with art. 554 CP + art. 525 PI without lock

CD 079

Set con serratura 6SR E=50
 Set with lock 6SR backset=50



LV
BG

OC
OSC



S5

•

•

1

art. 504 Coppia placche incasso con nottolino 503
 Pair sliding door plates with 503 turn



504 CP 00A-LV

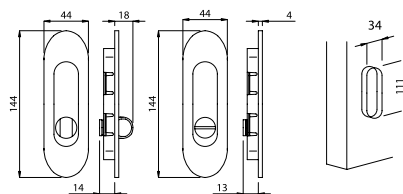

OC



OSC



BG

ART.

504 CP

Coppia placche incasso
 Pair sliding door plates



	LV BG	OC OSC	
P	•	•	4

KIT

CD 018-LV



CD 058-LV

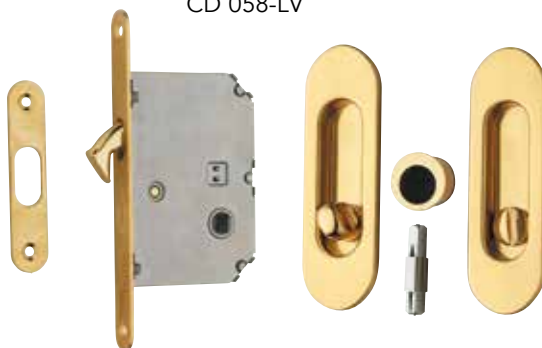

ART.

CD 018

Set con art. 504 CP + art 525 PI senza serratura
 Set with art. 504 CP + art. 525 PI without lock

CD 058

Set con serratura 6SR E=50
 Set with lock 6SR backset=50



	LV BG	OC OSC	
S3	•	•	1

art. 553 Coppia placche incasso con nottolino 503 da ambo i lati
 Pair sliding door plates with 503 turn on both sides



553 CP-LV

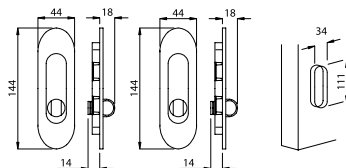

BG



OSC

ART.

553 CP

Coppia placche incasso
 Pair sliding door plates



	LV - BG OS	OC OSC	
P	•	•	4

KIT

CD D18-LV

CD D58-OSC

CD D58-LV

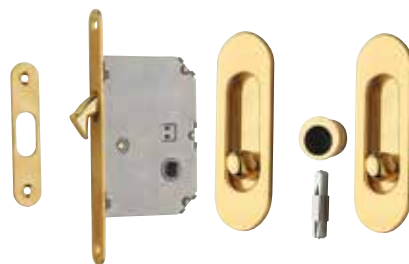

ART.

CD D18

Set con art. 553 CP + art 525 PI senza serratura
 Set with art. 553 CP + art. 525 PI without lock

CD D58

Set con serratura 6SR E=50
 Set with lock 6SR backset=50



	LV - BG OS	OC OSC	
S3	•	•	1

art. 515

Coppia placche incasso coprivite con nottolino pendente 514
 Pair cover screw sliding door plates with 514 pendent turn



515 CP-LV

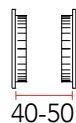
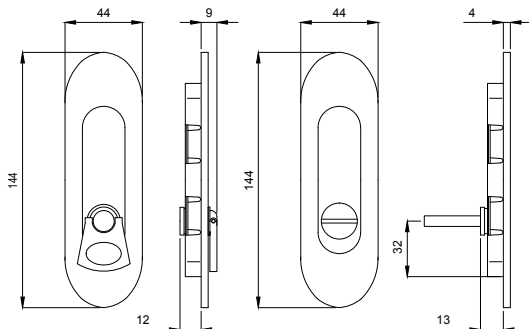

regolabilità standard



ART.

515 CP

Coppia placche incasso
 Pair sliding door plates

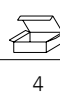
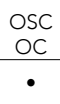
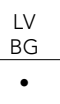
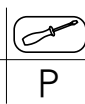

KIT

CD 033-OC



CD 048-LV

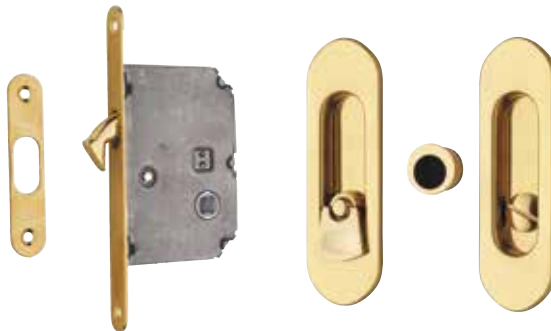

ART.

CD 033

Set con art. 515 CP + art 525 PI senza serratura
 Set with art. 515 CP + art. 525 PI without lock

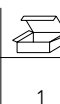
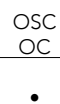
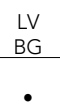

CD 048

Set con serratura 6SR E=50
 Set with lock 6SR backset=50

S3



art. 545 Coppia placche incasso coprivite con nottolino pendente 514 da ambo i lati
 Pair cover screw sliding door plates with 514 pendent turn on both sides



545 CP-LV

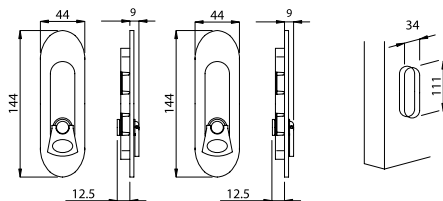

OC



OSC





BG

ART.

545 CP

Coppia placche incasso
 Pair sliding door plates



	LV - BG OS	OSC OC	
P	•	•	4

KIT

CD D33-LV



CD D48-LV



ART.



CD D33

Set con art. 545 CP + art 525 PI senza serratura
 Set with art. 545 CP + art. 525 PI without lock

CD D48

Set con serratura 6SR E=50
 Set with lock 6SR backset=50



	LV - BG OS	OSC OC	
S3	•	•	1

art. 555

Coppia placche incasso coprivite con nottolino pendente basso a filo
 Pair cover screw sliding door plates with low pendent turn



555 CP-LV

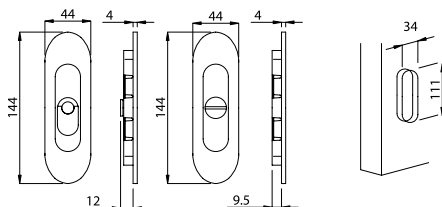

OC



OSC

ART.

555 CP

Coppia placche incasso
 Pair sliding door plates

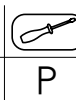

LV
 BG

OSC
 OC

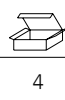

KIT

CD 080-OSC



CD 081-OSC



ART.

CD 080

Set con art. 555 CP + art 525 PI senza serratura
 Set with art. 555 CP + art. 525 PI without lock



LV
 BG

OSC
 OC

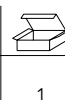

CD 081

Set con serratura 6SR E=50
 Set with lock 6SR backset=50

S6

•

•



art. 535 Coppia placche incasso coprivite con nottolino 503 in centro
 Pair cover screw sliding door plates with 503 turn



535 CP C00-LV



OC

OSC

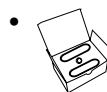
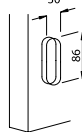
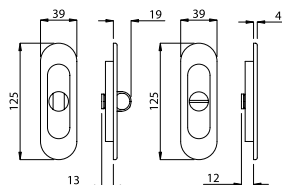

CON SERRATURA
WITH LOCK

ART.				LV BG	OSC OC	
535 CP C00	Coppia placche incasso Pair sliding door plates		P	•	•	4
CD 057 •	Set con art. 535 CP C00 + art 525 PI senza serratura Set with art. 535 CP C00 + art. 525 PI without lock			LV BG	OSC OC	
CD 069 *	Set con serratura 6SR E=50 Set with lock 6SR backset=50		S4	•	•	1

art. 535 Coppia placche incasso coprivite con nottolino 503 in basso
 Pair cover screw sliding door plates with 503 turn



535 CP B00-LV



OC

OSC

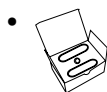
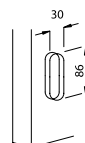
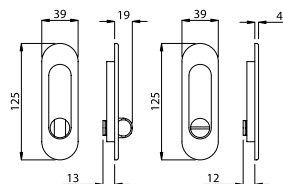

CON SERRATURA
WITH LOCK

ART.				LV BG	OSC OC	
535 CP B00	Coppia placche incasso Pair sliding door plates		P	•	•	4
CD 028 •	Set con art. 535 CP B00 + art 525 PI senza serratura Set with art. 535 CP B00 + art. 525 PI without lock			LV BG	OSC OC	
CD 062 *	Set con serratura 6SR E=50 Set with lock 6SR backset=50		S7	•	•	1

art. 536

Coppia placche incasso coprivite con nottolino 503 da ambo i lati in centro
Pair cover screw sliding door plates with 503 turn on both sides



536 CP C00-LV



OSC

OC

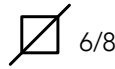
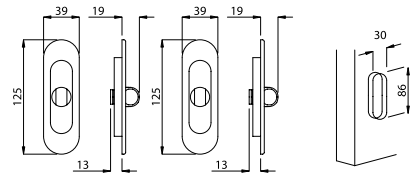

6/8

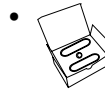

CON SERRATURA
WITH LOCK

ART.

536 CP C00

Coppia placche incasso
Pair sliding door plates



LV
BG

OSC
OC



P

•

•

4

ART.

CD D57 •

Set con art. 536 CP C00 + art. 525 PI senza serratura
Set with art. 536 CP C00 + art. 525 PI without lock

CD D69 *

Set con serratura 6SR E=50
Set with lock 6SR backset=50



LV
BG

OSC
OC



S4

•

.

1

art. 536

Coppia placche incasso coprivite con nottolino 503 da ambo i lati in basso
Pair cover screw sliding door plates with 503 on both sides

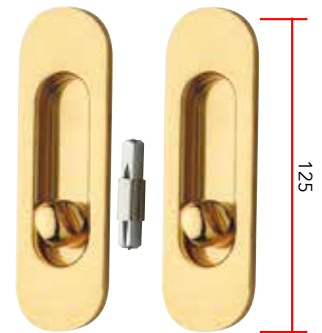

536 CP B00-LV



OSC

BG

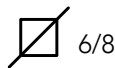
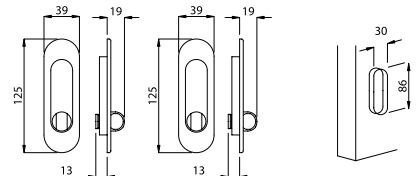

6/8

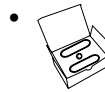

CON SERRATURA
WITH LOCK

ART.

536 CP B00

Coppia placche incasso
Pair sliding door plates



LV
BG

OSC
OC



P

•

•

4

ART.

CD D28 •

Set con art. 536 CP B00 + art. 525 PI senza serratura
Set with art. 536 CP B00 + art. 525 PI without lock

CD D62 *

Set con serratura 6SR E=50
Set with lock 6SR backset=50



LV
BG

OSC
OC



S7

•

.

1

art. **552** Coppia placche incasso coprivite con nottolino pendente 555
Pair cover screw sliding door plates with 555 pendent turn



552 CP-LV

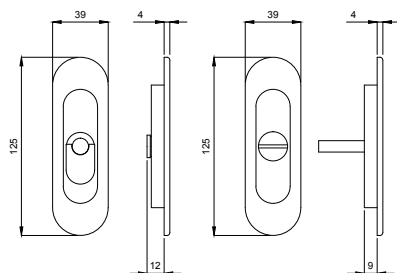

40-45

regolabilità standard*



* A richiesta disponibile articolo con ferro per spessori porta da 35 a 40 e da 45 a 50 specificando sempre sull'ordine l'esatto spessore porta.

* on request item available for different door thickness

ART.

552 CP

Coppia placche incasso
Pair sliding door plates

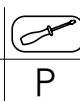

LV
BG

OSC
OC

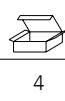

4

KIT

CD 037-OSC



CD 068-LV



ART.

CD 037

Set con art. 552 CP + art 525 PI senza serratura
Set with art. 552 CP + art. 525 PI without lock

CD 068

Set con serratura 6SR E=50
Set with lock 6SR backset=50



LV
BG

OSC
OC

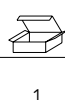

1

S4

1

A richiesta disponibile kit con 12SR TEKNO - art. CD 685



12SR

specifiche tecniche serrature
a fine capitolo

art. 952 Coppia placche incasso coprivite con nottolino pendente 555
 Pair cover screw sliding door plates with 555 pendent turn



952 CP-OSC

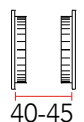
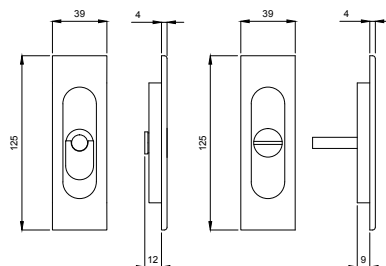

regolabilità standard*



* A richiesta disponibile articolo con ferro per spessori porta da 35 a 40 e da 45 a 50 specificando sempre sull'ordine l'esatto spessore porta.

* on request item available for different door thickness

ART.

952 CP

Coppia placche incasso
 Pair sliding door plates

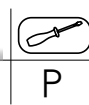

LV
•

OSC
OC
•

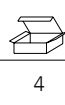

KIT

CD 937-OSC



CD 968-OSC



ART.

CD 937

Set con art. 952 CP + art. Q25 PI senza serratura
 Set with art. 952 CP + art. Q25 PI without lock

CD 968

Set con serratura 6SR E=50
 Set with lock 6SR backset=50

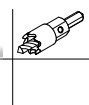

LV
•

OSC
OC
•

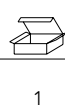

A richiesta disponibile kit con 12SR SMART - art. CD 96S



12SR

specifiche tecniche serrature
 a fine capitolo

art. **935** Coppia placche incasso coprivite con nottolino 503 in centro
Pair sliding door plates with 503 turn



935 CP C00-OSC

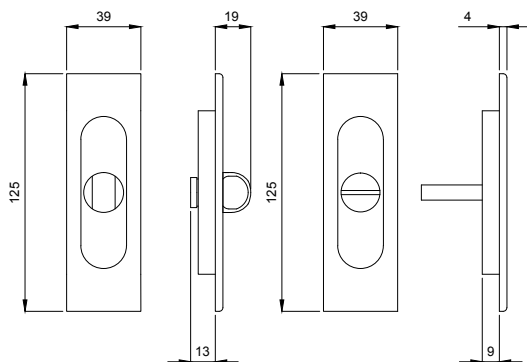

regolabilità standard



ART.
935 CP C00

Coppia placche incasso
Pair sliding door plates

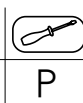

LV
•

OSC
•

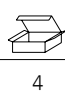

KIT

CD 957-OSC



CD 969-OSC



ART.

CD 957

Set con art. 935 CP C00 + art. Q25 PI senza serratura
Set with art. 935 CP C00 + art. Q25 PI without lock

CD 969

Set con serratura 6SR E=50
Set with lock 6SR backset=50



LV
•

OSC
•

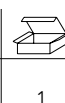

art. **935** Coppia placche incasso coprivite con nottolino 503 in basso
Pair sliding door plates with 503 turn



935 CP B00-OSC

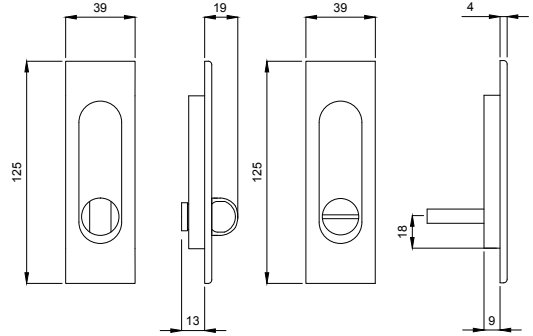

40-55
regolabilità standard



ART.

935 CP B00

Coppia placche incasso
Pair sliding door plates

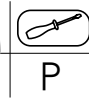

LV
•

OSC
OC
•

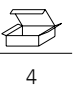

KIT

CD 928-OSC



CD 962-OSC



ART.

CD 928

Set con art. 935 CP B00 + art. Q25 PI senza serratura
Set with art. 935 CP B00 + art. Q25 PI without lock

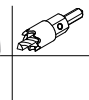

LV
•

OSC
OC
•

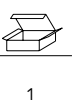

CD 962

Set con serratura 6SR E=50
Set with lock 6SR backset=50

A richiesta disponibile kit con 12SR SMART - art. CD 925



12SR

specifiche tecniche serrature
a fine capitolo

art. 950

Coppia placche incasso coprivite con nottolino 514 in centro
 Pair sliding door plate with 514 turn



950 CP C00-OSC

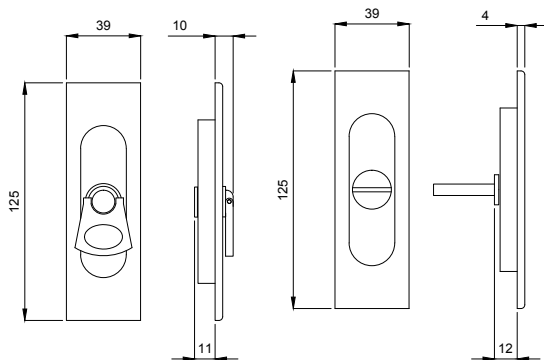

40-50
 regolabilità standard



ART.
 950 CP C00

Coppia placche incasso
 Pair sliding door plates



	LV	OSC OC	
P	•	•	4

KIT

CD 919-OSC



CD 960-OSC



ART.
 CD 919

Set con art. 950 CP C00 + art Q25 PI senza serratura
 Set with art. 950 CP C00 + art. Q25 PI without lock



	LV	OSC OC	
	•	•	1
S4	•	•	1

CD 960

Set con serratura 6SR E=50
 Set with lock 6SR backset=50

art. 951

Coppia placche incasso coprivite con nottolini 514 in centro
 Pair sliding door plate with 514 pendent turn on both sides



951 CP C00-OSC

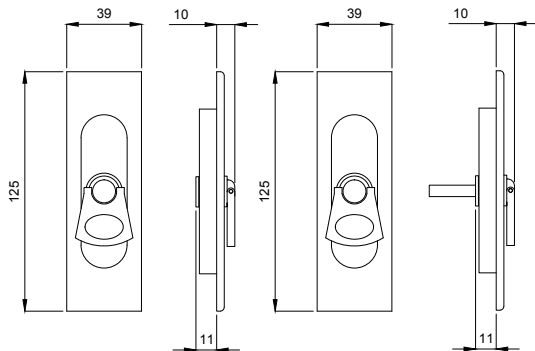

regolabilità standard



ART.

951 CP C00

Coppia placche incasso
 Pair sliding door plates



	LV	OSC OC	
P	•	•	4

KIT

CD 19D-OSC



CD 60D-OSC



ART.

CD 19D

Set con art. 951 CP C00 + art. Q25 PI senza serratura
 Set with art. 951 CP C00 + art. Q25 PI without lock

CD 60D

Set con serratura 6SR E=50
 Set with lock 6SR backset=50



	LV	OSC OC	
S4	•	•	1

art. 914 Coppia placche incasso con nottolino pendente 514

Pair sliding door plates with 514 pendent turn

40-50
regolabilità standard*

6/8

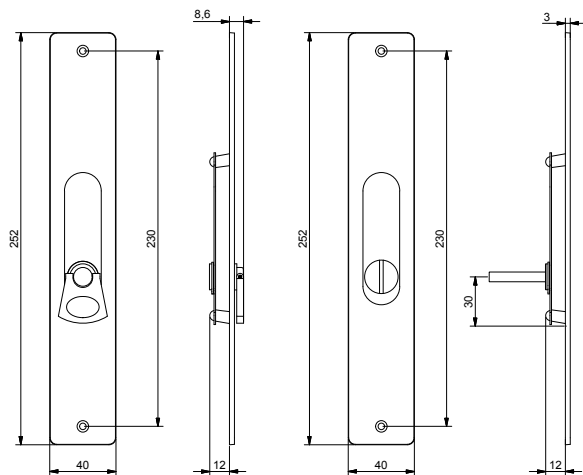

914 CP-LV

ART.

914 CP

Coppia placche incasso
Pair sliding door plates



	LV BG	OSC OC	
P	•	•	4

KIT

CD 932-LV



CD 946-LV



ART.

CD 932

Set con art. 914 CP + art 525 PI senza serratura
Set with art. 914 CP + art. 525 PI without lock

CD 946

Set con serratura 6SR E=50
Set with lock 6SR backset=50



	LV BG	OSC OC	
S2	•	•	1

art. **944** Coppia placche incasso con nottolino pendente 514 da ambo i lati
Pair sliding door plates with 514 pendent turn on both sides

 40-50
 regolabilità standard*

 6/8



944 CP-LV

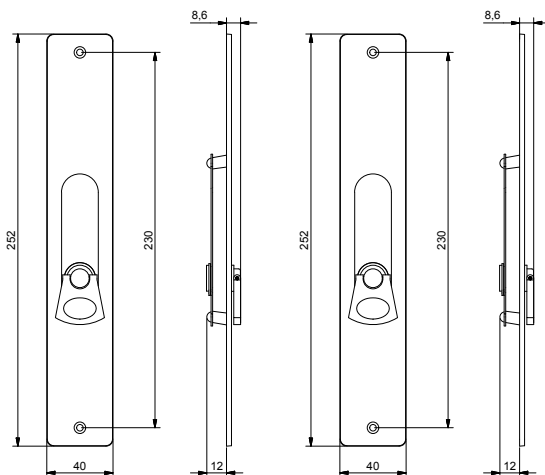

ART.

944 CP

Coppia placche incasso
Pair sliding door plates

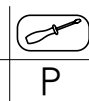

LV
BG

OSC
OC

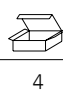

KIT

CD 9D2-LV



CD 9D6-LV

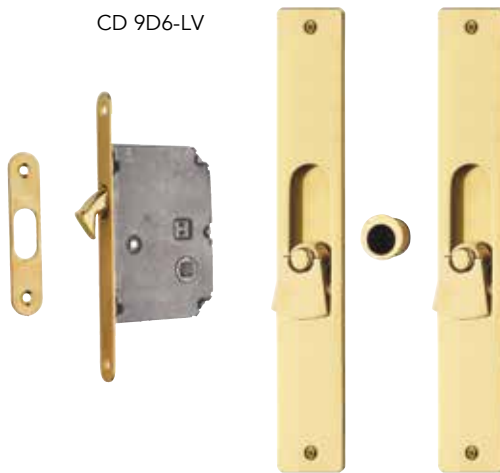

ART.

CD 9D2

Set con art. 944 CP + art 525 PI senza serratura
Set with art. 944 CP + art. 525 PI without lock



LV
BG

OSC
OC



CD 9D6

Set con serratura 6SR E=50
Set with lock 6SR backset=50

art. 954

Coppia placche incasso con nottolino pendente 555
 Pair sliding door plates with pendent turn 555

40-50
 regolabilità standard*



954 CP-LV

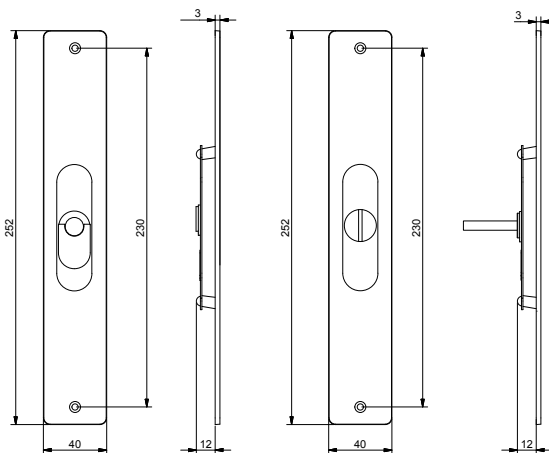

ART.

954 CP

Coppia placche incasso
 Pair sliding door plates



LV
 BG

OSC
 OC



P

•

•

4

KIT

CD 059-LV



CD 070-LV



ART.

CD 059

Set con art. 954 CP + art 525 PI senza serratura
 Set with art. 954 CP + art. 525 PI without lock

CD 070

Set con serratura 6SR E=50
 Set with lock 6SR backset=50



LV
 BG

OSC
 OC



S5

•

•

1

art. **802** Placca incasso cieca con elemento di chiusura a pressione
Round flush pull plate with closure push cap

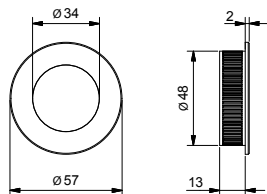

802 PI-OSC



802 PI-LV



802 PI-OC

ART.				LV	OSC OC	
802 PI 002	Placca incasso cieca <i>Blind sliding door plate</i>		S	•	•	24

KIT

CD 720-LV



CD 720-OC

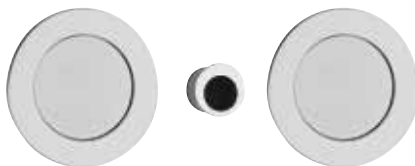

CD 719-LV



CD 719-OC



ART.			LV	OSC OC	
CD 720	Set con 2 art. 802PI002 + art 525 PI senza serratura <i>Set with 2 art. 802PI002 + art. 525 PI without lock</i>		•	•	1
CD 719	Set con 2 art. 802PI002 + art 826 PI senza serratura <i>Set with 2 art. 802PI002 + art. 826 PI without lock</i>		•	•	1

art. **Q82** Placca incasso cieca con elemento di chiusura a pressione
Square flush pull plate with closure push cap

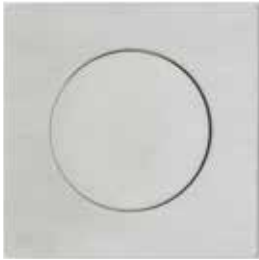
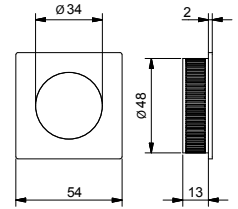

Q82 PI-OSC

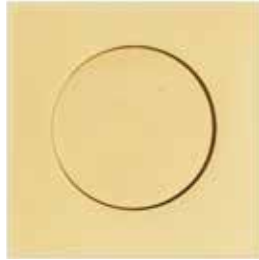

Q82 PI-LV



Q82 PI-OC

ART.

Q82 PI 002

Placca incasso cieca
Blind sliding door plate



	LV	OSC OC	
S	•	•	24

KIT

CD 72Q-LV



CD 72Q-OC



CD 71Q-LV

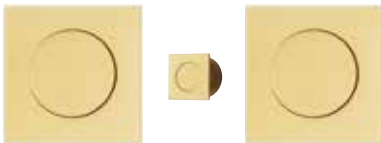

CD 71Q-OC



ART.

CD 72Q

Set con 2 art. Q82PI002 + art Q25 PI senza serratura
Set with 2 art. Q82PI002 + art. Q25 PI without lock

CD 71Q

Set con 2 art. Q82PI002 + art Q26 PI senza serratura
Set with 2 art. Q82PI002 + art. Q26 PI without lock



LV	OSC OC	
•	•	1
•	•	1

art. 524 Placca incasso tonda

Round sliding door plate



524 PI 001-LV





524 PI 002-OSC

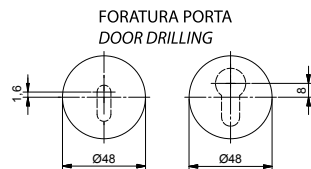
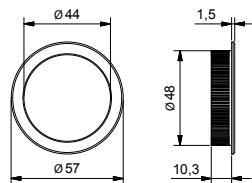

524 PI 011-OC



ART.			LV		OC	AN	AGV	VBN	RX	SNV	ZSC	ZCR	
			BG	OS	OSC	BGO	NR						
524 PI 001	Foro chiave Key hole	S	•	•	•	•	•	•	•	•	•	•	24
524 PI 002	Cieca Blind	S	•	•	•	•	•	•	•	•	•	•	24
524 PI 011	Foro yale Europrofile cylinder (yale)	S	•	•	•	•	•	•	•	•	-	-	24

KIT



CD 022-OSC



CD 023-LV



CD Y23-OC



CD 063-LV



CD Y63-OC

ART.			LV		OSC	AN	AGV	VBN	RX	SNV
			BG	OS	OC	BGO				
CD 022	Set con 2 art. 524 PI 002 + art 525 PI senza serratura Set with 2 art. 524 PI 002 + art. 525 PI without lock		•	•	•	•	•	•	•	•
CD 023	Set con 2 art. 524 PI 001 + art 525 PI senza serratura Set with 2 art 524 PI 001 + art. 525 PI without lock		•	•	•	•	•	•	•	•
CD Y23	Set con 2 art. 524 PI 011 + art 525 PI senza serratura Set with 2 art. 524 PI 011 + art. 525 PI without lock		•	•	•	•	•	•	•	•
CD 063*	Set con serratura 7SR E=50 con chiave snodata Set with lock 7SR backset=50 with pliable key	S1	•	•	•	•	•	•	•	-
CD Y63	Set con serratura 11SR E=50 Set with lock 11SR backset=50	S11	•	•	•	•	•	•	•	-

*A richiesta disponibile kit con 17SR TEKNO - art. CD 863



17SR

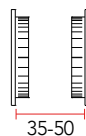

35-50

per/for CD 063 - 863

art. Q24 Placca incasso quadra

Square sliding door plate



Q24 PI 001-LV





Q24 PI 002-OSC

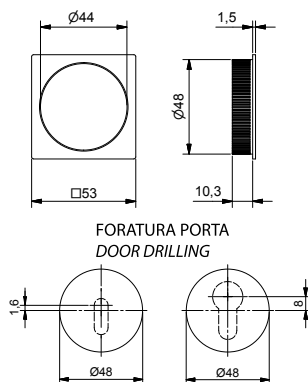

Q24 PI 011-OC



ART.				LV	OSC OC	SNV	ZSC ZCR	
Q24 PI 001	Con foro chiave With key hole		S	•	•	•	•	24
Q24 PI 002	Cieca Blind		S	•	•	•	•	24
Q24 PI 011	Con foro yale Europrofile cylinder (yale)		S	•	•	•	-	24

KIT



CD Q22-OSC



CD Q23-LV





CD Q2Y-OC



CD Q63-LV



CD Q6Y-OC

ART.				LV	OSC OC	SNV	
CD Q22	Set con 2 art. Q24 PI 002 + art Q25 PI senza serratura Set with 2 art. Q24 PI 002 + art. Q25 PI without lock			•	•	•	1
CD Q23	Set con 2 art. Q24 PI 001 + art Q25 PI senza serratura Set with 2 art. Q24 PI 001 + art. Q25 PI without lock			•	•	•	1
CD Q2Y	Set con 2 art. Q24 PI 011 + art Q25 PI senza serratura Set with 2 art. Q24 PI 011 + art. Q25 PI without lock			•	•	•	1
CD Q63	Set con serratura 7SR E=50 con chiave snodata Set with lock 7SR backset=50 with pliable key		S1	•	•	-	1
CD Q6Y	Set con serratura 11SR E=50 Set with lock 11SR backset=50		S11	•	•	-	1



35-50

per/for CD Q63

art. **529** Placca incasso con bordo di presa
Sliding door plate with rim grip



529 PI 001-LV



529 PI 002-OSC

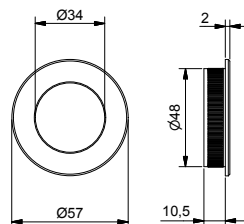

FORATURA PORTA
DOOR DRILLING

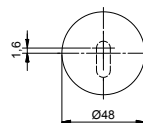

ART.

529 PI 001

Con foro chiave
With key hole

529 PI 002

Cieca
Blind



		LV BG	OC OSC	AN	AGV	VBN	NR	
529 PI 001	S	•	•	•	•	•	•	24
529 PI 002	S	•	•	•	•	•	•	24

KIT



CD 020-OSC



CD 021-LV



35-50*

per/for CD 061

* A richiesta disponibile articolo
per spessori porta 30-35 (CD055)



CD 061-LV

ART.

CD 020

Set con 2 art. 529 PI 002 cieche + art 525 PI senza serratura
Set with 2 art. 529 PI 002 blind + art. 525 PI without lock

CD 021

Set con 2 art. 529 PI 001 con foro chiave + art 525 PI senza serratura
Set with 2 art. 529 PI 001 with key hole + art. 525 PI without lock

CD 061

Set con serratura 7SR E=50 con chiave snodata
Set with lock 7SR backset=50 with pliable key



		LV BG	OSC OC	AN	AGV	VBN	NR	
CD 020		•	•	•	•	•	•	1
CD 021		•	•	•	•	•	•	1
CD 061	S1	•	•	•	•	•	-	1

art. **Q28** Placca incasso con bordo di presa
Square sliding door plate with rim grip



Q28 PI 002-OC



Q28 PI 002-LV

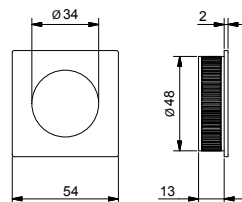

ART.

Q28 PI 002

Placche incasso cieca
Blind sliding door plate

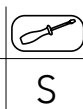

LV

•

OC
OSC

•



24

KIT



CD Q20-OC

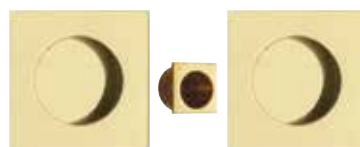

CD Q20-LV

ART.

CD Q20

Set con 2 art. Q28 PI 002 + art. Q25 PI senza serratura
Set with 2 art. Q28 PI 002 + art. Q25 PI without lock



LV

•

OC
OSC

•



1

art. 534 Placca incasso bassa con bordo di presa

Sliding door plate with rim grip

ATTENZIONE SPECIALE PER PORTE STRETTE SPESSORE MM. 30/35
ATTENTION SPECIAL FOR DOOR THICKNESS MM. 30/35

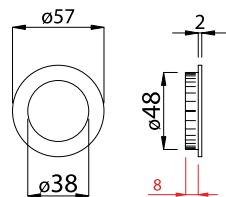

534 PI 001-LV



534 PI 002-LV

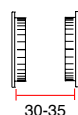

per porte strette
for reduced door thickness



OC









OSC



BG

KIT

ART.				LV BG	OC OSC	
534 PI 001	Con foro chiave With key hole		S	•	•	24
534 PI 002	Cieca Blind		S	•	•	24

ART.				LV BG	OC OSC	
CD 035 •	Set con 2 art. 534 PI 002 cieche + art 525 PI senza serratura Set with 2 art. 534 PI 002 blind + art. 525 PI without lock			•	•	1
CD 036 •	Set con 2 art. 534 PI 001 con foro chiave + art 525 PI senza serratura Set with 2 art. 534 PI 001 with key hole + art. 525 PI without lock			•	•	1
CD 055 *	Set con serratura 7SR E=50 con chiave snodata Set with lock 7SR backset=50 with pliable key		S1	•	•	1



CON SERRATURA
WITH LOCK

art. **808** Placca incasso in **acciaio stampato**
Sliding door plate **stamped steel**



808 PI 002-OTT. BRILL



808 PI 001-OTT. BRILL

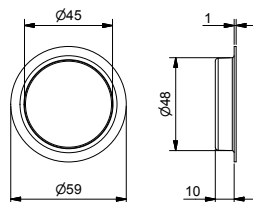

ART.				OTT. BRILL	SAT. CROM	CROM	BRONZ.	
808 PI 001	con foro chiave with key hole		S	•	•	•	•	24
808 PI 002	Cieca Blind		S	•	•	•	•	24

KIT



CD 832-SAT. CROM.

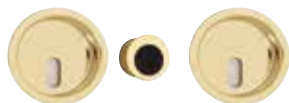

CD 833-OTT. BRILL

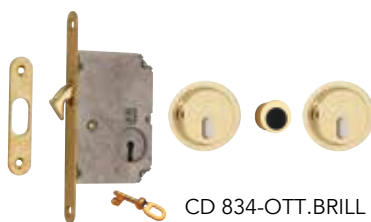



CD 834-OTT. BRILL

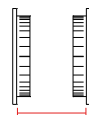

CD 835-OTT. BRILL



35-50
per/for CD 834 - 835

ART.				OTT. BRILL	SAT. CROM	CROM	
CD 832	Set con 2 art. 808 PI 002 + art 525 PI senza serratura Set with 2 art. 808 PI 002 + art. 525 PI without lock			•	•	•	1
CD 833	Set con 2 art. 808 PI 001 + art 525 PI senza serratura Set with 2 art. 808 PI 001 + art. 525 PI without lock			•	•	•	1
CD 834	Set con serratura 7SR E=50 con chiave snodata Set with lock 7SR backset=50 with pliable key		S1	•	•	•	1
CD 835	Set con serratura 17SR E=50 con chiave snodata Set with lock 17SR backset=50 with pliable key		S1	•	•	•	1

art. **805** Placca incasso flat ovale
Flat oval flush pull plate



805 PI-OTT.BRILL.



805 PI-ZCR



805 PI-ZSC

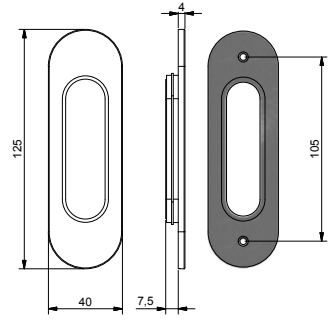

826 PI-OTT.BRILL.

826 PI-ZSC

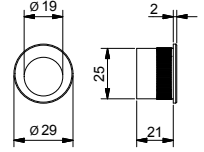

ART.				OTT. BILL. ZSC - ZCR	SNV	
805 PI	Placca incasso cieca Blind sliding door plate		S	•	•	12
826 PI	Frontale di trascinamento Flush pull handle		S	•	•	12

KIT



CD 730 ZSC

ART.			OTT. BILL. ZSC - ZCR	SNV	
CD 730	Set con 2 art. 805 PI + art 826 PI senza serratura Set with 2 art. 805 PI + art. 826 PI without lock		•	•	1

art. **Q85** Placca incasso flat rettangolare
Flat rectangular flush pull plate



Q85 PI-ZCR



Q85 PI-ZSC

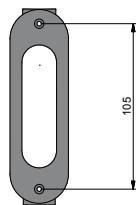
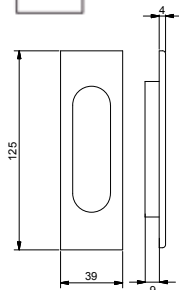

Q26 PI-ZSC

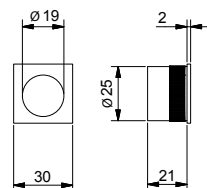

ART.



Q85 PI

Placca incasso cieca
Blind sliding door plate

Q26 PI

Frontale di trascinamento
Lush pull handle



	ZSC ZCR	SNV	
S	•	•	12
S	•	•	12

KIT



CD 73Q ZSC

ART.

CD 73Q

Set con 2 art. Q85 PI + art. Q26 PI senza serratura
Set with 2 art. Q85 PI + art. Q26 PI without lock



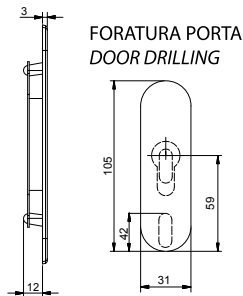
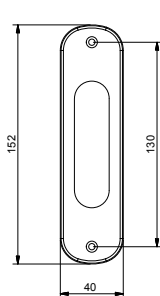

ZSC ZCR	SNV	
•	•	1

art. 520 Placca incasso
Sliding door plate



520 PI 0B1-LV 520 PI 001-LV 520 PI 002-OSC 520 PI 011-LV

ART.			LV BG OS	OC OSC	AN BGO	AGV	VBN	RX	
520 PI 001	Con foro chiave With key hole		V	•	•	•	•	•	16
520 PI 002	Cieca Blind		V	•	•	•	•	•	16
520 PI 011	Con foro yale With europrofile cylinder (yale)		V	•	•	•	•	•	16
520 PI 0B1	Con foro chiave in basso With key hole		V	•	•	•	•	•	16

KIT



CD 024-OSC



CD 025-LV





CD Y25-OC



CD 065-LV



CD Y65-OC

ART.				LV BG OS	OSC OC	AN BGO	AGV	VBN	RX	
CD 024	Set con 2 art. 520 PI 002 + art 525 PI senza serratura Set with 2 art. 520 PI 002 + art. 525 PI without lock			•	•	•	•	•	•	1
CD 025	Set con 2 art. 520 PI 001 + art 525 PI senza serratura Set with 2 art. 520 PI 001 + art. 525 PI without lock			•	•	•	•	•	•	1
CD Y25	Set con 2 art. 520 PI 011 + art 525 PI senza serratura Set with 2 art. 520 PI 011 + art. 525 PI without lock			•	•	•	•	•	•	1
CD 065*	Set con serratura 7SR E=50 con chiave snodata Set with lock 7SR backset=50 with pliable key		S8	•	•	•	•	•	•	1
CD Y65	Set con serratura 11SR E=50 Set with lock 11SR backset=50		S8	•	•	•	•	•	•	1

*A richiesta disponibile kit con 17SR TEKNO - art. CD 865

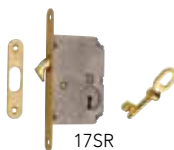

17SR

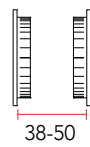

38-50

per/for CD 065 - 865

art. **521** Placca incasso coprivite
Cover screw sliding door plate

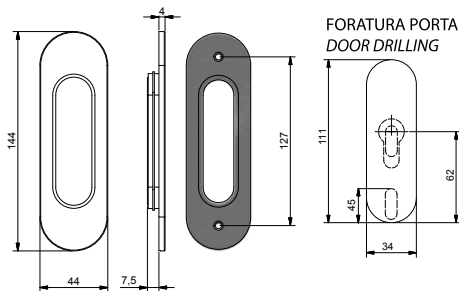

521 PI 0B1-OSC 521 PI 001-OSC 521 PI 002-OC 521 PI 011-LV

ART.				LV BG OS	OSC OC	
521 PI 001	Con foro chiave With key hole		V	•	•	16
521 PI 002	Cieca Blind		V	•	•	16
521 PI 011	Con foro yale With europrofile cylinder (yale)		V	•	•	16
521 PI 0B1	Con foro chiave in basso With key hole		V	•	•	16

KIT



CD 026-OC



CD 027-OSC



CD Y27-LV



CD 067-OSC

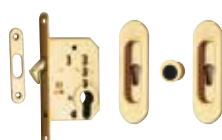

CD Y67-LV

ART.				LV BG OS	OSC OC	
CD 026	Set con 2 art. 521 PI 002 + art 525 PI senza serratura Set with 2 art. 521 PI 002 + art. 525 PI without lock			•	•	1
CD 027	Set con 2 art. 521 PI 001 + art 525 PI senza serratura Set with 2 art. 521 PI 001 + art. 525 PI without lock			•	•	1
CD Y27	Set con 2 art. 521 PI 011 + art 525 PI senza serratura Set with 2 art. 521 PI 011 + art. 525 PI without lock			•	•	1
CD 067*	Set con serratura 7SR E=50 con chiave snodata Set with lock 7SR backset=50 with pliable key		S9	•	•	1
CD Y67	Set con serratura 11SR E=50 Set with lock 11SR backset=50		S9	•	•	1

*A richiesta disponibile kit con 17SR TEKNO - art. CD 867

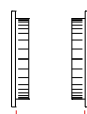
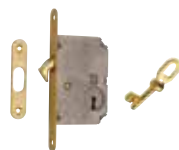



35-50

per/for CD 067 - 867

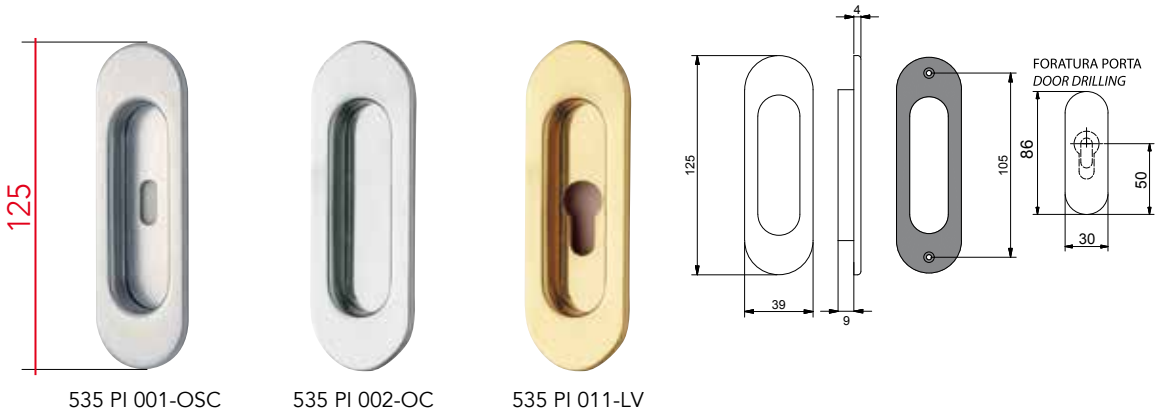

art. **535** Placche incasso coprivite
Cover screw sliding door plates



ART.				LV BG OS	OSC OC	INOX SAT.	
535 PI 001	Con foro chiave With key hole	V	•	•	•	16	
535 PI 002	Cieca Blind	V	•	•	•	16	
535 PI 011	Con foro yale With europrofile cylinder (yale)	V	•	•	•	16	

KIT



ART.				LV BG OS	OSC OC	
CD 038	Set con 2 art. 535 PI 002 + art 525 PI senza serratura Set with 2 art. 535 PI 002 + art. 525 PI without lock			•	•	1
CD 039	Set con 2 art. 535 PI 001 + art 525 PI senza serratura Set with 2 art. 535 PI 001 + art. 525 PI without lock			•	•	1
CD Y39	Set con 2 art. 535 PI 011 + art 525 PI senza serratura Set with 2 art. 535 PI 011 + art. 525 PI without lock			•	•	1
CD 056	Set con serratura 7SR E=50 con chiave snodata Set with lock 7SR backset=50 with pliable key		S10	•	•	1
CD Y56	Set con serratura 11SR E=50 Set with lock 11SR backset=50		S10	•	•	1

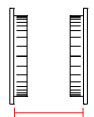

35-50
per/for CD 056

art. Q35 Placca incasso coprivite rettangolare

Rectangular cover screw sliding door plate



Q35 PI 001-OSC



Q35 PI 002-OC



Q35 PI 011-LV

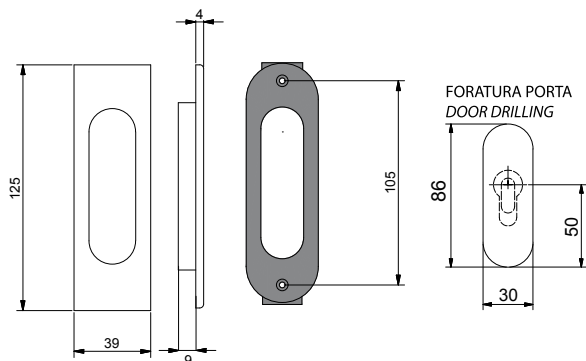

ART.

Q35 PI 001

Con foro chiave
With key hole

Q35 PI 002

Cieca
Blind

Q35 PI 011

Con foro yale
With europrofile cylinder (yale)



LV
BG OS

OSC
OC

INOX
SAT.



V

•

•

•

16

V

•

•

•

16

V

•

•

•

16

KIT



CD 938-OC



CD 939-OSC



CD YR9-LV



CD 956-OSC



CD YR6-LV

ART.

CD 938

Set con 2 art. Q35 PI 002 + art 525 PI senza serratura
Set with 2 art. Q35 PI 002 + art. 525 PI without lock

CD 939

Set con 2 art. Q35 PI 001 + art 525 PI senza serratura
Set with 2 art. Q35 PI 001 + art. 525 PI without lock

CD YR9

Set con 2 art. Q35 PI 011 + art 525 PI senza serratura
Set with 2 art. Q35 PI 011 + art. 525 PI without lock

CD 956

Set con serratura 7SR E=50 con chiave snodata
Set with lock 7SR backset=50 with pliable

CD YR6

Set con serratura 11SR E=50
Set with lock 11SR backset=50



LV
BG OS

OSC
OC

INOX
SAT.



S10

•

•

-

1

S10

•

•

-

1



35-50
per/for CD 956

art. 252 Placcha incasso Sliding door plate

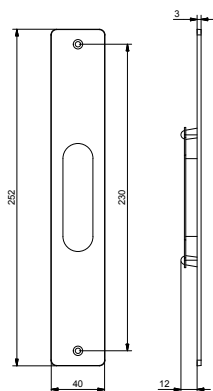

FORATURA PORTA
DOOR DRILLING

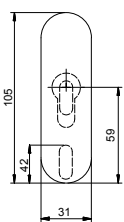

252 PI 001-LV 252 PI 0B1-LV 252 PI 002-OSC 252 PI 011-OC

ART.				LV	OSC OC	
252 PI 001	Con foro chiave With key hole		V	•	•	8
252 PI 002	Cieca Blind		V	•	•	8
252 PI 011	Con foro yale With europrofile cylinder (yale)		V	•	•	8
252 PI 0B1	Con foro chiave in basso With key hole		V	•	•	8

KIT



CD 924-OSC



CD 925-LV



CD 9Y5-OC

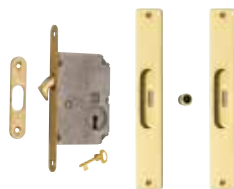

CD 965-LV



CD 96Y-OC

ART.				LV BG	OSC OC	
CD 924	Set con 2 art. 252 PI 002 + art 525 PI senza serratura Set with 2 art. 252 PI 002 + art. 525 PI without lock			•	•	1
CD 925	Set con 2 art. 252 PI 001 + art 525 PI senza serratura Set with 2 art. 252 PI 001 + art. 525 PI without lock			•	•	1
CD 9Y5	Set con 2 art. 252 PI 011 + art 525 PI senza serratura Set with 2 art. 252 PI 011 + art. 525 PI without lock			•	•	1
CD 965	Set con serratura 7SR E=50 con chiave snodata Set with lock 7SR backset=50 with pliable key		S8	•	•	1
CD 96Y	Set con serratura 11SR E=50 Set with lock 11SR backset=50		S8	•	•	1

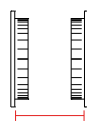

35-50
per/for CD 965

art. **580** Coppia placche incasso con nottolino ad anello
Pair sliding door plates with ring turn

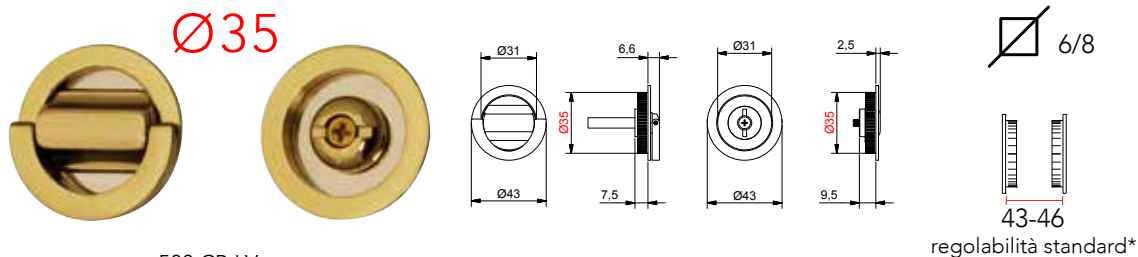

580 CP-LV

regolabilità standard*

* A richiesta disponibile articolo con ferro per spessori porta da 30 a 42 specificando sempre sull'ordine l'esatto spessore porta.

ART.				LV	OSC	
580 CP	Coppia placche incasso <i>Pair sliding door plates</i>			BG	OC	

art. **581** Coppia placche incasso con nottolino ad anello da ambo i lati
Pair sliding door plates with ring turn on both sides

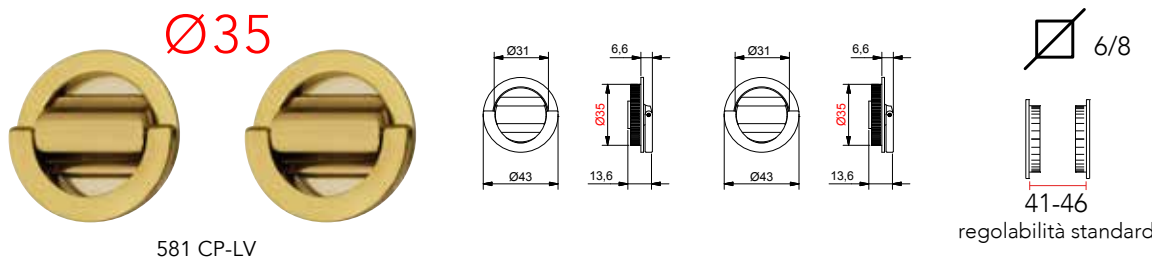

581 CP-LV

regolabilità standard

ART.				LV	OSC	
581 CP	Coppia placche incasso <i>Pair sliding door plates</i>			BG	OC	

art. **582** Coppia placche incasso con nottolino ad anello e folle
Pair sliding door plates with ring turn and roller ring

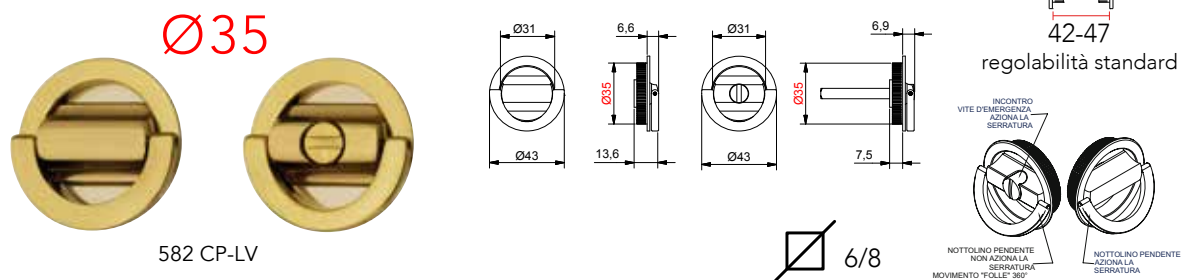

582 CP-LV

regolabilità standard

ART.				LV	OSC	
582 CP	Coppia placche incasso <i>Pair sliding door plates</i>			BG	OC	

art. 051 PI - EASY

design: Studio Reguitti
 materiale: Zama
 material: Zamak

Frontale di trascinamento con pendente di presa
 Door Edge flush pull handle

TeKnoMetal
 Linea in zama

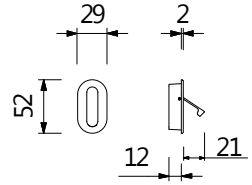

Multiuoso
 Multipurpose

Facilità di installazione
 Easy to Mounting

Silenzioso
 Silent



VERSIONI / VERSIONS



Finiture Finishes	BN NR	ZLV BGO	ZBG	ZSC ZCR	SNV	AGV	AN
----------------------	----------	------------	-----	------------	-----	-----	----

FRONTALE DI TRASCINAMENTO CON PENDENTE DI PRESA / DOOR EDGE FLUSH PULL HANDLE WITH PENDENT	€	€	€	€	€	€	€
051 PI *** Frontale di trascinamento con pendente di presa Door Edge flush pull handle with pendent	•	•	•	•	•	•	•

art. **525** Frontale di trascinamento tondo
Round Flush pull hole



525 PI-LV



525 PI-OC



525 PI-AGV



525 PI-BGO



525 PI-AN



525 PI-OSC

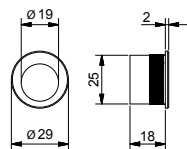

ART.	LV BG OS	OSC OC NR	AN BGO	AGV	RX	SNV	VBN	
525 PI Frontale di trascinamento Flush pull handle	•	•	•	•	•	•	•	24

art. **Q25** Frontale di trascinamento quadro
Square Flush pull hole



Q25 PI-OSC



Q25 PI-OC



Q25 PI-LV

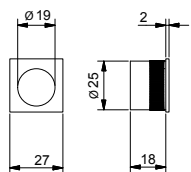

ART.	LV BG	OSC OC	SNV	
Q25 PI Frontale di trascinamento Flush pull handle	•	•	•	24

art. **524 RO** Cornice per placche ad incasso - ROSETTA SALVAPORTA
Frame for pair sliding door plate ø48



524 RO-LV



BG



OSC

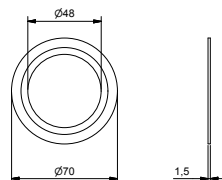

ART.	LV BG	OSC OC	
524 RO Cornice per placche con incasso ø48 Frame for pair sliding door plate ø48	•	•	12

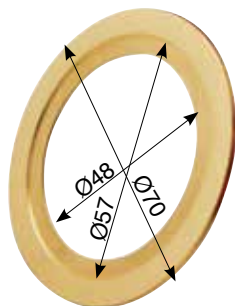

524 RO-LV



ESEMPIO DI APPLICAZIONE
MOUNTING EXAMPLE

Utensile Monta Incontro di serrature a gancio per porte scorrevoli Tool position guide for hook lock striker

IDEA REGUITTI

per risolvere velocemente in 2 semplici passaggi i problemi legati al centraggio in cantiere della serratura all'incontro (contro piastra)
Se ne consiglia l'uso per i kit con serratura 6SR - 7SR - 16SR - 17SR - 11SR

FUNZIONE:

1. INDIVIDUAZIONE ESATTA DELL'AREA da forare sullo stipite per l'alloggiamento dell'incontro;
2. ELIMINARE FASE DI REGISTRO con montaggio semplice e sicuro al primo gesto



UMI
BPLTPKSR6**4A



①



Stipite

②



Stipite

La corretta posizione del foro per l'incontro e il fissaggio dello stesso sullo stipite vengono indicati dai tre punzoni incorporati nell' UMI che trasferiscono precisi riferimenti sullo stipite una volta che l'anta sia stata spinta dolcemente contro il telaio.

RISULTATO:

1. MONTAGGIO PRECISO dell'incontro sullo stipite: la precisione della foratura e del montaggio dell'incontro consentono una sempre ottima chiusura della serratura anche a fronte di cedimenti verticali della porta (assestamento) successivamente all'installazione fino a 3 mm.

2. VELOCITÀ DI MONTAGGIO:
risparmio di almeno il 50%
del tempo rispetto
all'operazione di montaggio
tradizionale

ART.

BPLTPKSR6**4A

UMI

Tool position guide



art. 429

Placca ad incasso tonda con bordo di presa
Round blind sliding door plate with rim grip



429 PI 002-LV

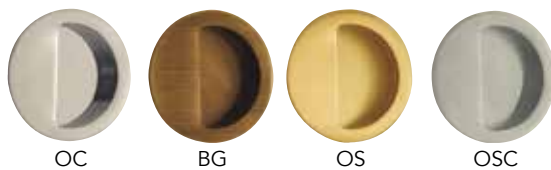

OC BG OS OSC

ART.

429 PI 002

Placca incasso
Sliding door plate



LV	OSC	
BG OS	OC	
•	•	24

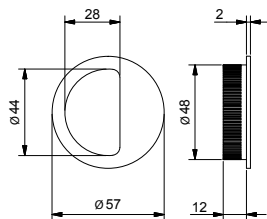

art. Q29

Placca ad incasso quadra con bordo di presa
Square blind sliding door plate with rim grip



Q29 PI 002-OC

ART.

Q29 PI 002

Placca incasso
Sliding door plate



LV	OSC	
BG OS	OC	
•	•	24

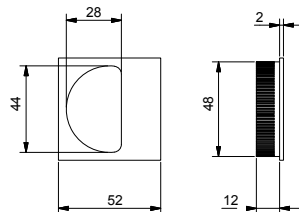

art. 048

Placca ad incasso tonda con anello di presa e vite di connessione passante
Round blind sliding door plate with flush pull ring and passing screw



048 PI 002-LV



VISTA RETRO

ART.

048 PI 002

Placca incasso
Sliding door plate



LV	OSC	
	OC	
•	•	24

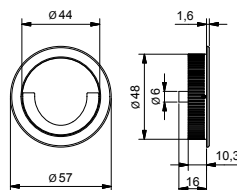

art. 048

Coppia placche incasso con doppio anello di presa a filo con vite di connessione passante
Pair sliding door plates with flush pull ring on both sides and passing screw



048 CP-OSC

ART.

048 CP

Coppia placche incasso
Pair sliding door plate



LV	OSC	
	OC	
•	•	6

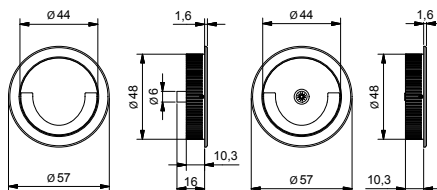

art. **Q48** Placca incasso quadra con anello di presa con vite di connessione passante
Square sliding door plate with flush pull ring and passing screw



Q48 PI 002-OSC



VISTA RETRO

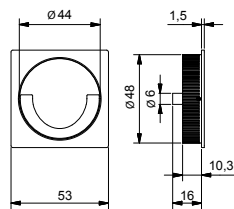

ART. Q48 PI 002 Coppia placche incasso
Pair sliding door plate



LV	OSC	
BG OS	OC	
•	•	24

art. **048** Coppia placche incasso con anello di presa con vite di connessione passante
Pair sliding door plates with flush pull ring and passing screw



048 CP 00Q-OSC

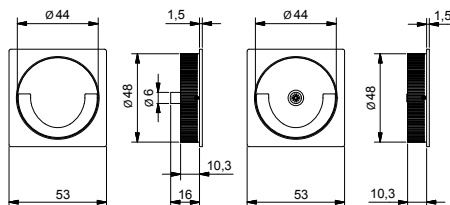

ART. 048 CP 00Q Coppia placche incasso
Pair sliding door plate



LV	OSC	
BG OS	OC	
•	•	6

art. **803** Placca ad incasso tonda con elemento di chiusura a pressione e vite di connessione passante
Round flush pull plate with closure push cap



803 PI 002-OC



VISTA RETRO

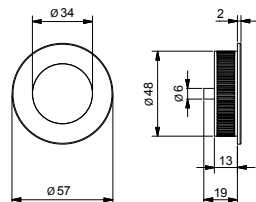

ART. 803 PI 002 Coppia placche incasso
Pair sliding door plate



LV	OSC	
	OC	
•	•	24

art. **Q83** Placca ad incasso quadra con elemento di chiusura a pressione
Square flush pull plate with closure push cap



Q83 PI 002-OC



VISTA RETRO

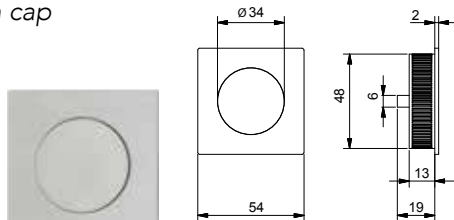

Q83 PI 002-OSC

ART. Q83 PI 002 Coppia placche incasso
Pair sliding door plate



LV	OSC	
	OC	
•	•	24

art. **530** Placca incasso tonda con anello di presa con vite di connessione passante
Round sliding door plate with ring grip and passing screw



530 PI 002-OSC



VISTA RETRO

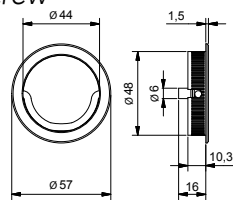

ART.

530 PI 002

Coppia placche incasso
Pair sliding door plate



LV	OSC	BGO	
BG OS	OC	AN	
•	•	•	24

art. **543** Coppia placche incasso con anello di presa con vite di connessione passante
Pair sliding door plates with ring grip with passing screw



543 CP-OSC



LV

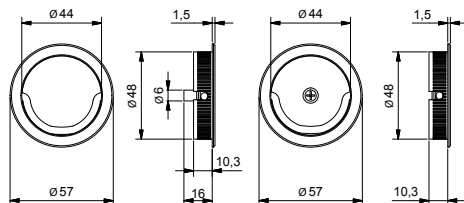

ART.

543 CP

Coppia placche incasso
Pair sliding door plate



LV	OSC	BGO	
BG	OC	AN	
•	•	•	6

art. **Q30** Placca incasso quadra con anello di presa con vite di connessione passante
Square sliding door plate with ring grip with passing screw



Q30 PI 002-OSC



VISTA RETRO

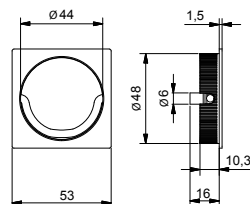

ART.

Q30 PI 002

Coppia placche incasso
Pair sliding door plate



LV	OSC	
	OC	
•	•	24

art. **543** Coppia placche incasso con anello di presa con vite di connessione passante
Pair sliding door plates with ring grip with passing screw



543 CP 00Q-OSC

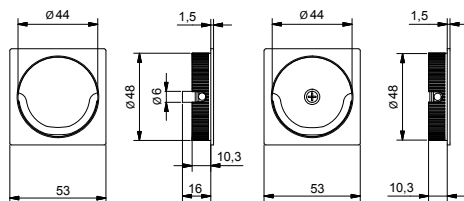

ART.

543 CP 00Q

Coppia placche incasso
Pair sliding door plate



LV	OSC	
BG	OC	
•	•	6

art. 524 Placca incasso
Sliding door plate



524 CP-OSC



LV

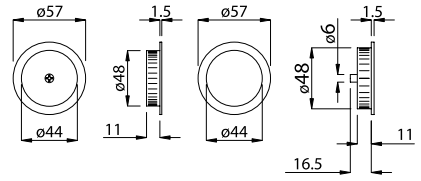

ART.

524 CP

Coppia placche ad incasso $\varnothing 48$ con vite di connessione passante
Pair sliding door plate $\varnothing 48$ with passing screw

LV BG	OSC OC	
•	•	6

art. 529 Placca incasso
Sliding door plate



529 CP-OSC



OC

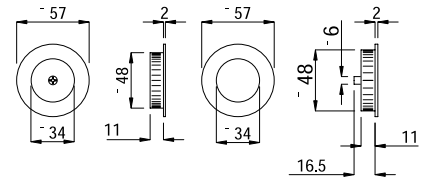

ART.

529 CP

Coppia placche ad incasso $\varnothing 48$ con con bordo di presa con vite di connessione passante
Pair sliding door plate $\varnothing 48$ with rim grip and with passing screw

LV BG	OSC OC	
•	•	6

art. 536 Placca incasso per porte vetro
Sliding door plate

PER VETRO / FOR GLASS



536 PI-LV

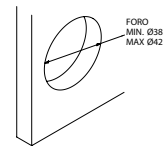
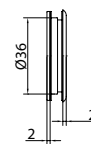
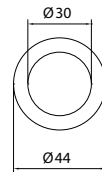

536 PI-OC

ART.

536 PI

Placca ad incasso $\varnothing 36$ cieca
Blind Sliding door plate $\varnothing 36$



LV	OSC OC	
•	•	24

art. **532** Placca incasso con bordo di presa
Sliding door plate



532 PI 002-LV



OC



OSC

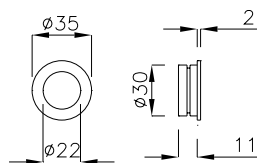

ART.		LV	OSC OC	
532 PI 002	Placca ad incasso Ø 30 - cieca e con bordo di presa <i>Blind sliding door plate with rim grip</i>	•	•	50

art. **533** Placca incasso con bordo di presa
Sliding door plate



533 PI 002-LV



OC



OSC

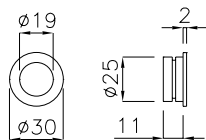

ART.		LV	OSC OC	
533 PI 002	Placca ad incasso Ø 25 - cieca e con bordo di presa <i>Blind sliding door plate with rim grip</i>	•	•	50

art. **526** Placca incasso con bordo di presa
Sliding door plate



526 PI 001-LV



526 PI 002-LV



OC



OSC

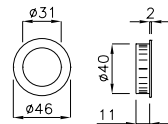

ART.		LV	OSC OC	
526 PI 001	Placca ad incasso Ø 40 - con foro chiave e con bordo di presa <i>Sliding door plate with key hole and rim grip</i>	•	•	24
526 PI 002	Placca ad incasso Ø 40 - cieca e con bordo di presa <i>Blind sliding door plate with rim grip</i>	•	•	24

art. **527** Placca incasso con bordo di presa
Sliding door plate



527 PI 001-LV



527 PI 002-LV



OC



OSC



BG

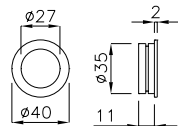

ART.		LV BG	OSC OC	
527 PI 001	Placca ad incasso Ø 35 - con foro chiave e con bordo di presa <i>Sliding door plate with key hole and rim grip</i>	•	•	24
527 PI 002	Placca ad incasso Ø 35 - cieca e con bordo di presa <i>Blind sliding door plate with rim grip</i>	•	•	24

art. **522** Placca a filo
Sliding door plate

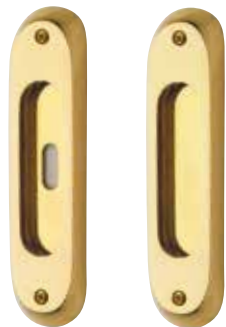

522PI001-LV 522PI002-LV



BG OSC

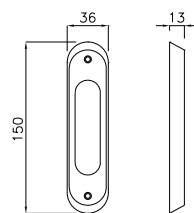

ART.

522 PI 001	Placca a filo (senza incasso) con foro chiave Sliding door plate (to apply without milling) with key hole	•	•	16
522 PI 002	Placca a filo (senza incasso) cieca Blind sliding door plate (to apply without milling)	•	•	16



LV BG	OSC OC	
•	•	16
•	•	16

art. **523** Placca incasso
Sliding door plate



523PI001-LV 523PI002-LV



BG OSC

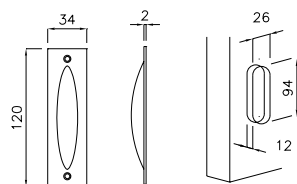

ART.

523 PI 001	Placca incasso con foro chiave Sliding door plate with key hole	•	•	16
523 PI 002	Placca incasso cieca Blind sliding door plate)	•	•	16



LV BG	OSC OC	
•	•	16
•	•	16

art. **531** Placca incasso
Sliding door plate



531 PI 002-LV



vista retro

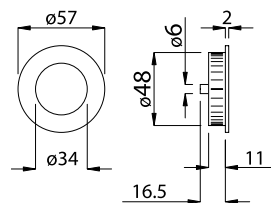

ART.

531 PI 002	Placca ad incasso $\varnothing 48$ - cieca con bordo di presa e montaggio a vite passante Blind sliding door plate with rim grip and passing screw	•	•	24
------------	---	---	---	----



LV BG	OSC OC	
•	•	24

art. 6 SR

Serratura con foro $\varnothing 8$ - E50 - bordo tondo
 Lock with square hole mm 8 - **backset=50** - round edge

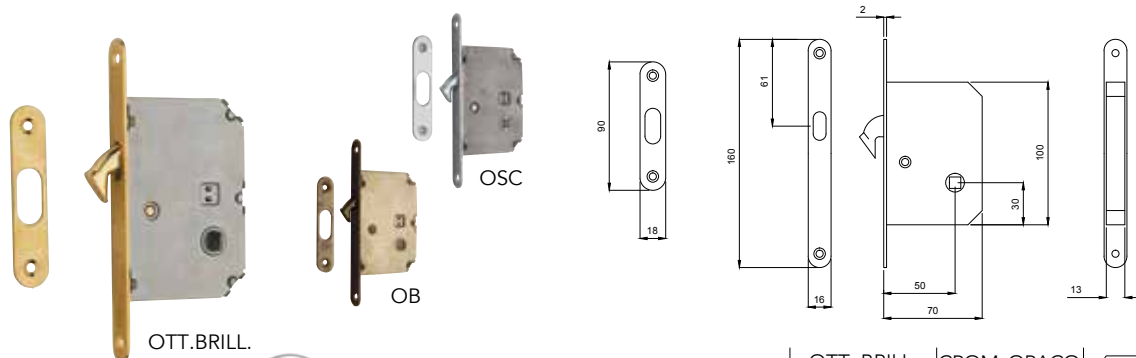

ART.

006 SR 50T

Serratura entrata 50

OTT. BRILL.
BRONZATO

CROM. OPACO
CROMATO



6

art. 6 SR

Serratura con foro $\varnothing 8$ - E30 - bordo tondo
 Lock with square hole mm 8 - **backset=30** - round edge

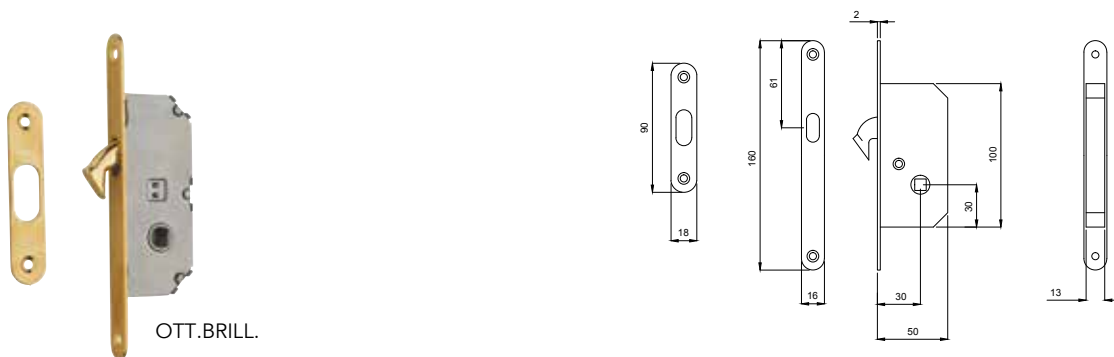

ART.

006 SR 30T

Serratura entrata ridotta

OTT. BRILL.
BRONZATO

CROM. OPACO
CROMATO



6

art. 6 SR

Serratura con foro $\varnothing 8$ - E40 - bordo tondo
 Lock with square hole mm 8 - **backset=40** - round edge

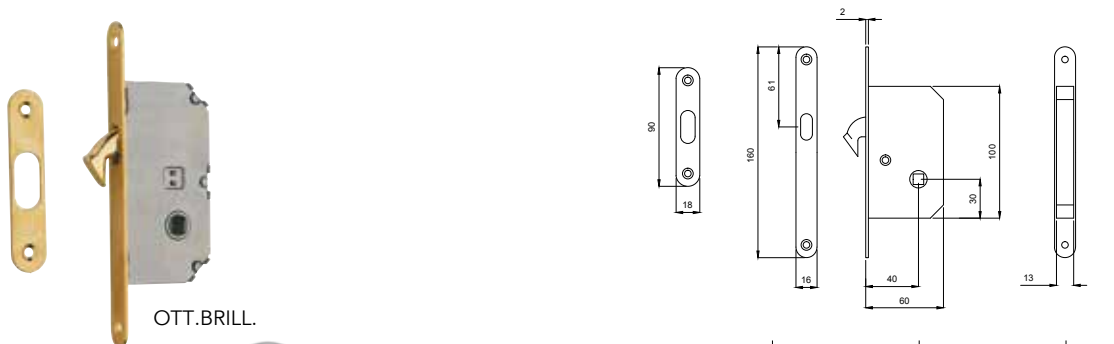

ART.

006 SR 40T

Serratura entrata ridotta

OTT. BRILL.
BRONZATO

CROM. OPACO
CROMATO



6

art.7 SR Serratura con foro chiave - E50 - bordo tondo senza chiave
 Lock with key hole - **backset=50** - round edge without key

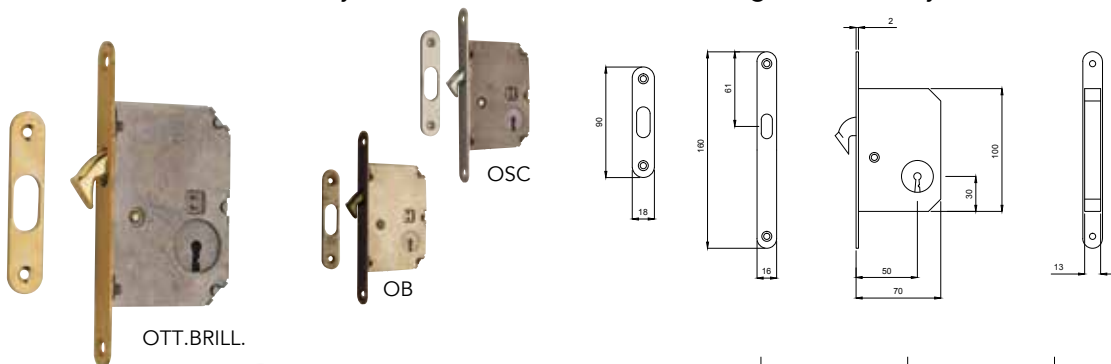

ART.		OTT. BRILL. BRONZATO	CROM. OPACO CROMATO	
007 SR 50T	Serratura entrata 50	•	•	6

art.7 SR Serratura con foro chiave - E30 - bordo tondo senza chiave
backset=30

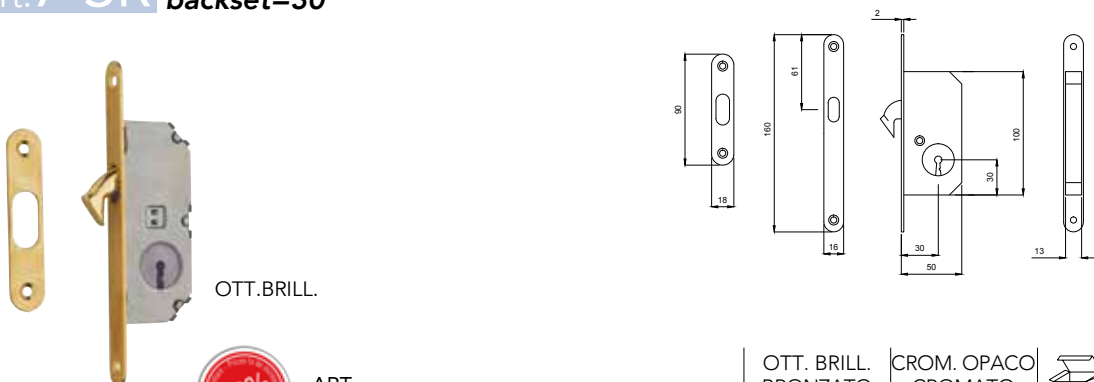

ART.		OTT. BRILL. BRONZATO	CROM. OPACO CROMATO	
007 SR 30T	Serratura entrata ridotta	•	•	6

art.7 SR Serratura con foro chiave - E40 - bordo tondo senza chiave
 Lock with key hole - **backset=40** - round edge without key

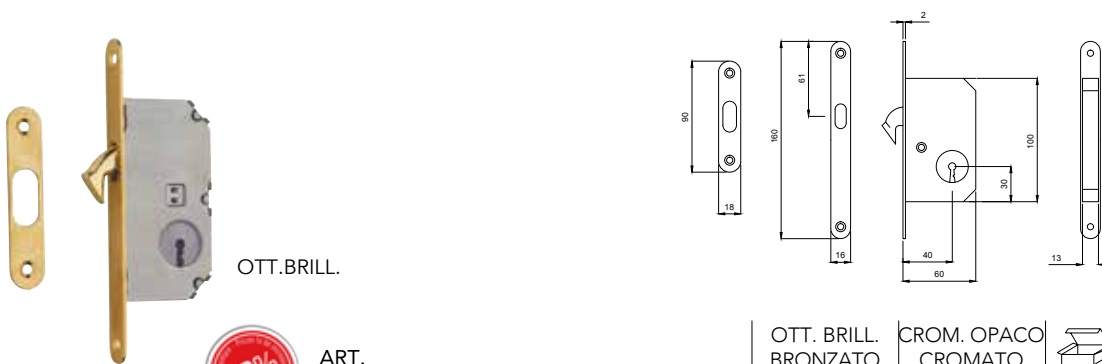

ART.		OTT. BRILL. BRONZATO	CROM. OPACO CROMATO	
007 SR 40T	Serratura entrata ridotta	•	•	6

art. 11 SR Serratura con foro yale - E50 - bordo tondo*
 Lock with yale hole - backset=50 - round edge*

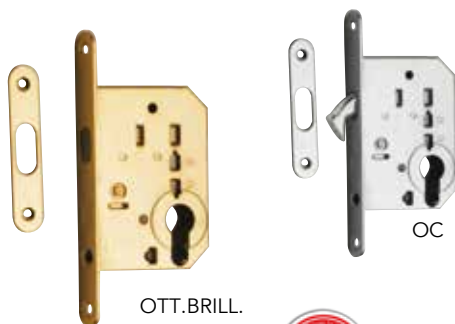

OTT.BRILL.



ART.

011 SR 50T Serratura entrata 50*

*A richiesta entrata 40 - on request 40mm backset

OTT. BRILL. BRONZATO	CROM. OPACO CROMATO	
•	•	6

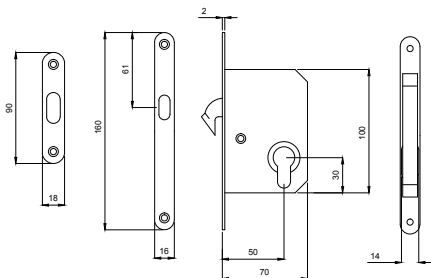

art. 16 SR Serratura TEKNO con foro Q.8 E=50 bordo tondo
 Lock TEKNO with square hole mm 8 backset = 50 - round edge



OTT.BRILL.



ART.

16 SR

Serratura TEKNO
 Lock TEKNO

OTT. BRILL. BRONZATO	CROM. OPACO CROMATO	
•	•	6

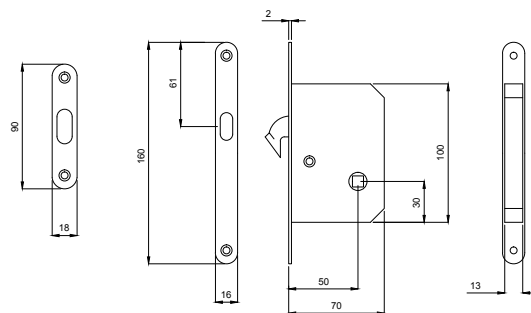

art. 17 SR Serratura con chiave snodata E=50 bordo tondo con chiave snodata
 Lock with key hole backset = 50 - round edge with key



OTT.BRILL.



ART.

17 SR

Serratura TEKNO
 Lock TEKNO

OTT. BRILL. BRONZATO	CROM. OPACO CROMATO	
•	•	6

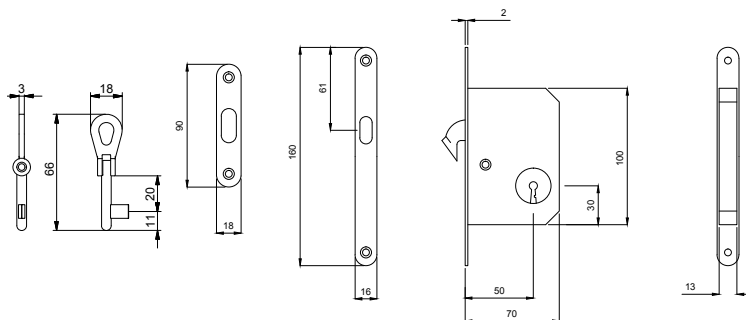

art. 12 SR 50T

Serratura "SMART" con foro quadro 8 - E50 - bordo tondo
 Lock "SMART" with square hole mm 8 - backset=50 - round edge

1 - Nuovo sistema di CHIUSURA A GANCIO:
 semplifica il montaggio in opera della porta
 New hook closing system

TRADIZIONALE

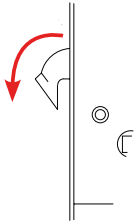

"SMART"

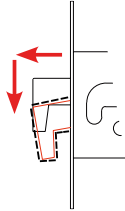

2 - DIMENSIONI CONTENUTE

rispetto alla serratura tradizionale: riduce i tempi di lavorazione sulla linea di produzione della porta.
 Reduced size lock

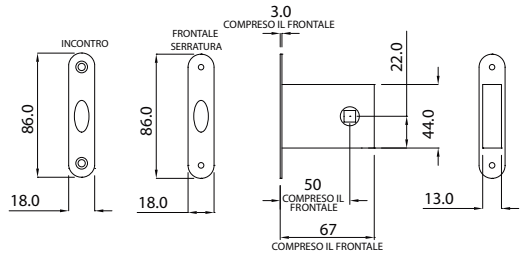

3 - QUADRO IN CENTRO alla serratura.
 Centered square hole

TRADIZIONALE

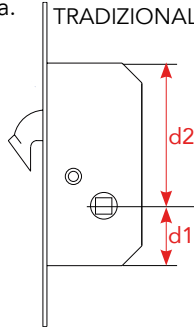
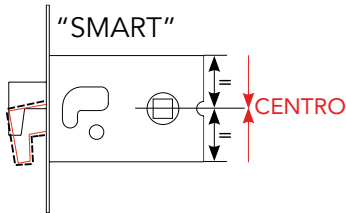

4 - ESTETICA MIGLIORATA:

unificate le dimensioni del frontalino con quelle dell'incontro.
 Improved aesthetic

5 - Frontale acquistabile separatamente
 Forend plate sold separately

BREVETTATO/PATENTED



ART.

012 SR 50T

Serratura con foro quadro 8 - E50 - bordo tondo
 Lock with square hole mm 8 - backset=50 - round edge

OTT.
BRILL. OB

OSC
OC



•

•

6

ART.

B012 PT
OTT.BRILL.

Frontale serratura
Forend plate

OTT.
BRILL. OB

OSC
OC



•

•

12

B012 IN 00S

Incontro normale per serrature 12 SR e 13 SR
 Standard striker for 12 SR and 13 SR

•

•

12



B012 PT

B012 IN 00S

006

PIASTRINA CIECA
 Blind plate

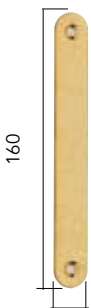

16



ART.

006 PT 002

Piastrina copriscasso
 Plate cover hole

OTT. BRILL.
BRONZATO

CROM. OPACO
CROMATO



•

•

16

art. 13 SR 50 T SERRATURA "SMART"



OSC

BREVETTATO/PATENTED



ART. 013SR50T0S Serratura con foro chiave - E50 bordo tondo con chiave
Lock with key hole backset 50 - round edge with key

OTT. BRILL OB	OSC OC	
•	•	6



CD 093 - OSC



ART. CD093 Set con 2 art. 424 PI ø 48 c/foro chiave
+ art. 525 PI + art. 13SR E = 50

LV BG	OSC OC	
•	•	1

art. 007 CHIAVE SNODATA

Pliable Key

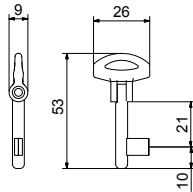

ART. 007 CH BON OS

BONAITI

OTT. BRILL
BRONZATO

CROM. OPACO
CROMATO



12

art. 007 CHIAVE DRITTA

Straight Key

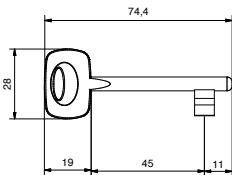

ART. 007 CH BON OD

BONAITI

OTT. BRILL
BRONZATO

CROM. OPACO
CROMATO



12

INCONTRI PER SERRATURE 6 SR - 7 SR

Blind plate



B006 IN 00L B006 IN 00S

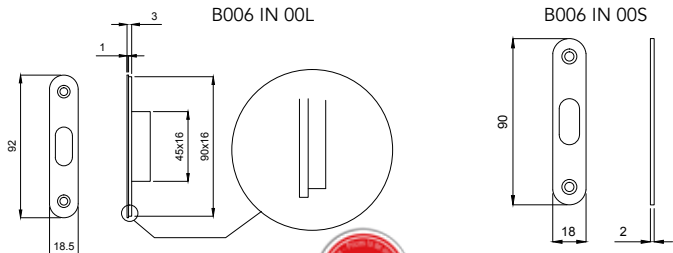

ART.

B006 IN 00L

Incontro per porte a libro
Strike for folding doors

B006 IN 00S

Incontro normale
Standard strike for 6 SR - 7 SR locks

OTT. BRILL
BRONZATO

CROM. OPACO
CROMATO



12

12



B050V7070
B050V7090
B050V7110
B050V7120



B010F6070
B010F6080
B010F6115
B010F6150



Maniglione singolo
Single Pull Handle



Maniglione accoppiato
Pair Pull Handle



CD 311



CD 313



Spessore porta Door Thickness
mm mm

Ferri per alzanti

		Spessore porta Door Thickness mm	Spessore porta Door Thickness mm	€
B010F6070	Ferro 10x70 smussato per maniglione singolo	58 • 68 78 • 92		•
B010F6080	Ferro 10x80 smussato per maniglione singolo	92 • 105		•
B010F6115	Ferro 10x115 smussato per maniglione accoppiato		58 • 68 • 78	•
B010F6150	Ferro 10x150 smussato per maniglione accoppiato		92 • 105	•

Viti per alzanti

B050V7070	Vite M5x70 per maniglione singolo	58 • 68		•
B050V7090	Vite M5x90 per maniglione singolo o accoppiato	78 • 92	58 • 68	•
B050V7110	Vite M5x110 per maniglione singolo o accoppiato	105	78 • 92	•
B050V7120	Vite M5x120 per maniglione accoppiato		105	•
CD 311	Set per maniglioni singoli: 2 viti M5x70, 2 Viti M5x90, 1 quadro 10x70 Set for single pull handle: 2 screws M5x70, 2 screws M5x90, 1 square pin 10x70			•
CD 313	Set per coppia maniglioni: 2 viti M5x90, 2 Viti M5x110, 2 dadi M5, 1 quadro 10x115 Set for pair pull handle: 2 screws M5x90, 2 screws M5x110, 2 nuts M5, 1 square pin 10x115			•

Info tecnica maniglioni per sistema alzante scorrevole Technical info pull handles for lift and slide system

A richiesta movimento in metallo a **4 posizioni** e fissaggio con viti passanti **interasse 63 mm**
On request metal mechanism **with 4 releases** and bolts through fixing center to center **63 mm**

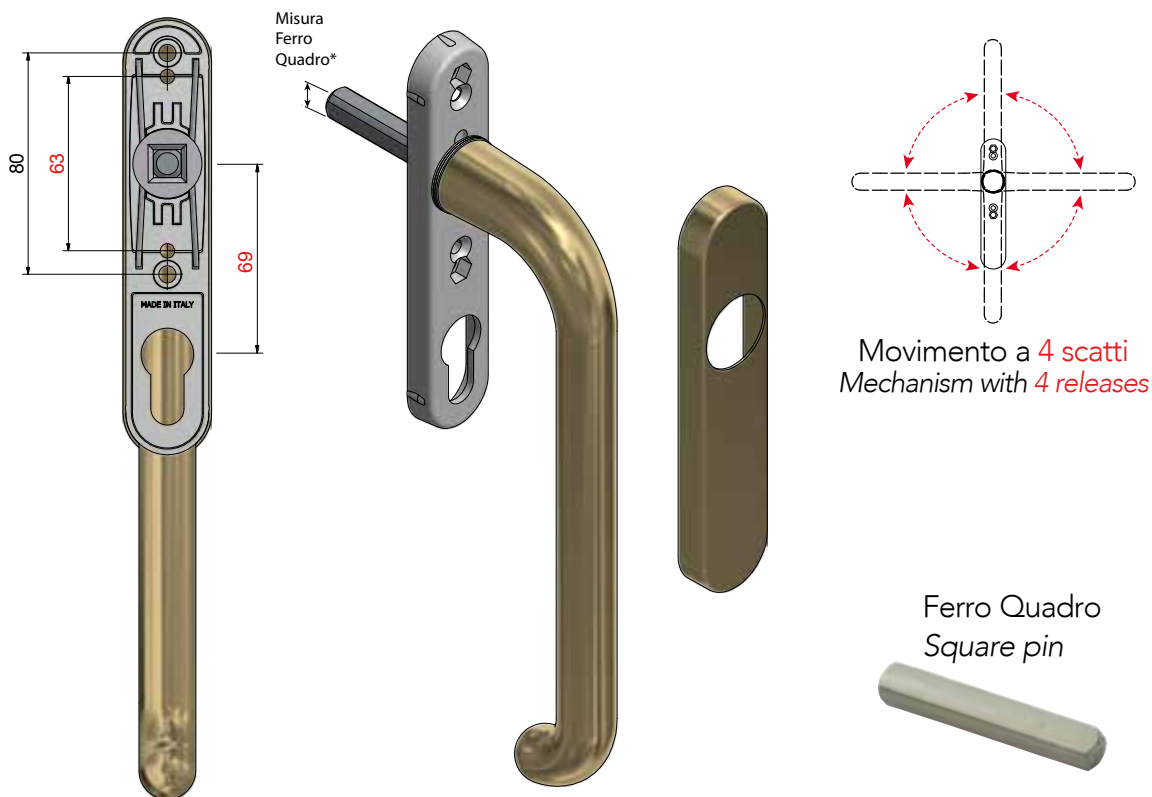

Vantaggi:

- 1- Doppio interasse 80 mm e 63 mm
- 2- Movimento a 4 Scatti
- 3- Possibilita di fornire con ferro $\varnothing 7 - \varnothing 8$ o $\varnothing 10$

The advantages:

- 1- Double center distance 80 mm and 63mm
- 2- Mechanism with 4 releases
- 3- Square pin $\varnothing 7 - \varnothing 8$ or $\varnothing 10$

*A richiesta possibilita di fornire con ferro $\varnothing 7 - \varnothing 8$ o $\varnothing 10$

*On request possibility to supply square pin $\varnothing 7 - \varnothing 8$ or $\varnothing 10$



Info tecnica per nicchia 063 PI Technical info for 063 PI

A richiesta nicchia 063 PI con fori per viti M5 interasse 63 mm
On request flush pull plate 063 PI with M5 holes through fixing center to center 63 mm

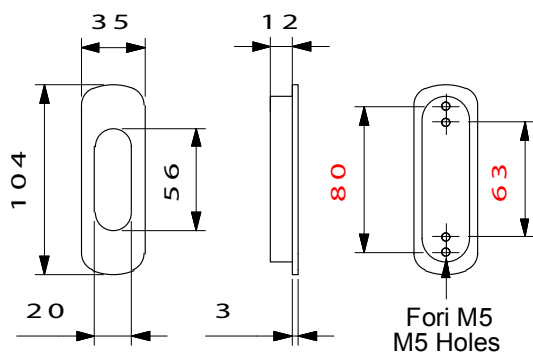
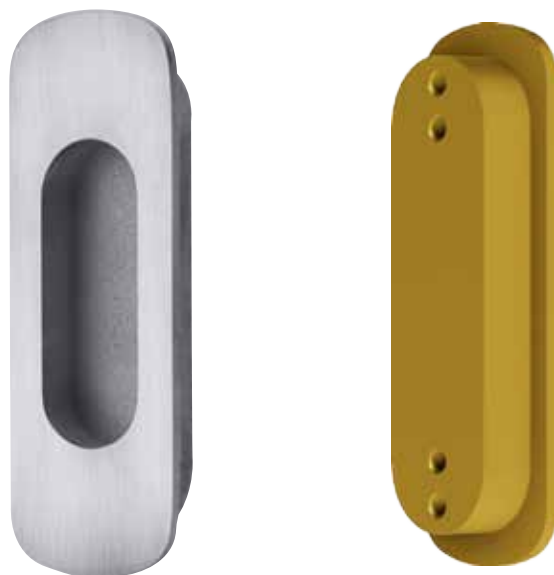

A richiesta nicchia 063 PI
con fori viti M5 interasse 63 mm,
prezzi e quantità da definire.

On request flush pull plate with M5
holes through fixing 63 mm, prices
and quantity to be finalized

Maniglioni Per Sistema Alzante Scorrevole

Pull Handles For Lift And Slide System



313 KT***01-LV



313 KT***11-LV

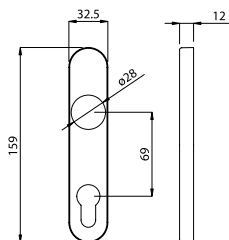

313 PI 002-LV

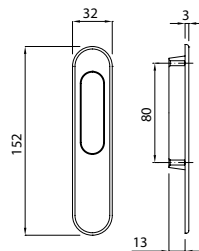

Fresatura /milling

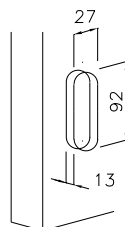

Q13KT***01-OSC



Q13KT***11-OSC

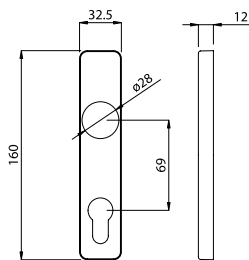

Q13PI002-OSC

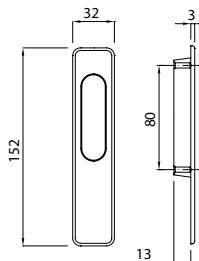

VERSIONI / VERSIONS



Finiture
Finishes

ACCESSORI VARI PER ALZANTI

		LV OS	BG VBN	LR NR	OC NR	AN BGO	PVD	PVD INOX	AGV	INOX SAT	
313 PI 002	Nicchia per maniglione a scatto cieca Flush pull plate	•	•	•	•	•	•	•	•	•	4
313 KT***01	Placca coprimovimento cieca Plate cover mechanism	•	•	•	•	•	•	•	•	•	
313 KT***11	Placca coprimovimento con foro yale dist.69 Plate cover mechanism with europrofile cylinder hole d.69	•	•	•	•	•	•	•	•	•	
		LV			OSC OC						
Q13 PI 002	Nicchia quadra per maniglione a scatto cieca Square Flush pull plate	•			•						4
Q13KT***01	Placca quadra coprimovimento cieca Square Plate cover mechanism	•			•						
Q13KT***11	Placca quadra coprimovimento con foro yale dist.69 Square Plate cover mechanism with europrofile cylinder hole d.69	•			•						

A richiesta maniglione con impugnatura RIBASSATA a 50 mm



B35 MD Q11 OSC



B36 MD Q11 OSC

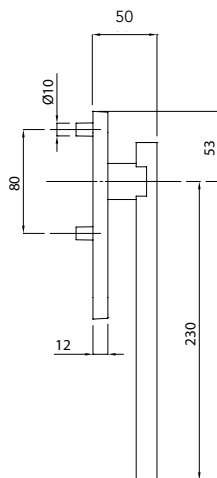

B35 MD

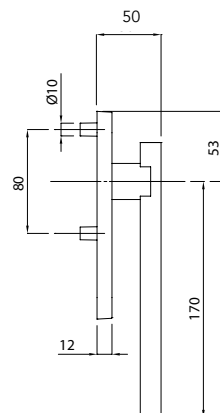

B36 MD

Imballo Packaging



Scatola singola studiata appositamente per mantenere l'articolo integro e ben protetto prima del montaggio sul serramento.

Packaging properly designed to protect the item till the mounting on the door.

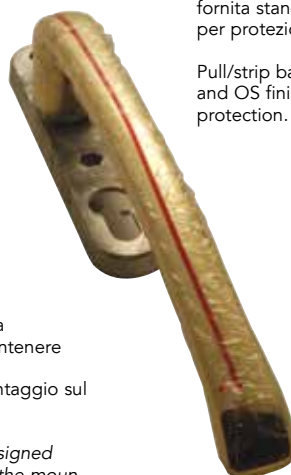

Pellicola protettiva con Strip fornita standard su finiture LV e OS per protezione verniciatura.

Pull/strip bag supplied with LV and OS finishes for lacquer protection.

art. 124 Q-ARTE

design: Studio Reguitti
materiale: Ottone
material: Solid Brass

Brass Class
100% Ottone

MOVIMENTO IN METALLO



124MDQ01-OSC

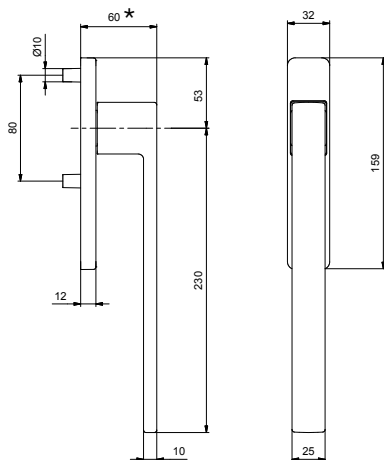

*A richiesta maniglione con impugnatura (art. B24) **RIBASSATA A 50mm**, extra

ESEMPI DI APPLICAZIONE



124 MD Q01



124 MD Q00



124 MD Q10



124 MD Q11



124 LD Q00

VERSIONI / VERSIONS



Finiture
Finishes

MANIGLIONE SINGOLO PER INFISSI ALZANTI E SCORREVOLI / SINGLE PULL HANDLE FOR SLIDING DOORS

		OSC OC	SNV	
124 MD Q01	Maniglione Singolo con placca cieca e con nicchia <i>Single Pull Handle on blind plate with flush pull plate</i>	•	•	1
124 MD Q00	Maniglione Singolo con placca yale senza nicchia <i>Single Pull Handle on yale plate without flush pull plate</i>	•	•	1
124 MD Q10	Maniglione Singolo con placca yale e con nicchia <i>Single Pull Handle on yale plate with flush pull plate</i>	•	•	1
124 MD Q11	Maniglione Singolo con placca cieca senza nicchia <i>Single Pull Handle on blind plate without flush pull plate</i>	•	•	1

COPPIA MANIGLIONI PER INFISSI ALZANTI E SCORREVOLI / PAIR PULL HANDLE FOR SLIDING DOORS

124 LD Q00	Coppia Maniglioni con placca yale <i>Pair pull Handle on yale plate</i>	•	•	1
------------	--	---	---	---

art. 302 Q-CORTO

design: Studio Reguitti
materiale: Ottone
material: Solid Brass

Brass Class
100% Ottone

MOVIMENTO IN METALLO



302MDQ01-OC

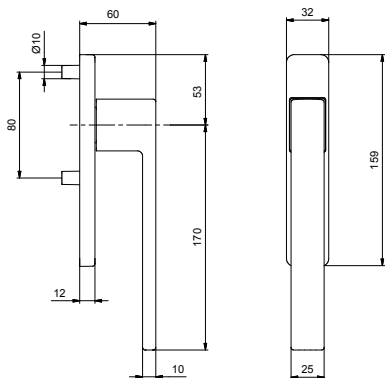

124KT***01
OC



124KT***11
OC

ESEMPI DI APPLICAZIONE



302 MD Q01



302 MD Q00



302 MD Q10



302 MD Q11



302 LD Q00

VERSIONI / VERSIONS



Furniture
Finishes

OSC
OC

SNV



MANIGLIONE SINGOLO PER INFISSI ALZANTI E SCORREVOLI / SINGLE PULL HANDLE FOR SLIDING DOORS

302 MD Q01	Maniglione Singolo con placca cieca e con nicchia Single Pull Handle on blind plate with flush pull plate	•	•	1
302 MD Q00	Maniglione Singolo con placca yale senza nicchia Single Pull Handle on yale plate without flush pull plate	•	•	1
302 MD Q10	Maniglione Singolo con placca yale e con nicchia Single Pull Handle on yale plate with flush pull plate	•	•	1
302 MD Q11	Maniglione Singolo con placca cieca senza nicchia Single Pull Handle on blind plate without flush pull plate	•	•	1

COPPIA MANIGLIONI PER INFISSI ALZANTI E SCORREVOLI / PAIR PULL HANDLE FOR SLIDING DOORS

302 LD Q00	Coppia Maniglioni con placca yale Pair pull Handle on yale plate	•	•	1
------------	---	---	---	---

PLACCA / PLATE

124 KT***01	Placca quadra coprimovimento cieca Square plate cover mechanism	•	•	
124 KT***11	Placca quadra coprimovimento con foro yale dist. 69 Square plate cover mechanism with europrofile cylinder hole d.69	•	•	

art.426 B-ARTE

design: Studio Reguitti
 materiale: Ottone
 material: Solid Brass

Brass Class
 100% Ottone

MOVIMENTO IN METALLO

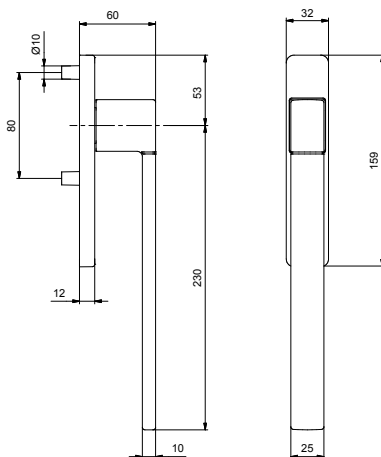

426MDQ01-OSC/OC

ESEMPI DI APPLICAZIONE



426 MD Q01



426 MD Q00



426 MD Q10



426 MD Q11



426 LD Q00

VERSIONI / VERSIONS



Finiture
Finishes

OSC/OC



MANIGLIONE SINGOLO PER INFISSI ALZANTI E SCORREVOLI / SINGLE PULL HANDLE FOR SLIDING DOORS

426 MD Q01	Maniglione Singolo con placca cieca e con nicchia Single Pull Handle on blind plate with flush pull plate	•	1
426 MD Q00	Maniglione Singolo con placca yale senza nicchia Single Pull Handle on yale plate without flush pull plate	•	1
426 MD Q10	Maniglione Singolo con placca yale e con nicchia Single Pull Handle on yale plate with flush pull plate	•	1
426 MD Q11	Maniglione Singolo con placca cieca senza nicchia Single Pull Handle on blind plate without flush pull plate	•	1

COPPIA MANIGLIONI PER INFISSI ALZANTI E SCORREVOLI / PAIR PULL HANDLE FOR SLIDING DOORS

426 LD Q00	Coppia Maniglioni con placca yale Pair pull Handle on yale plate	•	1
------------	---	---	---

art. 303 B-CORTO

design: Studio Reguitti
materiale: Ottone
material: Solid Brass

Brass Class
100% Ottone

MOVIMENTO IN METALLO

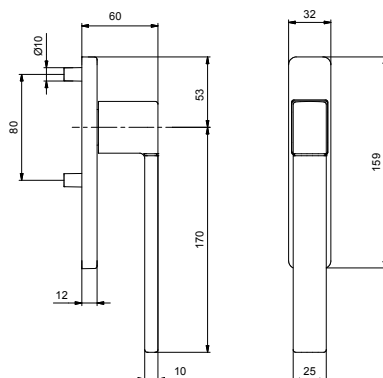

303MDQ01-OSC/OC

ESEMPI DI APPLICAZIONE



303 MD Q01



303 MD Q00



303 MD Q10



303 MD Q11



303 LD Q00

VERSIONI / VERSIONS



Finiture
Finishes

MANIGLIONE SINGOLO PER INFISSI ALZANTI E SCORREVOLI / SINGLE PULL HANDLE FOR SLIDING DOORS

Model	Description	OSC/OC	Quantity
303 MD Q01	Maniglione Singolo con placca cieca e con nicchia Single Pull Handle on blind plate with flush pull plate	•	1
303 MD Q00	Maniglione Singolo con placca yale senza nicchia Single Pull Handle on yale plate without flush pull plate	•	1
303 MD Q10	Maniglione Singolo con placca yale e con nicchia Single Pull Handle on yale plate with flush pull plate	•	1
303 MD Q11	Maniglione Singolo con placca cieca senza nicchia Single Pull Handle on blind plate without flush pull plate	•	1

COPPIA MANIGLIONI PER INFISSI ALZANTI E SCORREVOLI / PAIR PULL HANDLE FOR SLIDING DOORS

303 LD Q00	Coppia Maniglioni con placca yale Pair pull Handle on yale plate	•	1
------------	---	---	---

art. J04 BAUHAUS

design: Studio Reguitti
 materiale: Ottone
 material: Solid Brass

Brass Class
 100% Ottone

MOVIMENTO IN METALLO



J04 MD Q01 OSC



J04 MD Q01 OC

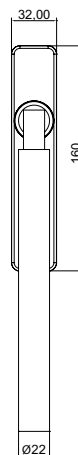
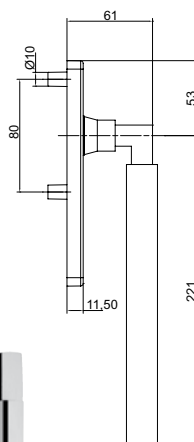

ESEMPI DI APPLICAZIONE



J04 MD Q01



J04 MD Q00



J04 MD Q10



J04 MD Q11



J04 LD Q00

VERSIONI / VERSIONS



Finiture
 Finishes

		LV	OSC OC	
MANIGLIONE SINGOLO PER INFISSI ALZANTI E SCORREVOLI / SINGLE PULL HANDLES FOR SLIDING DOORS				
J04 MD Q01	Maniglione Singolo con placca cieca e con nicchia Single Pull Handle on blind plate and flush pull plate	•	•	1
J04 MD Q00	Maniglione Singolo con placca yale, senza nicchia Single Pull Handle on yale plate, without flush pull plate	•	•	1
J04 MD Q10	Maniglione Singolo con placca yale e con nicchia Single Pull Handle on yale plate and with flush pull plate	•	•	1
J04 MD Q11	Maniglione Singolo con placca cieca e senza nicchia Single Pull Handle on blind plate and with flush pull plate	•	•	1
COPPIA MANIGLIONI PER INFISSI ALZANTI E SCORREVOLI / PAIR PULL HANDLE FOR SLIDING DOORS				
J04 LD Q00	Coppia Maniglioni con placca yale, senza nicchia Pair Pull Handle on yale plate, without flush pull plate	•	•	1

art. 171 ALISE'

design: Studio Reguitti
materiale: Ottone
material: Solid Brass

Brass Class
100% Ottone

MOVIMENTO IN METALLO

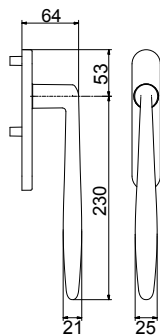

171 MD 001 - OSC

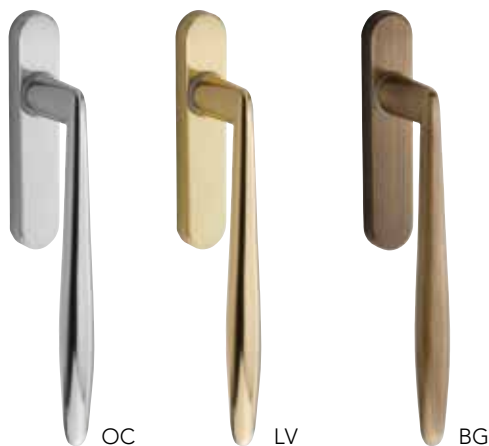

OC

LV

BG

ESEMPI DI APPLICAZIONE



171 MD 001



171 MD 000



171 MD 010



171 MD 011



171 LD 000

VERSIONI / VERSIONS



Finiture
Finishes

LV
BG

OC
OSC

PVD



COPPIA MANIGLIONI PER INFISSI ALZANTI SCORREVOLI / PAIR PULL HANDLE FOR SLIDING DOORS

171 LD 000

Coppia Maniglioni con placca yale
Pair pull handle on plate yale

€

€

€

1

MANIGLIONE SINGOLO PER INFISSI ALZANTI SCORREVOLI / SINGLE PULL HANDLE FOR SLIDING DOORS

171 MD 000

Maniglione singolo con placca yale e senza nicchia
Single pull handle on yale plate without flush pull plate

€

€

€

1

171 MD 001

Maniglione singolo con placca cieca e con nicchia
Single pull handle on blind plate and flush pull plate

€

€

€

1

171 MD 010

Maniglione singolo con placca yale e con nicchia
Single pull handle on yale plate and flush pull plate

€

€

€

1

171 MD 011

Maniglione singolo con placca yale e senza nicchia
Single pull handle on yale plate without flush pull plate

€

€

€

1

art. 173 SASHA

design: Studio Reguitti
 materiale: Ottone
 material: Solid Brass

Brass Class
 100% Ottone

MOVIMENTO IN METALLO

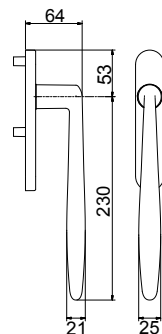

173 MD 001 - OSC/OC



OS/LV

ESEMPI DI APPLICAZIONE



173 MD 001



173 MD 000



173 MD 010



173 MD 011



173 LD 000

VERSIONI / VERSIONS



Finiture
 Finishes

OS/LV

OSC/OC



COPPIA MANIGLIONI PER INFISSI ALZANTI SCORREVOLI / PAIR PULL HANDLE FOR SLIDING DOORS

173 LD 000

Coppia Maniglioni con placca yale
 Pair pull handle on plate yale

€

€

1

MANIGLIONE SINGOLO PER INFISSI ALZANTI SCORREVOLI / SINGLE PULL HANDLE FOR SLIDING DOORS

173 MD 000

Maniglione singolo con placca yale e senza nicchia
 Single pull handle on yale plate without flush pull plate

€

€

1

173 MD 001

Maniglione singolo con placca cieca e con nicchia
 Single pull handle on blind plate and flush pull plate

€

€

1

173 MD 010

Maniglione singolo con placca yale e con nicchia
 Single pull handle on yale plate and flush pull plate

€

€

1

173 MD 011

Maniglione singolo con placca yale e senza nicchia
 Single pull handle on yale plate without flush pull plate

€

€

1

art. 313 PRIAMO

design: Marco Pialorsi
 materiale: Ottone
 material: Solid Brass

Brass Class
 100% Ottone

MOVIMENTO IN METALLO



313 MD 001 LV

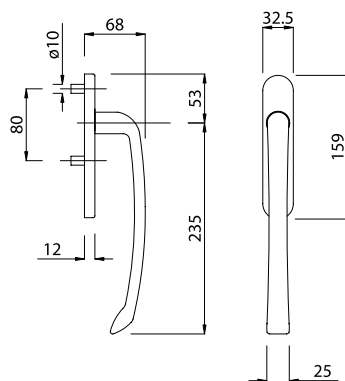

OC



OSC



BG

ESEMPI DI APPLICAZIONE



313 MD 001



313 MD 000



313 MD 010



313 MD 011



313 LD 000

VERSIONI / VERSIONS



MANIGLIONE SINGOLO PER INFISSI ALZANTI E SCORREVOLI / SINGLE PULL HANDLES FOR SLIDING DOORS		LV OS	BG VBN	LR VBN	OC OSC	AN BGO	AGV	PVD	RX	
313 MD 001	Maniglione Singolo con placca cieca e con nicchia Single Pull Handle on blind plate and flush pull plate	•	•	•	•	•	•	•	•	1
313 MD 000	Maniglione Singolo con placca yale, senza nicchia Single Pull Handle on yale plate, without flush pull plate	•			•	•	•	•	•	1
313 MD 010	Maniglione Singolo con placca yale e con nicchia Single Pull Handle on yale plate and with flush pull plate	•	•	•	•	•	•	•	•	1
313 MD 011	Maniglione Singolo con placca cieca e senza nicchia Single Pull Handle on blind plate and with flush pull plate	•			•	•	•	•	•	1
COPPIA MANIGLIONI PER INFISSI ALZANTI E SCORREVOLI / PAIR PULL HANDLE FOR SLIDING DOORS										
313 LD 000	Coppia Maniglioni con placca yale, senza nicchia Pair Pull Handle on yale plate, without flush pull plate	•			•	•	•	•	•	1

art. 311 SHORT

design: Marco Pialorsi
 materiale: Ottone
 material: Solid Brass

Brass Class
 100% Ottone

MOVIMENTO IN METALLO

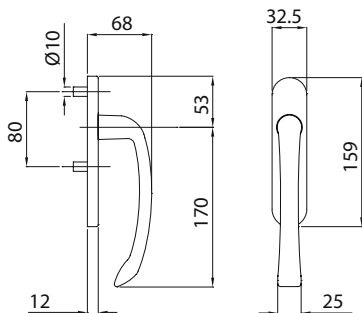

311 MD 001 LV



BG



OC



OSC



VBN

ESEMPI DI APPLICAZIONE



311 MD 001



311 MD 000



311 MD 010



311 MD 011



311 LD 000

VERSIONI / VERSIONS



VERSIONI / VERSIONS		LV OS	BG VBN	LR NR	OC NR	OSC NR	AN BGO	AGV	PVD	PVD INOX	
MANIGLIONE SINGOLO PER INFISSI ALZANTI E SCORREVOLI / SINGLE PULL HANDLES FOR SLIDING DOORS											
311 MD 001	Maniglione Singolo con placca cieca e con nicchia Single Pull Handle on blind plate and flush pull plate	•	•	•	•	•	•	•	•	•	1
311 MD 000	Maniglione Singolo con placca yale e senza nicchia Single Pull Handle on yale plate and without flush pull plate	•	•	•	•	•	•	•	•	•	1
311 MD 010	Maniglione Singolo con placca yale e con nicchia Single Pull Handle on yale plate and with flush pull plate	•	•	•	•	•	•	•	•	•	1
311 MD 011	Maniglione Singolo con placca cieca e senza nicchia Single Pull Handle on blind plate and with flush pull plate	•	•	•	•	•	•	•	•	•	1
COPPIA MANIGLIONI PER INFISSI ALZANTI E SCORREVOLI / PAIR PULL HANDLE FOR SLIDING DOORS											
311 LD 000	Coppia Maniglioni con placca yale Pair Pull Handle on yale plate	•	•	•	•	•	•	•	•	•	1

art. 313 PRIAMO Q

materiale: Ottone
material: Solid Brass

Brass Class
100% Ottone

MOVIMENTO IN METALLO



313 MD Q01 OSC



LV

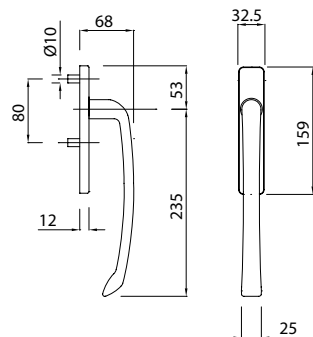

ESEMPI DI APPLICAZIONE



313 MD Q01



313 MD Q00



313 MD Q10



313 MD Q11



313 LD Q00

VERSIONI / VERSIONS



VERSIONI / VERSIONS		LV	OSC OC	
MANIGLIONE SINGOLO PER INFISSI ALZANTI E SCORREVOLI / SINGLE PULL HANDLES FOR SLIDING DOORS				
313 MD Q01	Maniglione Singolo con placca cieca e con nicchia Single Pull Handle on blind plate and flush pull plate	•	•	1
313 MD Q00	Maniglione Singolo con placca yale, senza nicchia Single Pull Handle on yale plate, without flush pull plate	•	•	1
313 MD Q10	Maniglione Singolo con placca yale e con nicchia Single Pull Handle on yale plate and with flush pull plate	•	•	1
313 MD Q11	Maniglione Singolo con placca cieca e senza nicchia Single Pull Handle on blind plate and with flush pull plate	•	•	1
COPPIA MANIGLIONI PER INFISSI ALZANTI E SCORREVOLI / PAIR PULL HANDLE FOR SLIDING DOORS				
313 LD Q00	Coppia Maniglioni con placca yale, senza nicchia Pair Pull Handle on yale plate, without flush pull plate	•	•	1

art. 311 SHORT Q

materiale: Ottone
material: Solid Brass

Brass Class
100% Ottone

MOVIMENTO IN METALLO



311 MD Q01 OSC



LV

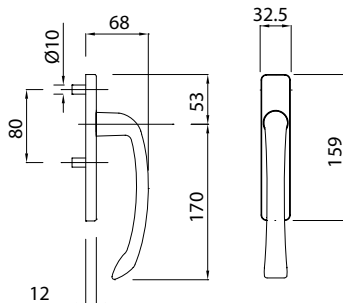

ESEMPI DI APPLICAZIONE



311 MD Q01



311 MD Q00



311 MD Q10



311 MD Q11



311 LD Q00

VERSIONI / VERSIONS



Finiture
Finishes

VERSIONI / VERSIONS		LV	OSC OC	
MANIGLIONE SINGOLO PER INFISSI ALZANTI E SCORREVOLI / SINGLE PULL HANDLES FOR SLIDING DOORS				
311 MD Q01	Maniglione Singolo con placca cieca e con nicchia Single Pull Handle on blind plate and flush pull plate	•	•	1
311 MD Q00	Maniglione Singolo con placca yale e senza nicchia Single Pull Handle on yale plate and without flush pull plate	•	•	1
311 MD Q10	Maniglione Singolo con placca yale e con nicchia Single Pull Handle on yale plate and with flush pull plate	•	•	1
311 MD Q11	Maniglione Singolo con placca cieca e senza nicchia Single Pull Handle on blind plate and with flush pull plate	•	•	1
COPPIA MANIGLIONI PER INFISSI ALZANTI E SCORREVOLI / PAIR PULL HANDLE FOR SLIDING DOORS				
311 LD Q00	Coppia Maniglioni con placca yale Pair Pull Handle on yale plate	•	•	1

art. 30 ENEA

materiale: Ottone
material: Solid Brass

Brass Class
100% Ottone

MOVIMENTO IN METALLO

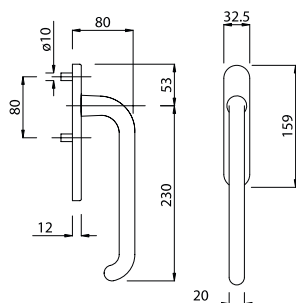

30 MD 001 LV



OSC



BG



AN



ESEMPI DI APPLICAZIONE



30 MD 001



30 MD 000



30 MD 010



30 MD 011



30 LD 000

VERSIONI / VERSIONS



Finiture
Finishes

MANIGLIONE SINGOLO PER INFISSI ALZANTI E SCORREVOLI / SINGLE PULL HANDLES FOR SLIDING DOORS

		LV OS	BG VBN	LR NR	OC NR	OSC NR	AN BGO	AGV	PVD	
30 MD 001	Maniglione Singolo con placca cieca e con nicchia Single Pull Handle on blind plate and flush pull plate	•	•	•	•	•	•	•	•	1
30 MD 000	Maniglione Singolo con placca yale, senza nicchia Single Pull Handle on yale plate, without flush pull plate	•		•	•	•	•	•	•	1
30 MD 010	Maniglione Singolo con placca yale e con nicchia Single Pull Handle on yale plate and with flush pull plate	•	•	•	•	•	•	•	•	1
30 MD 011	Maniglione Singolo con placca cieca e senza nicchia Single Pull Handle on blind plate and with flush pull plate	•		•	•	•	•	•	•	1
COPPIA MANIGLIONI PER INFISSI ALZANTI E SCORREVOLI / PAIR PULL HANDLE FOR SLIDING DOORS										
30 LD 000	Coppia Maniglioni con placca yale, senza nicchia Pair Pull Handle on yale plate, without flush pull plate	•		•	•	•	•	•	•	1

art. 308 EL CORTO

design: Studio Reguitti
materiale: Ottone
material: Solid Brass

Brass Class
100% Ottone

MOVIMENTO IN METALLO

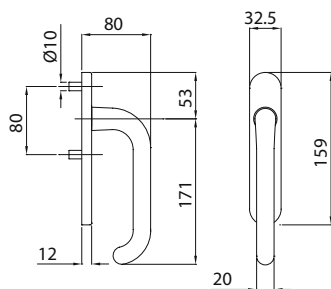

308 MD 001 LV



BG

AN

OSC

ESEMPI DI APPLICAZIONE



308 MD 001

308 MD 000

308 MD 010

308 MD 011

308 LD 000

VERSIONI / VERSIONS



Finiture
Finishes

MANIGLIONE SINGOLO PER INFISSI ALZANTI E SCORREVOLI / SINGLE PULL HANDLES FOR SLIDING DOORS

	LV OS	BG VBN	LR NR	OC NR	OSC BGO	AN BGO	AGV	PVD	PVD INOX	
308 MD 001 Maniglione Singolo con placca cieca e con nicchia Single Pull Handle on blind plate and flush pull plate	•	•	•	•	•	•	•	•	•	1
308 MD 000 Maniglione Singolo con placca yale e senza nicchia Single Pull Handle on yale plate and without flush pull plate	•	•	•	•	•	•	•	•	•	1
308 MD 010 Maniglione Singolo con placca yale e con nicchia Single Pull Handle on yale plate and with flush pull plate	•	•	•	•	•	•	•	•	•	1
308 MD 011 Maniglione Singolo con placca cieca e senza nicchia Single Pull Handle on blind plate and with flush pull plate	•	•	•	•	•	•	•	•	•	1

COPPIA MANIGLIONI PER INFISSI ALZANTI E SCORREVOLI / PAIR PULL HANDLE FOR SLIDING DOORS

308 LD 000 Coppia Maniglioni con placca yale Pair Pull Handle on plate yale	•	•	•	•	•	•	•	•	•	1
---	---	---	---	---	---	---	---	---	---	---

art. 305 LASER

design: Studio Reguitti
 materiale: Ottone
 material: Solid Brass

Brass Class
 100% Ottone

MOVIMENTO IN METALLO



305 MD 001 OSC



LV

OC

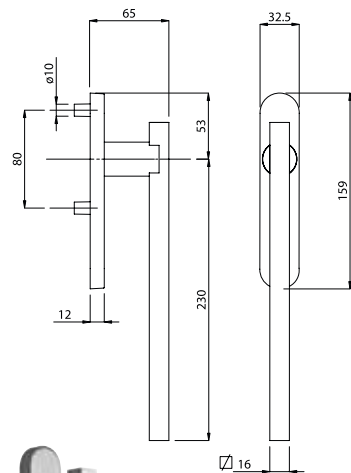

ESEMPI DI APPLICAZIONE



305 MD 001



305 MD 000



305 MD 010



305 MD 011



305 LD 000

VERSIONI / VERSIONS



VERSIONI / VERSIONS		LV	OSC OC	
MANIGLIONE SINGOLO PER INFISSI ALZANTI E SCORREVOLI / SINGLE PULL HANDLES FOR SLIDING DOORS				
305 MD 001	Maniglione Singolo con placca cieca e con nicchia Single Pull Handle on blind plate and flush pull plate	•	•	1
305 MD 000	Maniglione Singolo con placca yale e senza nicchia Single Pull Handle on yale plate and without flush pull plate	•	•	1
305 MD 010	Maniglione Singolo con placca yale e con nicchia Single Pull Handle on yale plate and with flush pull plate	•	•	1
305 MD 011	Maniglione Singolo con placca cieca e senza nicchia Single Pull Handle on blind plate and with flush pull plate	•	•	1
COPPIA MANIGLIONI PER INFISSI ALZANTI E SCORREVOLI / PAIR PULL HANDLE FOR SLIDING DOORS				
305 LD 000	Coppia Maniglioni con placca yale Pair Pull Handle on yale plate	•	•	1

art. 306 LASER CORTO

design: Studio Reguitti
 materiale: Ottone
 material: Solid Brass

Brass Class
 100% Ottone

MOVIMENTO IN METALLO



306 MD 001 OSC



LV

OC

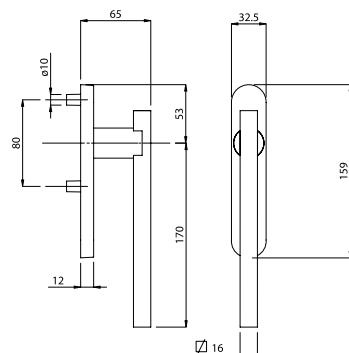

ESEMPI DI APPLICAZIONE



306 MD 001



306 MD 000



306 MD 010



306 MD 011

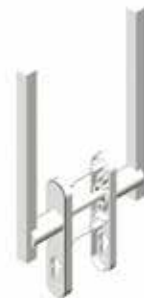

306 LD 000

VERSIONI / VERSIONS



Finire
 Finishes

MANIGLIONE SINGOLO PER INFESSI ALZANTI E SCORREVOLI / SINGLE PULL HANDLES FOR SLIDING DOORS

		LV	OSC OC	
306 MD 001	Maniglione Singolo con placca cieca e con nicchia Single Pull Handle on blind plate and flush pull plate	•	•	1
306 MD 000	Maniglione Singolo con placca yale e senza nicchia Single Pull Handle on yale plate and without flush pull plate	•	•	1
306 MD 010	Maniglione Singolo con placca yale e con nicchia Single Pull Handle on yale plate and with flush pull plate	•	•	1
306 MD 011	Maniglione Singolo con placca cieca e senza nicchia Single Pull Handle on blind plate and with flush pull plate	•	•	1
COPPIA MANIGLIONI PER INFESSI ALZANTI E SCORREVOLI / PAIR PULL HANDLE FOR SLIDING DOORS				
306 LD 000	Coppia Maniglioni con placca yale Pair Pull Handle on yale plate	•	•	1

art. 305 LASER Q

design: Studio Reguitti
 materiale: Ottone
 material: Solid Brass

Brass Class
 100% Ottone

MOVIMENTO IN METALLO



305 MD Q01 OSC

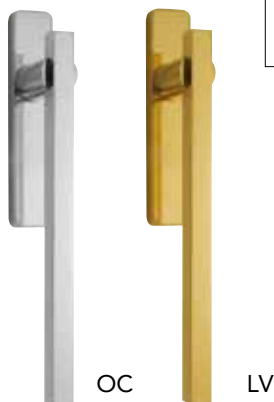

OC

LV

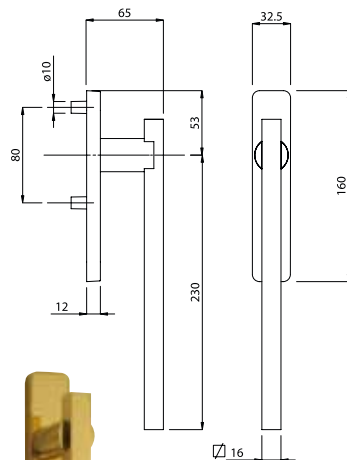

ESEMPI DI APPLICAZIONE



305 MD Q01



305 MD Q00



305 MD Q10



305 MD Q11



305 LD Q00

VERSIONI / VERSIONS



Finestre
 Finishes

MANIGLIONE SINGOLO PER INFESSI ALZANTI E SCORREVOLI / SINGLE PULL HANDLES FOR SLIDING DOORS

		LV	OSC OC	
305 MD Q01	Maniglione Singolo con placca cieca e con nicchia Single Pull Handle on blind plate and flush pull plate	•	•	1
305 MD Q00	Maniglione Singolo con placca yale e senza nicchia Single Pull Handle on yale plate and without flush pull plate	•	•	1
305 MD Q10	Maniglione Singolo con placca yale e con nicchia Single Pull Handle on yale plate and with flush pull plate	•	•	1
305 MD Q11	Maniglione Singolo con placca cieca e senza nicchia Single Pull Handle on blind plate and with flush pull plate	•	•	1
COPPIA MANIGLIONI PER INFESSI ALZANTI E SCORREVOLI / PAIR PULL HANDLE FOR SLIDING DOORS				
305 LD Q00	Coppia Maniglioni con placca yale Pair Pull Handle on yale plate	•	•	1

art. 306 LASER Q-CORTO

design: Studio Reguitti
 materiale: Ottone
 material: Solid Brass

Brass Class
 100% Ottone

MOVIMENTO IN METALLO



306 MD Q01 OSC

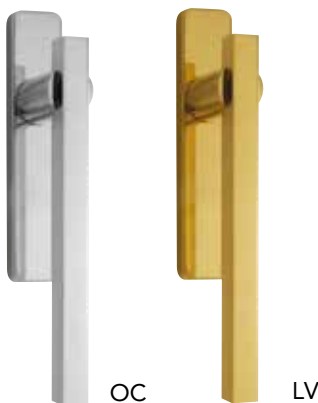

OC

LV

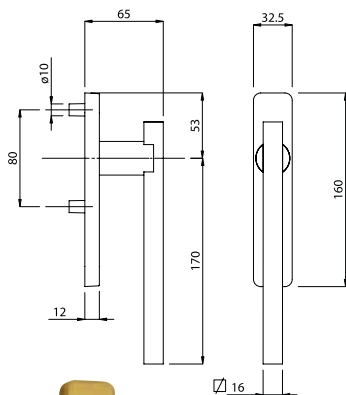

ESEMPLI DI APPLICAZIONE



306 MD Q01



306 MD Q00



306 MD Q10



306 MD Q11



306 LD Q00

VERSIONI / VERSIONS



Finire
 Finishes

		LV	OSC OC	
MANIGLIONE SINGOLO PER INFESSI ALZANTI E SCORREVOLI / SINGLE PULL HANDLES FOR SLIDING DOORS				
306 MD Q01	Maniglione Singolo con placca cieca e con nicchia Single Pull Handle on blind plate and flush pull plate	•	•	1
306 MD Q00	Maniglione Singolo con placca yale e senza nicchia Single Pull Handle on yale plate and without flush pull plate	•	•	1
306 MD Q10	Maniglione Singolo con placca yale e con nicchia Single Pull Handle on yale plate and with flush pull plate	•	•	1
306 MD Q11	Maniglione Singolo con placca cieca e senza nicchia Single Pull Handle on blind plate and with flush pull plate	•	•	1
COPPIA MANIGLIONI PER INFESSI ALZANTI E SCORREVOLI / PAIR PULL HANDLE FOR SLIDING DOORS				
306 LD Q00	Coppia Maniglioni con placca yale Pair Pull Handle on yale plate	•	•	1

art. 175 PUBLIC

design: Marco Pialorsi
 materiale: Ottone
 material: Solid Brass

Brass Class
 100% Ottone

MOVIMENTO IN METALLO



175 MD 001 LV

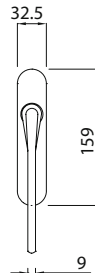
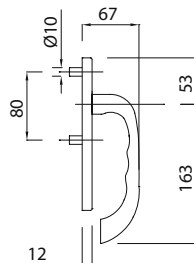
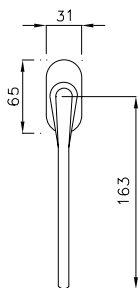

175 DK 015 LV



LV



OC

ESEMPI DI APPLICAZIONE



175 MD 001



175 MD 000



175 MD 010



175 MD 011



175 LD 000

VERSIONI / VERSIONS



Finiture
 Finishes

MANIGLIONE SINGOLO PER INFISSI ALZANTI E SCORREVOLI / SINGLE PULL HANDLES FOR SLIDING DOORS

	LV BG	OC OSC	PVD	
175 MD 001 Maniglione Singolo con placca cieca e con nicchia Single Pull Handle on blind plate and for flush pull plate	•	•	•	1
175 MD 000 Maniglione Singolo con placca yale, senza nicchia Single Pull Handle on yale plate, without flush pull plate	•	•	•	1
175 MD 010 Maniglione Singolo con placca yale e con nicchia Single Pull Handle on yale plate and with flush pull plate	•	•	•	1
175 MD 011 Maniglione Singolo con placca cieca e senza nicchia Single Pull Handle on blind plate and with flush pull plate	•	•	•	1

COPPIA MANIGLIONI PER INFISSI ALZANTI E SCORREVOLI / PAIR PULL HANDLE FOR SLIDING DOORS

175 LD 000 Coppia Maniglioni con placca yale Pair Pull Handle on yale plate	•	•	•	1
---	---	---	---	---

MANIGLIONE DREH KIPP PER COMPLANARE / DREH KIPP PULL HANDLE FOR COPLANAR CLOSURE SLIDING WINDOW

175 DK 015 Maniglione dreh kipp con movimento 4 scatti con bussole q. 7x37 Dreh kipp pull handle with mechanism with 4 releases and bushes q. 7x37	•	•	•	1
--	---	---	---	---

art.307 BERNINI

design: Marco Pialorsi
materiale: Ottone
material: Solid Brass

Brass Class
100% Ottone

MOVIMENTO IN METALLO



307 MD 001 LV

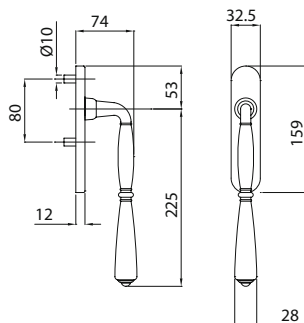

BG

VBN

AGV

AN

ESEMPI DI APPLICAZIONE



307 MD 001



307 MD 000



307 MD 010



307 MD 011



307 LD 000

VERSIONI / VERSIONS



Finiture
Finishes

		LV BG	LR VBN	AN	AGV	
MANIGLIONE SINGOLO PER INFISSI ALZANTI E SCORREVOLI / SINGLE PULL HANDLES FOR SLIDING DOORS						
307 MD 001	Maniglione Singolo con placca cieca e con nicchia Single Pull Handle on blind plate and flush pull plate	•	•	•	•	1
307 MD 000	Maniglione Singolo con placca yale e senza nicchia Single Pull Handle on yale plate and without flush pull plate	•	•	•	•	1
307 MD 010	Maniglione Singolo con placca yale e con nicchia Single Pull Handle on yale plate and with flush pull plate	•	•	•	•	1
307 MD 011	Maniglione Singolo con placca cieca e senza nicchia Single Pull Handle on blind plate and with flush pull plate	•	•	•	•	1
COPPIA MANIGLIONI PER INFISSI ALZANTI E SCORREVOLI / PAIR PULL HANDLE FOR SLIDING DOORS						
307 LD 000	Coppia Maniglioni con placca yale Pair Pull Handle on yale plate	•	•	•	•	1

art. 16 FLORIDA

materiale: Alluminio
material: Aluminium

MOVIMENTO IN METALLO



16 MD 001 AA

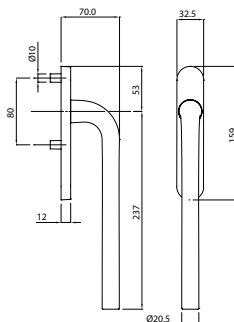

AO



AB



NR



16 MD 001



16 MD 000



16 MD 010



16 MD 011



16 LD 000

VERSIONI / VERSIONS



Finiture
Finishes

MANIGLIONE SINGOLO PER INFISSI ALZANTI E SCORREVOLI / SINGLE PULL HANDLES FOR SLIDING DOORS

		AB BRONZO F4	AA ARGENTO F1	AO ORO F3	NR	
16 MD 001	Maniglione Singolo con placca cieca e con nicchia Single Pull Handle on blind plate and flush pull plate	•	•	•	•	1
16 MD 000	Maniglione Singolo con placca yale, senza nicchia Single Pull Handle on yale plate, without flush pull plate	•	•	•	•	1
16 MD 010	Maniglione Singolo con placca yale e con nicchia Single Pull Handle on yale plate and with flush pull plate	•	•	•	•	1
16 MD 011	Maniglione Singolo con placca cieca e senza nicchia Single Pull Handle on blind plate and with flush pull plate	•	•	•	•	1

COPPIA MANIGLIONI PER INFISSI ALZANTI E SCORREVOLI / PAIR PULL HANDLE FOR SLIDING DOORS

16 LD 000	Coppia Maniglioni con placca yale, senza nicchia Pair Pull Handle on yale plate, without flush pull plate	•	•	•	•	1
-----------	--	---	---	---	---	---

PLACCA / PLATE

313 PI 002	Nicchia per maniglione a scatto cieca Flush pull plate	•	•	•	•	4
313 KT***01	Placca coprimovimento cieca Plate cover mechanism	•	•	•	•	
313 KT***11	Placca coprimovimento con foro yale dist. 69 Plate cover mechanism with europrofile cylinder hole d.69	•	•	•	•	

art. 309 IL BREVE

materiale: Alluminio
material: Aluminium

MOVIMENTO IN METALLO



309 MD 001 AA

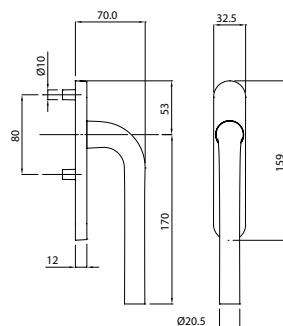

AO



AB



313 PI 002



313KT***01



313KT***11



309 MD 001



309 MD 000



309 MD 010



309 MD 011



309 LD 000

VERSIONI / VERSIONS



Finiture
Finishes

		AB BRONZO F4	AA ARGENTO F1	AO ORO F3	NR	
MANIGLIONE SINGOLO PER INFISSI ALZANTI E SCORREVOLI / SINGLE PULL HANDLES FOR SLIDING DOORS						
309 MD 001	Maniglione Singolo con placca cieca e con nicchia Single Pull Handle on blind plate and flush pull plate	•	•	•	•	1
309 MD 000	Maniglione Singolo con placca yale, senza nicchia Single Pull Handle on yale plate, without flush pull plate	•	•	•	•	1
309 MD 010	Maniglione Singolo con placca yale e con nicchia Single Pull Handle on yale plate and with flush pull plate	•	•	•	•	1
309 MD 011	Maniglione Singolo con placca cieca e senza nicchia Single Pull Handle on blind plate and with flush pull plate	•	•	•	•	1
COPPIA MANIGLIONI PER INFISSI ALZANTI E SCORREVOLI / PAIR PULL HANDLE FOR SLIDING DOORS						
309 LD 000	Coppia Maniglioni con placca yale, senza nicchia Pair Pull Handle on yale plate, without flush pull plate	•	•	•	•	1

art. 30 ACCIAIO INOX / STAINLESS STEEL

materiale: Acciaio Inox
material: Stainless Steel



MOVIMENTO IN METALLO



030 MD 001

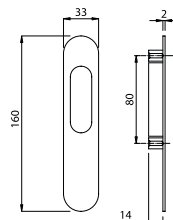
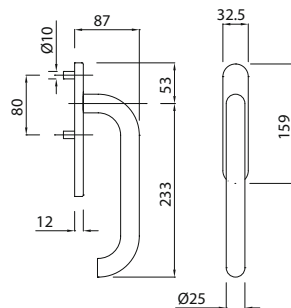

030 PI 002

ESEMPI DI APPLICAZIONE



030 MD 001



030 MD 000



030 MD 010



030 MD 011



030 LD 000

VERSIONI / VERSIONS



Finiture
Finishes

MANIGLIONI PER INFISSI ALZANTI E SCORREVOLI / PULL HANDLES FOR SLIDING DOORS		INOX SAT	
030 MD 001	Maniglione dritto singolo con placca cieca e con nicchia Single pull handle on blind plate and flush pull plate	•	1
030 MD 000	Maniglione dritto singolo con placca yale e senza nicchia Single pull handle on plate with europrofile cylinder hole without flush pull plate	•	1
030 MD 010	Maniglione dritto singolo con placca yale e con nicchia Single pull handle on plate with europrofile cylinder hole without flush pull plate	•	1
030 MD 011	Maniglione dritto singolo con placca cieca e senza nicchia Single pull handle on blind plate without flush pull plate	•	1
030 LD 000	Coppia maniglioni con placca yale Pair pull handle on plate with europrofile cylinder hole	•	1
030 PI 002	Nicchia per maniglione a scatto cieca Flush pull plate	•	4

PORTE HOTEL HOTEL DOORS



209 TP info tecniche

Esempio di applicazione
Mounting example



209 TP-LV



209 TP-OC



209 TP-OSC



VERSIONI / VERSIONS



Finiture
Finishes

LV

OC
OSC



209 TP

Visualizzatore di presenza
Presence Indicator

•

•

24

SISTEMI VITI DI CONNESSIONE PASSANTI/BOLT THROUGH SYSTEM

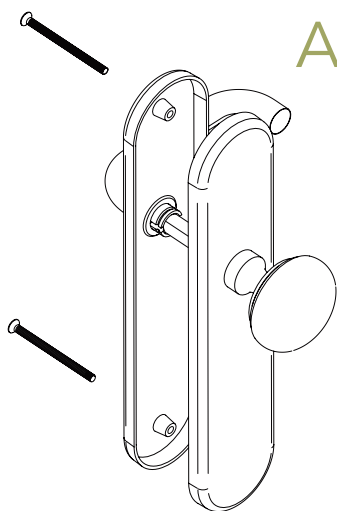

A



viti passanti con placca cieca
e 2 pioli da una parte

B

viti passanti più bussole
cieche normali

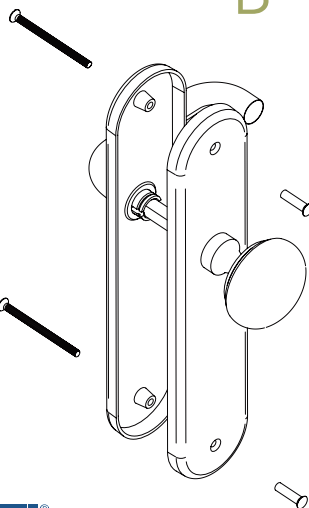

Porta Ingresso



30 PM 056-OSC

Specificare **destro**
o **sinistro** per la
maniglia interna-

Please specify if
inside lever handle
is **right** or **left**



30 PM 356-LV

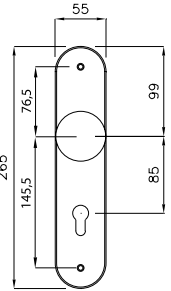

particolare del sistema viti passanti
Bolt through screws system

CON VISUALIZZATORE DI PRESENZA WITH PRESENCE INDICATOR



___ VC 056 ___ VY 056

___ VC 356 ___ VY 356



art. 30-OC



art. 31-OSC



art. 183-PVD

VERSIONI / VERSIONS



Finiture
Finishes

		LV BG	OC OSC	PVD	
30 PM 056	maniglia art. 30 con molla/pomolo art. 56 Ø60 fisso, placca 049 yale, viti passanti lever handle art. 30 with spring/fixed knob art. 56 Ø60, yale plate 049 , passing screws	•	•		1
31 PM 056	maniglia art. 31 con molla/pomolo art. 56 Ø60 fisso, placca 049 yale, viti passanti lever handle art. 31 with spring/fixed knob art. 56 Ø60, yale plate 049 , passing screws	•	•		1
183 PM 056	maniglia art. 183 con molla/pomolo art. 56 Ø60 fisso, placca 049 yale, viti passanti lever handle art. 183 with spring/fixed knob art. 56 Ø60, yale plate 049 , passing screws	•	•	•	1
___ VC 056	extra per guarnitura completa di visualizzatore di presenza secondo standard Cisa extra price for lever handle with presence indicator for Cisa standard	•	•	•	1
___ VY 056	extra per guarnitura completa di visualizzatore di presenza secondo standard Yale extra price for lever handle with presence indicator for Yale standard	•	•	•	1
___ PM 356	extra per guarnitura su placca P49 con bussole filettate senza viti a vista sul lato pomolo (vd. foto 30 PM 356) extra price for fixed knob on P49 plate without screws-holes (see picture 30 PM 356)	•	•	•	1
___ VC 356	extra per guarnitura su placca P49 con bussole filettate completa di visualizzatore di presenza standard Cisa extra price for lever handle with presence indicator for Cisa standard and P49 plate	•	•	•	1
___ VY 356	extra per guarnitura su placca P49 con bussole filettate completa di visualizzatore di presenza standard Yale extra price for lever handle with presence indicator for Yale standard and P49 plate	•	•	•	1

Porta Ingresso



30 PM 058-OSC



30 PM 358-LV

Specificare **destro**
o **sinistro** per la
maniglia interna

Please specify if
inside lever handle
is **right** or **left**

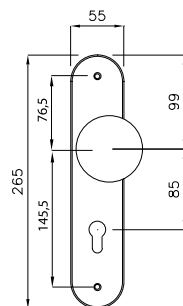

particolare del sistema viti passanti
Bolt through screws system

CON VISUALIZZATORE DI PRESENZA WITH PRESENCE INDICATOR



___ VC 058

___ VY 058

___ VC 358

___ VY 358



art. 30-OC



art. 31-OSC



art. 183-PVD

VERSIONI / VERSIONS



Finiture
Finishes

		LV BG	OC OSC	PVD	
30 PM 058	maniglia art. 30 con molla/pomolo art. 346 fisso, placca 049 yale, viti passanti lever handle art. 30 with spring/fixed knob art. 346, yale plate 049 , passing screws	•	•		1
31 PM 058	maniglia art. 31 con molla/pomolo art. 346 fisso, placca 049 yale, viti passanti lever handle art. 31 with spring/fixed knob art. 346, yale plate 049 , passing screws	•	•		1
183 PM 058	maniglia art. 183 con molla/pomolo art. 346 fisso, placca 049 yale, viti passanti lever handle art. 183 with spring/fixed knob art. 346, yale plate 049 , passing screws	•	•	•	1
___ VC 058	extra per guarnitura completa di visualizzatore di presenza secondo standard Cisa extra price for lever handle with presence indicator for Cisa standard	•	•	•	1
___ VY 058	extra per guarnitura completa di visualizzatore di presenza secondo standard Yale extra price for lever handle with presence indicator for Yale standard	•	•	•	1
___ PM 358	extra per guarnitura su placca P49 con bussole filettate senza viti a vista sul lato pomolo (vd. foto 30 PM 358) extra price for fixed knob on P49 plate without screws-holes (see picture 30 PM 358)	•	•	•	1
___ VC 358	extra per guarnitura su placca P49 con bussole filettate completa di visualizzatore di presenza standard Cisa extra price for lever handle with presence indicator for Cisa standard and P49 plate	•	•	•	1
___ VY 358	extra per guarnitura su placca P49 con bussole filettate completa di visualizzatore di presenza standard Yale extra price for lever handle with presence indicator for Yale standard and P49 plate	•	•	•	1

Porta Ingresso



40 PM 057-LV

40 PM 357-LV

Specificare **destro**
o **sinistro** per la
maniglia interna

Please specify if
inside lever handle
is **right** or **left**

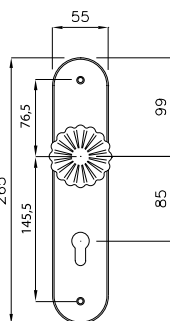

particolare del sistema viti passanti
Bolt through screws system

CON VISUALIZZATORE DI PRESENZA WITH PRESENCE INDICATOR

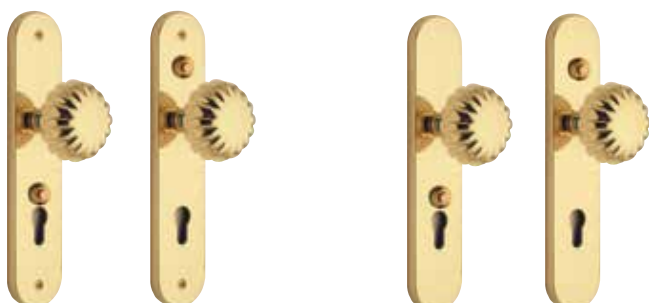

___ VC 057

___ VY 057

___ VC 357

___ VY 357



art. 30-LV

art. 30-BG

art. 40-BG

art. 40-AN

VERSIONI / VERSIONS



Finiture
Finishes

		LV BG	AN	
30 PM 057	maniglia art. 30 con molla/pomolo art. 57 Ø60 fisso, placca 049 yale, viti passanti lever handle art. 30 with spring/fixed knob art. 57 Ø60, yale plate 049 , passing screws	•		1
40 PM 057	maniglia art. 40 con molla/pomolo art. 57 Ø60 fisso, placca 049 yale, viti passanti lever handle art. 40 with spring/fixed knob art. 57 Ø60, yale plate 049 , passing screws	•	•	1
___ VC 057	extra per guarnitura completa di visualizzatore di presenza secondo standard Cisa extra price for lever handle with presence indicator for Cisa standard	•	•	1
___ VY 057	extra per guarnitura completa di visualizzatore di presenza secondo standard Yale extra price for lever handle with presence indicator for Yale standard	•	•	1
___ PM 357	extra per guarnitura su placca P49 con bussole filettate senza viti a vista sul lato pomolo (vd. foto 30 PM 357) extra price for fixed knob on P49 plate without screws-holes (see picture 30 PM 357)	•	•	1
___ VC 357	extra per guarnitura su placca P49 con bussole filettate completa di visualizzatore di presenza standard Cisa extra price for lever handle with presence indicator for Cisa standard and P49 plate	•	•	1
___ VY 357	extra per guarnitura su placca P49 con bussole filettate completa di visualizzatore di presenza standard Yale extra price for lever handle with presence indicator for Yale standard and P49 plate	•	•	1

Porta Ingresso



30 PM 151 LV



30 PM 361 OSC

Specificare **destro**
o **sinistro** per la
maniglia interna

Please specify if
inside lever handle
is **right** or **left**

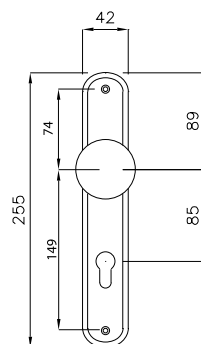

particolare del sistema viti passanti
Bolt through screws system

CON VISUALIZZATORE DI PRESENZA WITH PRESENCE INDICATOR



--- VC 151

--- VY 151



--- VC 361

--- VY 361



art. 30-OC

art. 31-OSC

art. 175-OSC

art. 183-PVD

VERSIONI / VERSIONS



Finiture
Finishes

		LV BG	OC OSC	PVD	
30 PM 151	maniglia art.30 con molla/pomolo art.56 Ø60 fisso, placca 188 yale, viti passanti lever handle art.30 with spring/fixed knob art.56 Ø60, yale plate 188 , passing screws	•	•		1
31 PM 151	maniglia art.31 con molla/pomolo art.56 Ø60 fisso, placca 188 yale, viti passanti lever handle art.31 with spring/fixed knob art.56 Ø60, yale plate 188 , passing screws	•	•		1
175 PM 151	maniglia art.175 con molla/pomolo art.56 Ø60 fisso, placca 188 yale, viti passanti lever handle art.175 with spring/fixed knob art.56 Ø60, yale plate 188 , passing screws	•	•		1
183 PM 151	maniglia art.183 con molla/pomolo art.56 Ø60 fisso, placca 188 yale, viti passanti lever handle art.183 with spring/fixed knob art.56 Ø60, yale plate 188 , passing screws	•	•	•	1
--- VC 151	extra per guarnitura completa di visualizzatore di presenza secondo standard Cisa extra price for lever handle with presence indicator for Cisa standard	•	•	•	1
--- VY 151	extra per guarnitura completa di visualizzatore di presenza secondo standard Yale extra price for lever handle with presence indicator for Yale standard	•	•	•	1
--- PM 361	extra per guarnitura su placca P88 con bussole filettate senza viti a vista sul lato pomolo (vd. foto 30 PM 361) extra price for fixed knob on P88 plate without screws-holes (see picture 30 PM 361)	•	•	•	1
--- VC 361	extra per guarnitura su placca P88 con bussole filettate completa di visualizzatore di presenza standard Cisa extra price for lever handle with presence indicator for Cisa standard and P88 plate	•	•	•	1
--- VY 361	extra per guarnitura su placca P88 con bussole filettate completa di visualizzatore di presenza standard Yale extra price for lever handle with presence indicator for Yale standard and P88 plate	•	•	•	1

Porta Ingresso



destra/right

Specificare **destra** o **sinistra** per la maniglia interna

Please specify if inside lever handle is **right** or **left**

30 PM 153-LV



destra/right

30 PM 363-OSC

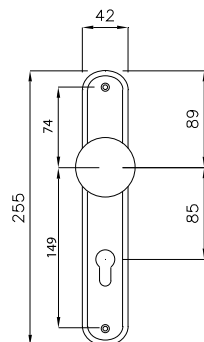

particolare del sistema viti passanti
Bolt through screws system

CON VISUALIZZATORE DI PRESENZA WITH PRESENCE INDICATOR



___VC 153

___VY 153



___VC 363

___VY 363



art. 30-OC

art. 31-OSC

art. 175-OSC

art. 183-LV

VERSIONI / VERSIONS



Finiture
Finishes

		LV BG	OC OSC	
30 PM 153	maniglia art.30 con molla/pomolo art.59 Ø50 fisso, placca 188 yale, viti passanti lever handle art.30 with spring/fixed knob art.59 Ø50, yale plate 188 , passing screws	•	•	1
31 PM 153	maniglia art.31 con molla/pomolo art.59 Ø50 fisso, placca 188 yale, viti passanti lever handle art.31 with spring/fixed knob art.59 Ø50, yale plate 188 , passing screws	•	•	1
175 PM 153	maniglia art.175 con molla/pomolo art.59 Ø50 fisso, placca 188 yale, viti passanti lever handle art.175 with spring/fixed knob art.59 Ø50, yale plate 188 , passing screws	•	•	1
183 PM 153	maniglia art.183 con molla/pomolo art.59 Ø50 fisso, placca 188 yale, viti passanti lever handle art.183 with spring/fixed knob art.59 Ø50, yale plate 188 , passing screws	•	•	1
___VC 153	extra per guarnitura completa di visualizzatore di presenza secondo standard Cisa extra price for lever handle with presence indicator for Cisa standard	•	•	1
___VY 153	extra per guarnitura completa di visualizzatore di presenza secondo standard Yale extra price for lever handle with presence indicator for Yale standard	•	•	1
___PM 363	extra per guarnitura su placca P88 con bussole filettate senza viti a vista sul lato pomolo (vd. foto 30 PM 363) extra price for fixed knob on P88 plate without screws-holes (see picture 30 PM 363)	•	•	1
___VC 363	extra per guarnitura su placca P88 con bussole filettate completa di visualizzatore di presenza standard Cisa extra price for lever handle with presence indicator for Cisa standard and P88 plate	•	•	1
___VY 363	extra per guarnitura su placca P88 con bussole filettate completa di visualizzatore di presenza standard Yale extra price for lever handle with presence indicator for Yale standard and P88 plate	•	•	1

Porta Ingresso



destra/right

Specificare **destra**
o **sinistra** per la
maniglia interna

Please specify if
inside lever handle
is **right** or **left**

30 PM 159-LV



destra/right

30 PM 369-OSC

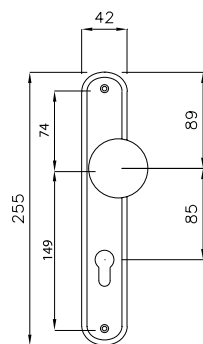

particolare del sistema viti passanti
Bolt through screws system

CON VISUALIZZATORE DI PRESENZA WITH PRESENCE INDICATOR



___ VC 159

___ VY 159



___ VC 369

___ VY 369



art. 30-OC



art. 31-OSC



art. 175-OSC



art. 183-PVD

VERSIONI / VERSIONS



Finiture
Finishes

		LV BG	OC OSC	PVD	
30 PM 159	maniglia art.30 con molla/pomolo art. 345 fisso, placca 188 yale, viti passanti lever handle art.30 with spring/fixed knob art. 345, yale plate 188 , passing screws	•	•		1
31 PM 159	maniglia art.31 con molla/pomolo art. 345 fisso, placca 188 yale, viti passanti lever handle art.31 with spring/fixed knob art. 345, yale plate 188 , passing screws	•	•		1
175 PM 159	maniglia art.175 con molla/pomolo art. 345 fisso, placca 188 yale, viti passanti lever handle art.175with spring/fixed knob art. 345, yale plate 188 , passing screws	•	•		1
183 PM 159	maniglia art.183 con molla/pomolo art. 345 fisso, placca 188 yale, viti passanti lever handle art.183 with spring/fixed knob art. 345, yale plate 188 , passing screws	•	•	•	1
___ VC 159	extra per guarnitura completa di visualizzatore di presenza secondo standard Cisa extra price for lever handle with presence indicator for Cisa standard	•	•	•	1
___ VY 159	extra per guarnitura completa di visualizzatore di presenza secondo standard Yale extra price for lever handle with presence indicator for Yale standard	•	•	•	1
___ PM 369	extra per guarnitura su placca P88 con bussole filettate senza viti a vista sul lato pomolo (vd. foto 30 PM 369) extra price for fixed knob on P88 plate without screws-holes (see picture 30 PM 369)	•	•	•	1
___ VC 369	extra per guarnitura su placca P88 con bussole filettate completa di visualizzatore di presenza standard Cisa extra price for lever handle with presence indicator for Cisa standard and P88 plate	•	•	•	1
___ VY 369	extra per guarnitura su placca P88 con bussole filettate completa di visualizzatore di presenza standard Yale extra price for lever handle with presence indicator for Yale standard and P88 plate	•	•	•	1

Porta Ingresso



030 PM 133-OSC

030 PM 333-OSC

Specificare **destro**
o sinistro per la
maniglia interna

Please specify if
inside lever handle
is **right** or **left**

CON VISUALIZZATORE DI PRESENZA WITH PRESENCE INDICATOR



--- VC 133

--- VY 133

--- VC 333

--- VY 333

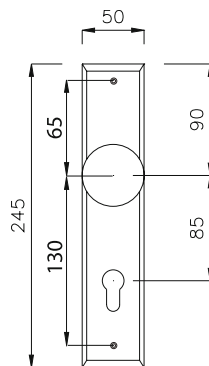

VERSIONI / VERSIONS



Finiture
Finishes

LV

OC
OSC



Version	Description	LV	OC OSC	Box
30 PM 133	maniglia art. 30 con molla/pomolo art. 98 Ø50 fisso, placca 130 yale, viti passanti lever handle art. 30 with spring/fixed knob art. 98 Ø50, yale plate 130 , passing screws	•	•	1
30 PM 333	maniglia art. 30 con placca 130 yale con molla/pomolo art. 98 Ø50 fisso su placca P30 yale, con bussole filettate, senza viti a vista, con viti passanti lever handle art. 30 on yale plate 130 with spring/fixed knob art. 98 Ø50, on yale plate P30 , without hole screws, with passing screws	•	•	1
30 VC 133	maniglia art. 30 con molla/pomolo art. 98 Ø50 fisso su placca 130 yale con viti passanti e con visualizzatore di presenza secondo standard CISA lever handle art. 30 with spring/fixed knob art. 98 Ø50, yale plate 130 , and with presence indicator for CISA standard	•	•	1
30 VY 133	maniglia art. 30 con molla/pomolo art. 98 Ø50 fisso su placca 130 yale con viti passanti e con visualizzatore di presenza secondo standard YALE lever handle art. 30 with spring/fixed knob art. 98 Ø50, yale plate 130 , and with presence indicator for YALE standard	•	•	1
30 VC 333	maniglia art. 30 con placca 130 yale con molla/pomolo art. 98 Ø50 fisso su placca P30 yale con viti passanti con bussole filettate, senza viti a vista, con visualizzatore di presenza secondo standard CISA lever handle art. 30 on yale plate with spring/fixed knob art. 98 Ø50, yale plate P30 , without hole screws and with presence indicator for CISA standard	•	•	1
30 VY 333	maniglia art. 30 con placca 130 yale con molla/pomolo art. 98 Ø50 fisso su placca P30 yale con viti passanti con bussole filettate, senza viti a vista, con visualizzatore di presenza secondo standard YALE lever handle art. 30 on yale plate with spring/fixed knob art. 98 Ø50, yale plate P30 , without hole screws and with presence indicator for YALE standard	•	•	1

Porta Ingresso



CON VISUALIZZATORE DI PRESENZA WITH PRESENCE INDICATOR



VERSIONI / VERSIONS



Finishes
Finishes

		LV	OC OSC	
130 PM 133	maniglia art. 130 con molla/pomolo art.98 Ø50 fisso su placca 130 yale con viti passanti lever handle art. 130 with spring/fixed knob art. 98 Ø50 on yale plate 130 with passing screws	•	•	1
130 PM 333	maniglia art. 130 con placca 130 yale con molla/pomolo art. 98 Ø50 fisso su placca P30 yale, con bussole filettate, senza viti a vista, con viti passanti lever handle art. 130 on yale plate 130 with spring/fixed knob art. 98 Ø50, on yale plate P30 , without hole screws, with passing screws	•	•	1
130 VC 133	maniglia art. 130 con molla/pomolo art.98 Ø50 fisso su placca 130 yale con viti passanti e con visualizzatore di presenza secondo standard CISA lever handle art. 130 with spring/fixed knob art. 98 Ø50, yale plate 130 , and with presence indicator for CISA standard	•	•	1
130 VY 133	maniglia art. 130 con molla/pomolo art.98 Ø50 fisso su placca 130 yale con viti passanti e con visualizzatore di presenza secondo standard YALE lever handle art. 130 with spring/fixed knob art. 98 Ø50, yale plate 130 , and with presence indicator for YALE standard	•	•	1
130 VC 333	maniglia art. 130 con placca 130 yale con molla/pomolo art. 98 Ø50 fisso su placca P30 yale con viti passanti con bussole filettate, senza viti a vista, con visualizzatore di presenza secondo standard CISA lever handle art. 130 on yale plate with with spring/fixed knob art. 98 Ø50, yale plate P30 , without hole screws and with presence indicator for CISA standard	•	•	1
130 VY 333	maniglia art. 130 con placca 130 yale con molla/pomolo art. 98 Ø50 fisso su placca P30 yale con viti passanti con bussole filettate, senza viti a vista, con visualizzatore di presenza secondo standard YALE lever handle art. 130 on yale plate with with spring/fixed knob art. 98 Ø50, yale plate P30 , without hole screws and with presence indicator for YALE standard	•	•	1

Porta Ingresso



128 PM 056-OSC

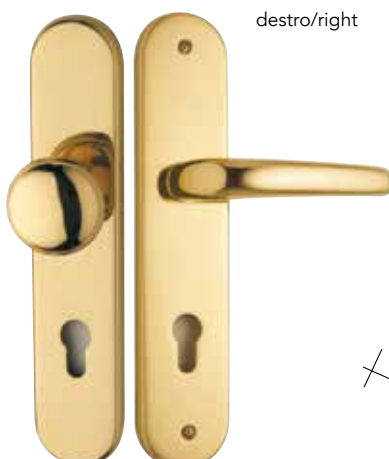

128 PM 356-LV

Specificare **destro**
o **sinistro** per la
maniglia interna

Please specify if
inside lever handle
is **right** or **left**

con maniglia "NORMA"
art. 128



impugnatura a norma
UNI EN 179/2002

CON VISUALIZZATORE DI PRESENZA WITH PRESENCE INDICATOR



--- VC 056 --- VY 056



--- VC 356 --- VY 356

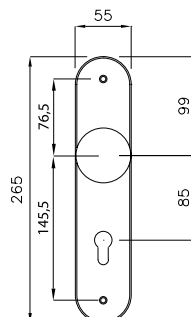

VERSIONI / VERSIONS



Finiture
Finishes

LV OC OSC PVD

128 PM 056	maniglia art. 128 con molla/pomolo art. 56 Ø60 fisso, placca 049 yale, viti passanti lever handle art. 128 with spring/fixed knob art. 56 Ø60, yale plate 049 , passing screws	•	•	•	1
128 PM 356	maniglia art. 128 con placca 049 yale con molla/pomolo art. 56 Ø60 fisso su placca P49 yale, con bussole filettate, senza viti a vista, con viti passanti lever handle art. 128 on yale plate 049 with spring/fixed knob art. 56 Ø60, on yale plate P49 , without hole screws, with passing screws	•	•	•	1
128 VC 056	maniglia art. 128 con molla/pomolo art. 56 Ø60 fisso su placca 049 yale con viti passanti e con visualizzatore di presenza secondo standard CISA lever handle art. 128 with spring/fixed knob art. 56 Ø60, yale plate 049 , and with presence indicator for CISA standard	•	•		1
128 VY 056	maniglia art. 128 con molla/pomolo art. 56 Ø60 fisso su placca 049 yale con viti passanti e con visualizzatore di presenza secondo standard YALE lever handle art. 128 with spring/fixed knob art. 56 Ø60, yale plate 049 , and with presence indicator for YALE standard	•	•		1
128 VC 356	maniglia art. 128 con placca 049 yale con molla/pomolo art. 56 Ø60 fisso su placca P49 yale con viti passanti con bussole filettate, senza viti a vista, con visualizzatore di presenza secondo standard CISA lever handle art. 128 on yale plate 049 with spring/fixed knob art. 56 Ø60, yale plate P49 , without hole screws and with presence indicator for CISA standard	•	•		1
128 VY 356	maniglia art. 128 con placca 049 yale con molla/pomolo art. 56 Ø60 fisso su placca P49 yale con viti passanti con bussole filettate, senza viti a vista, con visualizzatore di presenza secondo standard YALE lever handle art. 128 on yale plate 049 with spring/fixed knob art. 56 Ø60, yale plate P49 , without hole screws and with presence indicator for YALE standard	•	•		1

Porta Ingresso

destro/right



128 PM 151-LV

destro/right



128 PM 361-OSC

Specificare **destro**
o **sinistro** per la
maniglia interna

Please specify if
inside lever handle
is **right** or **left**

con maniglia "NORMA"
art. 128



impugnatura a norma
UNI EN 179/2002

CON VISUALIZZATORE DI PRESENZA WITH PRESENCE INDICATOR



--- VC 151 --- VY 151



--- VC 361 --- VY 361

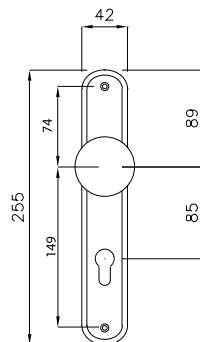

VERSIONI / VERSIONS



Finishes
Finitishes

LV

OC
OSC

PVD



128 PM 151 maniglia art.128 con molla/pomolo art.56 Ø60 fisso, **placca 188** yale, viti passanti
lever handle art.128 with spring/fixed knob art.56 Ø60, **plate 188**, passing screws

128 PM 361 maniglia art.128 con molla/pomolo art.56 Ø60 fisso, **placca P88** yale,
con bussole filettate, senza viti a vista, con viti passanti
lever handle art.128 with spring/fixed knob art.56 Ø60, **plate P88**,
without hole screws, with passing screws

128 VC 151 maniglia art. 128 con molla/pomolo art. 56 Ø60 fisso su **placca 188** yale con viti passanti e
con visualizzatore di presenza secondo standard **CISA**
lever handle art. 128 with spring/fixed knob art. 56 Ø60, **plate 188**, and with presence indicator for
CISA standard

128 VY 151 maniglia art. 128 con molla/pomolo art. 56 Ø60 fisso su **placca 188** yale con viti passanti
e con visualizzatore di presenza secondo standard **YALE**
lever handle art. 128 with spring/fixed knob art. 56 Ø60, **plate 188**, and with presence indicator for
YALE standard

128 VC 361 maniglia art. 128 con con placca 188 yale con molla/pomolo art. 56 Ø60 fisso su **placca P88** yale con viti
passanti con bussole filettate, senza viti a vista, con visualizzatore di presenza secondo standard **CISA**
lever handle art. 128 on yale plate 188 with spring/fixed knob art. 56 Ø60, **plate P88**, without hole
screws and with presence indicator for **CISA** standard

128 VY 361 maniglia art. 128 con con placca 188 yale con molla/pomolo art. 56 Ø60 fisso su **placca P88** yale con viti
passanti con bussole filettate, senza viti a vista, con visualizzatore di presenza secondo standard **YALE**
lever handle art. 128 on yale plate 188 with spring/fixed knob art. 56 Ø60, **plate P88**, without hole
screws and with presence indicator for **YALE** standard

Porta Ingresso

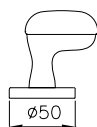
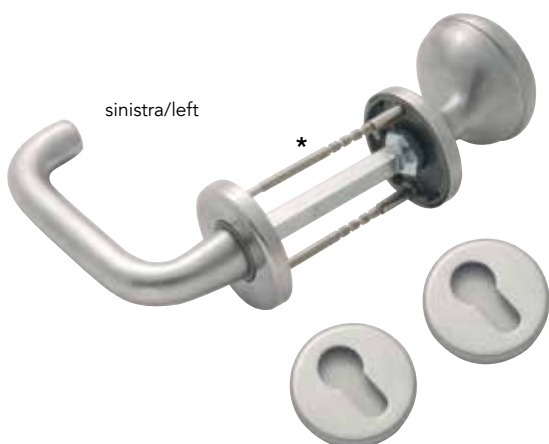

specificare **destra o sinistra**
per la maniglia interna
please specify if inside lever
handle is **right or left**

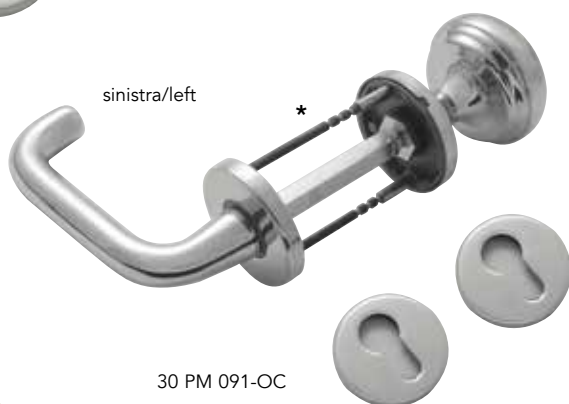

30 PM 091-OC

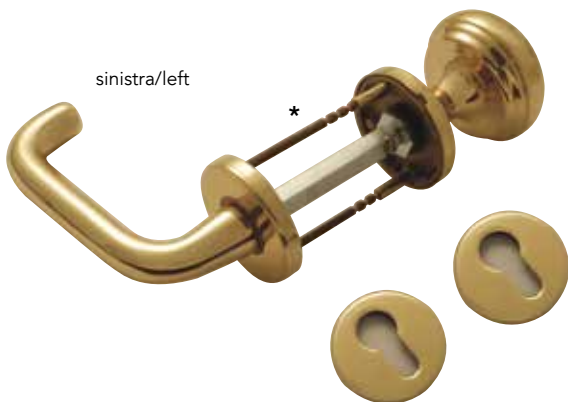

30 PM 091-LV

specificare **destra o sinistra**
per la maniglia interna
please specify if inside lever
handle is **right or left**



* A richiesta con viti e bussole di connessione interasse mm.38 pre-inserite EXTRA PREZZO € 0,34

* On request with pre-inserted bolts through and connection bushes, center to center mm 38, EXTRA PRICE € 0,34



VERSIONI / VERSIONS



Finiture
Finishes

LV
BG

OC
OSC



30 PM 098	maniglia art.30 con rosetta 008, molla e grano, bocchetta yale/pomolo art. 345 fisso su rosetta P08 con ferro F2 con bocchetta yale lever handle art.30 on rose 008 with spring and grub screw with yale key hole/fixed knob art. 345 on rose P08 with F2 spindle and yale key hole	•	•	
30 PM 091	maniglia art.30 con rosetta 008, molla e grano, bocchetta yale/pomolo art. 56 Ø60 fisso su rosetta P08 con ferro F2 con bocchetta yale lever handle art.30 on rose 008 with spring and grub screw with yale key hole/fixed knob art. 56 Ø60 on rose P08 with F2 spindle and yale key hole	•	•	

Porta Ingresso

Specificare Dx o Sx per la maniglia interna
Please specify if inside lever handle is Right or Left



sinistra/left

*

128 PM 091-LV

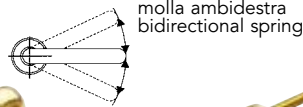
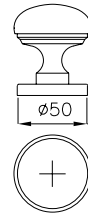

molla ambidestra
bidirectional spring



128 PM 212-LV



molla ambidestra
bidirectional spring

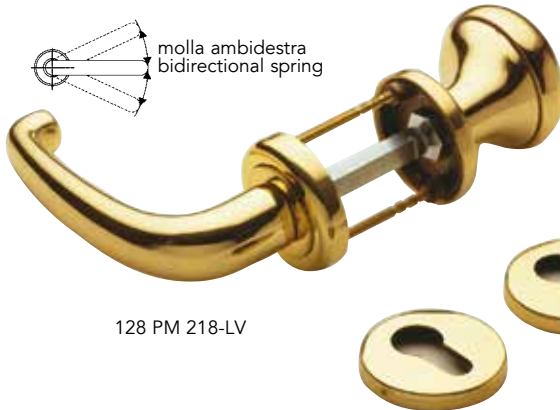

128 PM 218-LV



* A richiesta con viti e bussole di connessione interasse mm.38 pre-inserite EXTRA PREZZO € 0,34

* On request with pre-inserted bolts through and connection bushes, center to center mm 38, EXTRA PRICE € 0,34



VERSIONI / VERSIONS



Finiture
Finishes

		LV BG	OC OSC	PVD	
128 PM 091	maniglia art.128 con rosetta 008, molla e grano, bocchetta yale/pomolo art.56 Ø60 fisso su rosetta P08 con ferro F2 con bocchetta yale lever handle art.128 with rose 008 with spring and grub screw with yale key hole / fixed knob art.56 Ø60 on rose P08 with F2 pin, with yale key hole	•	•	84,96	1
128 PM 212	maniglia art.128 con rosetta 38D con molla ambidestra con bocchetta 008 yale/pomolo art.56 Ø60 fisso su rosetta D06 con bussole fil. M4 con ferro F2 con folle con bocchetta 008 yale e con viti di connessione passanti lever handle art.128 with rose 38D with bidirectional spring with with yale key hole 008 / fixed knob art.56 Ø60 on rose D06 with F2 pin, with bush M4, with yale key hole and with passing screws	•	•		1
128 PM 218	maniglia art.128 con rosetta 38D con molla ambidestra con bocchetta 008 yale/pomolo art.345 fisso su rosetta D06 con bussole fil. M4 con ferro F2 con folle con bocchetta 008 yale e con viti di connessione passanti lever handle art.128 with rose 38D with bidirectional spring with yale key hole 008 / fixed knob art.345 on rose D06 with F2 pin, with bush M4, with yale key hole 008 and with passing screws	•	•		1

Porta Bagno



30 PG 049-LV



30 PW 049-OC



30 PG 188-LV



30 PW 188-OC



30 RG 008-LV

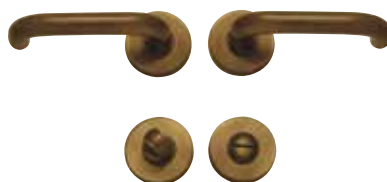

30 RW 008-BG

VERSIONI / VERSIONS



Finiture
Finishes

		LV BG	OC OSC	
30 PG 049	maniglia art. 30 con placca 049 con WC 512 grande con molla e grano lever handle art. 30 on plate 049 with WC turn 512 with spring	•	•	1
30 PW 049	maniglia art. 30 con placca 049 con WC 503 con molla e grano lever handle art. 30 on plate 049 with WC turn 503 with spring	•	•	1
30 PG 188	maniglia art. 30 con placca 188 con WC 512 grande con molla e grano lever handle art. 30 on plate 188 with WC turn 512 with spring	•	•	1
30 PW 188	maniglia art. 30 con placca 188 con WC 503 con molla e grano lever handle art. 30 on plate 188 with WC turn 503 with spring	•	•	1
30 RG 008	maniglia art. 30 con rosetta 008 con WC 512 grande con molla e grano	•	•	1
30 RW 008	maniglia art. 30 con rosetta 008 con WC 503 con molla e grano	•	•	1

Porta Comunicante



30 MP 049-LV yale



30 MP 188-LV yale



30 MR 008-LV yale

Porta Passaggio



30 MP 049-OSC cieca



30 MP 188-OC cieca



30 MR 008-BG

specificare se richiedi le placche con foro **yale** o **cieche**
please specify if the plates are **blind** or with **europrofile** cylinder hole (yale)

VERSIONI / VERSIONS



		LV BG	OC OSC	
30 MP 049	maniglia art. 30 con placca 049 con molla e grano lever handle art. 30 on plate 049 with spring and grub screw	•	•	1
30 MP 049	maniglia art. 30 con placca cieca 049 con molla e grano lever handle art. 30 on blind plate 049 with spring and grub screw	•	•	1
30 MP 188	maniglia art. 30 con placca 188 con molla e grano lever handle art. 30 on plate 188 with spring and grub screw	•	•	1
30 MP 188	maniglia art. 30 con placca cieca 188 con molla e grano lever handle art. 30 on blind plate 188 with spring and grub screw	•	•	1
30 MR 008	maniglia art. 30 con rosetta 008 con bocchetta yale, molla e grano lever handle art. 30 on plate 008 with yale key hole, spring and grub screw	•	•	1
30 MR 008	maniglia art. 30 con rosetta 008 senza bocchetta con molla e grano lever handle art. 30 on plate 008 without rose for key with spring and grub screw	•	•	1

Porta Bagno



128 PG 049-LV



128 PW 049-OSC



128 PG 188-LV



128 PW 188-OC



128 RG 008-LV



128 RW 008-OSC

VERSIONI / VERSIONS



		LV BG	OC OSC	
128 PG 049	maniglia art. 128 con placca 049 con WC 512 grande con molla e grano lever handle art. 128 on plate 049 with WC turn 512 with spring	•	•	1
128 PW 049	maniglia art. 128 con placca 049 con WC 503 con molla e grano lever handle art. 128 on plate 049 with WC turn 503 with spring	•	•	1
128 PG 188	maniglia art. 128 con placca 188 con WC 512 grande con molla e grano lever handle art. 128 on plate 188 with WC turn 512 with spring	•	•	1
128 PW 188	maniglia art. 128 con placca 188 con WC 503 con molla e grano lever handle art. 128 on plate 188 with WC turn 503 with spring	•	•	1
128 RG 008	maniglia art. 128 con rosetta 008 con WC 512 grande con molla e grano lever handle art. 128 on plate 008 with WC turn 512 with spring	•	•	1
128 RW 008	maniglia art. 128 con rosetta 008 con WC 503 con molla e grano lever handle art. 128 on rosetta 008 with WC turn 503 with spring	•	•	1

Porta Comunicante



128 MP 049-LV yale



128 MP 049-OSC cieca



128 MP 188-LV yale



128 MP 188-OSC cieca



128 MR 008-LV yale



128 MR 008-OSC

specificare se richiESTE le placche con foro **yale** o **cieche**
please specify if the plates are **blind** or with **europrofile** cylinder hole (yale)

VERSIONI / VERSIONS



		LV BG	OC OSC	
128 MP 049	maniglia art. 128 con placca 049 yale con molla e grano lever handle art. 128 on yale plate 049 with spring and grub screw	•	•	1
128 MP 049	maniglia art. 128 con placca 049 cieca con molla e grano lever handle art. 128 on blind plate 049 with spring and grub screw	•	•	1
128 MP 188	maniglia art. 128 con placca 188 yale con molla e grano lever handle art. 128 on yale plate 188 with spring and grub screw	•	•	1
128 MP 188	maniglia art. 128 con placca 188 cieca con molla e grano lever handle art. 128 on blind plate 188 with spring and grub screw	•	•	1
128 MR 008	maniglia art. 128 con rosetta 008 con bocchetta yale, molla e grano lever handle art. 128 on plate 008 with yale key hole, spring and grub screw	•	•	1
128 MR 008	maniglia art. 128 con rosetta 008 senza bocchetta con molla e grano lever handle art. 128 on plate 008 without rose for key with spring and grub screw	•	•	1

SICUREZZA e PORTE BLINDATE SAFETY AND ARMOURED DOORS



art. CD 002

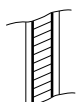

Spessore porta / Door thickness
da mm 64 (50*) a mm 90

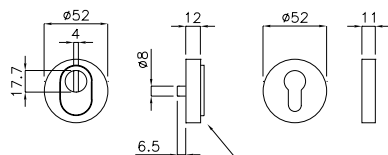

Regolabile per sporgenza cilindro da 8 a 15 mm
Adjustable for cylinder projection 8-15 mm



LV

Ø52



ART.	LV	BG	OSC OC	AN	PVD	
CD 002 Set bocchette di sicurezza Ø52 con protezione cilindro regolabile e 2 viti passanti M5 interasse mm 38 completo di sottobocchetta in acciaio speciale temprato antitrapano Safety escutcheon Ø52 with euro cylinder protection adjustable and 2 screws door through M5 center to center mm 38 - internal steel hardened protection rose	•	•	•	•	•	1

art. CD Q02

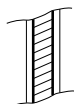

Spessore porta / Door thickness
da mm 64 (50*) a mm 90

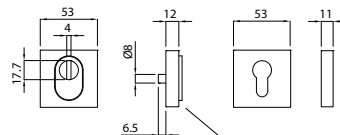

Regolabile per sporgenza cilindro da 8 a 15 mm
Adjustable for cylinder projection 8-15 mm



OSC



ART.	LV	OSC OC	
CD Q02 Set bocchette quadrate di sicurezza con protezione cilindro regolabile e 2 viti passanti M5 interasse mm 38-completo di sottobocchetta in acciaio speciale temprato antitrapano Safety escutcheon with euro cylinder protection adjustable and 2 screws door through M5 center to center mm 38-internal steel hardened protection rose	•	•	1

art. CD 006

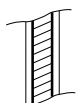

Spessore porta / Door thickness
da mm 74 (60*) a mm 80

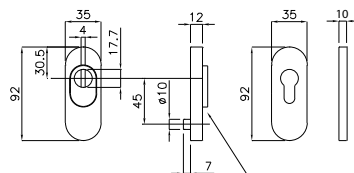

Regolabile per sporgenza cilindro da 8 a 15 mm
Adjustable for cylinder projection 8-15 mm



LV



PVD INOX



ART.	LV BG	OSC OC	AN	AGV	PVD PVD INOX	
CD 006 Set bocchette di sicurezza ovali mm 92x35 con protezione cilindro regolabile e 2 viti passanti M6 completo di sottobocchetta in acciaio speciale temprato antitrapano Oval safety escutcheon mm 92x35 with euro cylinder protection adjustable and 2 screws door through M6 - internal steel hardened protection rose	•	•	•	•	•	1

art. CD Q06

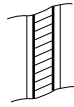

Spessore porta / Door thickness
da mm 74 (60*) a mm 80



OSC

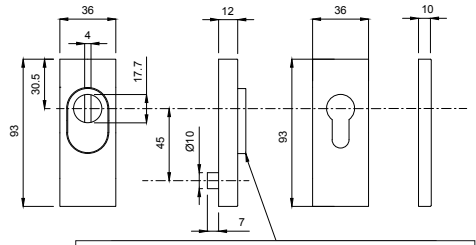

Regolabile per sporgenza cilindro da 8 a 15 mm
Adjustable for cylinder projection 8-15 mm



ART.

CD Q06

Set bocchette di sicurezza rettangolari mm 92x35 con protezione cilindro regolabile e 2 viti passanti M6 completo di sottobocchetta in acciaio speciale temprato antitrapano
Rectangular safety escutcheon mm 92x35 with euro cylinder protection adjustable and 2 screws door through M6 - internal steel hardened protection rose

LV	OSC OC	PVD PVD INOX	
•	•	•	1

art. CD 008

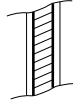

Spessore porta / Door thickness
da mm 64 (50*) a mm 90



LV

Ø53

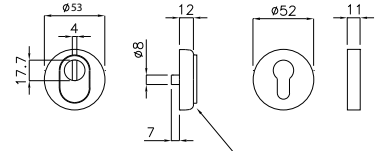

Regolabile per sporgenza cilindro da 8 a 11 mm
Adjustable for cylinder projection 8-11 mm



ART.

CD 008

Set bocchette di sicurezza Ø53 con protezione cilindro **regolabile** e 2 viti passanti M5 interasse mm 38
Safety escutcheon Ø53 with euro cylinder protection **adjustable** and 2 screws door through M5 center to center mm 38

LV	BG	OSC OC	PVD	
•	•	•	•	1

art. CD 004

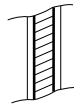

Spessore porta / Door thickness
da mm 64 (50*) a mm 90



INOX SAT.

Ø55

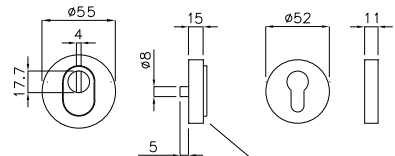

Regolabile per sporgenza cilindro da 11 a 15 mm
Adjustable for cylinder projection 11-15 mm



CD 004

Set bocchette di sicurezza Ø55 con protezione cilindro **regolabile** e 2 viti passanti M5 interasse mm 38 completo di sottobocchetta in acciaio speciale temprato **antitrapano**
Safety escutcheon Ø55 with euro cylinder protection **adjustable** and 2 screws door through M5 center to center mm 38 internal steel hardened **protection rose**

INOX SAT.

INOX SAT.	
•	1

art. C06RO - CQ6RO



C06 RO LV



C06 RO OSC

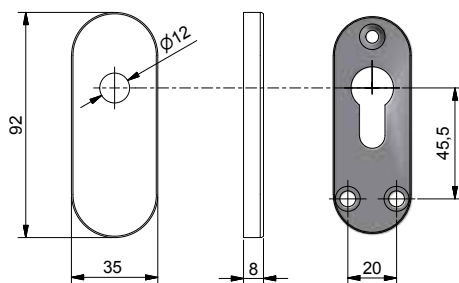

ESEMPIO DI APPLICAZIONE

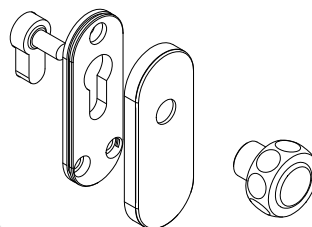

ART.		LV BG	OSC OC	AN	AGV	PVD PVD INOX	
C06 RO	Bocchetta ovale coprivite con foro asse per cilindretti con codolo Oval cover screw rose for cylinders with tang	•	•	•	•	•	12
CQ6 RO	Bocchetta rettangolare coprivite con foro asse per cilindretti con codolo Rectangular cover screw rose for cylinders with tang	• LV	•	-	-	•	12

INFO TECNICA - ACCESSORI PER CD SICUREZZA TECHNICAL INFO - ACCESSOIRES FOR SAFETY CD



VITE CAVA ESAGONALE TCE ACCIAIO M5 O M6



CD Q02



CD 004



CD 002



CD 008



CD 006



CD Q06



		Viti adatte per spessore porta Door Thickness mm	Viti adatte per spessore porta Door Thickness mm	€
	B050V7070TC	M5 X 70	da 64 (50*) a 70	•
	B050V7090TC	M5 X 90	da 84 (70*) a 90	•
	B050V7110TC	M5 X 110	da 104 (90*) a 110	•
	B050V7120TC	M5 X 120	da 114 (100*) a 120	•
	B060V7070TC	M6 X 70	da 64 (50*) a 70	•
	B060V7080TC	M6 X 80	da 74 (60*) a 80	•
	B060V7100TC	M6 X 100	da 94 (80*) a 100	•
	B060V7110TC	M6 X 110	da 104 (90*) a 110	•

* MISURA POSSIBILE TAGLIANDO LA VITE / POSSIBLE SIZE CUTTING SCREW

art. CD 005



LV

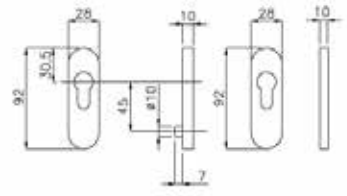

LV BG	OC OSC	PVD PVD INOX	
•	•	•	1

CD 005

Set bocchette di sicurezza ovali mm 92x28 con foro yale e 1 vite passante M8 - completo di sottobocchetta in acciaio speciale temprato **antitrapano**
Oval safety escutcheon mm 92x28 with euro profile cylinder hole (yale) and 1 screw door through M8 - internal **steel hardened** protection rose

art. CD7BY001

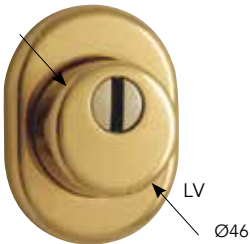

LV

Ø46



OSC



LV	BG	OSC OC	AN	AGV	VBN	PVD	
•	•	•	•	•	•	•	1

BOCCHETTA DI SICUREZZA / SAFETY ESCUTCHEON

CD7 BY 001

Bocchetta di sicurezza esterna mm 82x62 con blocco DEFENDER ANTITRAPANO Ø46 in acciaio CARBONITURATO - DUREZZA 60 ROCKWELL

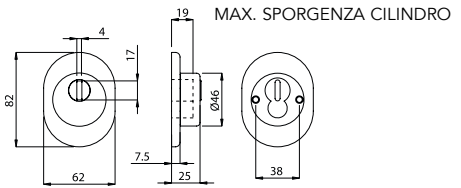

art. 706 BY



706 BY - LV

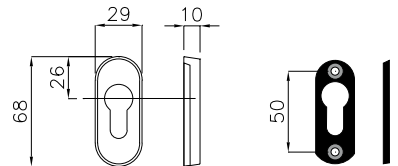

LV BG	OC OSC	PVD
•	•	•



SISTEMA DI MONTAGGIO STANDARD
STANDARD MOUNTING SYSTEM



706 BY

Bocchetta di sicurezza (a baionetta) ovale
Oval safety escutcheon (sliding fitting) with euro profile cylinder hole (yale)

art. 709 BY



709 BY - LV

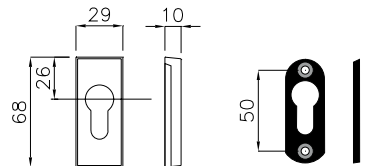

LV BG	OC OSC	PVD
•	•	•



SISTEMA DI MONTAGGIO STANDARD
STANDARD MOUNTING SYSTEM



706 BY

Bocchetta di sicurezza (a baionetta) ovale
Oval safety escutcheon (sliding fitting) with euro profile cylinder hole (yale)

art. 52



B52 HR 008-LV

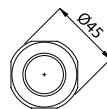
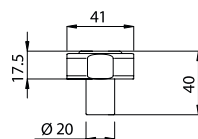

POMOLO PER AZIONAMENTO DISPOSITIVO DI SICUREZZA / KNOB FOR OPENING LIMITING DEVICE

		LV BG	OC OSC	
B52 HR 003	Mezza coppia pomolo Ø45 con ros.003 coprivite Ø45 senza bocchette, con q.8x65 ad espansione e con grano Half pair knob on cover screw rose 003 Ø45 without key rose, with expansion square spindle 8x65	•	•	4
B52 HR 008	Mezza coppia pomolo Ø45 con ros.008 coprivite Ø50 senza bocchette, con q.8x65 ad espansione e con grano Half pair knob on cover screw rose 008 Ø50 without key rose, with expansion square spindle 8x65	•	•	4

art. 54



A54 HR 008-LV

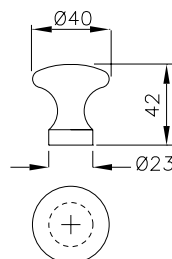

POMOLO PER AZIONAMENTO DISPOSITIVO DI SICUREZZA / KNOB FOR OPENING LIMITING DEVICE

		LV BG	OC OSC	
A54 HR 003	Mezza coppia pomolo Ø40 con ros.003 coprivite Ø45 senza bocchette, con q.8x65 ad espansione e con grano Half pair knob on cover screw rose 003 Ø45 without key rose, with expansion square spindle 8x65	•	•	4
A54 HR 008	Mezza coppia pomolo Ø40 con ros.008 coprivite Ø50 senza bocchette, con q.8x65 ad espansione e con grano Half pair knob on cover screw rose 008 Ø50 without key rose, with expansion square spindle 8x65	•	•	4

art. 54

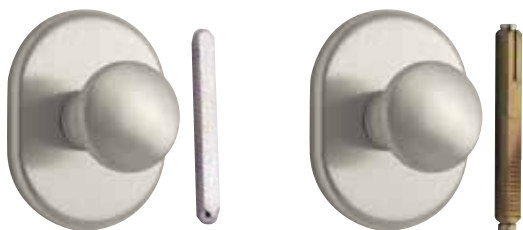

A54 HR 062-OSC

A54 HR 062/F1-OSC

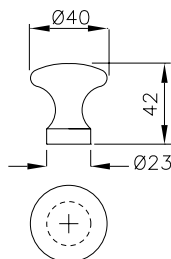

POMOLO PER AZIONAMENTO DISPOSITIVO DI SICUREZZA / KNOB FOR OPENING LIMITING DEVICE

		LV	BG	OSC OC	AN	AGV	VBN	PVD	
A54 HR 062	Mezza coppia pomolo ø40 con rosetta COPRIVITE 062 mm 82 x 62 - senza bocchetta con ferro q.8 normale	•	•	•	•	•	•	•	4
A54HR062/F1	Mezza coppia pomolo ø40 con rosetta COPRIVITE 062 mm 82 x 62 - senza bocchetta con ferro q.8 x65 espansione	•	•	•	•	•	•	•	4

art. 512 SP

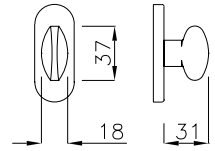

SEGRETINO PICCOLO PER LIMITATORE DI APERTURA / SMALL HANDLE FOR OPENING LIMITING DEVICE

512 SP 062 Segretino piccolo per LIMITATORE DI APERTURA con rosetta COPRITTE 062 mm 82 x 62 con ferro q. 8 normale

	LV	BG	OSC OC	AN	AGV	VBN	PVD	
	•	•	•	•	•	•	•	4

art. 63 SP

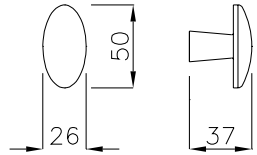

SEGRETINO PICCOLO PER LIMITATORE DI APERTURA / SMALL HANDLE FOR OPENING LIMITING DEVICE

63 SP 003 Segretino piccolo con rosetta Small handle on rose 003 Ø45x7 q.8 Ø45x7 square spindle mm 8

63 SP 007 Segretino piccolo con rosetta Small handle on rose 007 mm 67x27 q.8 mm 67x27 square spindle mm 8

	LV	BG	OSC	OC	
	•			•	12
	•			•	12

art. 512 SP

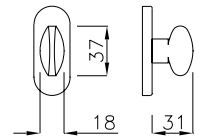
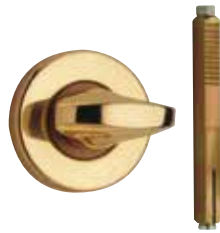

SEGRETINO PICCOLO PER LIMITATORE DI APERTURA / SMALL HANDLE FOR OPENING LIMITING DEVICE

512 SP 003 Segretino piccolo con rosetta Small handle on rose 003 mm 45x7 con q.8x65 ad espansione e con grano mm 45x7 with expansion square spindle 8x65 and grub screw

512 SP 007 Segretino piccolo con rosetta Small handle on rose 007 mm 67x27 q.8 mm 67x27 square spindle mm 8

512 SP 008 Segretino piccolo con rosetta Small handle on rose 008 Ø50x7 con q.8x65 ad espansione e con grano Ø50x7 with expansion square spindle 8x65 and grub screw

	LV BG	OC OSC	
	•	•	12
	•	•	12
	•	•	12



art. 119 PN



119 PN-LV

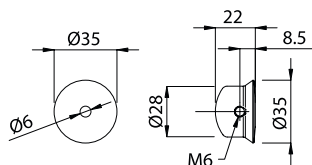

Esempio di applicazione pomolino per limitatore di apertura su porte blindate
Mounting example for opening limiting device knob for armour plated front doors

FUNZIONAMENTO A TRASLAZIONE



119+3BN

POMOLINO STUM PER LIMITATORE DI APERTURA / STUM KNOB FOR OPENING LIMITING DEVICE

119 PN

Pomolo a campana per limitatore di apertura
Knob for opening limiting device



LV	OC OSC	
•	•	30



CD 119

SET ACCESSORI PER MONTAGGIO POMOLINO LIMITATORE DI APERTURA

CD 119

Set c/3 bussole diam.10x19 e 1 troncone M6X90

€ •

art. 52 NN

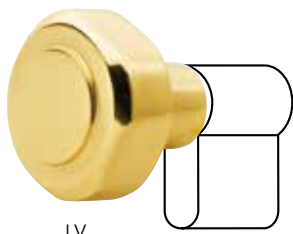

LV

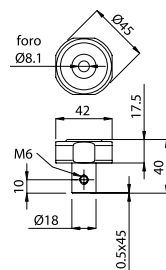

POMOLO PER CILINDRI CON CODOLO / KNOB FOR CYLINDER WITH TANG

52 NN

Pomolo per cilindro Ø45 mm con foro Ø8 mm
Knob for cylinder Ø45 mm with hole Ø8 mm



LV BG	OC OSC	
•	•	6

art. 502 NN

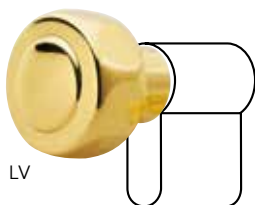

LV

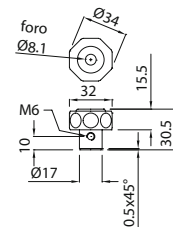

POMOLO PER CILINDRI CON CODOLO / KNOB FOR CYLINDER WITH TANG

502 NN

Pomolo per cilindro Ø34 mm con foro Ø8 mm
Knob for cylinder Ø34 mm with hole Ø8 mm



LV BG OS	OC OSC	AN	
•	•	•	12

art. 503 NN

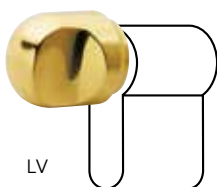

LV

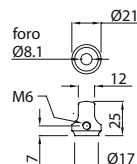

POMOLO PER CILINDRI CON CODOLO / KNOB FOR CYLINDER WITH TANG

503 NN

Pomolo per cilindro Ø21 mm con foro Ø8 mm
Knob for cylinder Ø21 mm with hole Ø8 mm



LV BG	OC OSC	
•	•	24

art. 512 NN

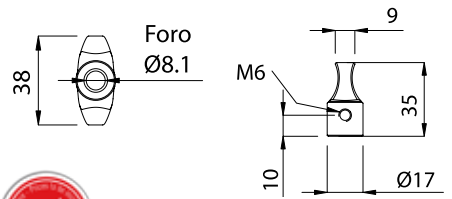
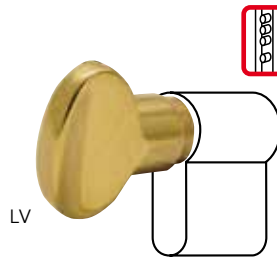

LV BG	OC OSC	AN	AGV	
•	•	•	•	12

POMOLO PER CILINDRI CON CODOLO / KNOB FOR CYLINDER WITH TANG

512 NN

Pomolo Farfalla per cilindro con foro Ø8 mm

art. 124 NN

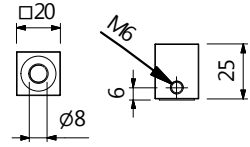
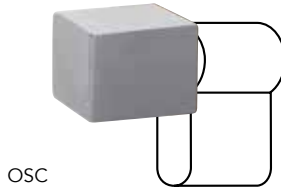

OSC	
•	12

POMOLO QUADRO PER CILINDRI / KNOB FOR CYLINDER WITH TANG

124 NN

Pomolo quadro per cilindro con foro Ø8 mm

art. C03 RO C08 RO - C55 RO

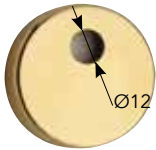

C03 RO-LV

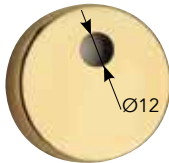

C08 RO-LV



C55 RO-LV

Esempio di applicazione pomolo per cilindro
Mounting example knob for cylinder

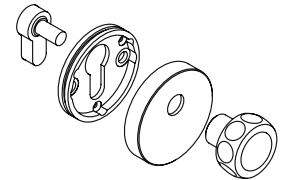

LV BG	OC OSC	
•	•	24
•	•	24
•	•	12

BOCCHETTA CON FORO ASSE

- C03 RO** Bocchetta coprivite Ø45 con foro asse per cilindretti con codolo
Cover screw rose Ø45 for cylinders with tang
- C08 RO** Bocchetta coprivite Ø50 con foro asse per cilindretti con codolo
Cover screw rose Ø50 for cylinders with tang
- C55 RO** Bocchetta coprivite Ø55 con foro asse per cilindretti con codolo
Cover screw rose Ø55 for cylinders with tang

art. CQ8 RO



CQ8 RO-OSC

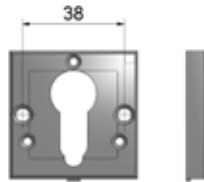
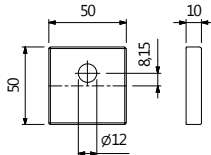

Nylon

Esempio di applicazione
Mounting example

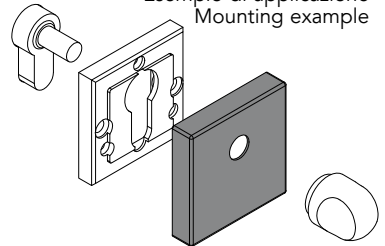

SISTEMA DI MONTAGGIO STANDARD
STANDARD MOUNTING SYSTEM



BOCCHETTA CON FORO ASSE PER CILINDRO

- CQ8 RO** Bocchetta quadrata con foro asse per cilindretti
Square rose for cylinders with tag



Finiture Finishes	LV	OC	OSC	SNV
	€	€	€	€
	•	•	•	•

art. C62 RO



OSC

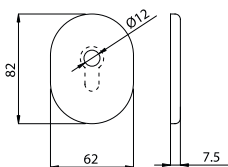

Esempio di applicazione pomolo per cilindro su C62 RO
Mounting example knob for cylinder on rose C62



BOCCHETTA CON FORO ASSE

C62 RO Bocchetta COPRIVITE mm 82 x 62 con foro asse per cilindretti con codolo POMOLO ESCLUSO

	LV	BG	OSC OC	AN	AGV	VBN	PVD	
	•	•	•	•	•	•	•	12

art. 171 KP

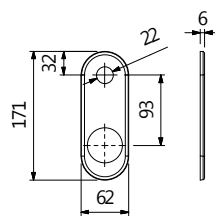
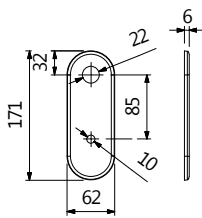
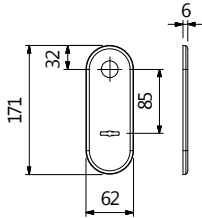
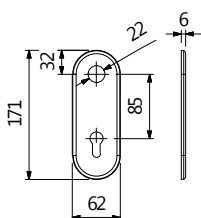

171KP - 11 - ALL. SAT.



171KP - D1 - ALL. SAT.



171KP - C8 - ALL. SAT.



171KP - D6 - ALL. SAT.



PLACCA PER PORTE BLINDATE

		LV BG	OC	AN	AGV	ALL. SAT.	
171KP***11	Placca per porte blindate yale distanza 85	•	•	•	•	•	12
171KP***D1	Placca per porte blindate doppia mappa distanza 85	•	•	•	•	•	12
171KP***C8	Placca per porte blindate con foro codolo cilindro distanza 85	•	•	•	•	•	12
171KP***D6	Placca per porte blindate con foro tondo per defender ø 46	•	•	•	•	•	12



art. 003 DM - 008 DM - 055 DM

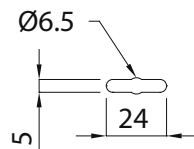
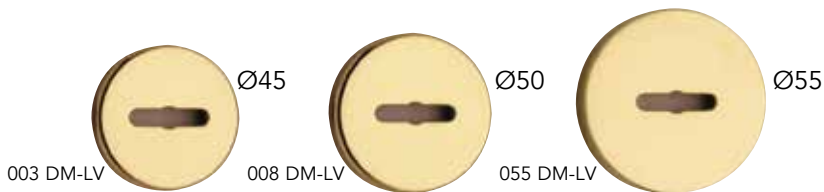

		+6%		LV BG	OC OSC	
BOCCHETTA CON FORO DOPPIA MAPPA						
003 DM	Bocchetta coprivite Ø45 con foro doppia mappa Cover screw rose Ø45 with key hole for safety	•	•	•	•	24
008 DM	Bocchetta coprivite Ø50 con foro doppia mappa Cover screw rose Ø50 with key hole for safety	•	•	•	•	24
055 DM	Bocchetta coprivite Ø55 con foro doppia mappa Cover screw rose Ø55 with key hole for safety	•	•	•	•	12

art. 062 DM

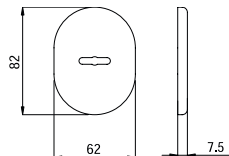
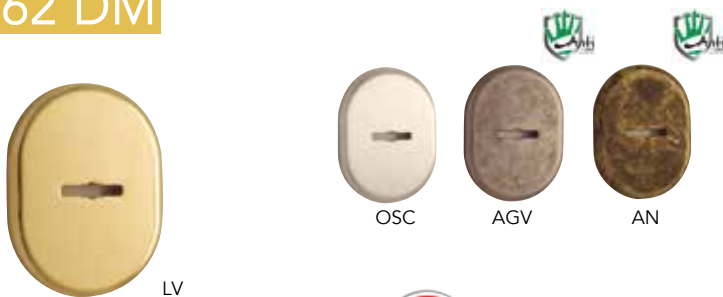

		+6%		LV	BG	OSC OC	AN	AGV	VBN	PVD	
BOCCHETTA CON FORO DOPPIA MAPPA											
062 DM	Bocchetta COPRIVITE mm 82 x 62 con doppia mappa Cover screw rose mm 82x62 with key hole for safety	•	•	•	•	•	•	•	•	•	12

art. 003 BY - 008 BY - 055 BY



		+6%		LV BG	OC OSC	
BOCCHETTA CON FORO YALE						
003 BY	Bocchetta coprivite Ø45 con foro yale Cover screw rose Ø45 for euro profile cylinder hole (yale)	•	•	•	•	24
008 BY	Bocchetta coprivite Ø50 con foro yale Cover screw rose Ø50 for euro profile cylinder hole (yale)	•	•	•	•	24
055 BY	Bocchetta coprivite Ø55 con foro yale Cover screw rose Ø55 for euro profile cylinder hole (yale)	•	•	•	•	12



art. 062 BY



LV



OSC



AGV



AN



RX

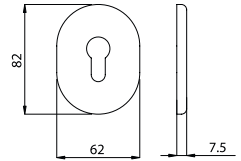

LV	BG	OSC OC	AN	AGV	RX	VBN	PVD	
•	•	•	•	•	•	•	•	↔

BOCCHETTA CON FORO YALE

062 BY Bocchetta COPRIMITE mm 82 x 62 con foro yale
Cover screw rose mm 82x62 for euro profile cylinder hole (yale)

art. 062 BN



LV



OSC

Esempio di applicazione pomolino per limitatore di apertura su 062BN
Mounting example small knob for opening limiting device

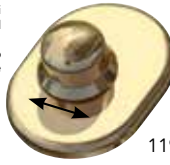

119 PN+062 BN

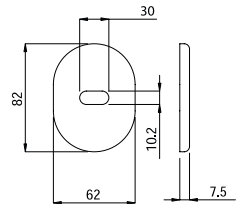

LV	OS BG	OSC OC	AN	AGV	VBN	PVD	
•	•	•	•	•	•	•	📦

BOCCHETTA CON FORO CHIAVE ORIZZONTALE

062 BN Bocchetta COPRIMITE mm 82 x 62 per LIMITATORE DI APERTURA CON FUNZIONAMENTO A TRASLAZIONE POMOLINO ESCLUSO

art. CD7 RO

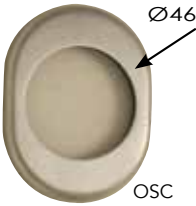

OSC



LV

Ø46

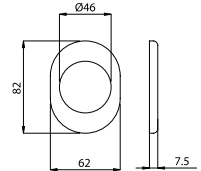

LV	BG	OSC OC	AN	AGV	RX	VBN	PVD	
•	•	•	•	•	•	•	•	📦

ROSETTA PER DEFENDER

CD7RO Rosetta coprivite mm 82x62 con foro ø46

art. COPBY CD7



LV



OSC

Ø46

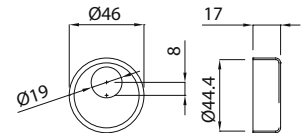

LV	BG	OSC OC	AN	AGV	RX	VBN	PVD	
•	•	•	•	•	•	•	•	📦

BOCCHETTA COPRIDEFENDER

COPBYCD7 COPRIDEFENDER Ø46



art. 062 RO

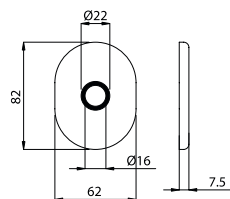

	LV	BG	OSC OC	AN	AGV	RX	VBN	PVD	
ROSETTA 062 RO	•	•	•	•	•	•	•	•	12

art. 637 DD

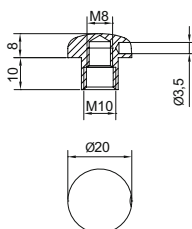
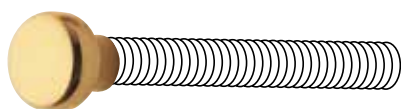

OSC



OC

LV



DADO DOPPIO FILETTO / DOUBLE THREADED NUT

637 DD

Dado doppio filetto Ø20 per troncone M8/M10
Double threaded nut Ø20 for screw M8/M10

	LV OB	OC OSC	PVD	
	•	•	•	24

art. 638 DD



LV



OB



OC

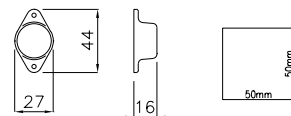

COPRIDADO / COVER-NUT

638 DD

copridado mm 44x27
cover-nut mm 44x27

	LV OB	OC OSC	
	•	•	50

art. F1

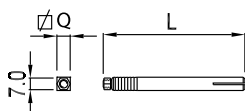

FERRO AD ESPANSIONE CON DADO / EXPANSION SQUARE SPINDLE WITH NUT

	∅	L	€
B007F1065**3E FERRO 7X65	7	65	•
B008F1055**3E FERRO 8X55	8	55	•
B008F1065**3E FERRO 8X65	8	65	•
B008F1080**3E FERRO 8X80	8	80	•
B008F1095**3E FERRO 8X95	8	95	•
B008F10105**3E FERRO 8X105	8	105	•
B008F10115**3E FERRO 8X115	8	115	•
B008F10125**3E FERRO 8X125	8	125	*

* Solo a richiesta e per quantità da definire



art.

F5

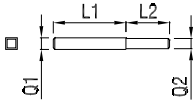

FERRO DOPPIO QUADRO / DOUBLE SQUARE SPINDLE

		Q1	L1	Q2	L2	€
B630F5750**3D	FERRO Ø 6X30/7X50	7	50	6	30	•
B630F5850**3D	FERRO Ø 6X30/8X50	8	50	6	30	•
B730F5840**3D	FERRO Ø 7X30/8X40	8	40	7	30	•
B730F5845**3D	FERRO Ø 7X30/8X45	8	45	7	30	•
B730F5890**3D	FERRO Ø 7X30/8X90	8	90	7	30	•
B740F5845**3D	FERRO Ø 7X40/8X45	8	45	7	40	•
B745F5845**3D	FERRO Ø 7X45/8X45	8	45	7	45	•
B790F5845**3D	FERRO Ø 7X90/8X45	8	45	7	90	•

art.

F8

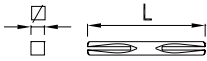

FERRO CON 2 FRESATURE E 2 TAGLI / SQUARE SPINDLE WITH 2 MILLED SLOTS

		Ø	L	€
B007F8105**3D	FERRO Ø 7X105	7	105	•
B007F8120**3D	FERRO Ø 7X120	7	120	•
B008F8095**3D	FERRO Ø 8X95	8	95	•
B008F8100**3D	FERRO Ø 8X100	8	100	•
B008F8105**3D	FERRO Ø 8X105	8	105	•
B008F8110**3D	FERRO Ø 8X110	8	110	•
B008F8115**3D	FERRO Ø 8X115	8	115	•
B008F8120**3D	FERRO Ø 8X120	8	120	•
B008F8130**3D	FERRO Ø 8X130	8	130	•
B008F8140**3D	FERRO Ø 8X140	8	140	•
B008F8150**3D	FERRO Ø 8X150	8	150	•
B008F8170**3D	FERRO Ø 8X170	8	170	•

art.

F9



FERRO CON PIASTRINA Ø18 FRESATO E TAGLIATO / SQUARE SPINDLE WITH FIXED WASHER AND MILLED SLOT

		€
B008F9070**3D	FERRO □ 8X70	•
B008F9090**3D	FERRO □ 8X90	•



art. F02 FB

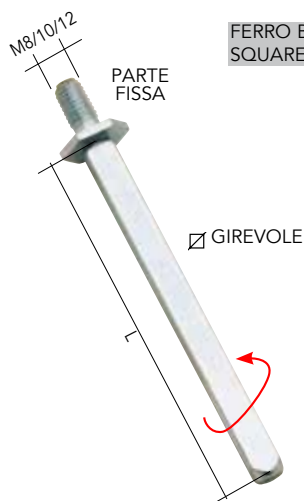

FERRO BLOCCA POMOLO CON ESAGONO CON FILETTO M8, M10, M12 SQUARE SPINDLE WITH THREADED ROLLER M8, M10, M12

			M	L	€
BF02FB070083D	FERRO	Ø 8X70 -FILETTO M8	8	70	•
BF02FB080083D	FERRO	Ø 8X80 -FILETTO M8	8	80	•
BF02FB090083D	FERRO	Ø 8X90 -FILETTO M8	8	90	•
BF02FB100083D	FERRO	Ø 8X100 -FILETTO M8	8	100	•
BF02FB110083D	FERRO	Ø 8X110 -FILETTO M8	8	110	•
BF02FB130083D	FERRO	Ø 8X130 -FILETTO M8	8	130	•
BF02FB070103D	FERRO	Ø 8X70 -FILETTO M10	10	70	•
BF02FB080103D	FERRO	Ø 8X80 -FILETTO M10	10	80	•
BF02FB090103D	FERRO	Ø 8X90 -FILETTO M10	10	90	•
BF02FB100103D	FERRO	Ø 8X100 -FILETTO M10	10	100	•
BF02FB110103D	FERRO	Ø 8X110 -FILETTO M10	10	110	•
BF02FB130103D	FERRO	Ø 8X130 -FILETTO M10	10	130	•
BF02FB070123D	FERRO	Ø 8X70 -FILETTO M12	12	70	•

art. F03 FB

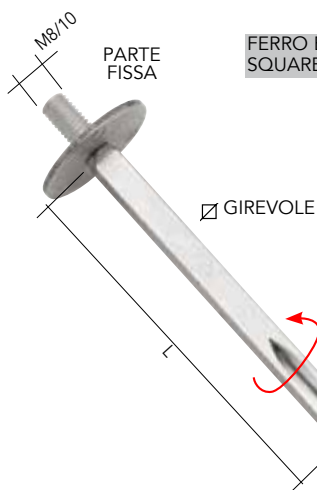

FERRO BLOCCA POMOLO CON PIASTRINA P3 Ø35 FILETTATA M8, M10 SQUARE SPINDLE WITH Ø35 P3 FIXING BASE M8, M10

			M	L	€
BF03FB070083D	FERRO	Ø 8X70 -FILETTO M8	8	70	•
BF03FB080083D	FERRO	Ø 8X80 -FILETTO M8	8	80	•
BF03FB090083D	FERRO	Ø 8X90 -FILETTO M8	8	90	•
BF03FB100083D	FERRO	Ø 8X100 -FILETTO M8	8	100	•
BF03FB110083D	FERRO	Ø 8X110 -FILETTO M8	8	110	•
BF03FB130083D	FERRO	Ø 8X130 -FILETTO M8	8	130	•
BF03FB070103D	FERRO	Ø 8X70 -FILETTO M10	10	70	•
BF03FB080103D	FERRO	Ø 8X80 -FILETTO M10	10	80	•
BF03FB090103D	FERRO	Ø 8X90 -FILETTO M10	10	90	•
BF03FB100103D	FERRO	Ø 8X100 -FILETTO M10	10	100	•
BF03FB110103D	FERRO	Ø 8X110 -FILETTO M10	10	110	•
BF03FB130103D	FERRO	Ø 8X130 -FILETTO M10	10	130	•

art. F04 QB



FERRO BLOCCA POMOLO CON PIASTRINA P2 Ø35 CON QUADRO 8 SQUARE SPINDLE WITH Ø35 P2 FIXING BASE WITH MM 8 SQUARE SPINDLE

				€
BF04QB070083D	FERRO	Ø 8X70		•
BF04QB080083D	FERRO	Ø 8X80		•
BF04QB090083D	FERRO	Ø 8X90		•
BF04QB100083D	FERRO	Ø 8X100		•
BF04QB110083D	FERRO	Ø 8X110		•
BF04QB130083D	FERRO	Ø 8X130		•



art. F10 FB

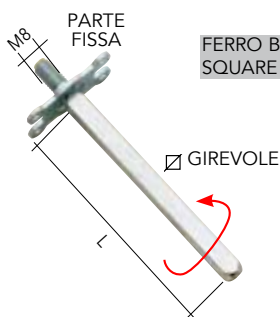

FERRO BLOCCA POMOLO CON PIASTRINA P4 FILETTATA M8
SQUARE SPINDLE WITH M8 THREADED PLATE P4

BF10FB070083D	FERRO	∇	8X70-FILETTO	M8	•
BF10FB080083D	FERRO	∇	8X80-FILETTO	M8	•
BF10FB090083D	FERRO	∇	8X90-FILETTO	M8	•
BF10FB100083D	FERRO	∇	8X100-FILETTO	M8	•
BF10FB110083D	FERRO	∇	8X110-FILETTO	M8	•
BF10FB130083D	FERRO	∇	8X130-FILETTO	M8	•

art. F11 QB

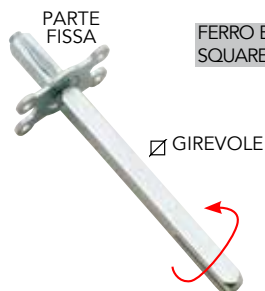

FERRO BLOCCA POMOLO CON PIASTRINA P5 CON QUADRO 8
SQUARE SPINDLE WITH PLATE P5 WITH MM 8 SQUARE SPINDLE

BF11QB070083D	FERRO	∇	8X70	•
BF11QB080083D	FERRO	∇	8X80	•
BF11QB090083D	FERRO	∇	8X90	•
BF11QB100083D	FERRO	∇	8X100	•
BF11QB110083D	FERRO	∇	8X110	•
BF11QB130083D	FERRO	∇	8X130	•

art. P1

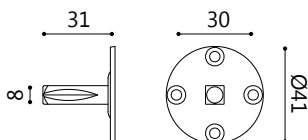

PIASTRINA TONDA Ø41 CON QUADRO 8 / Ø41 FIXING BASE WITH MM 8 SQUARE SPINDLE
B000P1000003D

art. P2

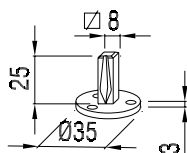

PIASTRINA TONDA Ø35 CON QUADRO 8 / Ø35 FIXING BASE WITH MM 8 SQUARE SPINDLE
B000P2000003D

art.

P3

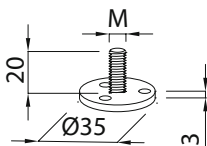

PIASTRINA TONDA Ø35 CON FILETTO M8 O M10 / PLATE Ø35 WITH M8 OR M10 THREADED PIN

B000P3080003D

M

€

M8

•

B000P3100003D

M10

•

art.

P4

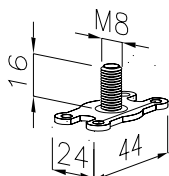

PIASTRINA CON FILETTO M8 / FIXING BASE WITH M8 THREADED PIN

B000P4080003D

€

•

La dimensione e la forma particolare dell'art. P4 è stata studiata appositamente per consentire l'abbinamento alle rosette ovali tipo 007, C07, 009 e R37 e alle placche per maniglie.
Dimension and shape of art. P4 has been studied to fit with oval roses 007, C07, 009, R37 and with plates for lever.

art.

P5

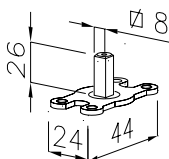

PIASTRINA CON QUADRO 8 / FIXING BASE WITH MM8 SQUARE SPINDLE

B000P5000003D

€

•

La dimensione e la forma particolare dell'art. P5 è stata studiata appositamente per consentire l'abbinamento alle rosette ovali tipo 007, C07, 009 e R37 e alle placche per maniglie.
Dimension and shape of art. P5 has been studied to fit with oval roses 007, C07, 009, R37 and with plates for lever.

art. E56 PF



E56 PF F71/F2-OSC

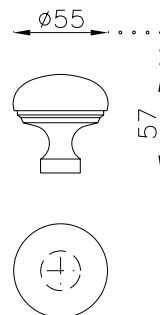

POMOLO 56 Ø 60 FISSO SU PLACCA F71 CON F02 - FERRO CON FOLLE

E56PFF71/F2

Pomolo fisso art.56 ø 60 con placca F71 con ferro F2 con \square 8 lungo 70-80-90-100-110*LV
BGOC
OSC

AN

AGV



•

•

•

•

2

* Lunghezza ferro da specificare in base allo spessore porta

art. **56 PF**

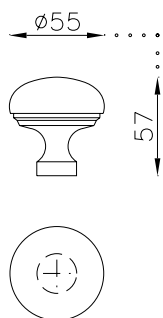

E56 PF 037/F2-LV



E56 PF P08/F2-LV



POMOLO FISSO CON FERRO CON FOLLE / FIXED KNOB WITH SPINDLE WITH IDLE

		LV BG	OC OSC	
E56 PF 037/F2	Pomolo Fisso art.56 Ø 60 con placca 037 yale con ferro F2 con q.8 lungo 90-100-110* Fixed Knob art.56 Ø 60 on plate yale with F2 spindle-length 90-100-110*	•	•	2
E56 PF P08/F2	Pomolo Fisso art.56 Ø60 con rosetta P08 Ø 50 con ferro F2 con q.8 lungo 90-100-110* Fixed Knob art.56 Ø60 on rose Ø 50 with F2 spindle - length 90-100-110*	•	•	4

* Lunghezza ferro da specificare in base allo spessore porta / Length spindle to specify according door thickness

art. **345 PF**



sinistro e fisso
left and fix

345 PF 037/F2-LV

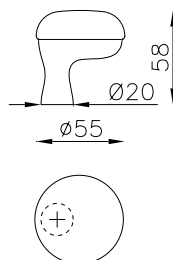

Specificare se destro o sinistro
Please specify if right or left



POMOLO FISSO CON FERRO CON FOLLE / FIXED KNOB WITH SPINDLE WITH IDLE

		LV BG	OC OSC	
345 PF 037/F2	Pomolo Fisso art.345 con placca 037 yale con ferro F2 con q.8 lungo 90-100-110* Fixed Knob art.345 on plate yale with F2 spindle-length 90-100-110*	•	•	2

* Lunghezza ferro da specificare in base allo spessore porta / Length spindle to specify according door thickness

art. E56 PF



E56PF62-LV



E56PF62/F2-OSC

POMOLO FISSO / FIXED KNOB

		LV	OS BG	OSC OC	AN	AGV	VBN	PVD	PVD INOX	
E56PF62	Pomolo fisso art.56 ø60 con rosetta COPRIVITE F62 mm 82 x 62	•	•	•	•	•	•	•	•	4
E56PF62/F2	Pomolo fisso art.56 ø60 con rosetta COPRIVITE F62 mm 82 x 62 con ferro F02 con q.8 lungo 90-100-110*	•	•	•	•	•	•	•	•	4

* Lunghezza ferro da specificare in base allo spessore porta / Length spindle to specify according door thickness

art. H56 PF



H56PF62-OSC



POMOLO FISSO / FIXED KNOB

		LV	OS BG	OSC OC	AN	AGV	VBN	PVD	PVD INOX	
H56PF62	Pomolo fisso art.56 ø75 con rosetta COPRIVITE F62 mm 82 x 62	•	•	•	•	•	•	•	•	2
H56PF62/F2	Pomolo fisso art.56 ø75 con rosetta COPRIVITE F62 mm 82 x 62 con ferro F02	•	•	•	•	•	•	•	•	2

* Lunghezza ferro da specificare in base allo spessore porta / Length spindle to specify according door thickness

art. 16 PM

ESEMPIO DI GUARNITURA CON MANIGLIA GIREVOLE SU LATO PORTA INTERNO E POMOLO FISSO SU LATO PORTA ESTERNO, COLLEGATI DA FERRO F2 CON FOLLE, LUNGHEZZA MM 90 - 100 - 110. TUTTE LE NOSTRE MANIGLIE E POMOLI POSSONO ESSERE ABBINATI TRA LORO.
 EXAMPLE OF TURNABLE INSIDE LEVER AND FIXED OUTSIDE KNOB WITH SPECIAL SPINDLE F2 WITH IDLE, LENGTH SPINDLE MM 90 - 100 - 110. EVERY OUR LEVER AND KNOB CAN BE CONNECTED.



LUNGHEZZA FERRO DA SPECIFICARE IN BASE ALLO SPESSORE PORTA.
 SPINDLE LENGTH TO BE SPECIFY ACCORDING TO DOOR THICKNESS.

POSSIBILE METTERE LE VITI DI CONNESSIONE INTERASSE MM 38
 CON UN EXTRA DI € 0,34



		LV BG	OC OSC	
16 PM 091	Maniglia art.16 con rosetta 008 senza molla, con grano, pomolo art.56 Ø60 con rosetta P08, senza bocchette Lever handle art.16 on rose 008 without spring with grub screw, fixed knob art.56 Ø60 on rose P08, without key rose	•	•	1
16 PM 092	Maniglia art.16 con rosetta 008 senza molla, con grano, pomolo art.56 Ø75 con rosetta P08, senza bocchette Lever handle art.16 on rose 008 without spring with grub screw, fixed knob art.56 Ø75 on rose P08, without key rose	•	•	1

art. **31 PM**

ESEMPIO DI GUARNITURA CON MANIGLIA GIREVOLE SU LATO PORTA INTERNO E POMOLO FISSO SU LATO PORTA ESTERNO, COLLEGATI DA FERRO F2 CON FOLLE, LUNGHEZZA MM 90 - 100 - 110. TUTTE LE NOSTRE MANIGLIE E POMOLI POSSONO ESSERE ABBINATI TRA LORO.
 EXAMPLE OF TURNABLE INSIDE LEVER AND FIXED OUTSIDE KNOB WITH SPECIAL SPINDLE F2 WITH IDLE, LENGTH SPINDLE MM 90 - 100 - 110. EVERY OUR LEVER AND KNOB CAN BE CONNECTED.



LV

LUNGHEZZA FERRO DA SPECIFICARE IN BASE ALLO SPESSORE PORTA.
 SPINDLE LENGTH TO BE SPECIFY ACCORDING TO DOOR THICKNESS.

POSSIBILE METTERE LE VITI DI CONNESSIONE INTERASSE MM 38
 CON UN EXTRA DI € 0,34



F2



	LV BG	OC OSC	
31 PM 091 Maniglia art.31* con rosetta 008 Ø50, molla e grano, pomolo art.56 Ø60 fisso su rosetta P08 Ø50 con ferro F2, senza bocchette Lever handle art.31* on rose 008 Ø50 with spring and grub screw, fixed knob art.56 Ø60 on rose P08 Ø50, with F2 spindle, without key rose	•	•	1

*da specificare per la maniglia se DX o SX e lunghezza ferro F2 se mm 90-100-110 / to be specified LR or RH hand, and for spindle length 90-100-110 size

art. **31 PM**

ESEMPIO DI GUARNITURA CON MANIGLIA GIREVOLE SU LATO PORTA INTERNO E POMOLO FISSO SU LATO PORTA ESTERNO, COLLEGATI DA FERRO F2 CON FOLLE, LUNGHEZZA MM 90 - 100 - 110. TUTTE LE NOSTRE MANIGLIE E POMOLI POSSONO ESSERE ABBINATI TRA LORO.
 EXAMPLE OF TURNABLE INSIDE LEVER AND FIXED OUTSIDE KNOB WITH SPECIAL SPINDLE F2 WITH IDLE, LENGTH SPINDLE MM 90 - 100 - 110. EVERY OUR LEVER AND KNOB CAN BE CONNECTED.



LV

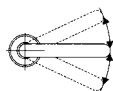

LUNGHEZZA FERRO DA SPECIFICARE IN BASE ALLO SPESSORE PORTA.
 SPINDLE LENGTH TO BE SPECIFY ACCORDING TO DOOR THICKNESS.



F2



	LV BG	OC OSC	
31 PM 121 Maniglia art.31 con rosetta 416 Ø45, molla DX/SX e grano da una parte e pomolo art.56 Ø60 fisso su rosetta P08 Ø50 con ferro F2*, senza bocchette Lever handle art.31 on rose 416 Ø45 with RH/LH spring and grub screw, fixed knob art.56 Ø60 on rose P08 Ø50, with F2* spindle, without key rose	•	•	1

*da specificare lunghezza ferro F2 se mm 90-100-110

art. **31 PM**

ESEMPIO DI GUARNITURA CON MANIGLIA GIREVOLE SU LATO PORTA INTERNO E POMOLO FISSO SU LATO PORTA ESTERNO, COLLEGATI DA FERRO F2 CON FOLLE, LUNGHEZZA MM 90 - 100 - 110. TUTTE LE NOSTRE MANIGLIE E POMOLI POSSONO ESSERE ABBINATI TRA LORO.
 EXAMPLE OF TURNABLE INSIDE LEVER AND FIXED OUTSIDE KNOB WITH SPECIAL SPINDLE F2 WITH IDLE, LENGTH SPINDLE MM 90 - 100 - 110. EVERY OUR LEVER AND KNOB CAN BE CONNECTED.



LV LUNGHEZZA FERRO DA SPECIFICARE IN BASE ALLO SPESSORE PORTA.
 SPINDLE LENGTH TO BE SPECIFY ACCORDING TO DOOR THICKNESS.



	LV BG	OC OSC	
31 PM F62 Maniglia art.31* con rosetta 062 mm 82x62 con molla e grano, pomolo 56 ø60 fisso c/ros. F62 mm 82x62 collegati da F2, senza bocchette Lever handle art.31* on rose 062 mm82x62 with spring and grub screw, fixed knob art.56 Ø60 on rose F62 mm82x62, with F2 spindle, without key rose	•	•	1

*da specificare per la maniglia se DX o SX e lunghezza ferro F2 se mm 90-100-110 / to be specified LR or RH hand, and for spindle length 90-100-110 size

art. **37 PM**

ESEMPIO DI GUARNITURA CON MANIGLIA GIREVOLE SU LATO PORTA INTERNO E POMOLO FISSO SU LATO PORTA ESTERNO, COLLEGATI DA FERRO F2 CON FOLLE, LUNGHEZZA MM 90 - 100 - 110. TUTTE LE NOSTRE MANIGLIE E POMOLI POSSONO ESSERE ABBINATI TRA LORO.
 EXAMPLE OF TURNABLE INSIDE LEVER AND FIXED OUTSIDE KNOB WITH SPECIAL SPINDLE F2 WITH IDLE, LENGTH SPINDLE MM 90 - 100 - 110. EVERY OUR LEVER AND KNOB CAN BE CONNECTED.

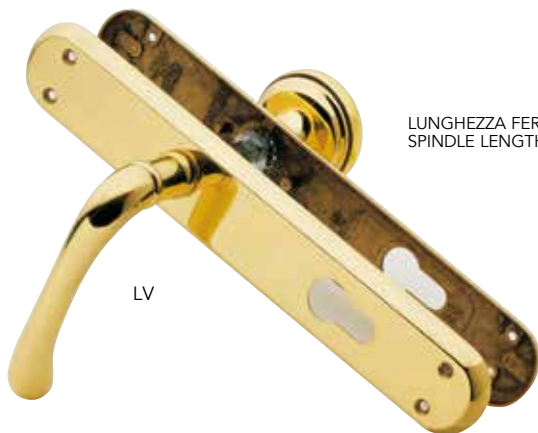

LV LUNGHEZZA FERRO DA SPECIFICARE IN BASE ALLO SPESSORE PORTA.
 SPINDLE LENGTH TO BE SPECIFY ACCORDING TO DOOR THICKNESS.



	LV BG	OC OSC	
37 PM 001	•	•	1

art. 31 RD - 31 RS

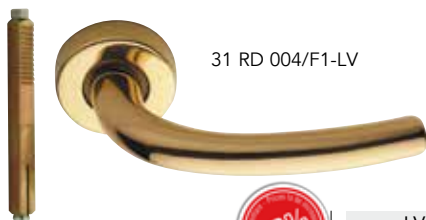

31 RD 004/F1-LV



MEZZA MANIGLIA / HALF LEVER HANDLE

		LV BG	OSC	OSC	
31 RD 004/F1	Mezza maniglia destra con ros.004 Ø45x12 con molla e grano senza bocchetta, con q.8x65 ad espansione Half RH lever on cover screw rose 004 Ø45x12 with spring and grub screw without key rose, with expansion square spindle 8x65	•	•	•	10
31 RD 004	Mezza maniglia destra con ros.004 Ø45x12 con molla e grano senza bocchetta Half RH lever on cover screw rose 004 Ø45x12 with spring and grub screw without key rose	•	•	•	10
31 RS 004/F1	Mezza maniglia sinistra con ros.004 Ø45x12 con molla e grano senza bocchetta, con q.8x65 ad espansione Half LH lever on cover screw rose 004 Ø45x12 with spring and grub screw without key rose, with expansion square spindle 8x65	•	•	•	10
31 RS 004	Mezza maniglia sinistra con ros.004 Ø45x12 con molla e grano senza bocchetta Half LH lever on cover screw rose 004 Ø45x12 with spring and grub screw without key rose	•	•	•	10

art. 31 HM

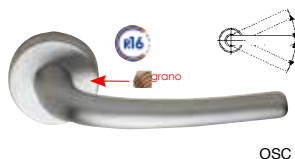

OSC



		LV BG	OSC	ZSC	
31 HM 416	Mezza maniglia art.31 c./ros. 416, con molla DX/SX senza ferro e senza bocchetta	•	•	•	10
31/F HM 416	Mezza maniglia art.31/F TIPO LEGGERO c./ros. 416, con molla DX/SX senza ferro e senza bocchetta	•	•	•	12

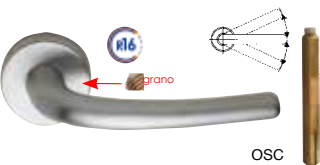

OSC



		LV BG	OSC	ZSC	
31 HM 416/F1	Mezza maniglia art.31 c./ros. 416, con molla DX/SX c/ferro F1 q.8x65 espansione senza bocchetta	•	•	•	10
31/F HM 416/F1	Mezza maniglia art.31/F TIPO LEGGERO c./ros. 416, con molla DX/SX c/ferro F1 q.8x65 espansione senza bocchetta	•	•	•	12

art. 183 HM

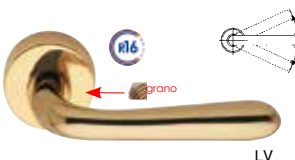

LV

		LV BG	OSC	ZSC	
MEZZA MANIGLIA / HALF LEVER HANDLE					
183 HM 416	Mezza maniglia art.183 c./ros. 416, con molla DX/SX senza ferro e senza bocchetta	•	•	•	10
183/F HM 416	Mezza maniglia art.183/F TIPO LEGGERO c./ros. 416, con molla DX/SX senza ferro e senza bocchetta	•	•	•	12



LV

		LV BG	OSC	ZSC	
MEZZA MANIGLIA / HALF LEVER HANDLE					
183 HM 416/F1	Mezza maniglia art.183 c./ros. 416, con molla DX/SX c/ferro F1 q.8x65 espansione senza bocchetta	•	•	•	10
183/F HM 416/F1	Mezza maniglia art.183/F TIPO LEGGERO c./ros. 416, con molla DX/SX c/ferro F1 q.8x65 espansione senza bocchetta	•	•	•	12

art. 171 HM



ZSC



ZSC

MEZZA MANIGLIA / HALF LEVER HANDLE

171 HM 416 Mezza maniglia art.171 c./ros. 416, con molla DX/SX senza ferro e senza bocchetta



LV BG	OSC	ZSC	
•	•	•	10

MEZZA MANIGLIA / HALF LEVER HANDLE

171 HM 416/F1 Mezza maniglia art.171 c./ros. 416, con molla DX/SX c/ferro F1 q.8x65 espansione senza bocchetta



LV BG	OSC	ZSC	
•	•	•	10

art. 16 HM

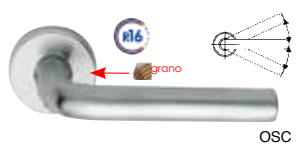

OSC

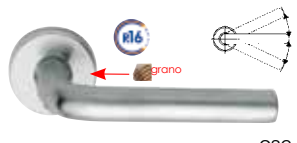

OSC

MEZZA MANIGLIA / HALF LEVER HANDLE

16 HM 416 Mezza maniglia art.16 c./ros. 416, con molla DX/SX senza ferro e senza bocchetta



LV BG	OSC	
•	15,54	10

MEZZA MANIGLIA / HALF LEVER HANDLE

16 HM 416/F1 Mezza maniglia art.16 c./ros. 416, con molla DX/SX c/ferro F1 q.8x65 espansione senza bocchetta



LV BG	OSC	
•	•	10

art. 30 HM



LV

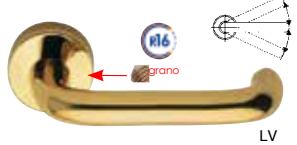

LV

MEZZA MANIGLIA / HALF LEVER HANDLE

30 HM 416 Mezza maniglia art.30 c./ros. 416, con molla DX/SX senza ferro e senza bocchetta



LV BG	OSC	
•	•	10

MEZZA MANIGLIA / HALF LEVER HANDLE

30 HM 416/F1 Mezza maniglia art.30 c./ros. 416, con molla DX/SX c/ferro F1 q.8x65 espansione senza bocchetta



LV BG	OSC	
•	•	10

art. 66 HM



BG



BG

MEZZA MANIGLIA / HALF LEVER HANDLE

66 HM 416 Mezza maniglia art.66 c./ros. 416, con molla DX/SX senza ferro e senza bocchetta



LV BG	OSC	
•	•	10

MEZZA MANIGLIA / HALF LEVER HANDLE

66 HM 416/F1 Mezza maniglia art.66 c./ros. 416, con molla DX/SX c/ferro F1 q.8x65 espansione senza bocchetta



LV BG	OSC	
•	•	10

art. 37 HM



BG

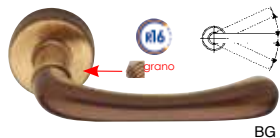

BG



MEZZA MANIGLIA / HALF LEVER HANDLE

37 HM 416 Mezza maniglia art.37c./ros. 416, con molla DX/SX senza ferro e senza bocchetta



LV
BG

OSC



•

•

10

MEZZA MANIGLIA / HALF LEVER HANDLE

37 HM 416/F1 Mezza maniglia art.37 c./ros. 416, con molla DX/SX c/ferro F1 q.8x65 espansione senza bocchetta



LV
BG

OSC



•

•

10

art. 104 HM



LV



LV



MEZZA MANIGLIA / HALF LEVER HANDLE

104 HM 416 Mezza maniglia art.104 c./ros. 416, con molla DX/SX senza ferro e senza bocchetta



LV
BG

OSC



•

•

10

MEZZA MANIGLIA / HALF LEVER HANDLE

104 HM 416/F1 Mezza maniglia art.104 c./ros. 416, con molla DX/SX c/ferro F1 q.8x65 espansione senza bocchetta



LV
BG

OSC



•

•

10

art. 276 HM



BG



BG



MEZZA MANIGLIA / HALF LEVER HANDLE

276 HM 416 Mezza maniglia art.276 c./ros. 416, con molla DX/SX senza ferro e senza bocchetta



BG



8,98

10

MEZZA MANIGLIA / HALF LEVER HANDLE

276 HM 416/F1 Mezza maniglia art.276 c./ros. 416, con molla DX/SX c/ferro F1 q.8x65 espansione senza bocchetta



BG



•

10

art. 31 RD - 31 RS



31 RD 062

LV



31 RD 062/F1

LV

MEZZA MANIGLIA / HALF LEVER HANDLE

31 RD 062 Mezza man.destra c/ros.062 c/molla e grano senza bocchetta - senza ferro
Half RH lever on cover screw rose 062 mm 82x62 with spring and grub screw without key rose



LV
BG

OSC

ZSC



•

•

•

10

31 RS 062 Mezza man.sinistra c/ros.062 c/molla e grano senza bocchetta - senza ferro
Half LH lever on cover screw rose 062 mm 82x62 with spring and grub screw without key rose

•

•

•

10

31 RD 062/F1 Mezza man.destra c/ros.062 c/molla e grano, q. 8x65 espansione senza bocchetta
Half RH lever on cover screw rose 062 mm 82x62 with spring and grub screw without key rose,
with expansion square spindle 8x65

•

•

•

10

31 RS 062/F1 Mezza man.sinistra c/ros.062 c/molla e grano, q. 8x65 espansione senza bocchetta
Half LH lever on cover screw rose 062 mm 82x62 with spring and grub screw without key rose,
with expansion square spindle 8x65

•

•

•

10

art. **CD7BY 001**

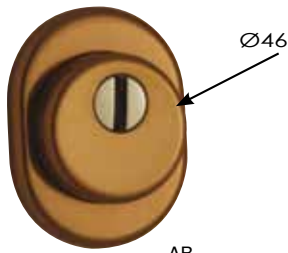

AB

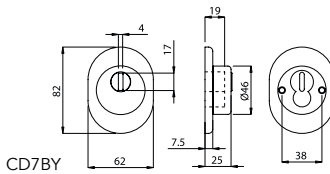

BOCCHETTA DI SICUREZZA

CD7 BY 001 Bocchetta di sicurezza esterna mm 82 x 62 con blocco DEFENDER ANTI TRAPANO Ø46 in acciaio CARBONITURATO - DUREZZA 60 ROCKWELL

ALL. BRONZO F4	ALL. ARGENTO F1	
•	•	1

art. **COPBY CD7**

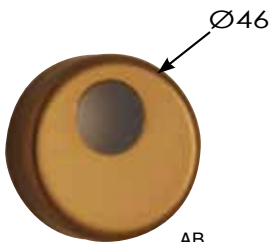

AB



AA

COPBYCD7

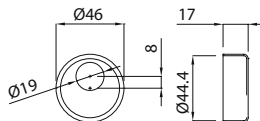

BOCCHETTA

COP BY CD7 COPRIDEFENDER Ø46

ALL. BRONZO F4	ALL. ARGENTO F1	
•	•	12

art. **CD7RO**



AB



AA

CD7 RO

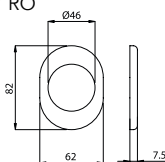

BOCCHETTA CON FORO

CD7 RO Rosetta coprivite mm 82x62 con foro ø46

ALL. BRONZO F4	ALL. ARGENTO F1	
•	•	12

art. **062RO**



AB

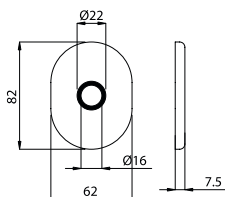

ROSETTA

062 RO Rosetta COPRIVITE mm 82 x 62 con foro tondo ø 16

ALL. BRONZO F4	ALL. ARGENTO F1	
•	•	12

art. 062BY



AA

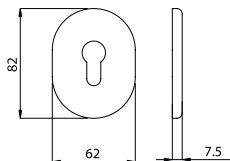

BOCCHETTA FORO YALE

062 BY Bocchetta COPRIVITE mm 82 x 62 con foro yale

ALL. BRONZO F4	ALL. ARGENTO F1	
•	•	12

art. 062DM



AA

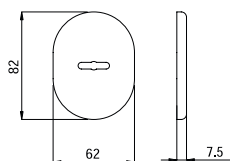

BOCCHETTA CON FORO DOPPIA MAPPA

062 DM Bocchetta COPRIVITE mm 82 x 62 con doppia mappa

ALL. BRONZO F4	ALL. ARGENTO F1	
•	•	12

art. 062BM



AA



Esempio di applicazione pomolino per limitatore di apertura su 062BN
Mounting example small knob for opening limiting device

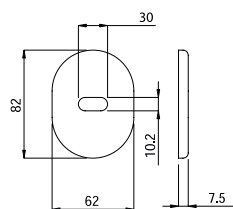

BOCCHETTA CON FORO CHIAVE ORIZZONTALE

062 BN Bocchetta COPRIVITE mm 82 x 62 per LIMITATORE DI APERTURA CON FUNZIONAMENTO A TRASLAZIONE POMOLINO ESCLUSO

ALL. BRONZO F4	ALL. ARGENTO F1	
•	•	12

art. 498 NN

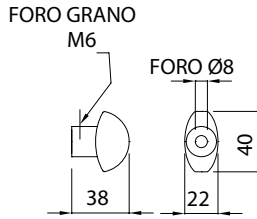
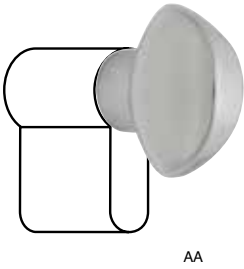

POMOLO PER CILINDRI CON CODOLO / KNOB FOR CYLINDER WITH TANG

498 NN Pomolo Farfalla per cilindro con foro Ø8 mm

ALL. BRONZO F4	ALL. ARGENTO F1	
•	•	12

art. C62 RO

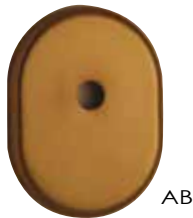

Esempio di applicazione pomolo per cilindro su C62 RO

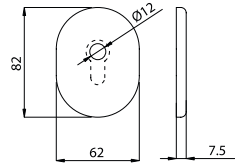

BOCCHETTA COPRIVITE

C62 RO Bocchetta COPRIVITE mm 82 x 62 con foro asse per cilindretti con codolo POMOLO ESCLUSO

ALL. BRONZO F4	ALL. ARGENTO F1	
•	•	12

art. 498 SP 062

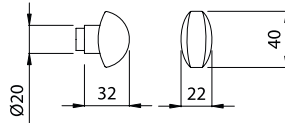

SEGRETTINO PICCOLO PER LIMITATORE DI APERTURA

498 SP 062 Segretino piccolo per LIMITATORE DI APERTURA con rosetta COPRIVITE 062 mm 82 x 62 con ferro q. 8 normale

ALL. BRONZO F4	ALL. ARGENTO F1	
•	•	12

art. 020 HM 062

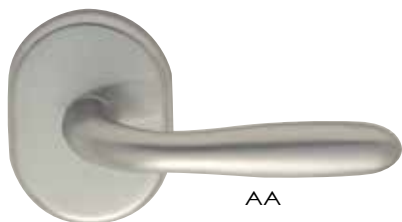

AA

020 HM 062



020 HM 062/F1



	ALL. BRONZO F4	ALL. ARGENTO F1	
MEZZA MANIGLIA / HALF LEVER HANDLE			
020 HM 062 Mezza maniglia art.020 c./ros. 062 mm 82x62 senza ferro e senza bocchetta	•	•	10
020 HM 062/F1 Mezza maniglia art.020 c./ros. 062 mm 82x62 c/ferro F1 q.8x65 espansione senza bocchetta	•	•	10

art. 020 HM 008

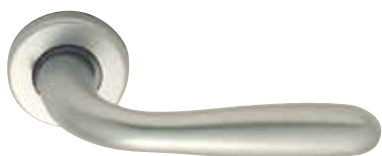

AA

020 HM 008



020 HM 008/F1



	ALL. BRONZO F4	ALL. ARGENTO F1	
MEZZA MANIGLIA / HALF LEVER HANDLE			
020 HM 008 Mezza maniglia art.020 c./ros. 008 senza ferro e senza bocchetta	•	•	12
020 HM 008/F1 Mezza maniglia art.020 c./ros. 062 mm 82x62 c/ferro F1 q.8x65 espansione senza bocchetta	•	•	12

art. 008 BY



AB

BOCCHETTA CON FORO YALE

008 BY

Bocchetta coprivite Ø50 foro yale



	ALL. BRONZO F4	ALL. ARGENTO F1
	•	•

COMPLEMENTI D'ARREDO
ASSORTED ACCESSORIES



art. 731 CA

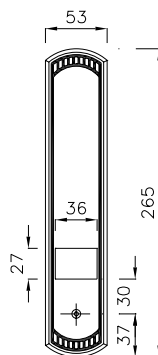

BS

BS



COPRIAVVOLGIBILE

731 CA

Copriavvolgibile universale
Roller blind cover

•

12

art. 831 CA



Extra per confezione self-service in blister
Extra for self-service blister packing

€ 2,95

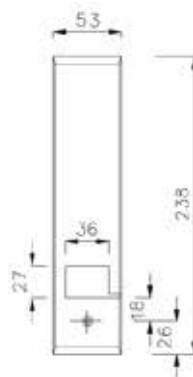

LV

BG

OC

OSC

LV
BG

OC
OSC



COPRIAVVOLGIBILE

831 CA

Copriavvolgibile universale
Roller blind cover

•

•

12

art. 649 RU

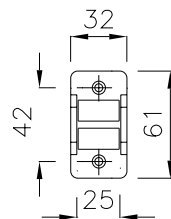
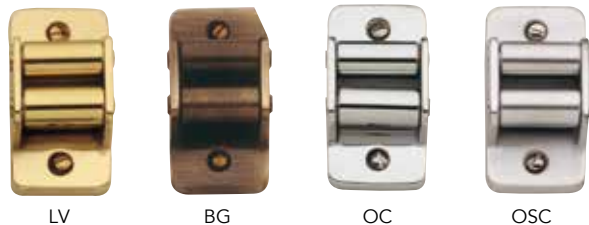

LV BG OC OSC

RULLINO SCORRICINGHIA

649 RU Rullino scorcinghia verticale
Vertical belt shifter



	LV BG	OC OSC	
	•	•	10
Extra per confezione self-service in blister Extra for self-service blister packing € 1,07			



art. 650 RU

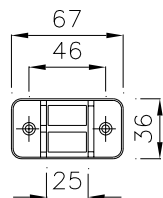

LV BG OC OSC

RULLINO SCORRICINGHIA

650 RU Rullino scorcinghia orizzontale
Horizontal belt shifter



	LV BG	OC OSC	
	•	•	10
Extra per confezione self-service in blister Extra for self-service blister packing € 1,07			



art. 450 CI - 451 CI - 452 CI - 453 CI - 454 CI - 455 CI



450 CI - LV 452 CI - BG

SERIE TICINO MAGIC

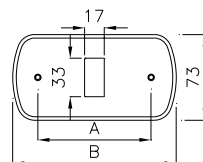

	A	B
450 CI	96,5	139
451 CI	96,5	139
452 CI	96,5	139
453 CI	96,5	139
454 CI	120	186
455 CI	144	186

COPRINTERRUTTORE TICINO MAGIC SCATOLA RETTANGOLARE

	LV BG	LS	AN	AGV	
450 CI Coprinterruttore cieco Switch cover without hole	•		•	•	12
451 CI Coprinterruttore 1 tasto Switch cover 1 hole	•		•	•	12
452 CI Coprinterruttore 2 tasti Switch cover 2 holes	•		•	•	12
453 CI Coprinterruttore 3 tasti Switch cover 3 holes	•		•	•	12
454 CI Coprinterruttore 4 tasti Switch cover 4 holes	•		•	•	12
455 CI Coprinterruttore 5 tasti Switch cover 5 holes	•		•	•	12



Extra per confezione self-service in blister
Extra for self-service blister packing € 1,21

art. 490 CI - 491 CI - 492 CI - 493 CI

SERIE VIMAR 8000



491 CI - LV



492 CI - BG



493 CI - AN

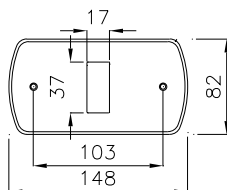

COPRINTERRUTTORE SERIE VIMAR 8000

		LV BG	LS	AN	
490 CI	Coprinterruttore cieco Switch cover without hole	•		•	12
491 CI	Coprinterruttore 1 tasto Switch cover 1 hole	•		•	12
492 CI	Coprinterruttore 2 tasti Switch cover 2 holes	•		•	12
493 CI	Coprinterruttore 3 tasti Switch cover 3 holes	•		•	12



Extra per confezione self-service in blister € 1,21
Extra for self-service blister packing

art. 550 CI - 551 CI - 552 CI - 553 CI

SERIE TICINO MAGIC



551 CI - BG



551 CI - OSC



551 CI - AGV

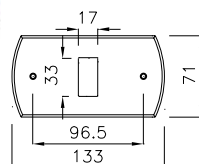

552 CI - LV



552 CI - OC



553 CI - AN



COPRINTERRUTTORE TICINO MAGIC

		LV BG	LS BS	OC OSC	AN BGO	AGV	RX	
550 CI	Coprinterruttore cieco Switch cover without hole	•		•	•	•	•	12
551 CI	Coprinterruttore 1 tasto Switch cover 1 hole	•		•	•	•	•	12
552 CI	Coprinterruttore 2 tasti Switch cover 2 holes	•		•	•	•	•	12
553 CI	Coprinterruttore 3 tasti Switch cover 3 holes	•		•	•	•	•	12



Extra per confezione self-service in blister € 1,21
Extra for self-service blister packing

art. 279 PA

CLG/LV



CLG/OSC

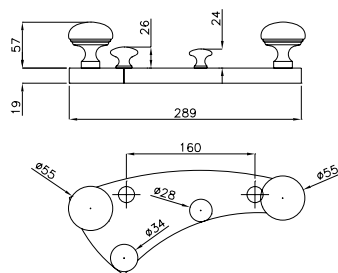

PORTABITO COMETA

279 PA

Portabito con base legno
Coat-hook on wood plate



CLG/LV	CLG/OC CLG/OSC	
•	•	1

art. 280 PA

LV



OC



OSC

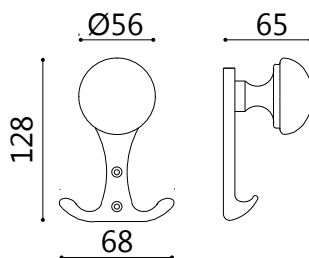

PORTABITO COSMO

280 PA

Portabito con pomolo Cosmo
Coat-hook with "Cosmo" knob



LV	OC OSC	
•	•	4

art. 290 PA



ZSV

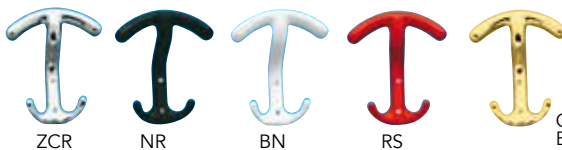
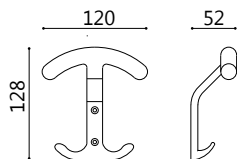

OTTONATO BRASSED

PORTABITO

290 PA

Portabito Coat-hook



OTTONATO	ZCR ZSV	BN NR RS	
•	•	•	8

art. 295 PA



OTTONATO BRASSED

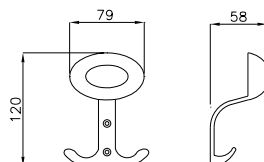

PORTABITO

295 PA

Portabito Coat-hook



OTTONATO	ZCR ZSV	BN NR RS	
•	•	•	36

art. 296 PA



OTTONATO BRASSED

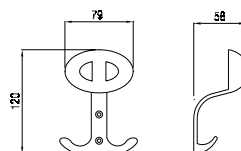

PORTABITO

296 PA

Portabito con finestra Coat-hook with holes



OTTONATO	ZCR	BN NR RS	
•	•	•	36

art. 297 PA



BN



NR



RS

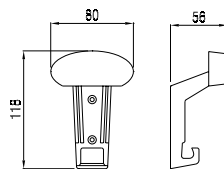

PORTABITO

297 PA

Portabito nylon
Nylon Coat-hook



BN	NR	RS	
•	•	•	36

art. 298 PA



BN/LV



NR/OSC



NR/LV



RS/LV

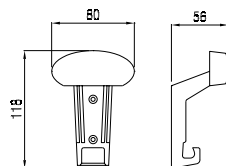

PORTABITO

298 PA

Portabito nylon con inserto in ottone
Nylon Coat-hook with brass item



BN/LV NR/LV RS/LV	BN/OSC NR/OSC RS/OSC	
•	•	36

art. 300 PA



LV



OC

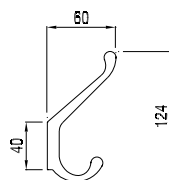

PORTABITO

300 PA

Portabito
Coat-hook



LV	OC	
•	•	25



Extra per confezione self-service in blister € 1,21
Extra for self-service blister packing

art. 303 PA



OSC

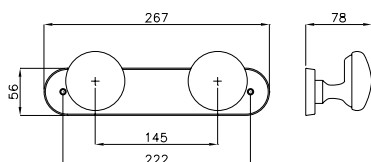

LV

PORTABITO

303 PA

Portabito a 2 posti
Coat-hook with 2 places



LV	OSC	PVD	
•	•	•	1

art. 304 PA



OSC/OC

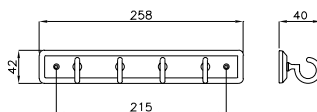

OL



OC

PORTABITO

304 PA

Portabito a 4 posti
Coat-hook with 4 places



OL	LV	OC	OSC/OC	
•	•	•	•	6



Extra per confezione self-service in blister € 2,95
Extra for self-service blister packing

art. 305 PA

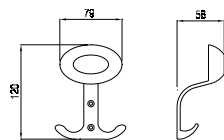

PORTABITO

305 PA

Portabito
Coat-hook



LV BG	OSC	AN	AGV	
•	•	•	•	12

art.608 GA



	L1	L2	L3
608 GA 034	34	14	22
608 GA 041	41	14	30
608 GA 046	46	17	38

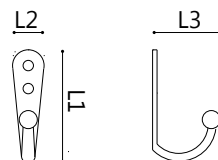

GANCIO SEMPLICE

608 GA 034	Gancio semplice tipo piccolo Simple hook small type
608 GA 041	Gancio semplice tipo medio Simple hook middle type
608 GA 046	Gancio semplice tipo grande Simple hook big type



OL	OB	OC BN	
•	•	•	100
•	•	•	100
•	•	•	100



Extra per confezione self-service in blister da 2 pz. € 1,21
Extra for self-service blister packing 2 pcs.
Esempio: € 1,21 + prezzo articolo x2
Example: € 1,21 + item price x2



Extra per confezione self-service in skin pack da 4 pz. € 1,21
Extra for self-service packaging in skin pack 4 pcs.
Esempio: € 1,21 + prezzo articolo x4
Example: € 1,21 + item price x4

art.609 GA

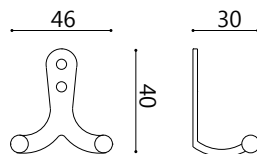
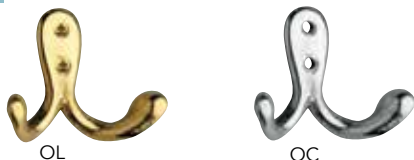

GANCIO DOPPIO

609 GA

Gancio doppio
Double hook



OL	OB	OC BN	
•	•	•	100



Extra per confezione self-service in blister da 2 pz. € 1,21
Extra for self-service blister packing 2 pcs.
Esempio: € 1,21 + prezzo articolo x2
Example: € 1,21 + item price x2



Extra per confezione self-service in skin pack da 4 pz. € 1,21
Extra for self-service packaging in skin pack 4 pcs.
Esempio: € 1,21 + prezzo articolo x4
Example: € 1,21 + item price x4

art.610 GA

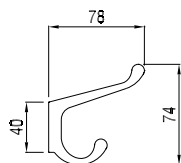
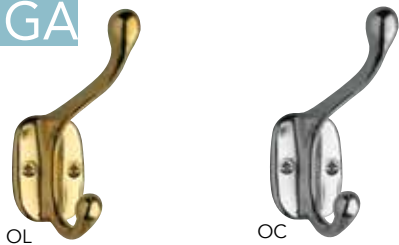

GANCIO LISCIO

610 GA

Gancio liscio
Smooth hook



	OL	OC BN	
	•	•	25



Extra per confezione self-service in blister
Extra for self-service blister packing € 1,21

art.612 GA



	L1	L2
612 GA 045	45	20
612 GA 055	55	25
612 GA 075	75	32
612 GA 100	100	48

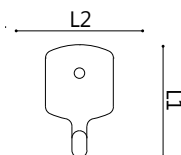

GANCIO FIORENTINO

612 GA 045

Gancio fiorentino mm 45
Fiorentino hook mm 45

612 GA 055

Gancio fiorentino mm 55
Fiorentino hook mm 55

612 GA 075

Gancio fiorentino mm 75
Fiorentino hook mm 75

612 GA 100

Gancio fiorentino mm 100
Fiorentino hook mm 100



	OL	OB	OC BN	
	•	•	•	100
	•	•	•	100
	•	•	•	100
	•	•	•	50

Extra per confezione self-service in blister da 2 pz.
Extra for self-service blister packing 2 pcs. € 1,21
Esempio: € 1,21 + prezzo articolo x2
Example: € 1,21 + item price x2



Extra per confezione self-service in skin pack da 4 pz.
Extra for self-service packaging in skin pack 4 pcs. € 1,21
Esempio: € 1,21 + prezzo articolo x4
Example: € 1,21 + item price vx4

art.613 GA

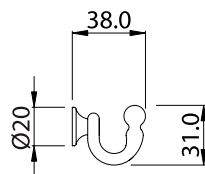

GANCIO OTTONE BILL

613 GA

Gancio ottone con vite
Brass small hook with screw



	OL	OB	OC	OSC	
	•	•	•	•	100



Extra per confezione self-service in blister da 2 pz.
Extra for self-service blister packing 2 pcs. € 1,21
Esempio: € 1,21 + prezzo articolo x2
Example: € 1,21 + item price x2



Extra per confezione self-service in skin pack da 4 pz.
Extra for self-service packaging in skin pack 4 pcs. € 1,21
Esempio: € 1,21 + prezzo articolo x4
Example: € 1,21 + item price x4

art.624 GA



	D	L1	L2
624 GA 030	11	30	24
624 GA 040	15	40	30

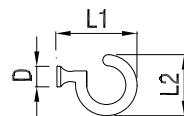

GANCIO OTTONE

624 GA 030	Gancio ottone con vite tipo piccolo Brass hook with screw small type
624 GA 040	Gancio ottone con vite tipo grande Brass hook with screw big type



	OL	OB	OC	
	•	•	•	100
	•	•	•	100



Extra per confezione self-service in blister da 2 pz. € 1,21
Extra for self-service blister packing 2 pcs.
Esempio: € 1,21 + prezzo articolo x2
Example: € 1,21 + item price x2



Extra per confezione self-service in skin pack da 4 pz. € 1,21
Extra for self-service packaging in skin pack 4 pcs.
Esempio: € 1,21 + prezzo articolo x4
Example: € 1,21 + item price x4

art.105 MT

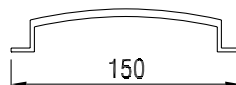
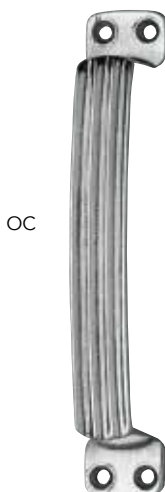

MANETTONCINO RIGATO

105 MT 150	Manettoncino Rigato mm 150 Fluted Small Handle mm 150
------------	--



	OL	OC OB	
	•	•	12



Extra per confezione self-service in blister
Extra for self-service blister packing € 1,21

art.106 MT

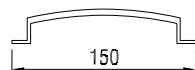
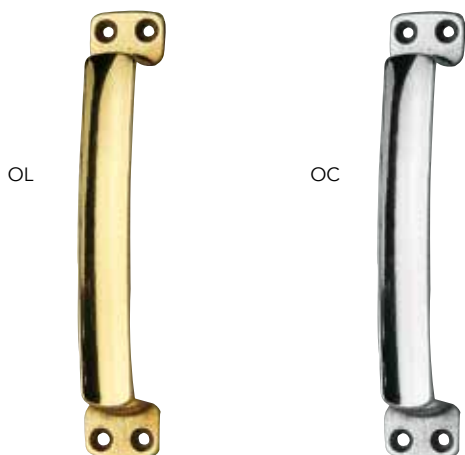

MANETTONCINO SCANALATO

106 MT 150 Manettoncino Scanalato mm 150
Channelled Small Handle mm 150



OL	OC OB	
•	•	12



Extra per confezione self-service in blister
Extra for self-service blister packing € 1,21

art.109 MT



	L
109 MT 090	90
109 MT 110	110
109 MT 130	130
109 MT 140	140

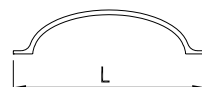

MANETTINA

109 MT 090 Manettina per mobili mm 90
Small Handle mm 90

109 MT 110 Manettina per mobili mm 110
Small Handle mm 110

109 MT 130 Manettina per mobili mm 130
Small Handle mm 130

109 MT 140 Manettina per mobili mm 140
Small Handle mm 140



OL	OC OB	
•	•	100
•	•	100
•	•	100
•	•	100



Extra per confezione self-service in blister
Extra for self-service blister packing € 1,21

art.114 MT



LV



BF



AN



AGV

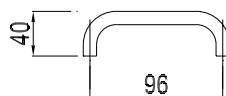

MANETTONCINO

114 MT 096

Manettoncino int. mm 96 fil. 4MA
Small Handle centre distance mm 96 thread mm 4MA



LV	BF	AN	AGV	
•	•	•	•	12



Extra per confezione self-service in blister
Extra for self-service blister packing € 1,21

art.309 MT



309 MT 180 LV



309 MT 150 OC

	L
309 MT 150	150
309 MT 180	180

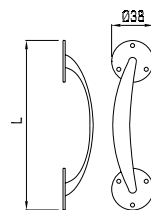

MANETTONCINO SPOSTATO CON FORI VITI

309 MT 150

Manettoncino mm150 con base Ø38
Small Handle mm150 with base Ø38

309 MT 180

Manettoncino mm180 con base Ø38
Small Handle mm180 with base Ø38



LV	OC	
•	•	12
•	•	12



Extra per confezione self-service in blister
Extra for self-service blister packing € 1,21

art.515 MT

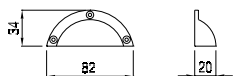

LV



AN



AGV



VBN

MANETTINA PER MOBILI

515 MT 085

Manettina per mobili mm 20
Small Handle mm 20



LV	BG	AN	AGV	VBN	
•	•	•	•	•	24



Extra per confezione self-service in blister
Extra for self-service blister packing € 1,07

art.516 MT



516 MT 051 - LV



516 MT 038 - OSC



516 MT 038 - AN



516 MT 038 - AGV

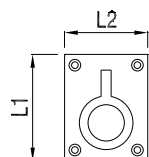

	L1	L2
516 MT 038	52	38
516 MT 051	64	51

MANETTINA AD INCASSO

516 MT 038

Manettina ad incasso con anello tipo Marina Militare mm 38x52
Military chest handle mm 38x52

516 MT 051

Manettina ad incasso con anello tipo Marina Militare mm 51x64
Military chest handle mm 51x64



LV	BG	OC OSC	AN	AGV	
•	•	•	•	•	24
•	-	-	-	-	24



Extra per confezione self-service in blister
Extra for self-service blister packing € 1,07

art.518 MT

LV

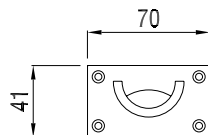

MANETTINA AD INCASSO

518 MT 070

Manettina ad incasso con anello tipo Marina Militare mm 70x41
Military chest handle mm 70x41



LV	
5,49	24



Extra per confezione self-service in blister
Extra for self-service blister packing € 1,07

art. 121 PN



	D	L
121 PN 022	22	21
121 PN 028	28	24
121 PN 034	34	26
121 PN 040	40	29

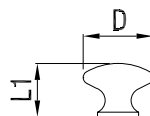

121 PN 287-LV



OC



OSC



AN



AGV



POMOLINO SPIDY

121 PN 022	Pomolino mm 22 Small Knob mm 22
121 PN 028	Pomolino mm 28 Small Knob mm 28
121 PN 034	Pomolino mm 34 Small Knob mm 34
121 PN 040	Pomolino mm 40 Small Knob mm 40
121 PN 287	Pomolino mm 28 su rosetta 007 Small Knob mm 28 on rose 007



	LV OB	OC OSC	AN	AGV NC	
	•	•	•	•	24
	•	•	•	•	24
	•	•	•	•	24
	•	•	•	•	24
	•	•	•	•	24



Extra per confezione self-service in blister da 2 pz. €1,21
Extra for self-service blister packing 2 pcs.
Esempio: € 1,21 + prezzo articolo x2

art. 122 PN



	D	L
122 PN 020	20	27
122 PN 025	25	32
122 PN 030	30	38

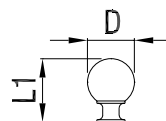

122 PN 257-LV



OC



OSC



AN



AGV



POMOLINO SFERA

122 PN 020	Pomolino mm 20 Small Knob mm 20
122 PN 025	Pomolino mm 25 Small Knob mm 25
122 PN 030	Pomolino mm 30 Small Knob mm 30
122 PN 257	Pomolino mm 25 su rosetta 007 Small Knob mm 25 on rose 007



	LV BG	OC OSC	AN	AGV	
	•	•	•	•	24
	•	•	•	•	24
	•	•	•	•	24
	•	•	•	•	24



Extra per confezione self-service in blister da 2 pz. €1,21
Extra for self-service blister packing 2 pcs.
Esempio: € 1,21 + prezzo articolo x2

art. 123 PN

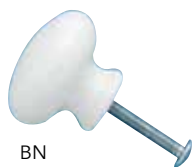

BN



123 PN 038 SO



123 PN 025 SO

	D	L
123 PN 025	25	24
123 PN 038	38	28

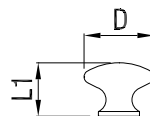

POMOLINO IN PORCELLANA

		BN	SO	
123 PN 025	Pomolino in porcellana mm 25 Small porcelain Knob mm 25	•	•	24
123 PN 030	Pomolino in porcellana mm 30 Small porcelain Knob mm 30	•	•	24
123 PN 038	Pomolino in porcellana mm 38 Small porcelain Knob mm 38	•	•	24



Extra per confezione self-service in blister da **2 pz.** €1,21
 Extra for self-service blister packing **2 pcs.**
 Esempio: € 1,21 + prezzo articolo x2

art. 124 PN



124 PN 025 OSC



124 PN 025 OC

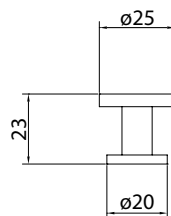

POMOLINO Q.

		LV	OC	OSC	
124 PN 025	Pomolino quadrato mm 25X25 Small Square Knob mm 25X25	•	•	•	24



Extra per confezione self-service in blister da **2 pz.** €1,21
 Extra for self-service blister packing **2 pcs.**
 Esempio: € 1,21 + prezzo articolo x2

art. 126 PN



BN



BN



126 PN 042 SO



126 PN 034 SO

	L2	L1
126 PN 034	34+23	21
126 PN 042	42+28	23

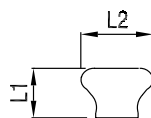

POMOLINO OVALE

126 PN 034	Pomolino in porcellana mm 34x23 Small porcelain Knob mm 34x23
126 PN 042	Pomolino in porcellana mm 42x28 Small porcelain Knob mm 42x28



	BN	SO	
	•	•	24
	•	•	24



Extra per confezione self-service in blister da 2 pz. € 1,21
Extra for self-service blister packing 2 pcs. € 1,21
Esempio: € 1,21 + prezzo articolo x2

art. 130 PN



BN/OB



BN/OL

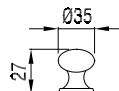

POMOLINO IN PORCELLANA

130 PN 035	Pomolino in porcellana con inserto in ottone mm 35 Small porcelain Knob with item in brass mm 35
------------	---



	BN/OL	BN/OB	
	•	•	36



Extra per confezione self-service in blister da 2 pz. € 1,21
Extra for self-service blister packing 2 pcs. € 1,21
Esempio: € 1,21 + prezzo articolo x2

art. 136 PN



BN/OB



BN/OL

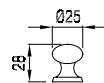

POMOLINO IN PORCELLANA

136 PN 025	Pomolino in porcellana con inserto in ottone mm 25 Small porcelain Knob with item in brass mm 25
------------	---



	BN/OL	BN/OB	
	•	•	36



Extra per confezione self-service in blister da 2 pz. € 1,21
Extra for self-service blister packing 2 pcs. € 1,21
Esempio: € 1,21 + prezzo articolo x2

art. 137 PN



DEC.C

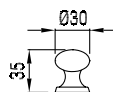

POMOLINO IN PORCELLANA

137 PN 030

Pomolino in porcellana mm 30
Small porcelain Knob mm 30



DEC.C



36



Extra per confezione self-service in blister da 2 pz. € 1,21
Extra for self-service blister packing 2 pcs.
Esempio: € 1,21 + prezzo articolo x2

art. 153 PN



LV

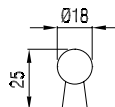

POMOLINO

153 PN 018

Pomolino mm 18
Small Knob mm 18



LV



50



Extra per confezione self-service in blister da 2 pz. € 1,21
Extra for self-service blister packing 2 pcs.
Esempio: € 1,21 + prezzo articolo x2

art. 157 PN



LV



OSC



POMOLINO

157 PN 013

Pomolino mm 13
Small Knob mm 13



LV

OSC



50



Extra per confezione self-service in blister da 2 pz. € 1,21
Extra for self-service blister packing 2 pcs.
Esempio: € 1,21 + prezzo articolo x2

art. 159 PN

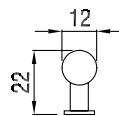

POMOLINO

159 PN 012

Pomolino mm 12
Small Knob mm 12



LV		
•		50



Extra per confezione self-service in blister da 2 pz. € 1,21
Extra for self-service blister packing 2 pcs.
Esempio: € 1,21 + prezzo articolo x2

art. 165 PN



LV



OC

	D	L	B
165 PN 020	20	27	20
165 PN 025	25	33	25
165 PN 030	30	39	30

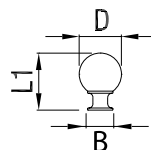

POMOLINO CON BASE

165 PN 020

Pomolino mm 20
Small Knob mm 20

165 PN 025

Pomolino mm 25
Small Knob mm 25

165 PN 030

Pomolino mm 30
Small Knob mm 30



LV	OC OSC	
•	•	50
•	•	30
•	•	30



Extra per confezione self-service in blister da 2 pz. € 1,21
Extra for self-service blister packing 2 pcs.
Esempio: € 1,21 + prezzo articolo x2

art. 166 PN



LV

	D	L	B
166 PN 020	20	20	20
166 PN 025	25	25	25
166 PN 030	30	30	30
166 PN 035	35	32	35

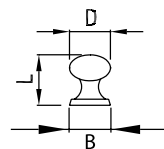

POMOLINO CON BASE

166 PN 020

Pomolino mm 20
Small Knob mm 20

166 PN 025

Pomolino mm 25
Small Knob mm 25

166 PN 030

Pomolino mm 30
Small Knob mm 30

166 PN 035

Pomolino mm 35
Small Knob mm 35



LV	BG	OC OSC	
•	•	•	50
•	•	•	30
•	•	•	30
•	•	•	30



Extra per confezione self-service in blister da 2 pz. € 1,21
Extra for self-service blister packing 2 pcs.
Esempio: € 1,21 + prezzo articolo x2



ESEMPIO DI CORRIMANO IN OPERA
INSTALLATION EXAMPLE OF HAND RAIL BRACKET

SUPPORTI PER BALAUSTRE / BANISTERS HANDRAIL BRACKET
vedi art. 674-675-676-677-678
see art. 674-675-676-677-678



ESEMPIO DI CORRIMANO IN OPERA
INSTALLATION EXAMPLE OF HAND RAIL BRACKET
vedi art. 330/335 TU + 658 SU + 653 SU
see art. 330/335 TU + 658 SU + 653 SU

art. 622 SU



LV



OB



OC



OSC

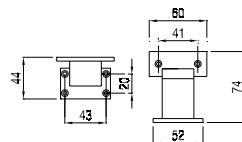

SUPPORTO / BRACKET

622 SU

Supporto con fori per viti - appoggio piano
Bracket with holes for screws - flat support



OL	LV	OC OSC	OB LEV	
•	•	•	8,31	12



Extra per confezione self-service in blister
Extra for self-service blister packing

€ 1,21

art. 623 SU



LV



OB



OC



OSC

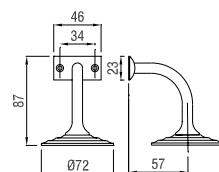

SUPPORTO CON APPOGGIO PIANO / BRACKET WITH FLAT SUPPORT

623 SU

Supporto con rosetta Ø72 e vite M10x 80
Bracket with rose Ø72 and screw M10x80



OL	LV OB	OC OSC	
•	•	•	12

art. 627 SU



LV



OB



OC



OSC

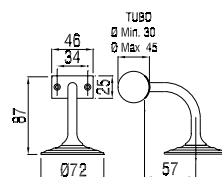

SUPPORTO CON APPOGGIO TONDO / BRACKET WITH ROUND SUPPORT

627 SU

Supporto con rosetta Ø72 e vite M10x 80
Bracket with rose Ø72 and screw M10x80



OL	LV OB	OC OSC	
•	•	•	12

art. 628 SU



SUPPORTO CON APPOGGIO PIANO / BRACKET WITH FLAT SUPPORT
628 SU

Supporto con rosetta Ø60 fissa con 3 fori viti
Bracket with fixed rosette Ø60 and 3 holes for screws



OL	LV OB	OC OSC	
•	•	•	12

art. 629 SU



SUPPORTO CON APPOGGIO TONDO / BRACKET WITH ROUND SUPPORT
629 SU

Supporto con rosetta Ø60 fissa con 3 fori viti
Bracket with fixed rosette Ø60 and 3 holes for screws



OL	LV OB	OC OSC	
•	•	•	12

art. 630 SU



SUPPORTO CON APPOGGIO PIANO / BRACKET WITH FLAT SUPPORT
630 SU

Supporto con base Ø45 e vite M10 x 80
Bracket with base Ø45 and screw M10 x 80



OL	LV OB	OC OSC	
•	•	•	12



Extra per confezione self-service in blister
Extra for self-service blister packing

€ 1,21

art. 631 SU

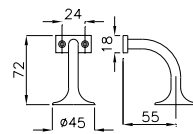

SUPPORTO CON APPOGGIO PIANO / BRACKET WITH FLAT SUPPORT

631 SU

Supporto con base Ø45 e con 3 fori viti
Bracket with base Ø45 and 3 holes for screws



OL	LV OB	OC OSC	
•	•	•	12



Extra per confezione self-service in blister
Extra for self-service blister packing

€ 1,21

art. 640 SU

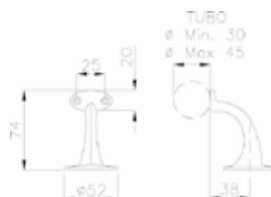

SUPPORTO PER CORRIMANO AD APPOGGIO TONDO / BRACKET WITH ROUND SUPPORT

640 SU

Supporto con base Ø50 e vite M10 x 80
Bracket with base Ø50 and screw M10 x 80



OL	LV OB	OC OSC	LEV	
•	•	•	•	12

art. 653 SU



	d	D
653 SU 030	30,5	47
653 SU 035	35,5	52

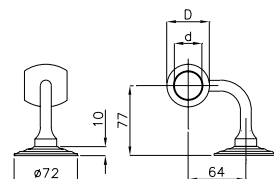

SUPPORTO PER CORRIMANO / HAND RAIL BRACKET

653 SU 030

Supporto per tubo Ø 30 con rosetta Ø72 e vite M10 x 80
Bracket Ø 30 with rose Ø72 and screw M10 x 80

653 SU 035

Supporto per tubo Ø 35 con rosetta Ø72 e vite M10 x 80
Bracket Ø 35 with rose Ø72 and screw M10 x 80



LV OB	OC OSC	
•	•	6
•	•	6

art. 654 SU



LV



OC

	d	D
654 SU 030	30,5	47
654 SU 035	35,5	52

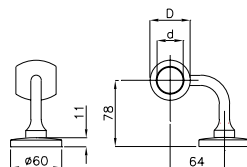

SUPPORTO PER CORRIMANO / HAND RAIL BRACKET		LV	OC OSC	
654 SU 030	Supporto per tubo Ø 30 con rosetta Ø60 fissa con 3 fori viti Bracket Ø 30 with fixed rosette Ø60 and 3 holes for screws	•	•	6
654 SU 035	Supporto per tubo Ø 35 con rosetta Ø60 fissa con 3 fori viti Bracket Ø 35 with fixed rosette Ø60 and 3 holes for screws	•	•	6

art. 655 SU



LV



OC

	d	D
655 SU 030	30,5	47
655 SU 035	35,5	52

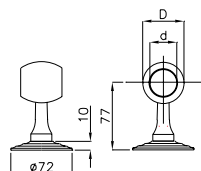

SUPPORTO PER CORRIMANO / HAND RAIL BRACKET		LV OB	OC OSC	
655 SU 030	Supporto diritto per tubo Ø 30 con rosetta Ø72 e vite M10 x 80 Bracket Ø 30 with rose Ø72 and screw M10 x 80	•	•	6
655 SU 035	Supporto diritto per tubo Ø 35 con rosetta Ø72 e vite M10 x 80 Bracket Ø 35 with rose Ø72 and screw M10 x 80	•	•	6

art. 656 SU



LV



OC

	d	D
656 SU 030	30,5	47
656 SU 035	35,5	52

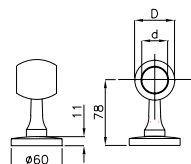

SUPPORTO PER CORRIMANO / HAND RAIL BRACKET		LV OB	OC OSC	
656 SU 030	Supporto diritto per tubo Ø 30 con rosetta Ø60 fissa con 3 fori viti Bracket Ø 30 with fixed rosette Ø60 and 3 holes for screws	•	•	6
656 SU 035	Supporto diritto per tubo Ø 35 con rosetta Ø60 fissa con 3 fori viti Bracket Ø 35 with fixed rosette Ø60 and 3 holes for screws	•	•	6

art. 658 NL



LV



OC

	d	D
658 NL 030	30,5	45
658 NL 035	35,5	52

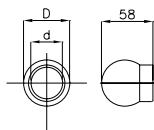

FINALE PER TUBO / FINAL FOR PIPE

658 NL 030	Finale per tubo Ø30 con grano Final Ø30 with grub screw		LV OB	OC OSC	
658 NL 035	Finale per tubo Ø35 con grano Final Ø35 with grub screw				

art. 666 NL



LV



OB



retro

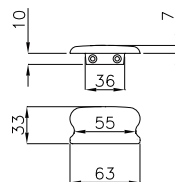

FINALE SAGOMATO PER CORRIMANO IN LEGNO/ SHAPED FINAL FOR WOOD HAND-RAIL

666 NL	Finale sagomato da mm 63x33 con viti Shaped final mm 63x33 with screws		LV OB	
	Extra per confezione self-service in blister Extra for self-service blister packing		•	12

€ 1,07

art. 674 SU



LV



OC

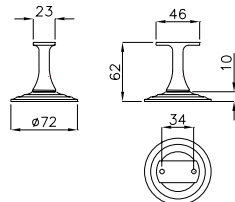

SUPPORTO CON APPOGGIO PIANO / BRACKET WITH FLAT SUPPORT

674 SU	Supporto diritto con rosetta Ø72 e vite M10 x 80 Bracket with rose Ø72 and screw M10 x 80		LV OB	OC OSC	
			•	•	12

art. 675 SU

LV



OC

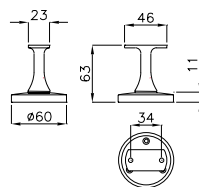

SUPPORTO CON APPOGGIO PIANO / BRACKET WITH FLAT SUPPORT

675 SU

Supporto con rosetta Ø60 fissa con 3 fori vite
Bracket with fixed rosette Ø60 and 3 holes for screws



LV OB	OC OSC	
•	•	12

art. 676 SU

LV



OC

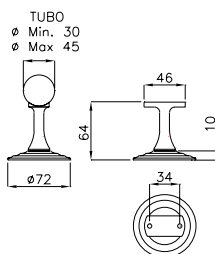

SUPPORTO CON APPOGGIO TONDO / BRACKET WITH ROUND SUPPORT

676 SU

Supporto diritto con rosetta Ø72 e vite M10 x 80
Bracket with rose Ø72 and screw M10 x 80



LV OB	OC OSC	
•	•	12

art. 677 SU

LV



OC

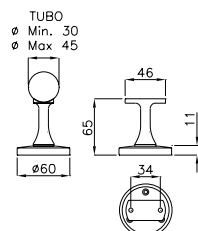

SUPPORTO CON APPOGGIO TONDO / BRACKET WITH ROUND SUPPORT

677 SU

Supporto diritto con rosetta Ø60 fissa con 3 fori vite
Bracket with fixed rosette Ø60 and 3 holes for screws



LV OB	OC OSC	
•	•	12

art. 678 SU

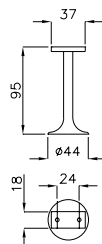

SUPPORTO CON APPOGGIO PIANO / BRACKET WITH FLAT SUPPORT

678 SU

Supporto diritto mm 95 - con vite M10 x 80
Bracket with screw M10 x 80



LV OB	OC	OSC	
•	•		12



Extra per confezione self-service in blister
Extra for self-service blister packing

€ 1,21

art. 683 SU

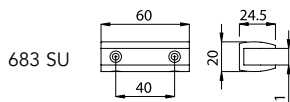

683 SU-OSC

SUPPORTI PORTA MENSOLA PER CRISTALLO / BRACKET FOR CRYSTAL

683 SU

Supporto porta mensola lunghezza mm 60 con 2 viti di fermo
Shelf bracket length mm 60 with 2 stop screws



LV	OC OSC	SNV	
•	•	•	12



Extra per confezione self-service in blister
Extra for self-service blister packing

€ 1,21

art. 330 TU - 335 TU

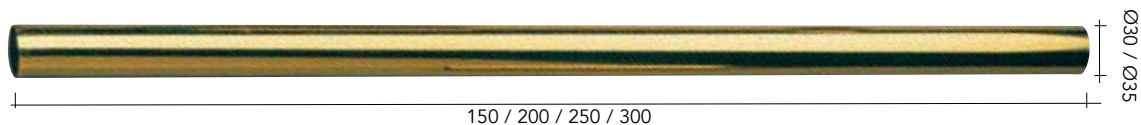

TUBO OTTONE / BRASS PIPE		+6%	LV	
330 TU 150	Tubo ottone Ø30 x mm 1 (spessore) - cm 150 Brass pipe Ø30 x mm 1 (thickness) - cm 150		•	1
330 TU 200	Tubo ottone Ø30 x mm 1 (spessore) - cm 200 Brass pipe Ø30 x mm 1 (thickness) - cm 200		•	1
330 TU 250	Tubo ottone Ø30 x mm 1 (spessore) - cm 250 Brass pipe Ø30 x mm 1 (thickness) - cm 250		•	1
330 TU 300	Tubo ottone Ø30 x mm 1 (spessore) - cm 300 Brass pipe Ø30 x mm 1 (thickness) - cm 300		•	1
TUBO OTTONE / BRASS PIPE				
335 TU 150	Tubo ottone Ø35 x mm 1 (spessore) - cm 150 Brass pipe Ø35 x mm 1 (thickness) - cm 150		•	1
335 TU 200	Tubo ottone Ø35 x mm 1 (spessore) - cm 200 Brass pipe Ø35 x mm 1 (thickness) - cm 200		•	1
335 TU 250	Tubo ottone Ø35 x mm 1 (spessore) - cm 250 Brass pipe Ø35 x mm 1 (thickness) - cm 250		•	1
335 TU 300	Tubo ottone Ø35 x mm 1 (spessore) - cm 300 Brass pipe Ø35 x mm 1 (thickness) - cm 300		•	1

art. 331 TU

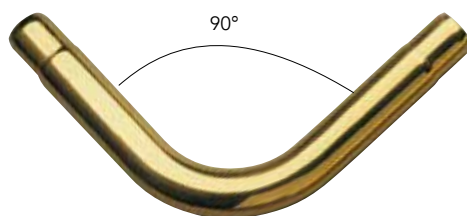

TUBO OTTONE / BRASS PIPE		+6%	LV	
331 TU 090	Tubo ottone Ø30 curva ad angolo 90° Brass pipe Ø30 - angle 90°		•	6

art. 332 TU - 337 TU

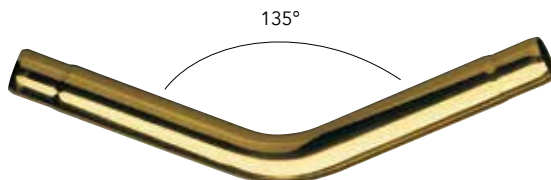

TUBO OTTONE / BRASS PIPE		+6%	LV	
332 TU 135	Tubo ottone Ø30 curva ad angolo 135° Brass pipe Ø30 - angle 135°		•	6
TUBO OTTONE / BRASS PIPE				
337 TU 135	Tubo ottone Ø35 curva ad angolo 135° Brass pipe Ø35 - angle 135°		64,23	6

art. 702 NP



NUMERI DA 40 CON PIOLI / NUMBERS MM 40 WITH PINS

702 NP

Numeri da 0 a 8 mm 40
Numbers from 0 to 8 mm 40



OL



•

24



Extra per confezione self-service in blister
Extra for self-service blister packing

€ 1,07

art. 714 LP



LETTERE DA 40 CON PIOLI / LETTERS MM 40 WITH PINS

714 LP

Lettere da A a Z mm 40
Letters from A to Z mm 40



OL



•

24



Extra per confezione self-service in blister
Extra for self-service blister packing

€ 1,07

art. 705 NP



NUMERI DA 80 CON PIOLI / NUMBERS MM 80 WITH PINS

705 NP

Numeri da 0 a 8 mm 80
Numbers from 0 to 8 mm 80



OL



•

12



Extra per confezione self-service in blister
Extra for self-service blister packing

€ 1,21

art. 717 LP



LETTERE DA 80 CON PIOLI / LETTERS MM 80 WITH PINS

717 LP Lettere da A a Z mm 80
Letters from A to Z mm 80

OL		
•		12



Extra per confezione self-service in blister
Extra for self-service blister packing € 1,21

art. 705 NU



OSC



BS



NUMERI DA 80 CON FORI PER VITI / NUMBERS MM 80 WITH HOLES FOR SCREWS

705 NU Numeri da 0 a 8 mm 80
Numbers from 0 to 8 mm 80

OL	BS	OC OSC	
•	•	•	12



Extra per confezione self-service in blister
Extra for self-service blister packing € 1,21

art. 717 LE



OC

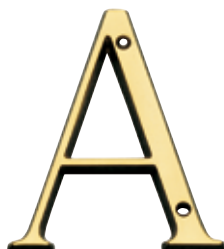

BL



LETTERE DA 80 CON FORI PER VITI / LETTERS MM 80 WITH HOLES FOR SCREWS

717 LE Lettere A - B - C - D mm 80
Letters A - B - C - D mm 80

717 LE Lettere da E a Z mm 80
Letters from E to Z mm 80

OL	BS	LV	BL	OC OSC	
•	•	•	•	•	12
•					



Extra per confezione self-service in blister
Extra for self-service blister packing € 1,21

art.706 NU



OSC



BL



NUMERO DA 120 CON FORI PER VITI / NUMBERS MM 120 WITH HOLES FOR SCREWS

706 NU

Numeri da 0 a 8 mm 120
Numbers from 0 to 8 mm 120

OL	BS	LV	BL	OC OSC	
•	•	•	•	•	12



Extra per confezione self-service in blister
Extra for self-service blister packing

€ 1,61

art.599 VM



AN



OSC

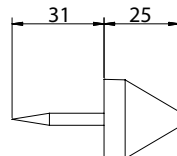
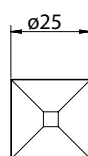

CHIODI A PIRAMIDE/ PYRAMID STUDS

599 VM 025

Chiodo a piramide mm 25X25
Stud mm 25X25



LR VBN	LV BG	AN	AGV	OSC	
•	•	•	•	•	24

art.698 VM



LV



AN



AGV



OSC

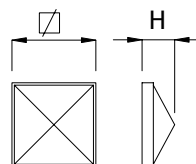

	□	H
698 VM 025	25	9
698 VM 030	30	13
698 VM 035	35	14

BORCHIE A PIRAMIDE/ PYRAMID STUDS

698 VM 025

Borchia a piramide mm 25 con vite
Stud mm 25 with screw

698 VM 030

Borchia a piramide mm 30 con vite
Stud mm 30 with screw

698 VM 035

Borchia a piramide mm 35 con vite
Stud mm 30 with screw



LV	VBN	AN	AGV	OSC	
•	•	•	•	•	24
•	•	•	•	•	24
•	•	•	•	•	24



Extra per confezione self-service in blister
Extra for self-service blister packing

€ 1,21

art.641 VM

CROMATO
CHROME

OTTONATO
BRASSED



645 VM

643 VM

642 VM

641 VM



PIEDINI REGOLABILI / ADJUSTABLE SUPPORTS WITH THREAD		OTTONATO	CROMATO	
641 VM 010	Piedino regolabile Ø25 fil M10 - h mm 30 Adjustable supports Ø25 with thread M10 - high mm 30	•	•	100
642 VM 008	Piedino regolabile Ø30 fil M8 - h mm 31 Adjustable supports Ø30 with thread M8 - high mm 31		•	100
642 VM 010	Piedino regolabile Ø30 fil M10 - h mm 31 Adjustable supports Ø30 with thread M10 - high mm 31		•	100
643 VM 010	Piedino regolabile Ø35 fil M10 - h mm 32 Adjustable supports Ø35 with thread M10 - high mm 32	•		50
645 VM 012	Piedino regolabile Ø50 fil M12 - h mm 45 Adjustable supports Ø50 with thread M12 - high mm 45	•		50



Extra per confezione self-service in blister da 2 pz. € 1,21
Extra for self-service blister packing 2 pcs.
Esempio: € 1,21 + prezzo articolo x2
Example: € 1,21 + item price x2

art.426 NT



426 NT-OL

	H
426 NT 020	20
426 NT 025	25
426 NT 030	30

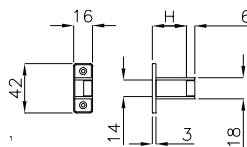

PASSANTE A RULLO PER FINESTRA / ROLLING LOOP FITTING		OL	OB	OC	
426 NT 020	Passante a rullo mm 20 Rolling loop fitting mm 20	•	•	•	50
426 NT 025	Passante a rullo mm 25 Rolling loop fitting mm 25	•	•	•	50
426 NT 030	Passante a rullo mm 30 Rolling loop fitting mm 30	•	•	•	50





722 TP 006-LV



722 TP 006-OC/LV



722 TP 006-OSC



722 TP R37-LV



722 TP 007-OSC



722 TP 722-BS



722 TP Q08-OSC



722 TP-LV



722 TP-OC



722 TP-OSC



		LV	BG	OC	OSC	OC/LV	BS	GREZZO	
PULSANTE CAMPANELLO CON ROSETTA / BELL PUSH ON ROSE									
722 TP 006	Pulsante campanello con rosetta 006 Ø50x8 Bell push on rose 006 Ø50x8	•		•		•			6
722 TP 007	Pulsante campanello con rosetta 007 mm 67x27 Bell push on rose 007 mm 67x27	•		•					6
722 TP R37	Pulsante campanello con rosetta R37 mm 41x74 Bell push on rose R37 mm 41x74	•							6
722 TP 722	Pulsante campanello con rosetta 722 mm 40x80 Bell push on rose 722 mm 40x80						•		6
722 TP Q08	Pulsante campanello con rosetta Q08 mm 50x50 Bell push on rose Q08 mm 50x50	•		•					6
722 TP	Solo pulsante campanello norme CE 12V Bell push button CE norm 12V - only	•		•				•	12

* SOLO LV



Extra per confezione self-service in blister
Extra for self-service blister packing

€ 1,07

Su richiesta personalizzazione **targhette porta nome**
con incisione laser

On request **name plates** with custom laser engraving



Esempi di personalizzazione
Customization examples



- Extra prezzo per minimo 36 pezzi: Euro 1,00 *cad.

* salvo verifica fattibilità logo richiesto

* per quantità inferiori extra prezzo da concordare

- Extra price for minimum quantity of 36 pcs: Euro 1,00 *each piece

*subject to feasibility of requested logo

*extra price for smaller quantities: to be agreed



art. 327 TP

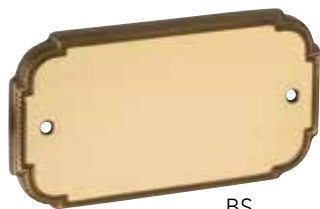

BS

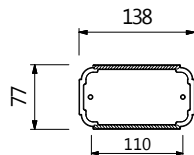

VERSIONI / VERSIONS



Finiture
Finishes

LV
BS



TARGHETTA / NAME PLATE

€

327 TP 000

Targhetta portanome neutra
Name plate

•

12

art. 437 TP



SNV

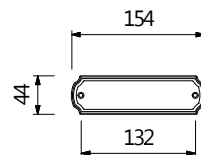

VERSIONI / VERSIONS



Finiture
Finishes

LV

OSC

SNV



TARGHETTA / NAME PLATE

€

437 TP 000

Targhetta portanome neutra
Name plate

•

•

•

12

art. 446 TP



OSC

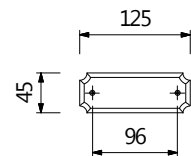

VERSIONI / VERSIONS



Finiture
Finishes

LV

OSC

SNV



TARGHETTA / NAME PLATE

€

446 TP 000

Targhetta portanome neutra
Name plate

•

•

•

12

art. 447 TP



LV

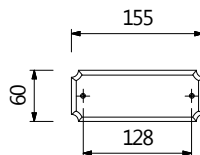

VERSIONI / VERSIONS



Finiture
Finishes

LV

OSC

SNV



TARGHETTA / NAME PLATE

€

447 TP 000

Targhetta portanome neutra
Name plate

•

•

•

12

art. 646 TP



OSC

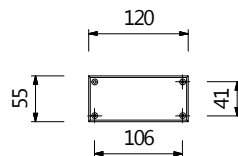

VERSIONI / VERSIONS



Finiture
Finishes

LV

OC
OSC

SNV



TARGHETTA / NAME PLATE

€

646 TP 000

Targhetta portanome neutra
Name plate

•

•

•

12

art. 647 TP



LV

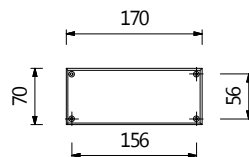

VERSIONI / VERSIONS



Finiture
Finishes

LV

OC
OSC

SNV



TARGHETTA / NAME PLATE

€

€

€

647 TP 000

Targhetta portanome neutra
Name plate

•

•

•

12

art. 720 TP



LV

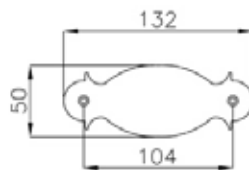

VERSIONI / VERSIONS



Finiture
Finishes

LV
BG



TARGHETTA / NAME PLATE

€

720 TP 000

Targhetta portanome neutra
Name plate

•

12

art. 721 TP



BS

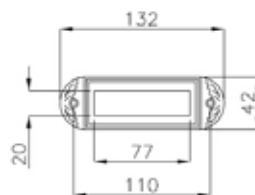

VERSIONI / VERSIONS



Finiture
Finishes

BS



TARGHETTA / NAME PLATE

€

721 TP ***

Targhetta portanome neutra con finestra 77 x 20
Name plate with window 77 x 20

•

12

art. 723 TP



LV

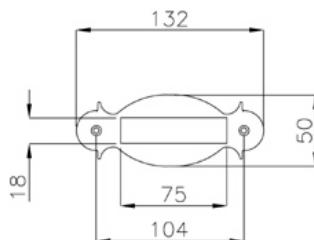

VERSIONI / VERSIONS



Finiture
Finishes

LV
BG



TARGHETTA / NAME PLATE

€

723 TP ***

Targhetta portanome neutra con finestra 75 x 18
Name plate with window 75 x 18

•

12

art. 725 TP

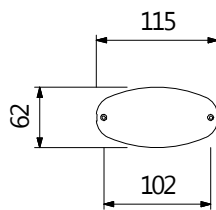

VERSIONI / VERSIONS



Finiture
Finishes

LV
BF



TARGHETTA / NAME PLATE

€

725 TP 000

Targhetta portanome neutra
Name plate

12

art. 726 TP

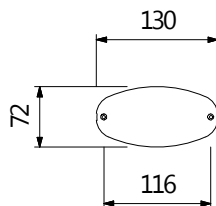

VERSIONI / VERSIONS



Finiture
Finishes

LV

OC
OSC



TARGHETTA / NAME PLATE

€

€

726 TP 000

Targhetta portanome neutra
Name plate

12

art. 747 TP

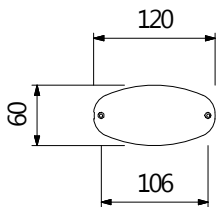

VERSIONI / VERSIONS



Finiture
Finishes

LV

OC
OSC

SNV



TARGHETTA / NAME PLATE

€

€

€

747 TP 000

Targhetta portanome neutra
Name plate

12

art. 757 TP



OSC

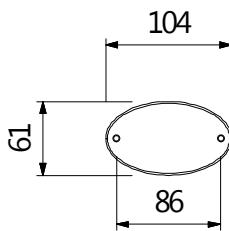

VERSIONI / VERSIONS



Finiture
Finishes

LV

OC
OSC

SNV



TARGHETTA / NAME PLATE

757 TP 000

Targhetta portanome neutra
Name plate

€

€

€

12

art. 728 TP



LV



OSC

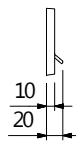
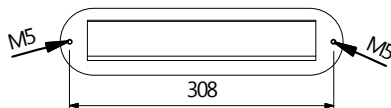
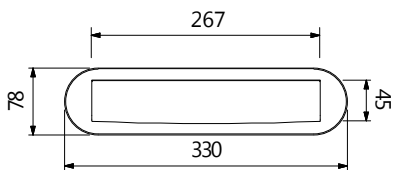

VERSIONI / VERSIONS



Finiture
Finishes

LV
BG

OC
OSC

LR



BUCALETTERE / LETTER PLATE

728 TP ***

Placca bucalettere con luce passaggio mm 267x38
Letter Plate with passage space mm 267x38

€

€

€

1

art.

Q30

Q-SPY Spioncino quadro

Square door viewer

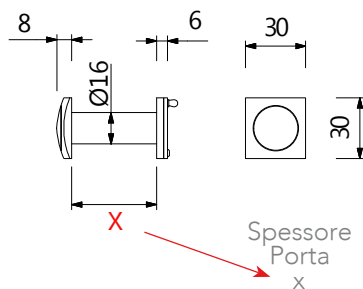
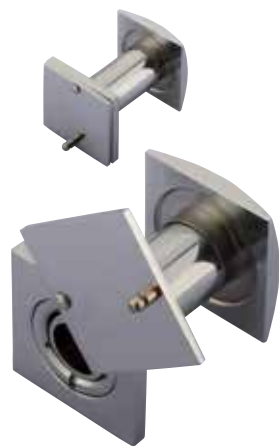

Senza Prolunga <i>Without extension</i>	34 - 60 mm
Con prolunga <i>With extension</i>	34 - 110 mm



VERSIONI / VERSIONS



Finiture
Finishes

LV
OC
OSC

SNV



SPIONCINO QUADRO / SQUARE DOOR VIEWER

		€	€	
Q30 TP ***	Spioncino Q-SPY <i>Q-SPY Viewer</i>	•	•	1
Q30 TP 00E	Spioncino Q-SPY con prolunga Q30B1 <i>Q-SPY Viewer with Q30B1 extension</i>	•	•	1
		€		
Q30 B1 ***	Prolunga da 60 a 110mm per spioncino Q30 <i>60 to 110 mm extension for Q30 door viewer</i>	•		1

art.620 GA



OC



OSC

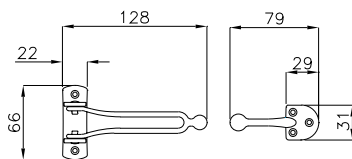

GANCIO ROMA / ROMA DOOR GUARD 620 GA



OL	OB	OC	OSC	
•	•	•	•	12



Extra per confezione self-service in blister
Extra for self-service blister packing

€ 1,21

art.647 GA

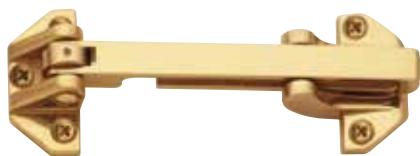

LV

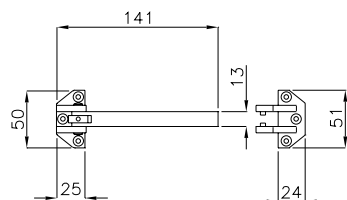

GANCIO PRIVACY/ DOOR GUARD 647 GA

Gancio privacy con molla a scatto
Security door guard with spring



LV	OC	
•	•	12



Extra per confezione self-service in blister
Extra for self-service blister packing

€ 1,21

art.648 GA



OTTONATO/BRASSED

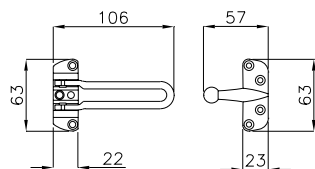

GANCIO PRIVACY/ DOOR GUARD 648 GA

Gancio privacy con molla a scatto
Security door guard with spring



OTTONATO	
•	12



Extra per confezione self-service in blister
Extra for self-service blister packing

€ 1,21

art.633 CN

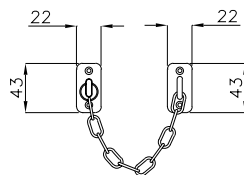

CATENELLA LEGGERA / LIGHT SMALL CHAIN

633 CN

Catenella mm 150
Small chain mm 150



OL	OC	
•	•	25



Extra per confezione self-service in blister
Extra for self-service blister packing

€ 1,21

art.634 CN

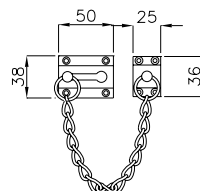

CATENELLA PESANTE/ HEAVY SMALL CHAIN

634 CN

Catenella mm 220
Small chain mm 220



OL	OB	
•	•	24



Extra per confezione self-service in blister
Extra for self-service blister packing

€ 1,21

art.636 CN

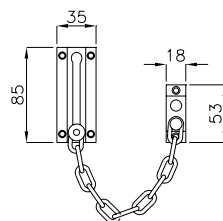
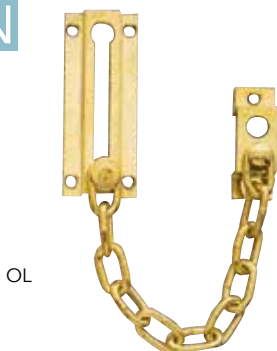

CATENELLA / SMALL CHAIN

636 CN

Catenella mm 180
Small chain mm 180



OL	BG	OC	
•	•	•	24



Extra per confezione self-service in blister
Extra for self-service blister packing

€ 1,21

art. 195 FE

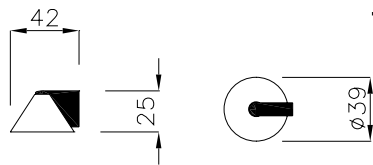

OTTONATO/BRASSED

CROMATO/CHROME

FERMAPORTE / DOOR STOP

195 FE

Fermaporte a pavimento
Door stop - floor mounted type

	OTTONATO	CROMATO	
	•	•	25



Extra per confezione self-service in blister
Extra for self-service blister packing

€ 1,07

art. 197 FE

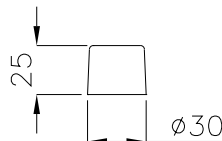

FERMAPORTE / DOOR STOP

197 FE

Fermaporte a pavimento
Door stop - floor mounted type

	NR	
	•	25



Extra per confezione self-service in blister
Extra for self-service blister packing

€ 1,07

art. 198 FE



NR/LV

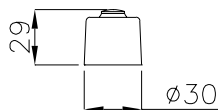

FERMAPORTE / DOOR STOP

198 FE

Fermaporte A PAVIMENTO in gomma/ottone
Door stop in rubber/brass - floor mounted type

	NR/LV	NR/OC	
	•	•	25



Extra per confezione self-service in blister
Extra for self-service blister packing

€ 1,07

art. 199 FE



LV



OC

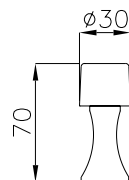

FERMAPORTE / DOOR STOP

199 FE

Fermaporte A MURO
Door stop - wall mounted type

	LV	OC OSC	OB	
	•	•	•	10



Extra per confezione self-service in blister
Extra for self-service blister packing

€ 1,07

art. 200 FE



LV



OC

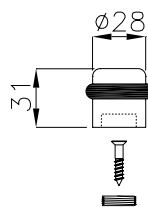

FERMAPORTE TIP / TIP DOOR STOP

200 FE

Fermaporte A PAVIMENTO
Door stop - floor mounted type



LV	OC OSC	OB	
•	•	•	10



Extra per confezione self-service in blister
Extra for self-service blister packing

€ 1,07

art. 202 FE

TIPO ALTO / HIGH TYPE



LV



OC

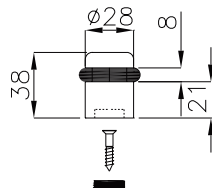

FERMAPORTE TAP / TAP DOOR STOP

202 FE

Fermaporte A PAVIMENTO
Door stop - floor mounted type



LV	OC OSC	OB	
•	•	•	10



Extra per confezione self-service in blister
Extra for self-service blister packing

€ 1,07

art. 606 FE



LV



OC



BN



NR

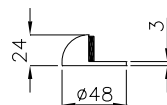

FERMAPORTE A PAVIMENTO DIXI TIPO BASSO / DIXI DOOR STOP MODEL LOW

606 FE

Fermaporte a pavimento
Door stop - floor mounted type



LV	OC OSC	BN NR	OB	
•	•	•	•	25



Extra per confezione self-service in blister
Extra for self-service blister packing

€ 1,07

art. 607 FE



LV



OSC

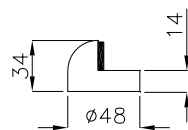

FERMAPORTE A PAVIMENTO - TIPO ALTO / DOOR STOP MODEL HIGH

607 FE

Fermaporte a pavimento
Door stop - floor mounted type



LV	OC OSC	BN NR	OB	
•	•	•	•	2



Extra per confezione self-service in blister
Extra for self-service blister packing

€ 1,07

art. 670 FE



670 FE 055-LV

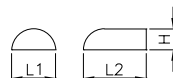

	L1	L2	H
670 FE 055	40	57	19

FERMAPORTONE A MURARE / MAIN DOOR STOP FOR CEMENTING

670 FE 055

Fermaportone mm 57x40x19
Main door-stop mm 57x40x19



LV	LR	
•	•	12

art. 205 FE

Fermaporte magnetico
Magnetic Doorstop

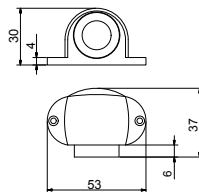

VERSIONI / VERSIONS



Finiture
Finishes

INOX SAT



FERMAPORTE / DOORSTOP

205 FE ***

Fermaporte a calamita
Magnetic door stop

€

•

10

art. 592 FE - 593 FE EASY

Fermapersiane
con aggancio automatico



Regolabilità:



da 12 mm a 38 mm



da 39 mm a 56 mm



FERMAPERSIANE CON AGGANCIO AUTOMATICO / STOP SHUTTER WITH SNAP HOOK		NR	
592 FE*	Fermapersiane con aggancio automatico Stop shutter with snap hook	2,88	24
593 FE*	Fermapersiane con aggancio automatico Stop shutter with snap hook	2,28	150

*Ogni confezione contiene accessori ed istruzioni per il montaggio

*Confezione industriale senza istruzioni per il montaggio - senza vite - c/foro per vite Ø 7

Questo nuovo fermapersiane é composto da un unico pezzo ed è fornito con differenti spessori in gomma, che lo rendono adatto ad imposte, finestre o porte con spessori variabili da 12 a 38 mm, o da 39 a 56 mm a richiesta

Si tratta di un articolo in tecnopolimero flessibile, che essendo privo di meccanismi in metallo, ha il pregio di non essere soggetto ai danni degli agenti atmosferici, quali raggi ultravioletti, umidità, sale marino ed inquinamento urbano.

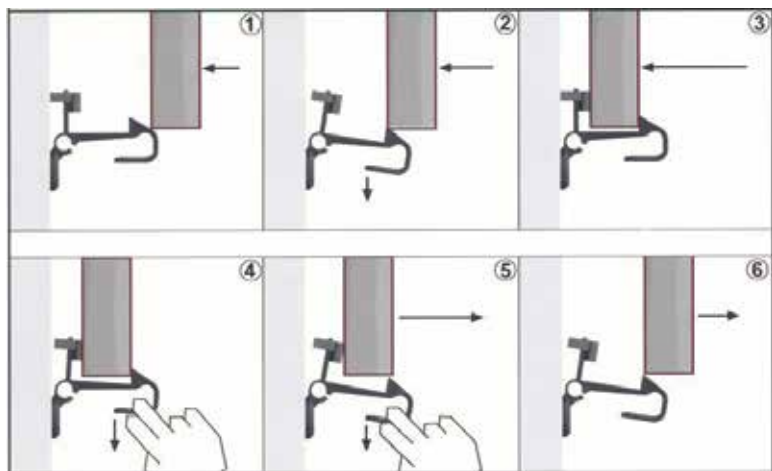

ADATTO ANCHE PER PORTE-FINESTRE

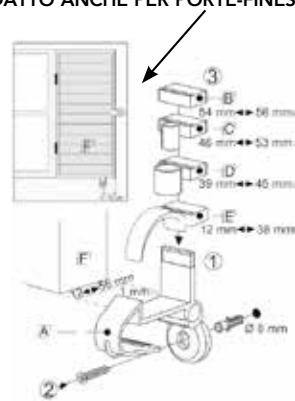

art. 594 FE

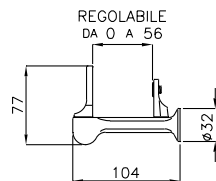
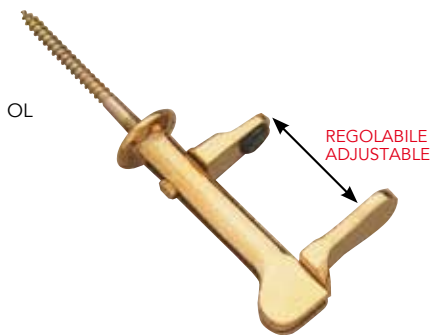

FERMAPERSIANE IN OTTONE CON FERMO / STOP SHUTTER IN BRASS WITH BLOCK

594 FE

Fermapersiane liscio con fermo regolabile
Smooth stop shutter with adjustable block

OL	OB	
•	•	12



Extra per confezione self-service in blister
Extra for self-service blister packing

€ 1,21

art. 595 FE

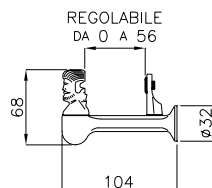
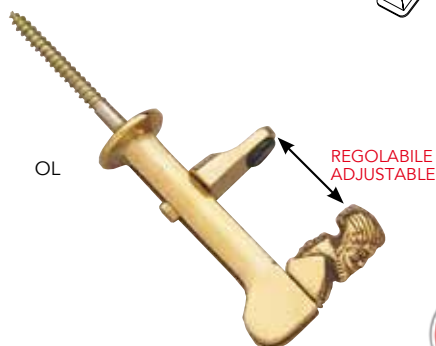

FERMAPERSIANE IN OTTONE CON FERMO / STOP SHUTTER IN BRASS WITH BLOCK

595 FE

Fermapersiane con ometto - con fermo regolabile
Stop shutter with a small man with adjustable block

OL	OB	
•	•	12



Extra per confezione self-service in blister
Extra for self-service blister packing

€ 1,21

art. 596 FE

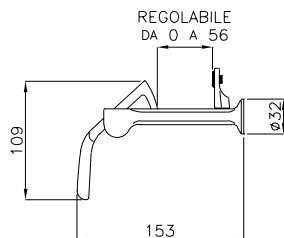
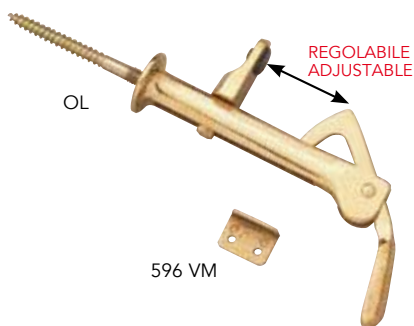

FERMAPERSIANE IN OTTONE CON FERMO / STOP SHUTTER IN BRASS WITH BLOCK

596 FE

Fermapersiane a pendolo - con fermo regolabile e con piastrina paracolpi
Stop shutter with pendulum, adjustable block and buffer small plate

OL	OB	
•	•	12

596 VM

Piastrina paracolpi in ottone mm 9x18x26
Small plate buffer in brass mm 9x18x26

•	•	50
---	---	----



Extra per confezione self-service in blister
Extra for self-service blister packing

€ 2,41

art. 598 FE



OL

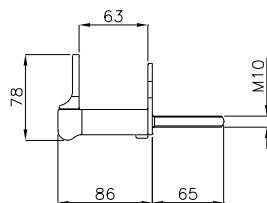

FERMAPERSIANE IN OTTONE CON FERMO / STOP SHUTTER IN BRASS WITH BLOCK

598 FE

Fermapersiane liscio con fermo
Smooth stop shutter with block

OL	OB	
•	•	12

art. 600 FE



OB

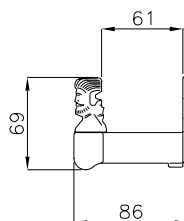

FERMAPERSIANE IN OTTONE CON FERMO / STOP SHUTTER IN BRASS WITH BLOCK

600 FE

Fermapersiane con ometto e con fermo
Stop shutter with a small man and with block

OL	OB	
•	•	12



Extra per confezione self-service in blister
Extra for self-service blister packing

€ 1,21

art. 601 FE

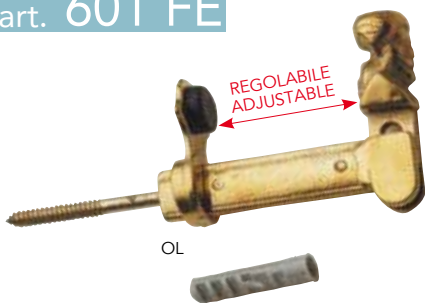

OL

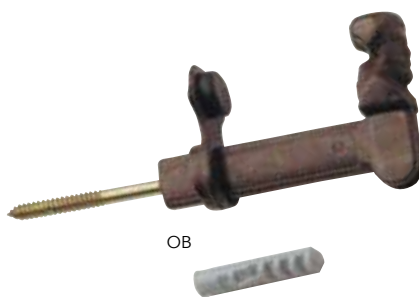

OB

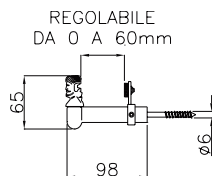

FERMAPERSIANE IN OTTONE CON FERMO / STOP SHUTTER IN BRASS WITH BLOCK

601 FE

Fermapersiane con ometto e con fermo regolabile
Stop shutter with a small man with adjustable block

OL	OB	
•	•	12

art. 603 FE



OL



OB

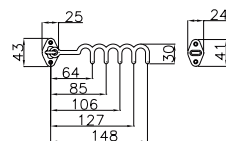

FERMAPERSIANE A PETTINE / COMB STOP SHUTTER

603 FE 00P

Fermapersiane a pettine a 5 posizioni con incontro
Comb stop shutter with 5 positions with striker

603 IN

Incontro per 603 FE
Striker for 603 FE



	OL	OB	OC	
603 FE 00P	•	•	•	25
603 IN	•	•	•	50

art. 603 FE

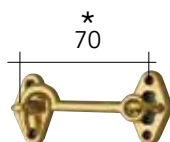

603 FE 060-OL

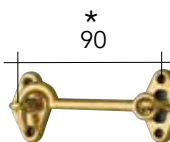

603 FE 080-OL

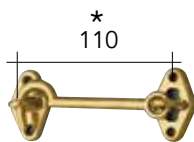

603 FE 100-OL

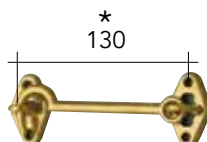

603 FE 120-OL

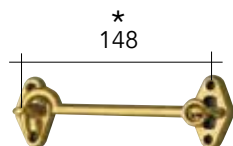
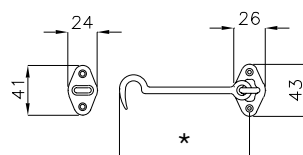

603 FE 140-OL

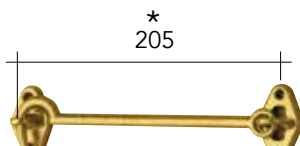

603 FE 200-OL



603 FE 250-OL

FERMAPERSIANE SEMPLICE / STOP SHUTTER

603 FE 060

Fermapersiane da 60
Stop shutter mm 60

603 FE 080

Fermapersiane da 80
Stop shutter mm 80

603 FE 100

Fermapersiane da 100
Stop shutter mm 100

603 FE 120

Fermapersiane da 120
Stop shutter mm 120

603 FE 140

Fermapersiane da 140
Stop shutter mm 140

603 FE 200

Fermapersiane da 200
Stop shutter mm 200

603 FE 250

Fermapersiane da 250
Stop shutter mm 250



	OL	OB	OC	
603 FE 060	•	•	•	25
603 FE 080	•	•	•	25
603 FE 100	•	•	•	25
603 FE 120	•	•	•	25
603 FE 140	•	•	•	25
603 FE 200	•	•	•	12
603 FE 250	•	•	•	12

art. 602 FE

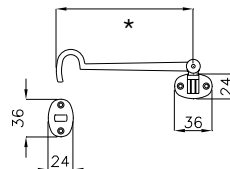
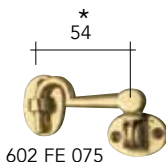
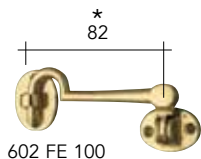
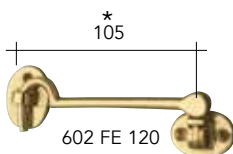
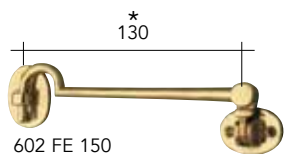

FERMAPERSIANE SNODATO / STOP SHUTTER

		LV	
602 FE 075	Fermapersiane da 75 Stop shutter mm 75	•	25
602 FE 100	Fermapersiane da 100 Stop shutter mm 100	•	25
602 FE 120	Fermapersiane da 120 Stop shutter mm 120	•	25
602 FE 150	Fermapersiane da 150 Stop shutter mm 150	•	25



Extra per confezione self-service in blister
Extra for self-service blister packing € 1,21

art. 604 NZ

604 IN 00A-OL



604 IN 00B-OL



604 NZ-OL



604 NZ-OC

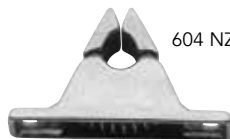

604 NZ-NR



604 NZ-OSC

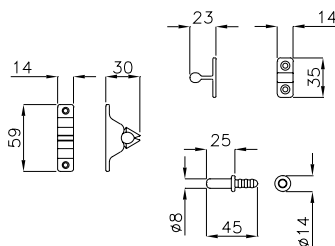

PINZE FERMAPORTE / BRASS BALL CATCHES

		OL	OB	OC	OSC	NR	
604 NZ	Pinze fermaporte senza incontro Ball catch without striker	•	•	•	•	•	50
604 IN 00A	Incontro di tipo "A" a piolo per art. 604 NZ Striker "A" - pin type	•	•	•	•	•	50
604 IN 00B	Incontro di tipo "B" a vite per art. 604 NZ Striker "B" - screw type	•	•	•	•	•	50



Extra per confezione self-service in blister
Extra for self-service blister packing € 1,07

art. 661 NZ

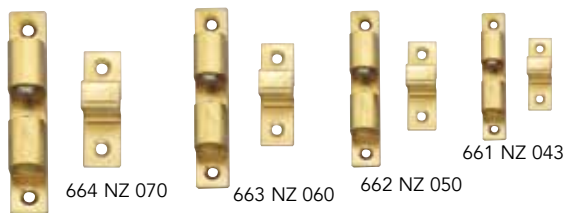

	L1	L2	L3	L4
661 NZ 043	43	10	24	10
662 NZ 050	50	10	30	10
663 NZ 060	60	12	45	12
664 NZ 070	70	12	50	12

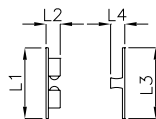

OL



PINZE A SCATTO CON SFERE / BRASS BALL CATCHES

661 NZ 043	Pinza a scatto con sfere mm 43 con incontro mm,25 Brass ball catches mm 43 with striker mm 25	•	50
662 NZ 050	Pinza a scatto con sfere mm 50 con incontro mm 28 Brass ball catches mm 50 with striker mm 28	•	50
663 NZ 060	Pinza a scatto con sfere mm 60 con incontro mm 35 Brass ball catches mm 60 with striker mm 35	•	25
664 NZ 070	Pinza a scatto con sfere mm 70 con incontro mm 40 Brass ball catches mm 70 with striker mm 40	•	25



Extra per confezione self-service in blister da **2 pz.**
Extra for self-service blister packing **2 pcs.**

art. 616 NZ - EVE



616 NZ

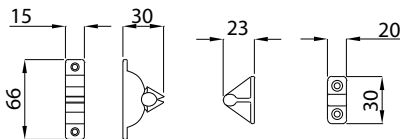

NR



PINZE FERMAPORTE CON INCONTRO / BALL CATCHES WITH STRIKER

616 NZ	Pinze fermaporte in TECNOPOLIMERO nero con incontro - viti e tasselli Ball catch	•	50
--------	---	---	----

Pinza **EVE**

Economica e **Versatile**

Funziona sia a muro che a pavimento fino ad una inclinazione massima di 20° per lato tra incontro e corpo pinza

PESO DI SGANCIO 6,5 KG
WEIGHT OF RELEASE 6,5 KGS

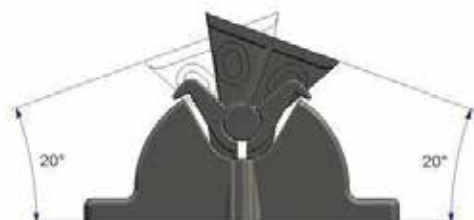



605 NZ-OL



605 NZ-OC

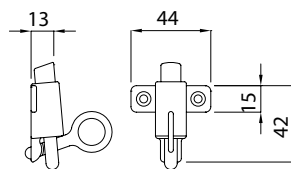

605 NZ-AGV



605 NZ-AN



605 NZ-NR

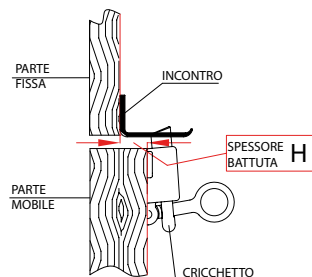

605 IN 00B-OL

INCONTRO TIPO "A"
Altezze spessore H
non standard a richiesta*
(da 10 a 30 mm)

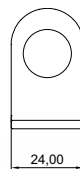
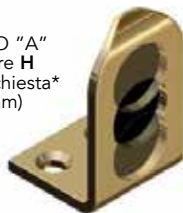

	H
605 IN 10A	10
605 IN 15A	15
605 IN 20A	20
605 IN 25A	25
605 IN 30A	30



605 IN 10A-OL



605 IN 15A-OL



605 IN 20A-OL



605 IN 25A-OL



605 IN 30A-OL



CRICCHETTI SOPRALUCE / OVERLIGHT POWL MM 65X45

		OL	OB	OC	OSC	AGV	NR AN	
605 NZ	Cricchetti senza incontro Overlight powl without striker	•	•	•	•	•	•	50
605 IN 10A	Incontro tipo "A" ad angolo per battuta spessore mm 10 Angle Striker for thickness mm 10	•	•	•	•	•	•	50
605 IN 15A	Incontro tipo "A" ad angolo per battuta spessore mm 15 Angle Striker for thickness mm 15	•	•	•	•	•	•	50
605 IN 20A	Incontro tipo "A" ad angolo per battuta spessore mm 20 Angle Striker for thickness mm 20	•	•	•	•	•	•	50
605 IN 25A	Incontro tipo "A" ad angolo per battuta spessore mm 25 Angle Striker for thickness mm 25	•	•	•	•	•	•	50
605 IN 30A	Incontro tipo "A" ad angolo per battuta spessore mm 30 Angle Striker for thickness mm 30	•	•	•	•	•	•	50
605 IN 00B	Incontro tipo "B" normale a filo per art. 605 NZ Striker "B" - normal type	•	•	•	•	•	•	50

*Extra per incontro tipo "A" ad angolo per battute non standard a richiesta da 10 a 30 mm (12-18-22-28 mm)

€ 0,30



614 NZ-LV

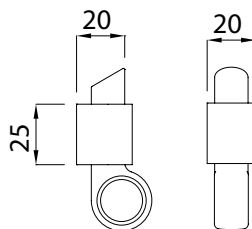

614 NZ-BG

Esempi di applicazione:



614 NZ-AN



614 NZ + 614 IN ANGOLO



614 NZ-OSC



614 NZ + 614 IN REGOLABILE



614 NZ-AGV



614 NZ-OC



614 NZ + 614 IN A FILO



614 IN 00R-LV

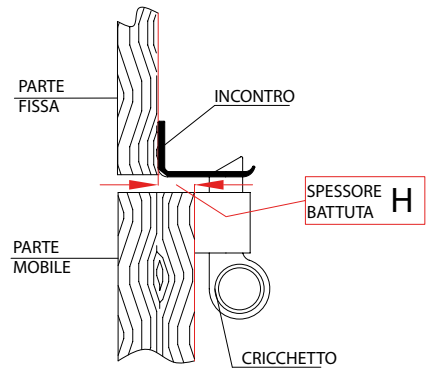
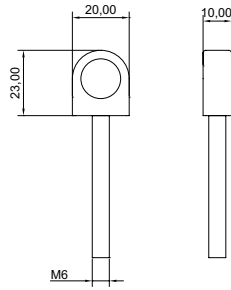

614 IN 00B-LV



INCONTRO TIPO "A"
Altezze spessore H
non standard a richiesta*
(da 0 a 25 mm)

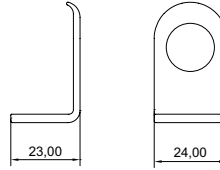

	H
614 IN 000	0
614 IN 10A	10
614 IN 15A	15
614 IN 20A	20
614 IN 25A	25



614 IN 00A-LV



614 IN 10A-LV



614 IN 15A-LV



614 IN 20A-LV



614 IN 25A-LV



CRICCHETTO SOPRA LUCE SKY / OVERLIGHT POWL SKY

		LV BG	OC OSC	OL VBN	AN	AGV	
614 NZ	Cricchetto coprivite mm 20 - senza incontro Cover screw powl mm20 - without striker	•	•	•	•	•	12
614 IN 000	Incontro tipo "A" ad angolo per battuta spessore mm 00 a filo Angle Striker for thickness mm 00	•	•	•	•	•	12
614 IN 10A	Incontro tipo "A" ad angolo per battuta spessore mm 10 Angle Striker for thickness mm 10	•	•	•	•	•	12
614 IN 15A	Incontro tipo "A" ad angolo per battuta spessore mm 15 Angle Striker for thickness mm 15	•	•	•	•	•	12
614 IN 20A	Incontro tipo "A" ad angolo per battuta spessore mm 20 Angle Striker for thickness mm 20	•	•	•	•	•	12
614 IN 25A	Incontro tipo "A" ad angolo per battuta spessore mm 25 Angle Striker for thickness mm 25	•	•	•	•	•	12
614 IN 00R	Incontro tipo "R" regolabile Adjustable Striker	•	•	•	•	•	12
614 IN 00B	Incontro tipo "B" normale a filo per art. 614 NZ Striker "B" - normal type	•	•	•	•	•	12

*Extra per incontro tipo "A" ad angolo per battute non standard a richiesta da 0 a 25 mm (5-7-12-18-22 mm) € 0,30

art. 639 TV TAVELLINO A SCATTO



639 TV-OL

639 IN-OL



639 TV-AN

639 IN-AN



639 TV-OC

639 IN-OC



639 TV-AGV

639 IN-AGV



639 TV-OB

639 IN-OB



639 TV-RX

639 IN-RX

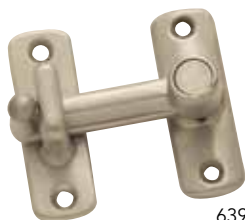

639 TV-Cromo opaco

639 IN-Cromo opaco

	L	H
639 IN 005	10	0
639 IN 010	14,5	4,5
639 IN 015	17,5	7,5
639 IN 020	22,5	12,5
639 IN 022	24	14
639 IN 025	27,5	17,5
639 IN 030	32	22

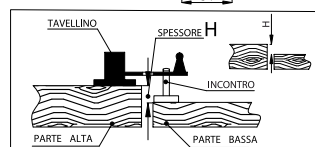
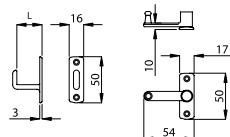

TAVELLINO A SCATTO LISCIO / SMOOTH RELEASE HOLLOW TILE

639 TV	OL	OB	OC	Cromo opaco	AN BGO	AGV	RX	
Tavellino senza incontro Hollow tile without striker	•	•	•	•	•	•	•	50
639 IN 005 Incontro per tavellino mm 5 - A FILO Striker mm 5	•	•	•	•	•	•	•	50
639 IN 010 Incontro per tavellino mm 10 Striker mm 10	•	•	•	•	•	•	•	50
639 IN 015 Incontro per tavellino mm 15 Striker mm 15	•	•	•	•	•	•	•	50
639 IN 020 Incontro per tavellino mm 20 Striker mm 20	•	•	•	•	•	•	•	50
639 IN 022 Incontro per tavellino mm 22 Striker mm 22	•	•	•	•	•	•	•	50
639 IN 025 Incontro per tavellino mm 25 Striker mm 25	•	•	•	•	•	•	•	50
639 IN 030 Incontro per tavellino mm 30 Striker mm 30	•	•	•	•	•	•	•	50

art. 631 TV

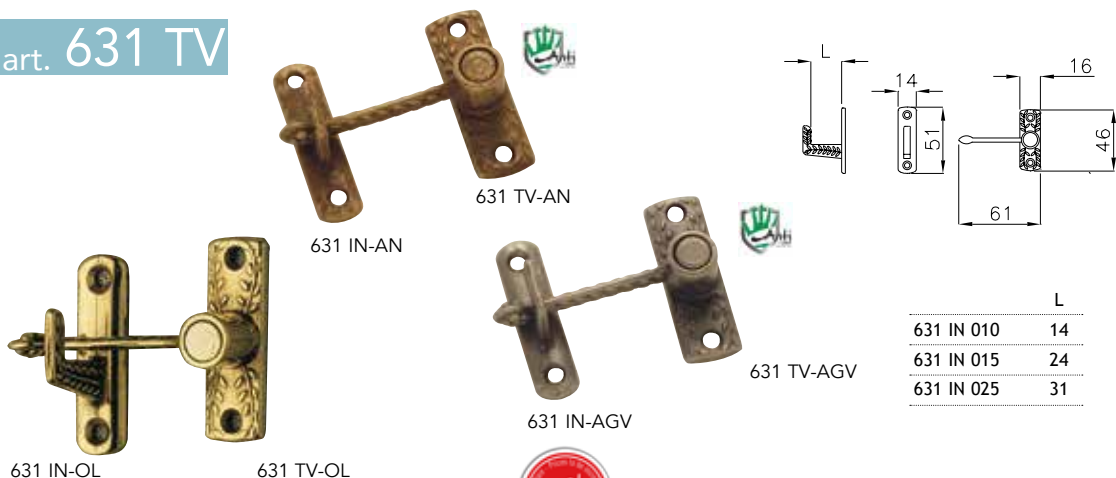

	L
631 IN 010	14
631 IN 015	24
631 IN 025	31



TAVELLINO A SCATTO BAROCCO / BAROCCO RELEASE HOLLOW TILE

		OL	OB	OC	AN	AGV	
631 TV	Tavellino senza incontro Hollow tile without striker	•	•	•	•	•	50
631 IN 010	Incontro per tavellino da 10 Striker mm 10	•	•	•	•	•	50
631 IN 015	Incontro per tavellino da 15 Striker mm 15	•	•	•	•	•	50
631 IN 025	Incontro per tavellino da 25 Striker mm 25	•	•	•	•	•	50



Extra per confezione self-service in blister
Extra for self-service blister packing

€ 1,07

art. 632 TV

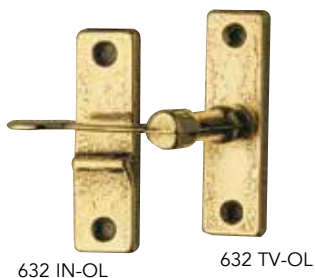

	L
632 TV 015	15
632 TV 020	20
632 TV 025	25

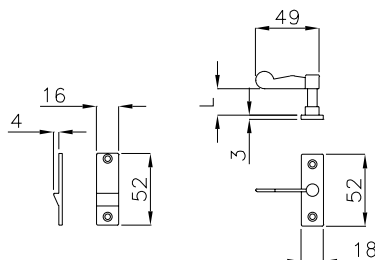

TAVELLINO NORMALE CON INCONTRO A FILO / NORMAL HOLLOW TILE WITH STRAIGHT STRIKER

		OL	OB	OC	
632 TV 015	Tavellino mm 15 - senza incontro Hollow tile mm 15 - without striker	•	•	•	50
632 TV 020	Tavellino mm 20 - senza incontro Hollow tile mm 20 - without striker	•	•	•	50
632 TV 025	Tavellino mm 25 - senza incontro Hollow tile mm 25 - without striker	•	•	•	50
632 IN	Incontro a filo per tavellino art. 632 Straight striker for hollow tile art. 632	•	•	•	50



Extra per confezione self-service in blister
Extra for self-service blister packing

€ 1,07

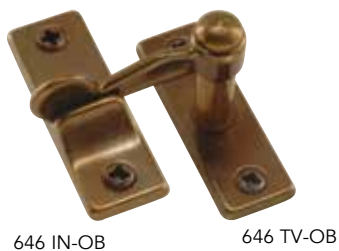
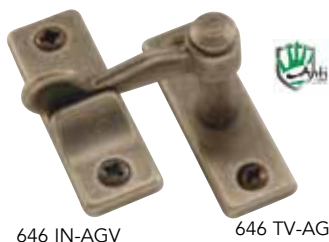
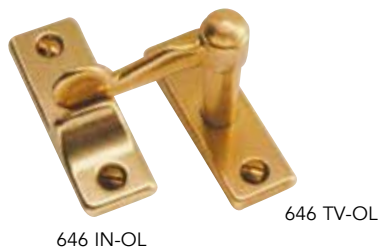

art. 646 TV TAVELLINO "ELEGANT"

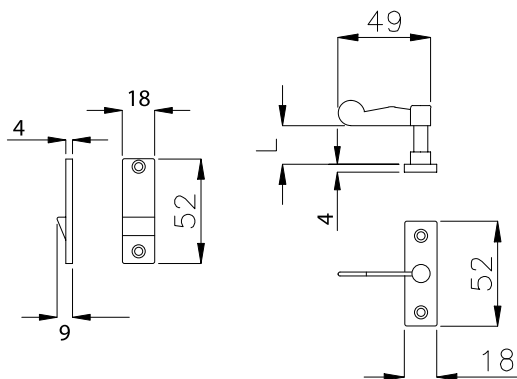

	L	H
646 TV 000	0	0
646 TV 010	10	10
646 TV 015	15	15
646 TV 018	18	18
646 TV 020	20	20
646 TV 022	22	22
646 TV 025	25	25
646 TV 030	30	30

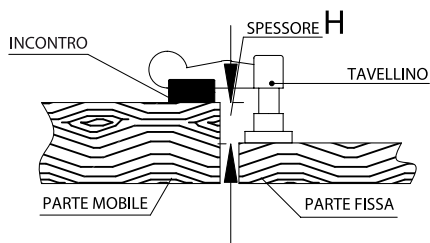

TAVELLINO ELEGANT ALLA ROMANA CON INCONTRO A FILO / NORMAL HOLLOW TILE WITH STRAIGHT STRIKER

	OL	OB	NR	OC	BGO AN	Cromo opaco RX	AGV	
646 TV 000	•	•	•	•	•	•	•	25
646 TV 010	•	•	•	•	•	•	•	25
646 TV 015	•	•	•	•	•	•	•	25
646 TV 018	•	•	•	•	•	•	•	25
646 TV 020	•	•	•	•	•	•	•	25
646 TV 022	•	•	•	•	•	•	•	25
646 TV 025	•	•	•	•	•	•	•	25
646 TV 030	•	•	•	•	•	•	•	25
646 IN	•	•	•	•	•	•	•	25

art. 639 IN

INCONTRO SPECIALE PER PROFILI STRETTI



	L	H
639 IN S05	10	0
639 IN S10	14,5	4,5
639 IN S15	17,5	7,5
639 IN S20	22,5	12,5
639 IN S22	24	14
639 IN S25	27,5	17,5
639 IN S30	32	22

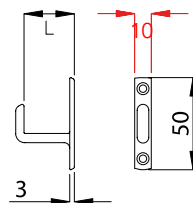

SOLO INCONTRO TIPO S PER ART.639 CON BASE STRETTA MM 10 / ONLY STRIKER S TYPE FOR ART. 639			OL	
639 IN S05	Incontro per tavellino mm 5 Striker mm 5		•	50
639 IN S10	Incontro per tavellino mm 10 Striker mm 10		•	50
639 IN S15	Incontro per tavellino mm 15 Striker mm 15		•	50
639 IN S20	Incontro per tavellino mm 20 Striker mm 20		•	50
639 IN S22	Incontro per tavellino mm 22 Striker mm 22		•	50
639 IN S25	Incontro per tavellino mm 25 Striker mm 25		•	50
639 IN S30	Incontro per tavellino mm 30 Striker mm 30		•	50



Extra per confezione self-service in blister
Extra for self-service blister packing € 1,07

art. 71 CT



LV

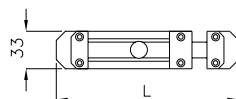

	L
71 CT 150	150
71 CT 200	200

CATENACCI ORIZZONTALI / HORIZONTAL BOLTS			BG	LV	OC	
71 CT 150	Catenacci mm 150 Bolt mm 150		•	•	•	12
71 CT 200	Catenacci mm 200 Bolt mm 200		•	•	•	6



Extra per confezione self-service in blister
Extra for self-service blister packing € 2,14

	L1	L2
72 CT 150	120	30
72 CT 200	150	50
72 CT 250	190	60
72 CT 300	220	80
72 CT 400	260	140

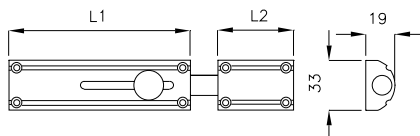

LV

CATENACCI ORIZZONTALI / HORIZONTAL BOLTS

		CORSOIO mm	LV OB	OC OSC	
72 CT 150	Catenaccio orizzontale tondo mm 150 Horizontal round bolt mm 150	Ø 13	•	•	6
72 CT 200	Catenaccio orizzontale tondo mm 200 Horizontal round bolt mm 200	Ø 13	•	•	6
72 CT 250	Catenaccio orizzontale tondo mm 250 Horizontal round bolt mm 250	Ø 13	•	•	6
72 CT 300	Catenaccio orizzontale tondo mm 300 Horizontal round bolt mm 300	Ø 13	•	•	6
72 CT 400	Catenaccio orizzontale tondo mm 400 Horizontal round bolt mm 400	Ø 13	•	•	6



Extra per confezione self-service in blister (possibile per misure da: 150-200-250-300)
Extra for self-service blister packing (available only for measures: 150-200-250-300)

€ 2,95



	L
73 CT 200	200
73 CT 250	250
73 CT 300	300
73 CT 400	400
73 CT 500	500
73 CT 600	600

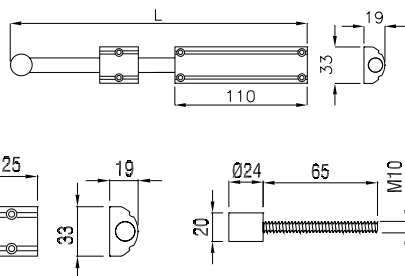

73 IN 00S



73 IN 00N



CATENACCI VERTICALI / VERTICAL BOLTS

		CORSOIO mm	LV OB	OSC OC	
73 CT 200	Catenaccio verticale tondo senza incontro mm 200 Vertical round bolt without striker mm 200	Ø 13	•	•	6
73 CT 250	Catenaccio verticale tondo senza incontro mm 250 Vertical round bolt without striker mm 250	Ø 13	•	•	6
73 CT 300	Catenaccio verticale tondo senza incontro mm 300 Vertical round bolt without striker mm 300	Ø 13	•	•	6
73 CT 400	Catenaccio verticale tondo senza incontro mm 400 Vertical round bolt without striker mm 400	Ø 13	•	•	6
73 CT 500	Catenaccio verticale tondo senza incontro mm 500 Vertical round bolt without striker mm 500	Ø 13	•	•	6
73 CT 600	Catenaccio verticale tondo senza incontro mm 600 Vertical round bolt without striker mm 600	Ø 13	•	•	6
73 IN 00N	Incontro per art. 73 mod. ANUBA ANUBA striker for art. 73	Ø 13	•	•	6
73 IN 00S	Incontro per art. 73 mod. NORMALE NORMAL striker for art. 73	Ø 13	•	•	6



Extra per confezione self-service in blister (possibile per misure da: 200-250-300)
Extra for self-service blister packing (available only for measures: 200-250-300)

€ 2,95

art. 74 CT - 75 CT

COPRIVITE STRETTO SOLO mm 20
NO VISIBLE SCREWS ONLY 20 mm WIDTH



74 CT-OSC

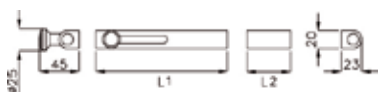

	L1	L2
74 CT 100	75	25
74 CT 150	120	30
74 CT 200	160	40
74 CT 250	200	50
74 CT 300	220	80



75 IN 00S



75 IN 00C



75 IN 00D



73 IN 00N

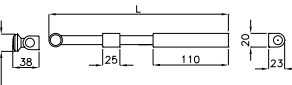
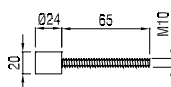

art.	L
75 CT 200	200
75 CT 250	250
75 CT 300	300
75 CT 400	400
75 CT 500	500

75 CT-LV

CATENACCI ORIZZONTALI / HORIZONTAL BOLTS

Art.	Description	CORSOIO mm	LV BG	OSC OC	Icon
74 CT 100	Catenaccio orizzontale tondo mm 100 Horizontal round bolt mm 100	Ø 13	•	•	12
74 CT 150	Catenaccio orizzontale tondo mm 150 Horizontal round bolt mm 150	Ø 13	•	•	12
74 CT 200	Catenaccio orizzontale tondo mm 200 Horizontal round bolt mm 200	Ø 13	•	•	12
74 CT 250	Catenaccio orizzontale tondo mm 250 Horizontal round bolt mm 250	Ø 13	•	•	12
74 CT 300	Catenaccio orizzontale tondo mm 300 Horizontal round bolt mm 300	Ø 13	•	•	12

CATENACCI VERTICALI / VERTICAL BOLTS

75 CT 200	Catenaccio verticale tondo senza incontro mm 200 Vertical round bolt without striker mm 200	Ø 13	•	•	12
75 CT 250	Catenaccio verticale tondo senza incontro mm 250 Vertical round bolt without striker mm 250	Ø 13	•	•	12
75 CT 300	Catenaccio verticale tondo senza incontro mm 300 Vertical round bolt without striker mm 300	Ø 13	•	•	12
75 CT 400	Catenaccio verticale tondo senza incontro mm 400 Vertical round bolt without striker mm 400	Ø 13	•	•	12
75 CT 500	Catenaccio verticale tondo senza incontro mm 500 Vertical round bolt without striker mm 500	Ø 13	•	•	12

INCONTRI / STRIKERS

Art.	Description	CORSOIO mm	LV OB	OSC OC	Icon
75 IN 00S	Incontro per art.75 mod. NORMALE mm 25x20x23 NORMAL striker for art.73 mm 25x20x23	Ø 13	•	•	12
75 IN 00C	Incontro per art.75 mod.C mm 50x20 Striker for art.75 type C mm 50x20	Ø 13	•	•	12
75 IN 00D	Incontro/Supporto per art.75 mod.D mm 70x20 per incontro ANUBA tipo N Striker/Base for art.75 type D mm 70x20 for ANUBA striker type N	Ø 13	•	•	12
73 IN 00N	Incontro per art.73/75 mod. ANUBA ANUBA striker for art.73/75	Ø 13	•	•	12

art. 211 CT - 212 CT - 213 CT - 214 CT - 215 CT



211 CT 040-OL



212 CT 050-OL



213 CT 065-OL



214 CT 075-OL



215 CT 100-OL

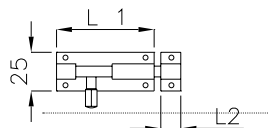

	L1	L2
211 CT 040	38	13
212 CT 050	54	13
213 CT 065	64	13
214 CT 075	77	16
215 CT 100	102	16

CATENACCIOLO / BOLT

		OL	OC	
211 CT 040	Catenacciolo base mm 40x25 incontro mm 13 Bolt mm 40x25 striker mm 13	•	•	36
212 CT 050	Catenacciolo base mm 50x25 incontro mm 13 Bolt mm 50x25 striker mm 13	•	•	36
213 CT 065	Catenacciolo base mm 65x25 incontro mm 13 Bolt mm 65x25 striker mm 13	•	•	36
214 CT 075	Catenacciolo base mm 75x25 incontro mm 16 Bolt mm 75x25 striker mm 16	•	•	36
215 CT 100	Catenacciolo base mm 100x25 incontro mm 16 Bolt mm 100x25 striker mm 16	•	•	36



Extra per confezione self-service in blister € 1,07
Extra for self-service blister packing

art. 63 CT



63 CT 003-LV



63 CT 006-OC



63 CT 007-LV

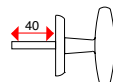

sporgenza ferro mm 40

CATENACCIO A CREMAGLIERA / RACK-BOLT

		LV BG	OC OSC	OL	
63 CT 003	Catenaccio a cremagliera con art.63 su rosetta 003 Ø45x7 - (P) 50 Rack-bolt with art.63 turn on rose 003 Ø45x7 - backset 50	•	•	•	6
63 CT 006	Catenaccio a cremagliera con art.63 su rosetta 006 Ø 50x8 - (P) 50 Rack-bolt with art.63 turn on rose 006 Ø50x8 - backset 50	•	•	•	6
63 CT 007	Catenaccio a cremagliera con art.63 su rosetta 007 mm 66x27 - (P) 50 Rack-bolt with art.63 turn on rose 007 mm 66x27 - backset 50	•	•	•	6



art. 512 CT

sporgenza ferro mm 50

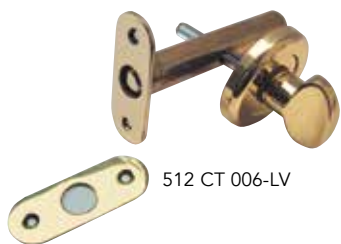

512 CT 006-LV



512 CT 007-OC

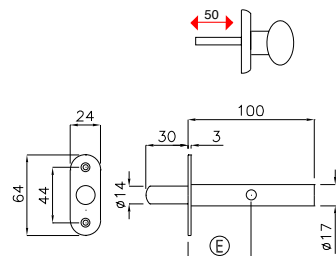

CATENACCIO A CREMAGLIERA / RACK-BOLT

512 CT 006	Catenaccio a cremagliera con art.512 su rosetta 006 Ø50x8 - (P) 50 Rack-bolt with art.512 turn on rose 006 Ø50x8 - backset 50				
512 CT 007	Catenaccio a cremagliera con art.512 su rosetta 007 mm 66x27 - (P) 50 Rack-bolt with art.512 turn on rose 007 mm 66x27- backset 50				



LV BG	OC OSC	OL	
•	•	•	6
•	•	•	6

art. 800 CE



destra/right

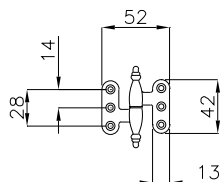

CERNIERA ALA TONDA / ROUND SIDE HINGES

800 CE	Cerniera Barocco Dx o Sx "Barocco" Hinges right or left			
--------	--	--	--	--



Extra per confezione self-service in blister da 2 pz. € 1,21
Extra for self-service blister packing 2 pcs.



OB	
•	24

Esempio: € 1,21 + PREZZO ARTICOLO X 2
Example: € 1,21 + ITEM PRICE X 2

art. 801 CE



destra/right

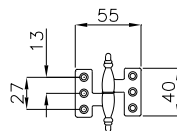

CERNIERA ALA QUADRA / SQUARE SIDE HINGES

801 CE	Cerniera Barocco Dx o Sx "Barocco" Hinges right or left			
--------	--	--	--	--



Extra per confezione self-service in blister da 2 pz. € 1,21
Extra for self-service blister packing 2 pcs.



OB	
•	24

Esempio: € 1,21 + PREZZO ARTICOLO X 2
Example: € 1,21 + ITEM PRICE X 2

art. 802 CE

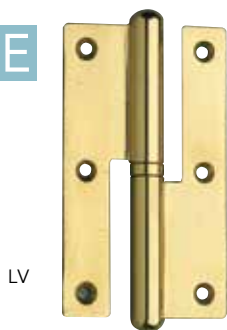

LV

destra/right

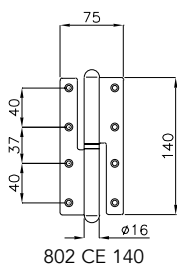

802 CE 140

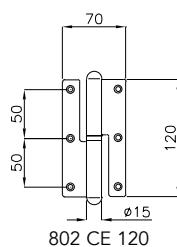

802 CE 120

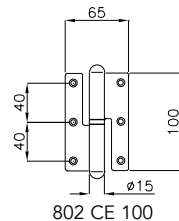

802 CE 100

CERNIERA A LIBRO / BOOK SHAPED HINGES

802 CE 100	Cerniera a libro mm 100 DX o SX Book-shaped hinges mm 100 right or left
802 CE 120	Cerniera a libro mm 120 DX o SX Book-shaped hinges mm 120 right or left
802 CE 140	Cerniera a libro mm 140 DX o SX Book-shaped hinges mm 140 right or left



OL	LV OB	OC	
•	•	•	12
•	•	•	12
•	•	•	12

art. 803 CE



LV

destra/right

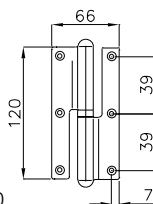

803 CE 120

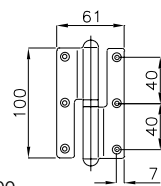

803 CE 100

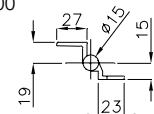
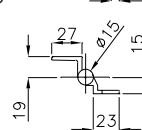

CERNIERA A LIBRO / BOOK SHAPED HINGES

803 CE 100	Cerniera zancata mm 100 DX o SX Clamped hinges mm 100 right or left
803 CE 120	Cerniera zancata mm 120 DX o SX Clamped hinges mm 120 right or left



OL	LV OB	OC	
•	•	•	12
•	•	•	12

art. 804 CE



OL

destra/right

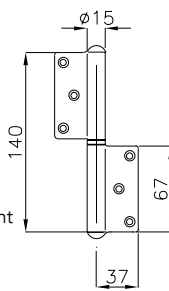

804 CE 140

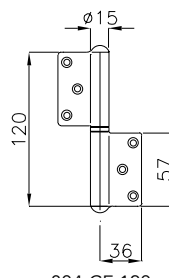

804 CE 120

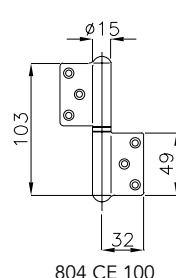

804 CE 100

CERNIERA IN GROSSEZZA/HINGES GROSSEZZA

804 CE 100	Cerniera in grossezza mm 100 DX o SX Hinges "Grossezza" mm 100 right or left
804 CE 120	Cerniera in grossezza mm 120 DX o SX Hinges "Grossezza" mm 120 right or left
804 CE 140	Cerniera in grossezza mm 140 DX o SX Hinges "Grossezza" mm 140 right or left



OL	LV OB	OC	
•	•	•	12
•	•	•	12
•	•	•	12

art. 809 CE

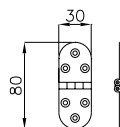
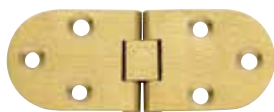

CERNIERA/ HINGES

809 CE

Cerniera con fermo mm 80x30
Hinges with lock



OS



Extra per confezione self-service in blister da 2 pz.
Extra for self-service blister packing 2 pcs.

€ 1,21

Esempio: € 1,21 + PREZZO ARTICOLO X 2
Example: € 1,21 + ITEM PRICE X 2

24

art. 810 CE

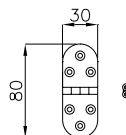

CERNIERA/ HINGES

810 CE

Cerniera senza fermo mm 80x30
Hinges without lock



OS



Extra per confezione self-service in blister da 2 pz.
Extra for self-service blister packing 2 pcs.

€ 1,21

Esempio: € 1,21 + PREZZO ARTICOLO X 2
Example: € 1,21 + ITEM PRICE X 2

24

art. 811 CE - 812 CE - 813 CE - 814 CE - 815 CE



811 CE



812 CE



813 CE



814 CE



815 CE

	L1	L2
811 CE	25	23
812 CE	37	23
813 CE	50	28
814 CE	62	37
815 CE	75	40

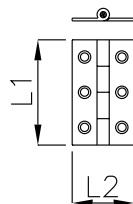

CERNIERA/ HINGES

811 CE 025

Cerniera da 25
Hinges mm 25

812 CE 040

Cerniera da 40
Hinges mm 40

813 CE 050

Cerniera da 50
Hinges mm 50

814 CE 065

Cerniera da 65
Hinges mm 65

815 CE 075

Cerniera da 75
Hinges mm 75



OL



Extra per confezione self-service in blister da 2 pz.
Extra for self-service blister packing 2 pcs.

€ 1,21

Esempio: € 1,21 + PREZZO ARTICOLO X 2
Example: € 1,21 + ITEM PRICE X 2

36

36

36

36

36

art. T33 SP



AGV

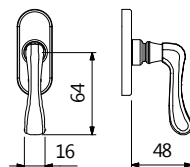

SEGRETINO PICCOLO

T33 SP 007

Segretino piccolo con rosetta
Small window handle on rose

007

mm 67x27 q. 7
mm 67x27 square spindle mm 7



LV	VBN	AGV	AN BGO	
•	•	•	•	12



Extra per confezione self-service in blister
Extra for self-service blister packing

€ 1,21

art. 33 SP



LV



OC

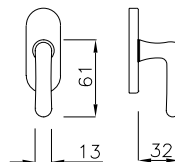

SEGRETINO PICCOLO

33 SP 007

Segretino piccolo con rosetta
Small window handle on rose

007

mm 67x27 q.6 o 7
mm 67x27 square spindle mm 6 or 7



LV BG	OC OSC	
•	•	12



Extra per confezione self-service in blister
Extra for self-service blister packing

€ 1,21

art. 36 SP



36 SP R36-L5



36 SP 007-LV

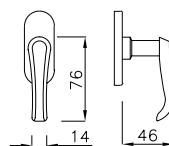

SEGRETINO PICCOLO

36 SP R36

Segretino piccolo con rosetta
Small window handle on rose

R36

mm 63x33 q.6 o 7
mm 63x33 square spindle mm 6 or 7



BS	LV LS	
•	•	12
	•	12

36 SP 007

Segretino piccolo con rosetta
Small window handle on rose

007

mm 67x27 q.6 o 7
mm 67x27 square spindle mm 6 or 7



Extra per confezione self-service in blister
Extra for self-service blister packing

€ 1,21

art. 63 SP



63 SP 007-LV



63 SP 007-OSC



63 SP 007-BG



63 SP 003-OC

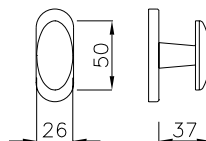

SEGRETINO PICCOLO

Art. No.	Description	Code	Dimensions	LV BG	OC OSC	Packaging
63 SP 007	Segretino piccolo con rosetta Small window handle on rose	007	mm 67x27 q.6, 7 o 8 mm 67x27 square spindle mm 6, 7 or 8	•	•	12
63 SP 003	Segretino piccolo con rosetta Small window handle on rose	003	Ø 45x7 q.6, 7 o 8 Ø 45x7 square spindle mm 6, 7 or 8	•	•	12



art. 70 SP



LV



BG



AN



AGV



Extra per confezione self-service in blister
Extra for self-service blister packing

€ 1,21

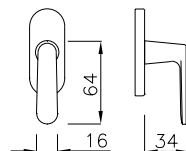

SEGRETINO PICCOLO

Art. No.	Description	Code	Dimensions	LV BG	OC OSC	AN	AGV	Packaging
70 SP 007	Segretino piccolo con rosetta Small window handle on rose	007	mm 67x27 q. 6, 7 o 8 mm 67x27 square spindle mm 6, 7 or 8	•	•	•	•	12



art. 77 SP



BS

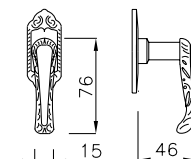

Extra per confezione self-service in blister
Extra for self-service blister packing

€ 1,21

SEGRETINO PICCOLO

Art. No.	Description	Code	Dimensions	BS	Packaging
77 SP 034	Segretino piccolo con rosetta Small window handle on rose	034	mm 85x33 q. 6 o 7 mm 85x33 square spindle mm 6 or 7	•	12



Extra per confezione self-service in blister
Extra for self-service blister packing

€ 1,21

art. 97 SP



97 SP 007-OSC



97 SP 007-LV

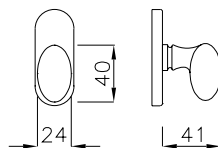

LV
OB

OC
OSC



SEGRETINO PICCOLO

97 SP 007	Segretino piccolo con rosetta Small window handle on rose	007	mm 67x27 q. 6, 7 o 8 mm 67x27 square spindle mm 6, 7 or 8	•	•	12
-----------	--	-----	--	---	---	----



Extra per confezione self-service in blister
Extra for self-service blister packing

€ 1,21

art. 63 SP - 97 SP C07



63 SP C07-LV

solo fisso
only fixed



97 SP C07-OC



97 SP C07-OB

solo fisso
only fixed



Piastrina P5



LV
OB

OC
OSC



SEGRETINO PICCOLO

63 SP C07	Segretino piccolo con rosetta Small window handle on rose	C07	mm 67x27 fisso con piastrina mm 67x27 fixed with fixing base	•	•	12
97 SP C07	Segretino piccolo con rosetta Small window handle on rose	C07	mm 67x27 fisso con piastrina mm 67x27 fixed with fixing base	•	•	12

art. 166 SP

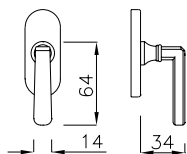

166 SP 007-LV



166 SP 007-AN



166 SP 007-AGV



166 SP 166-LV



LV

AN

AGV



SEGRETINO PICCOLO

166 SP 007	Segretino piccolo con rosetta Small window handle on rose	007	mm 67x27 q. 6 o 7 mm 67x27 square spindle mm 6 or 7	•	•	14,61	12
166 SP 166	Segretino piccolo con rosetta Small window handle on rose	166	mm 65x28 q. 6 o 7 mm 65x28 square spindle mm 6 or 7	•			12



Extra per confezione self-service in blister
Extra for self-service blister packing

€ 1,21

art. 512 SP

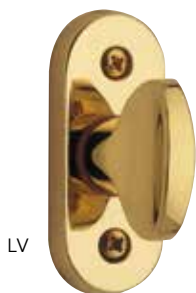

LV



OC



OSC

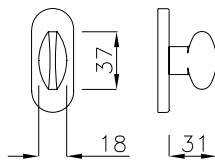

SEGRETINO PICCOLO

512 SP 007

Segretino piccolo con rosetta
Small window handle on rose

007

mm 67x27 q. 6, 7 o 8
mm 67x27 square spindle mm 6, 7 or 8



LV
BG

OC
OSC



•

•

12



Extra per confezione self-service in blister
Extra for self-service blister packing

€ 1,21

art. 514 SP



LV



BG



OSC

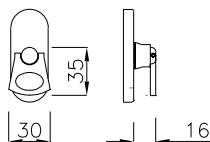

SEGRETINO PICCOLO CON PENDENTE

514 SP 007

Segretino piccolo con rosetta
Small window handle on rose

007

mm 67x27 q. 6 o 7
mm 67x27 square spindle mm 6 or 7



LV
BG

OC
OSC



•

•

12



Extra per confezione self-service in blister
Extra for self-service blister packing

€ 1,21

art. 40 MM

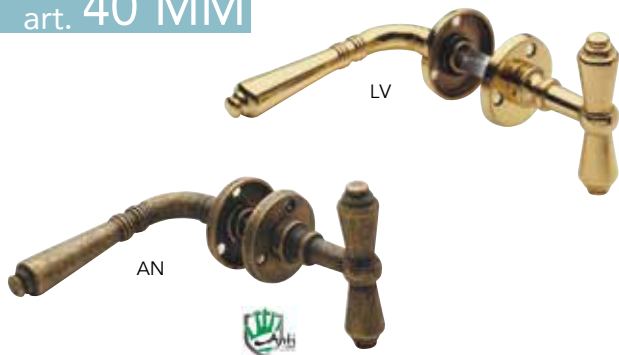

LV

AN



AGV



LV
BG

LR
VBN

AN

AGV



COPPIA MARTELLINA / MANIGLIA

40 MM R40

Coppia martellina/maniglia q.8 con rosetta R40 Ø 45 con bocchetta
Pair window handle/lever handle q.8 with rose R40 Ø 45 with key rose

•

•

•

•

1

art. 191 MM



LV



COPPIA MARTELLINA / MANIGLIA		LV BG	LR VBN	AN	AGV	
191 MM R40	Coppia martellina/maniglia q.8 con rosetta R40 Ø 45 con bocchetta Pair window handle/lever handle q.8 with rose R40 Ø 45 with key rose	•	•	•	•	1

art. 190 MR



LV



COPPIA MANIGLIA A "T" / "T" SHAPE LEVER HANDLE		LV BG	LR VBN	AN	AGV	
190 MR R40	Coppia maniglia q.8 con rosetta R40 Ø 45 con bocchetta Pair lever handle q.8 on rose R40 Ø 45 with key rose	•	•	•	•	1

art. 40 MA



LV

AN

AGV



MARTELLINA / WINDOW HANDLE		LV BG	LR VBN	AN	AGV	
40 MA 007	Martellina con rosetta 007 mm 67x27 ovale con q. 7 Window handle on oval rose 007 mm 67x27 with square spindle mm 7	•	•	•	•	6

art. 40 MA

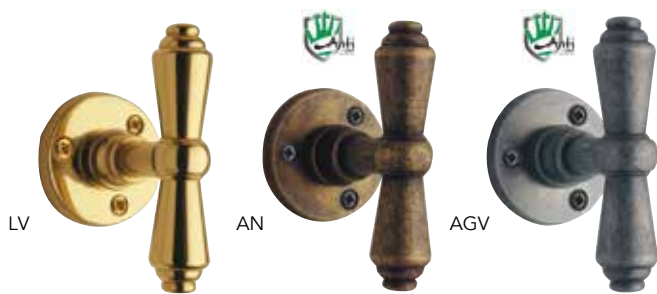

MARTELLINA

40 MA R40

Martellina con rosetta R40 Ø 45 con q.7
Window handle on oval rose R40 with square spindle mm 7

LV
BG

LR
VBN

AN

AGV



•

•

•

•

6

art.190 MA

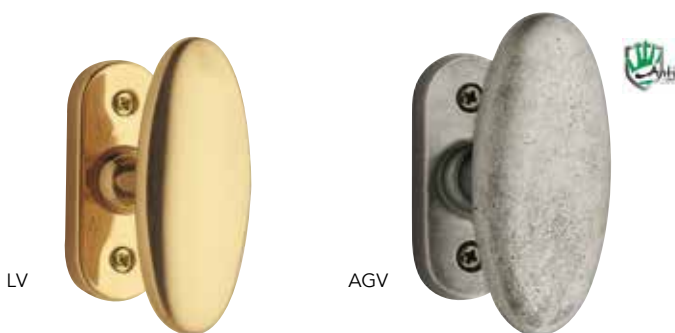

MARTELLINA

190 MA 007

Martellina con rosetta 007 mm 67x27 ovale con q. 7
Window handle on oval rose 007 mm 67x27 with square spindle mm 7

LV
BG

LR
VBN

AN

AGV



•

•

•

•

6

art.190 MA



MARTELLINA

190 MA R40

Martellina con rosetta R40 Ø 45 con q.7
Window handle on oval rose R40 with square spindle mm 7

LV
BG

LR
VBN

AN

AGV



•

•

•

•

6

art. 31 CB

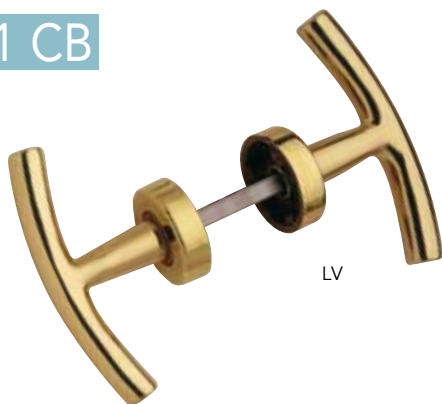

LV

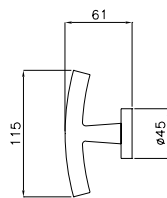

COPPIA MARTELLINA PER BASCULANTI

31 CB 004

Coppia martellina su rosetta
Pair window handles on rose

004

Ø 45x9 q. 8
Ø 45x9 square spindle 8



LV	BG	
•	•	2

art. 415 CB



NR



CROMATO

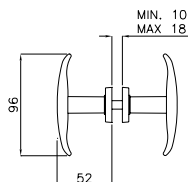

COPPIA MARTELLINA PER BASCULANTI

415 CB 414

Coppia martellina su rosetta
Pair window handles on rose

414

Ø 32 con vite in testa q.8
Ø 32 with screw square spindle 8



NR	CROMATO	
•	•	12

art. 414 MR



NR



CROMATO

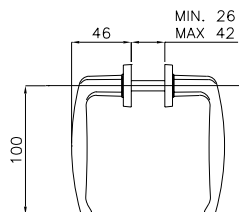

MANIGLIA PER SERRAMENTI IN FERRO / LEVER HANDLES FOR IRON FRAMES

414 MR 414

Maniglia con rosetta
Lever handle on rose

414

Ø 32 con vite in testa q. 8
Ø 32 with screw square spindle 8



NR	CROMATO	
•	•	12
•	-	12

414 MR 414

Maniglia con rosetta
Lever handle on rose

414

Ø 35 con grano
Ø 35 with grub screw

art. 69 MB

incontro/striker



destra/right

69 MB 001-BN/LV



sinistra/left

69 MB 001-NR/LV



destra/right

69 MB 001-BN/OC



sinistra/left

69 MB 001-NR/OC



		BN/LV	BN/OL	BN/OC BN/OSC	CHAMP/LV NR/LV	CHAMP/OL NR/OL	NR/OC NR/OSC	OL	LV	OC	OSC	
MANIGLIA DA BLOCCO PORCELLANA / PORCELAIN LOCKING HANDLE												
69 MB 001	Maniglia da blocco dx o sx con incontro Locking handle right or left with striker	•	•	•	•	•	•					8
69 MB 002	Maniglia da blocco dx o sx senza incontro Locking handle right or left without striker	•	•	•	•	•	•					8
196 IN	Solo incontro per art.69 mm 63x18 Only striker for art.69 mm 63x18							•	•	•	•	50

art. 86 MB

incontro/striker



destra/right

86 MB 001-CH/LV



sinistra/left

86 MB 001-SC/LV



destra/right

86 MB 001-SC/OC



sinistra/left

86 MB 001-SC/OSC



		CH/LV SC/LV	LNR/ LV	CH/OL SC/OL	LNR/OL	SC/OC SC/OSC	
MANIGLIA DA BLOCCO LEGNO / WOOD LOCKING HANDLE							
86 MB 001	Maniglia da blocco dx o sx con incontro Locking handle right or left with striker	•	•	•	•	•	8
86 MB 002	Maniglia da blocco dx o sx senza incontro Locking handle right or left without striker	•	•	•	•	•	8

art. 196 MB



196 MB 002-OC

sinistra/left



196 MB 002-OL

destra/right



incontro/striker

196 IN-OL

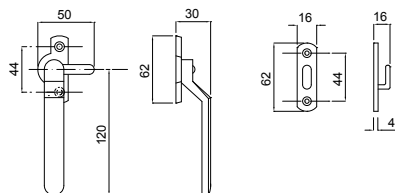

MANIGLIA DA BLOCCO DIRITTA MM 125 / STRAIGHT LOCKING HANDLE

196 MB 001	Maniglia da blocco dx o sx con incontro Locking handle right or left with striker
196 MB 002	Maniglia da blocco dx o sx senza incontro Locking handle right or left without striker
196 IN	Solo incontro per art.196 mm 63x18 Only striker for art.196 mm 63x18



	OL	OB	OC	
196 MB 001	•	•	•	20
196 MB 002	•	•	•	20
196 IN	•	•	•	50



Extra per confezione self-service in blister
Extra for self-service blister packing

€ 1,21

art. 202 MB



incontro/striker



202 MB 001-OL

sinistra/left



202 MB 002-OC

destra/right

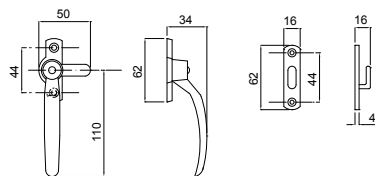

MANIGLIA DA BLOCCO CURVA MM 110 / CAMBERED LOCKING HANDLE

202 MB 001	Maniglia da blocco dx o sx con incontro Locking handle right or left with striker
202 MB 002	Maniglia da blocco dx o sx senza incontro Locking handle right or left without striker



	OL	OB	OC	
202 MB 001	•	•	•	20
202 MB 002	•	•	•	20



Extra per confezione self-service in blister
Extra for self-service blister packing

€ 1,21

art. **K90** MANIGLIONI PER STUFE E FORNI

materiale: Ottone - Legno
material: Solid Brass - Wood



K90 MD ***16 - SC/LV

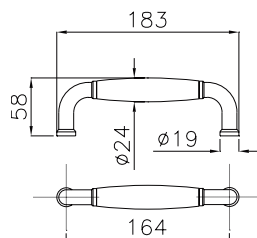

K90 MD ***16 - SC/OSC

MANIGLIONE DIRITTO SINGOLO / SINGLE STRAIGHT PULL HANDLE

K90 MD ***16

Maniglione diritto singolo int. mm. 164 filetto M6
Single straight pull handle mm 164 threaded M6



SC/LV	SC/OSC	
•	•	6

art. **K90** MANIGLIONI PER STUFE E FORNI

materiale: Ottone - Legno
material: Solid Brass - Wood



K90 MD ***23 - SC/LV

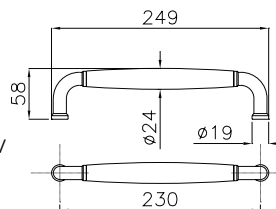

K90 MD ***23 - SC/OSC

MANIGLIONE DIRITTO SINGOLO / SINGLE STRAIGHT PULL HANDLE

K90 MD ***23

Maniglione diritto singolo int. mm. 230 filetto M6
Single straight pull handle mm 230 threaded M6



SC/LV	SC/OSC	
•	•	6

art. **K24 PN**

materiale: Ottone
material: Solid Brass



K24 PN - LV



K24 PN - OSC



K24 PN - OC



viste laterali e filetto M8

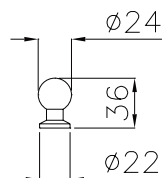

POMOLINO

K24 PN

Pomolino Ø24 con filetto M8
Small knob Ø24 threaded M8



LV	OC	OSC	
•	•	•	50

art. 20 CH

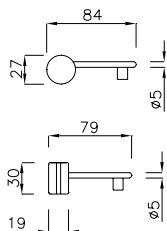

20 CH T00-LV 20 CH T00-AN 20 CH T00-AGV 20 CH R00-LV

CHIAVE / KEY

		LV BG	OC OSC	AN	AGV	
20 CH T00	Chiave tonda Round key	•	•	•	•	25
20 CH R00	Chiave rettangolare Rectangular key	•				25



Extra per confezione self-service in blister
Extra for self-service blister packing

€ 1,07

art. 21 CH

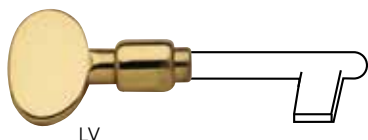

LV

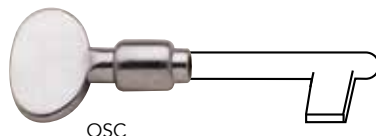

OSC

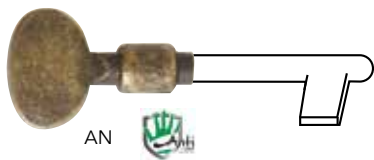

AN

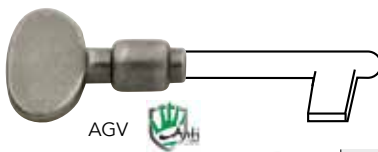

AGV

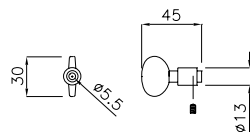

COPRICHIAVE / COVER KEY

		LV BF	OC OSC	AN	AGV	
21 CH	Coprichiave universale con grano Cover key with grub screw	•	•	•	•	30



Extra per confezione self-service in blister
Extra for self-service blister packing

€ 1,07

art. 22 CH

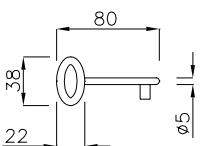

LV



AN



AGV

CHIAVE OVALE / OVAL KEY

		LV BG	AN	AGV	
22 CH	Chiave ovale Oval key	•	•	•	25



Extra per confezione self-service in blister
Extra for self-service blister packing

€ 1,07

art. 301 PT



* a richiesta / on request

PORTACHIAVI IN OTTONE / BRASS KEY RING

301 PT Portachiavi "Family Hope" in ottone*
Brass "Family Hope" Key ring*



	OSC	AZZURRO	
	•	•	50

* a richiesta portachiavi personalizzato - ordine minimo 500 pezzi
* different options on request - minimum order 500 pcs

art. 637 DD



LV

OSC

OB

DADO DOPPIO FILETTO / DOUBLE THREADED NUT

637 DD Dado Ø20 con doppio filetto per troncone M8/M10
Double threaded nut Ø20 for screw M8/M10



	LV OB	OC OSC	PVD	
	•	•	•	24



Extra per confezione self-service in blister
Extra for self-service blister packing

€ 1,07

art. 638 DD

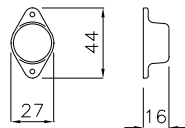

LV

OB

OC

COPRIDADO IN OTTONE / BRASS COVER-NUT

638 DD Copridado
Cover-nut



	LV OB	OC OSC	
	•	•	50



Extra per confezione self-service in blister
Extra for self-service blister packing

€ 1,07

SOLUZIONI TECNICHE E COMPONENTI

TECHNICAL SOLUTIONS AND COMPONENTS





R16 SYSTEM

ADATTO A VITI PASSANTI PER SERRATURE SCANDINAVIA
SUITABLE FOR BOLT THROUGH FIXINGS FOR SCANDINAVIAN LOCKS

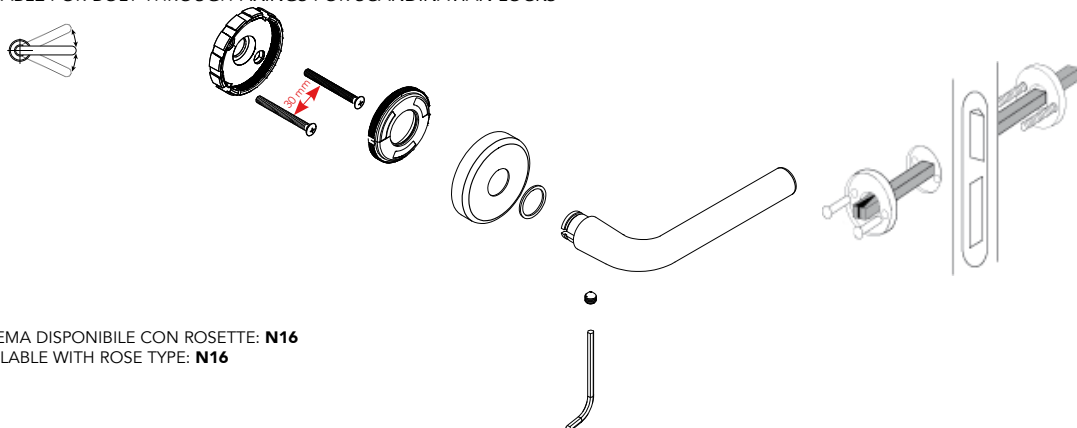

SISTEMA DISPONIBILE CON ROSETTE: **N16**
AVAILABLE WITH ROSE TYPE: **N16**

R16 SYSTEM

PER VITI A LEGNO
FOR WOODEN SCREWS

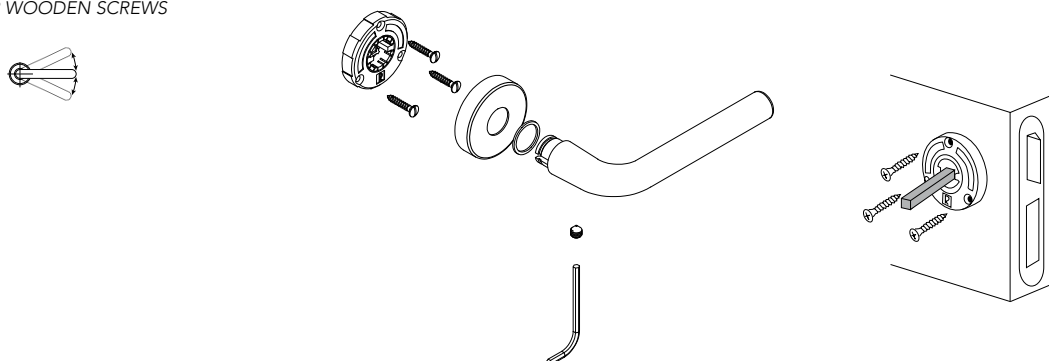

SISTEMA DISPONIBILE CON ROSETTE: **416 - 816 - 916 - 9Q6 - Q46 - Q86 - Q56 - 199 - J08 - JQ8**
AVAILABLE WITH ROSE TYPE: **416 - 816 - 916 - 9Q6 - Q46 - Q86 - Q56 - 199 - J08 - JQ8**

R16 SYSTEM

ADATTO A VITI PASSANTI PER SERRATURE CON FORI VITI INTERASSE 38 mm
SUITABLE FOR BOLT THROUGH FIXINGS LOCKS WITH 38 CC SCREW HOLES

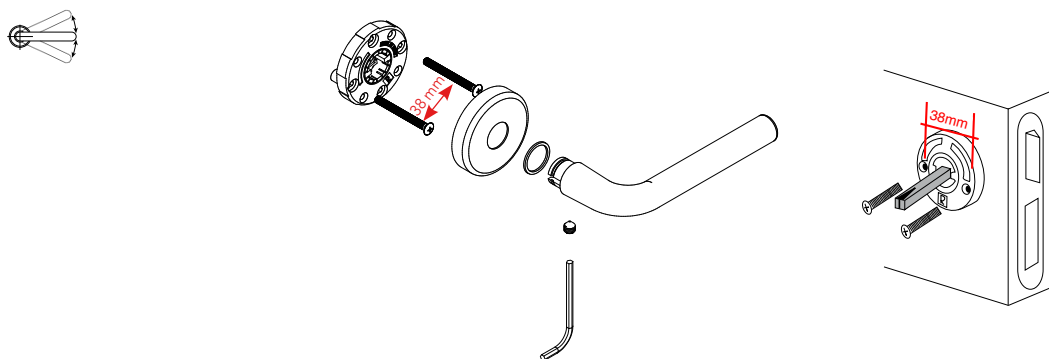

SISTEMA DISPONIBILE CON ROSETTE: **816 - D16 - Q86 - QD6 - 56D - 99D - Q56 - 199 - J08 - JQ8**
AVAILABLE WITH ROSE TYPE: **816 - D16 - Q86 - QD6 - 56D - 99D - Q56 - 199 - J08 - JQ8**

R1 SYSTEM

Sistema di assemblaggio placche o rosette con molla
System for roses and plates with returning spring

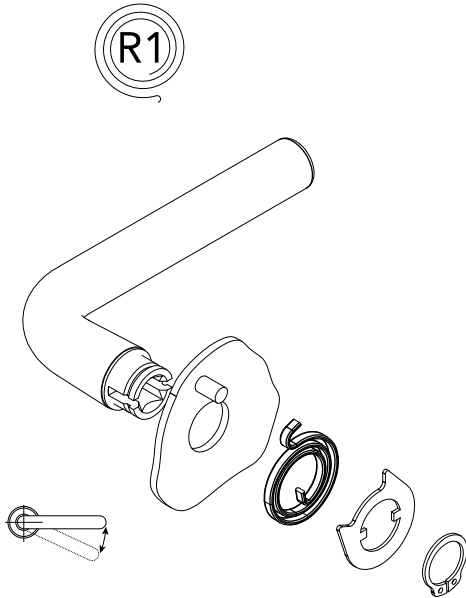

Vedi pag. 11 - See page 11

R38 SYSTEM

Sistema con viti passanti interasse 38, rosetta copriviti e molla di ritorno bidirezionale
Bolt through screws system with cover screws rose and bidirectional returning spring

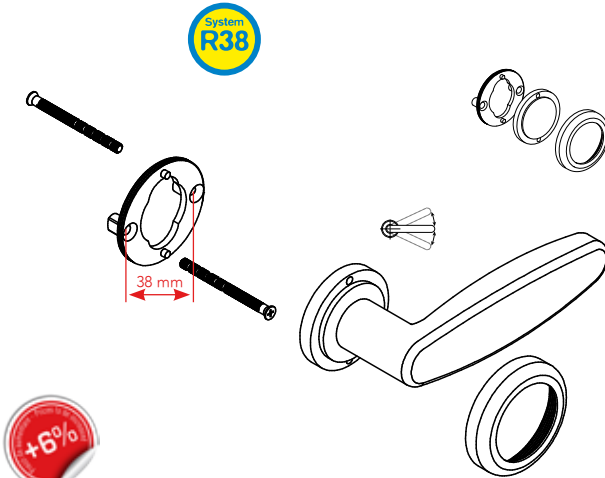

Tutte le nostre maniglie possono essere fornite con rosetta e bocchetta SYSTEM R38 sostituendo le rosette 005 e 006 con rosette D38 o 38D, e la rosetta 382 con rosette D73 o 73D.
Extra prezzo € 8,98

Every lever handles can be supplied with rose and rose for key R38 SYSTEM, replacing the roses 005 and 006 with roses D38 or 38D, and the rose 382 with the roses D73 or 73D.
Extra price € 8,98



Vedi pag. 10 - See page 10

SYSTEM 2000

Sistema viti passanti per serrature scandinavia con fori viti interasse 30mm
Bolt through screws system suitable for scandinavian locks with cc 30mm



system
2000

PATENTED UNIVERSAL SYSTEM WITH
 COVER SCREW ROSE, AND BIDIRECTIONAL RETURNING SPRING

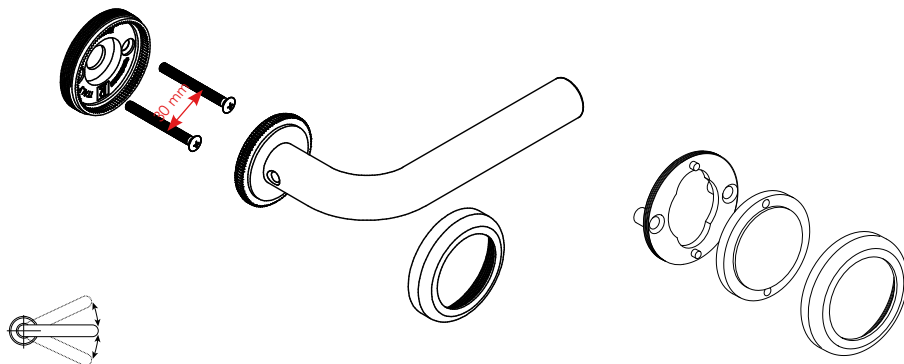

SISTEMA DISPONIBILE CON ROSETTE: **R73 - 206**
 AVAILABLE WITH ROSE TYPE: **R73 - 206**

SYSTEM N08

Sistema viti passanti per serrature con interasse 30 mm o con interasse 38 mm
Bolt through screws system for locks with cc 30 mm or cc 38 mm screw holes

System
N08

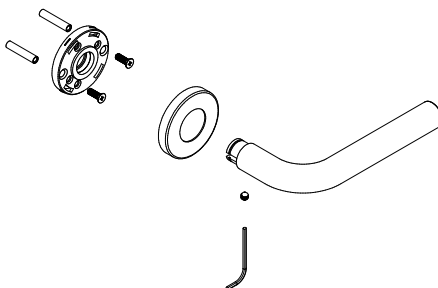
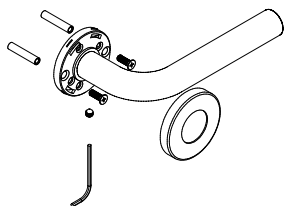
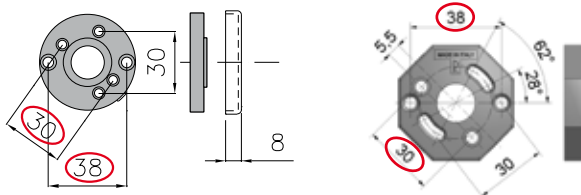

N08 SYSTEM

Con rosetta maniglia già montata
With rose mounted on lever handle

N08 SYSTEM

Con rosetta maniglia smontata
With loose rose

SISTEMA DISPONIBILE CON ROSETTE: **N08 - QN6 - 806 - 8D6**
 AVAILABLE WITH ROSE TYPE: **N08 - QN6 - 806 - 8D6**

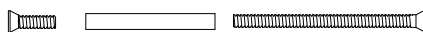

Sistema viti di connessione per N08
Bolt through screws system for N08

RPM SYSTEM

Sistema **R**egolazione **P**osizione **M**aniglia
With adjusting system for door handle position

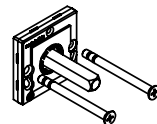
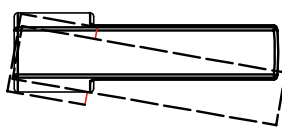
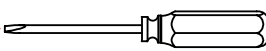
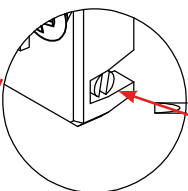
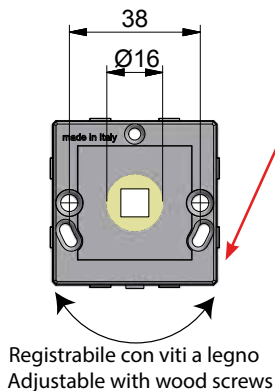

Mounting system
rose 99D

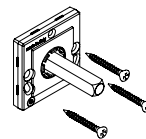

Mounting system
rose 199

SISTEMA DISPONIBILE CON ROSETTE: 199 - 99D
AVAILABLE WITH ROSE TYPE: 199 - 99D

AUSTRALIA SYSTEM

AUSTRALIA SYSTEM Ø52

For privacy and passage latches - backset mm 60-70 for rose Ø52

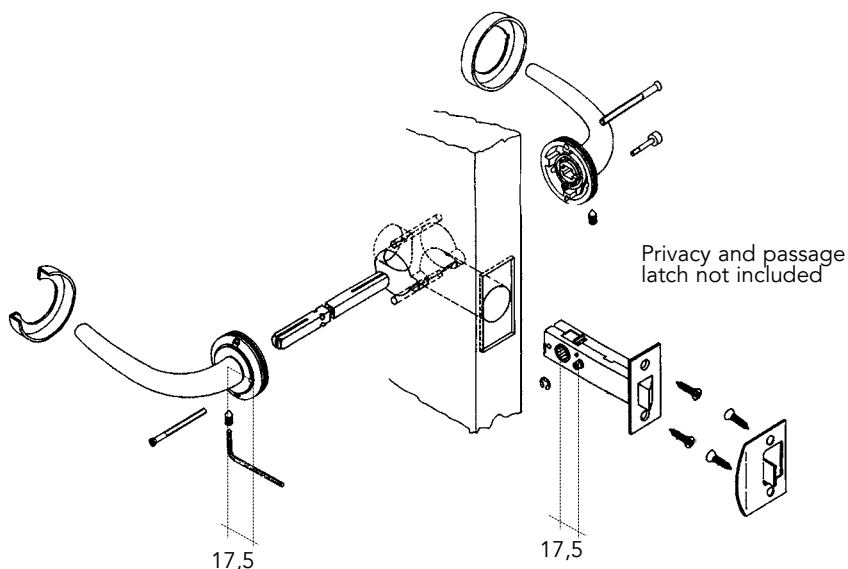

SISTEMA DISPONIBILE CON ROSETTE: A52 - P52 - A62 - P62
AVAILABLE WITH ROSE TYPE: A52 - P52 - A62 - P62

NORTH AMERICA SYSTEM

FOR PRIVACY AND PASSAGE LATCHES

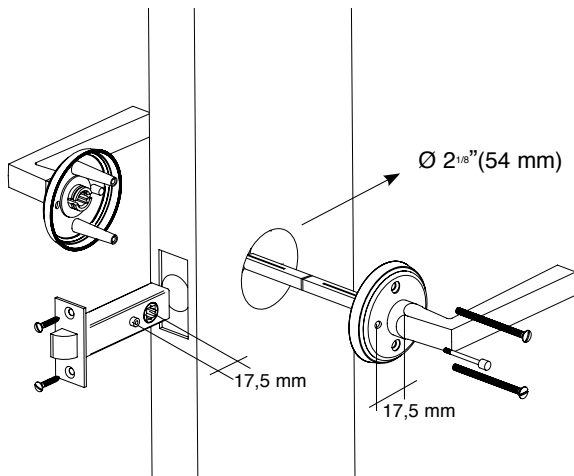

SISTEMA DISPONIBILE CON ROSETTE: **A64 - P64 - A67 - P67**
 AVAILABLE WITH ROSE TYPE: **A64 - P64 - A67 - P67**

ENTRY SET

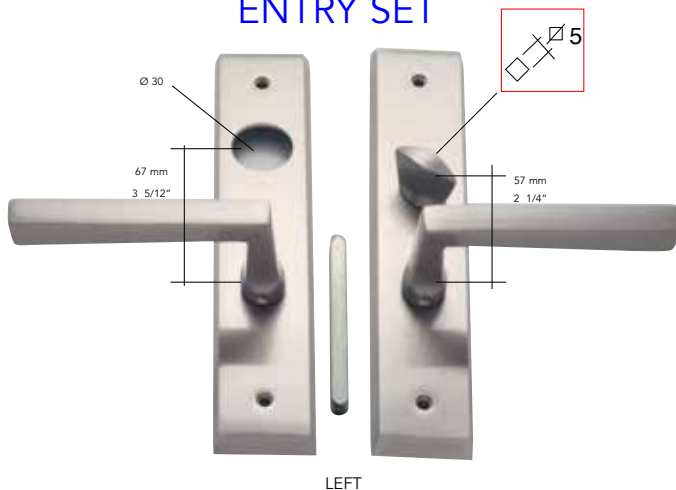

LEFT

PASSAGE

PRIVACY

DUMMY

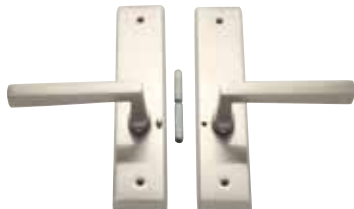



SIMBOLI SISTEMI FISSAGGIO ROSETTE E PLACCHE FIXING SYSTEM SYMBOLS FOR ROSES AND PLATES



FISSAGGIO VITI DI CONNESSIONE **STANDARD**
STANDARD BOLT THROUGH SCREWS FIXING SYSTEM

System
N08

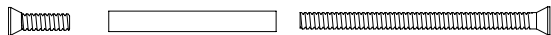

FISSAGGIO VITI DI CONNESSIONE SYSTEM **N08**
BOLT THROUGH SCREWS FIXING SYSTEM **N08**
Per rosette N08 - QN6 - 005 - 006 - 011

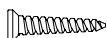

FISSAGGIO VITI A LEGNO
WOODEN SCREWS FIXING

SIMBOLI APPLICAZIONE MOLLA RETURNING SPRING APPLICATION SYMBOLS

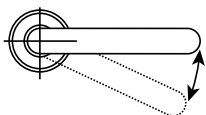

ADATTABILITA' AD APPLICAZIONE MOLLA
SUITABLE FOR RETURNING SPRING APPLICATION

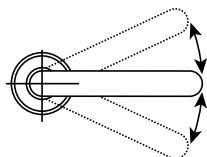

ADATTABILITA' AD APPLICAZIONE MOLLA AMBIDESTRA
SUITABLE FOR LH/RH RETURNING SPRING APPLICATION

SIMBOLO PER ROSETTE E BOCCHETTE ROSE AND KEY ROSE SYMBOL

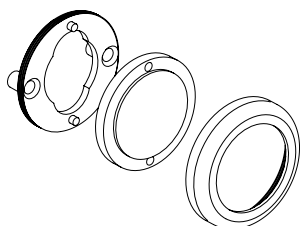

ROSETTA O BOCCHETTA IN TRE PEZZI
ROSE OR KEY ROSE COMPOSED BY THREE PIECES

SERVIZI PER MIGLIORARE ULTERIORMENTE IL FISSAGGIO MANIGLIE SULLE PORTE
Services for further improving the fixing on the doors

SMG

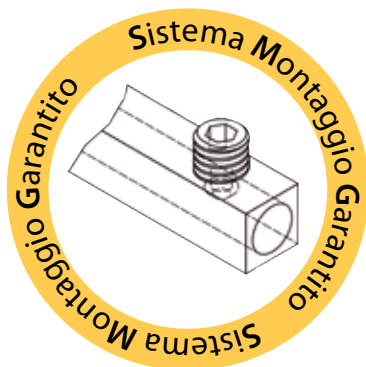

SMG - Sistema Montaggio Garantito con ferro forato e grani speciali CDF6

VANTAGGIO:

- Fissaggio stabile e duraturo del grano sul ferro e quindi, della maniglia sulla porta

Extra prezzo di listino per servizio a richiesta € 1,00 cad. maniglia



S M R

Servizio Montaggio Rapido
con Grani Premontati



VANTAGGI:

- Semplificazione e riduzione significativa del tempo di montaggio della maniglia sulla porta

SERVIZIO DISPONIBILE A RICHIESTA

versione con rosette e bocchette
foro chiave patent

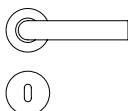

SERVIZIO DISPONIBILE A RICHIESTA

art.002 RO



002 RO

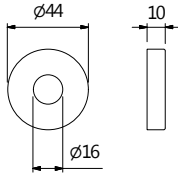

Esempio di applicazione
Mounting example

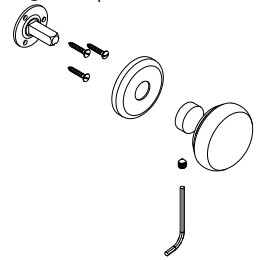

Finiture
Finishes

LV BG	OC OSC	PVD	PVD INOX	AN BGO
€	€	€	€	€
•	•	•	•	•

ROSETTA Ø45

002 RO Rosetta coprivate per rosetta 416/406 RO e copripiastina per montaggio pomoli-maniglioni-battenti
Cover screw rose for 416/406 RO and cover fixing base for assembly knobs-pull handles and door knockers

art.003 RO



003 RO

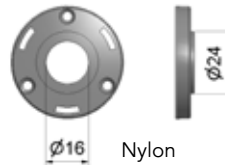
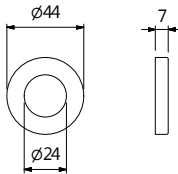

Esempio di applicazione
Mounting example

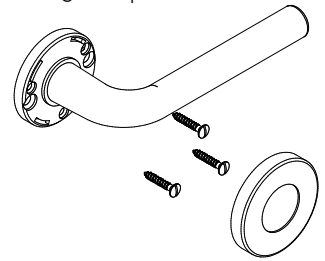

SISTEMA DI MONTAGGIO STANDARD
STANDARD MOUNTING SYSTEM



ROSETTA Ø45

003 RO Rosetta coprivate adatta ad applicazione molla
Cover screw rose, suitable to insert returning spring

art.004 RO



004 RO

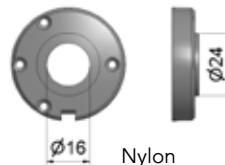
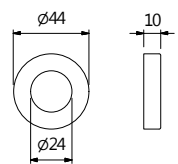

Esempio di applicazione
Mounting example

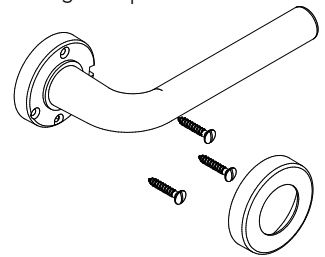

SISTEMA DI MONTAGGIO STANDARD
STANDARD MOUNTING SYSTEM



ROSETTA Ø45

004 RO Rosetta coprivate adatta ad applicazione molla
Cover screw rose, suitable to insert returning spring

art.005 RO



005 RO

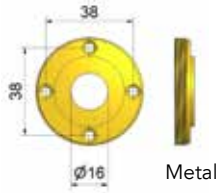
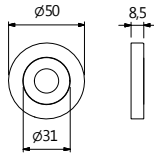

Metal

Esempio di applicazione
Mounting example

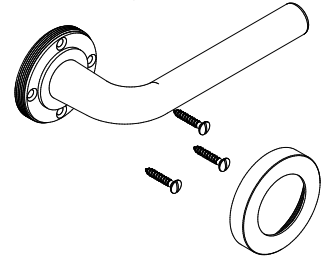

SISTEMA DI MONTAGGIO STANDARD
STANDARD MOUNTING SYSTEM



SISTEMA DI MONTAGGIO A RICHIESTA
ON REQUEST MOUNTING SYSTEM



ROSETTA Ø50

005 RO Rosetta coprivite tipo lusso, adatta ad applicazione molla
Lusso type cover screws rose, suitable to insert returning spring

art.006 RO



006 RO

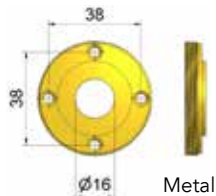
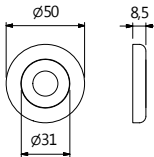

Metal

Esempio di applicazione
Mounting example

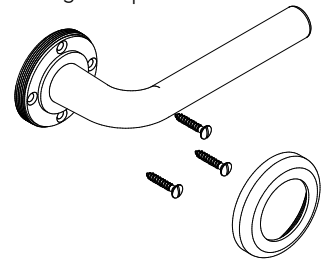

SISTEMA DI MONTAGGIO STANDARD
STANDARD MOUNTING SYSTEM



SISTEMA DI MONTAGGIO A RICHIESTA
ON REQUEST MOUNTING SYSTEM



ROSETTA Ø50

006 RO Rosetta coprivite tipo lusso, adatta ad applicazione molla
Lusso type cover screws rose, suitable to insert returning spring

art.007 RO



007 RO

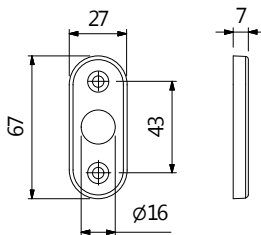

Esempio di applicazione
Mounting example

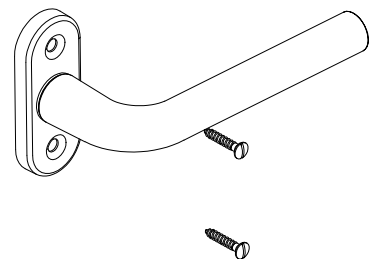

SISTEMA DI MONTAGGIO STANDARD
STANDARD MOUNTING SYSTEM



ROSETTA OVALE STRETTA

007 RO Rosetta ovale stretta mm 67X27
Reduced oval rose mm 67X27

art.008 RO



008 RO

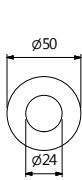

Nylon

Esempio di applicazione
Mounting example

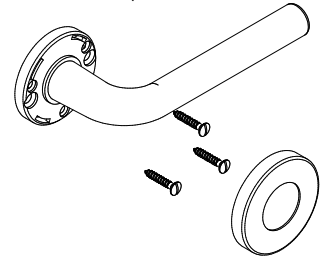

SISTEMA DI MONTAGGIO STANDARD
STANDARD MOUNTING SYSTEM



SISTEMA DI MONTAGGIO A RICHIESTA
ON REQUEST MOUNTING SYSTEM



ROSETTA Ø50

008 RO Rosetta coprivite adatta ad applicazione molla
Cover screw rose, suitable to insert returning spring

art.009 RO



009 RO

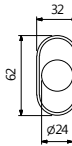

Nylon

Esempio di applicazione
Mounting example

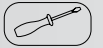
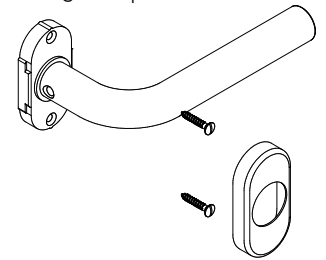

SISTEMA DI MONTAGGIO STANDARD
STANDARD MOUNTING SYSTEM



ROSETTA COPRIVITE OVALE

009 RO Rosetta coprivite ovale mm 62x32 adatta ad applicazione molla
Oval cover screws rose mm 62x32 suitable to insert returning spring

art.011 RO



011 RO

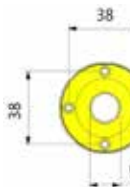
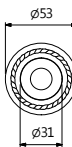

Metal

Esempio di applicazione
Mounting example

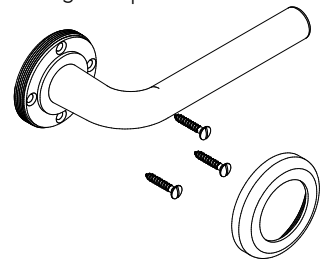

SISTEMA DI MONTAGGIO STANDARD
STANDARD MOUNTING SYSTEM



SISTEMA DI MONTAGGIO A RICHIESTA
ON REQUEST MOUNTING SYSTEM



ROSETTA ELEMENTIA Ø53

011 RO Rosetta coprivite tipo lusso adatta ad applicazione molla
Lusso type cover screw rosette suitable to insert returning spring



art.015 RO



015 RO

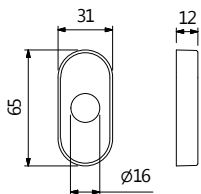

Esempio di applicazione
Mounting example

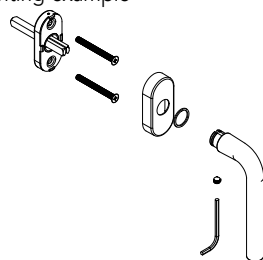

ROSETTA STANDARD PER MOVIMENTO DK MM 65X31

015 RO Rosetta standard per movimento DK M1
Standard rose for M1 DK mechanism



Finiture Finishes	LV OS BG	OC OSC	PVD	AGV	AN
	€	€	€	€	€
	•	•	•	•	•

art.022 RO minimal line



022 RO

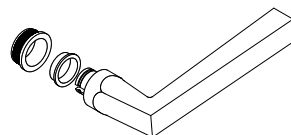
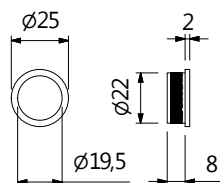

Esempio di applicazione
Mounting example



SISTEMA DI MONTAGGIO STANDARD
STANDARD MOUNTING SYSTEM



COLLA / GLUE

ROSETTA MINIMAL LINE

022 RO Rosetta MINIMAL tonda d.25
MINIMAL round rose D.25



Finiture Finishes	LV	OC	OSC	SNV	PVD INOX
	€	€	€	€	€
	•	•	•	•	•

art.024 RO



024 RO

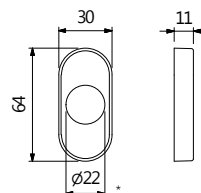

* DISPONIBILE ANCHE CON FORO Ø 24
AVAILABLE WITH HOLE Ø24

Esempio di applicazione
Mounting example

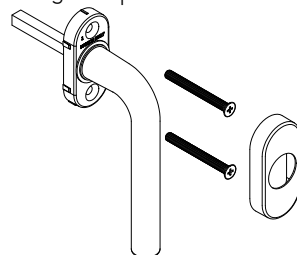

ROSETTE PER MOVIMENTO DK 024 MM 64X30

024 RO Rosetta per movimento DK 024 preassemblato sull'impugnatura (senza grano)
Rose for DK 024 pre-assembled mechanism without grub screw



Finiture Finishes	LV BG	OC OSC	PVD
	€	€	€
	•	•	•

art.025 RO



025 RO

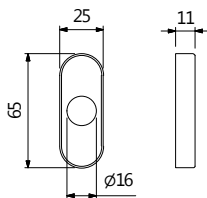

Esempio di applicazione
Mounting example

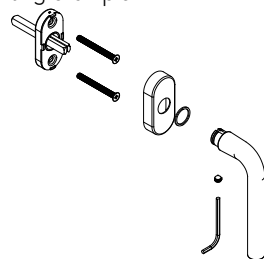

ROSETTA PER MOVIMENTO DK MM 25X65

025 RO Rosetta per movimento DK stretto (M5)
Rose for reduced DK mechanism (M5)



Finiture Finishes	LV	BG	OC	OSC
	€	€	€	€
	•	•	•	•

art.062 RO



062 RO

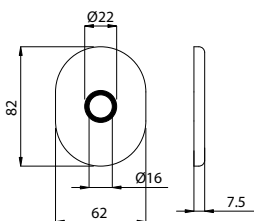

Esempio di applicazione
Mounting example

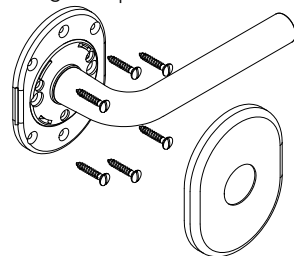

Nylon



SISTEMA DI MONTAGGIO STANDARD
STANDARD MOUNTING SYSTEM



SISTEMA DI MONTAGGIO A RICHIESTA
ON REQUEST MOUNTING SYSTEM



ROSETTA PER PORTE BLINDATE

062 RO Rosetta coprivite
Cover screws rose



Finiture Finishes	LV	BG	OC	OSC	PVD
	€	€	€	€	€
	•	•	•	•	•

art.074 RO



A074 RO

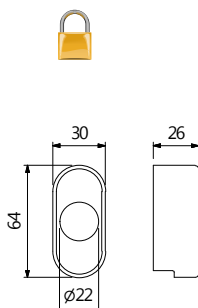

* DISPONIBILE ANCHE CON FORO Ø 24
AVAILABLE WITH HOLE Ø24

Esempio di applicazione
Mounting example

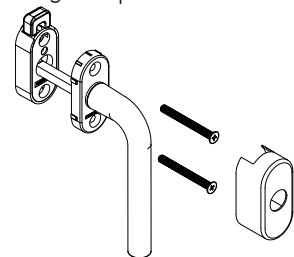

calcolo prezzi rispetto ai dk standard ...DK024, extra prezzo rispetto a...DK074
pricing calculation compare to our standard ...DK024, extra price from ...DK074



Finiture Finishes	LV	BG	OC OSC	PVD
	€	€	€	€
	•	•	•	•

ROSETTA CON PULSANTE DI SICUREZZA PER DK

A074 RO Rosetta DK con pulsante senza movimento
Rose for DK with push-button without mechanism

art.075 RO



A075 RO

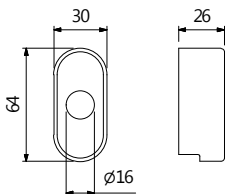

Esempio di applicazione
Mounting example

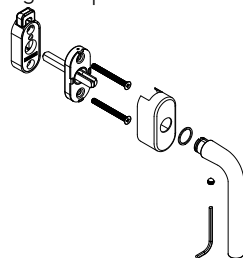

disponibile l'abbinamento per ogni maniglia
available for every lever handle

CALCOLO PREZZI /PRICING CALCULATION
...DK075 Extra prezzo rispetto a ...DK015
...DK075 Extra price from ...DK015



Finiture
Finishes

LV	OC	SNV	PVD	VBN	AGV	AN
BG	OSC					
€	€	€	€	€	€	€
•	•	•	•	•	•	•

ROSETTA CON PULSANTE DI SICUREZZA PER DK

A075 RO Rosetta DK con pulsante senza movimento
Rose for DK with button without mechanism

art.098 RO



098 RO

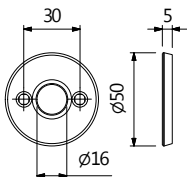

Esempio di applicazione
Mounting example

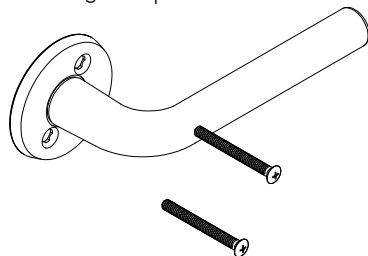

SISTEMA DI MONTAGGIO STANDARD
STANDARD MOUNTING SYSTEM



SISTEMA DI MONTAGGIO A RICHIESTA
ON REQUEST MOUNTING SYSTEM



ROSETTA Ø50

098 RO Rosetta con due fori viti a vista
Rose with two screws holes

art.124 RO MINIMAL LINE



124 RO

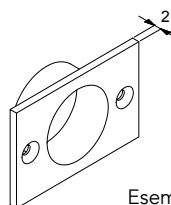
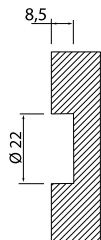
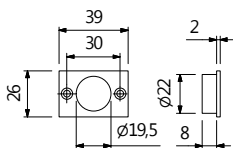

Esempio di applicazione
Mounting example



SISTEMA DI MONTAGGIO STANDARD
STANDARD MOUNTING SYSTEM



Finiture
Finishes

OC	OSC	SNV
€	€	€
•	•	•

ROSETTA MINIMAL LINE

124 RO Rosetta MINIMAL mm.25x39
MINIMAL rose mm.25x39

art.199

RO



RPM System

Vedi pag. 870 - See page 870

Esempio di applicazione
Mounting example



199 RO

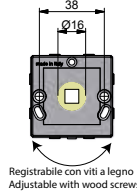
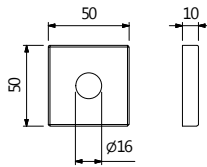

199 ML



Metal

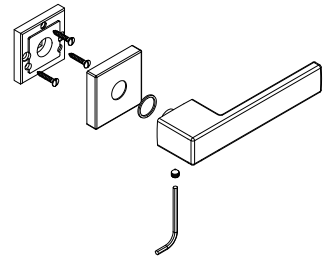

SISTEMA DI MONTAGGIO STANDARD
STANDARD MOUNTING SYSTEM



SISTEMA DI MONTAGGIO A RICHIESTA
ON REQUEST MOUNTING SYSTEM



ROSETTA QUADRATA MM.50X50

199 RO Rosetta coprivite con molla ambidestra e con RPM system
Cover screw rose with bidirectional returning spring and RPM system



199 ML Sottorosetta con molla ambidestra per art. 199 RO
Inside part with bidirectional returning spring for art. 199 RO

Furniture
Finishes

OC

OSC

SNV

€

€

€

•

•

•

€

•

art.200

RO

Esempio di applicazione
Mounting example



200 RO

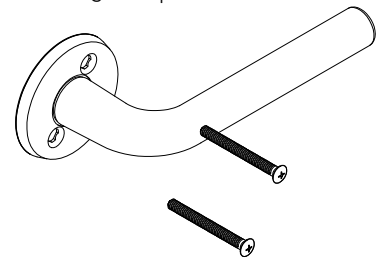
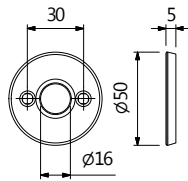

SISTEMA DI MONTAGGIO STANDARD
STANDARD MOUNTING SYSTEM



SISTEMA DI MONTAGGIO A RICHIESTA
ON REQUEST MOUNTING SYSTEM



ROSETTA Ø50

200 RO Rosetta con due fori viti a vista
Rose with two screws holes

art.202

RO

Esempio di applicazione
Mounting example



202 RO

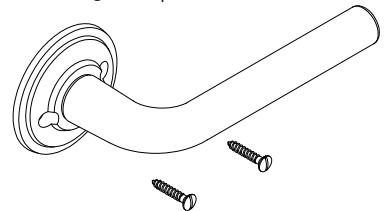
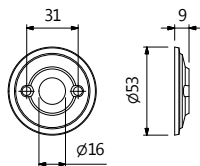

SISTEMA DI MONTAGGIO STANDARD
STANDARD MOUNTING SYSTEM



SISTEMA DI MONTAGGIO A RICHIESTA
ON REQUEST MOUNTING SYSTEM



ROSETTA Ø52

202 RO Rosetta con bordo con due fori viti a vista
Board rose with screw holes

art.203 RO



203 RO

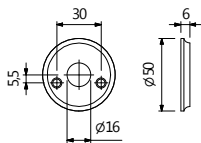

Esempio di applicazione
Mounting example

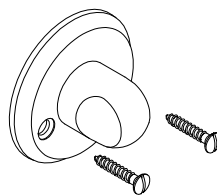

SISTEMA DI MONTAGGIO STANDARD
STANDARD MOUNTING SYSTEM



SISTEMA DI MONTAGGIO A RICHIESTA
ON REQUEST MOUNTING SYSTEM



ROSETTA Ø50

203 RO Rosetta per nottolino WC
Rose for Scandinavian WC lock

art.204 RO



204 RO

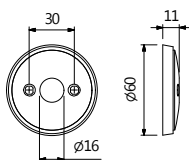

Esempio di applicazione
Mounting example

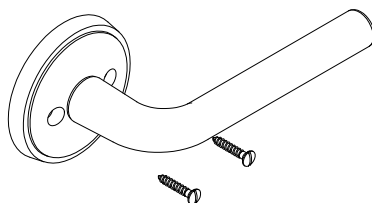

SISTEMA DI MONTAGGIO STANDARD
STANDARD MOUNTING SYSTEM



SISTEMA DI MONTAGGIO A RICHIESTA
ON REQUEST MOUNTING SYSTEM



BOCCHETTA Ø60 YALE

204 RO Rosetta con fori viti a vista
Rose with screw holes

art.206 RO



206 RO

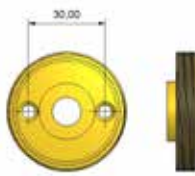
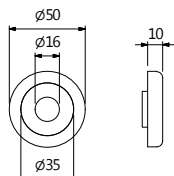

Metal

Esempio di applicazione
Mounting example

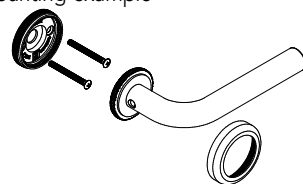

SISTEMA DI MONTAGGIO STANDARD
STANDARD MOUNTING SYSTEM



SISTEMA DI MONTAGGIO A RICHIESTA
ON REQUEST MOUNTING SYSTEM



ROSETTA Ø50

206 RO Rosetta coprivite tipo lusso, adatta ad applicazione molla ambidestra
Lusso type cover screws rose, suitable to insert bidirectional returning spring for scandinavian locks

art.207 RO

Esempio di applicazione
Mounting example



207 RO

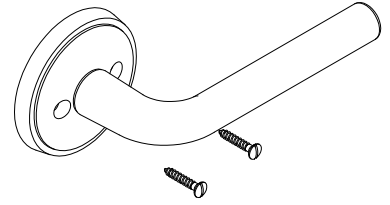
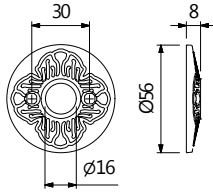

SISTEMA DI MONTAGGIO STANDARD
STANDARD MOUNTING SYSTEM



SISTEMA DI MONTAGGIO A RICHIESTA
ON REQUEST MOUNTING SYSTEM



ROSETTA Ø57

207 RO Rosetta con fori viti a vista
Rose with screw holes

art.382 RO



Esempio di applicazione
Mounting example



382 RO

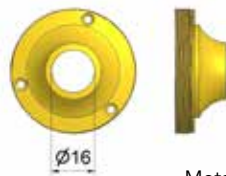
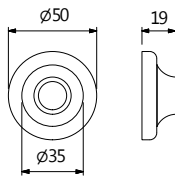

Metal

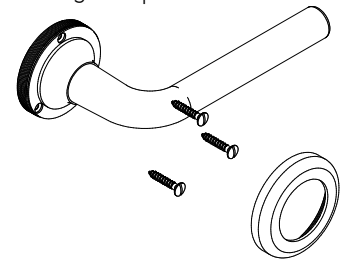

SISTEMA DI MONTAGGIO STANDARD
STANDARD MOUNTING SYSTEM



ROSETTA Ø50 - A CAMPANA

382 RO Rosetta coprivite adatta ad applicazione molla ambidestra
Cover screw rose suitable to insert bidirectional returning spring

art.406 RO

Esempio di applicazione
Mounting example



406 RO

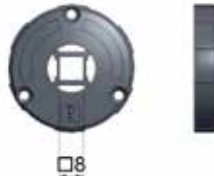
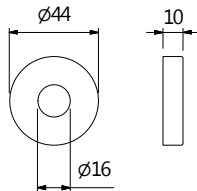

Nylon
PLT RO 406

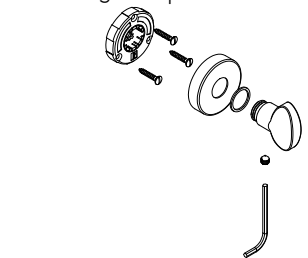

SISTEMA DI MONTAGGIO STANDARD
STANDARD MOUNTING SYSTEM



Finiture
Finishes

LV	BG	OC	OSC
----	----	----	-----

ROSETTA Ø45

406 RO Rosetta coprivite con interno senza molla
Cover screw rose with inside part without returning spring

PLTRO406 Sottorosetta per art.406 RO - senza molla
Inside part for art.406 RO - without returning spring



REGUITTI
Maniglie & Accessori

art.416 RO



416 RO

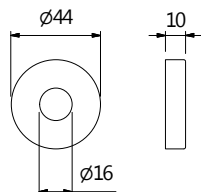

416 ML



Nylon

Esempio di applicazione
Mounting example

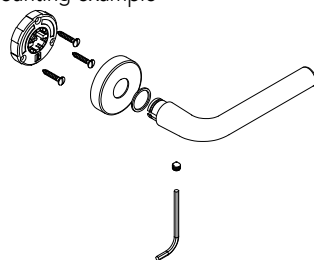

SISTEMA DI MONTAGGIO STANDARD
STANDARD MOUNTING SYSTEM



Finiture Finishes	LV	BG	OC	OSC
	€	€	€	€
	•	•	•	•

ROSETTA Ø45

416 RO Rosetta coprivite con molla ambidestra
Cover screw rose with bidirectional returning spring

416 ML Sottorosetta con molla ambidestra per art. 416RO
Inside part with bidirectional returning spring for art. 416RO

€

•

art.623 RO

Esempio di applicazione
Mounting example



623 RO

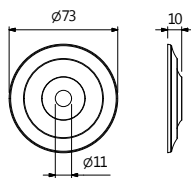

Finiture Finishes	OB	OL	LV	OC	OSC
	€	€	€	€	€
	•	•	•	•	•

ROSETTA Ø73

623 RO Rosetta per supporti corrimano
Rose for handrail brackets

art.628 RO

Esempio di applicazione
Mounting example



628 RO

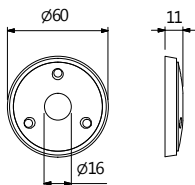

SISTEMA DI MONTAGGIO STANDARD
STANDARD MOUNTING SYSTEM



ROSETTA Ø60

628 RO Rosetta con 3 fori viti a vista per supporti e pomoli fissi
Rose with 3 screws holes for assembling handrail brackets and fix knobs

art.11D RO

Esempio di applicazione
Mounting example



11D RO

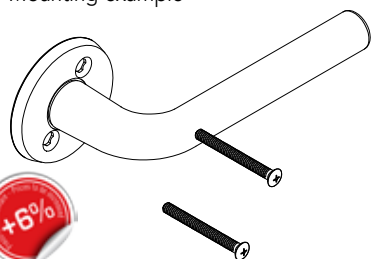
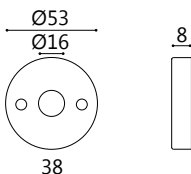

SISTEMA DI MONTAGGIO STANDARD
STANDARD MOUNTING SYSTEM



SISTEMA DI MONTAGGIO A RICHIESTA
ON REQUEST MOUNTING SYSTEM



ROSETTA Ø53

11D RO Rosetta con due fori viti a vista
Rose with two screws holes

art.806 RO

Esempio di applicazione
Mounting example



806 RO

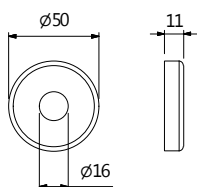

PLTRO806

Nylon

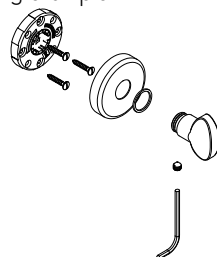

SISTEMA DI MONTAGGIO STANDARD
STANDARD MOUNTING SYSTEM



SISTEMA DI MONTAGGIO A RICHIESTA
ON REQUEST MOUNTING SYSTEM



ROSETTA Ø50

806 RO Rosetta coprivite con interno senza molla
Cover screw rose with inside part without returning spring

PLTRO806 Sottorosetta per art.806 RO - senza molla
Inside part for 806 RO - without returning spring



Finishes
Finiture

	LV	BG	OC	OSC
€	€	€	€	€
•	•	•	•	•
		€		
		•		

art.816 RO



816 RO

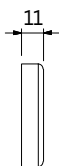
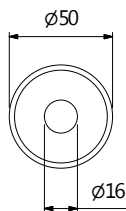

816 ML



Nylon

Esempio di applicazione
Mounting example

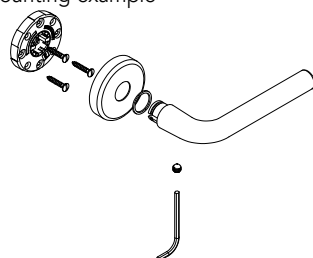

SISTEMA DI MONTAGGIO STANDARD
STANDARD MOUNTING SYSTEM



SISTEMA DI MONTAGGIO A RICHIESTA
ON REQUEST MOUNTING SYSTEM



Finiture
Finishes

LV	BG	OC	OSC
----	----	----	-----

ROSETTA Ø50

816 RO Rosetta coprivite con molla ambidestra
Cover screw rose with bidirectional returning spring

€	€	€	€
•	•	•	•

816 ML Sottorosetta con molla ambidestra per art. 816RO
Inside part with bidirectional returning spring for art. 816RO

€

•

art.916 RO



916 RO

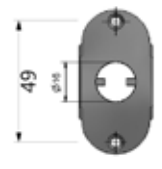
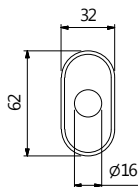

916 ML 2DX**4C



Nylon

Esempio di applicazione
Mounting example

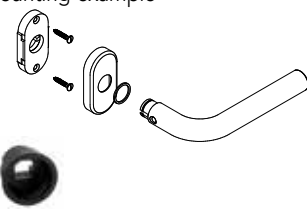

guida/centratore per quadro 8
€ 0,15 (916VM)



SISTEMA DI MONTAGGIO STANDARD
STANDARD MOUNTING SYSTEM



Finiture
Finishes

LV	BG	OC	OSC
----	----	----	-----

ROSETTA COPRIVITE OVALE 62X32

916 RO Rosetta coprivite con molla ambidestra
Cover screw rose with bidirectional returning spring

€	€	€	€
•	•	•	•

916ML2DX**4C Sottorosetta con q.8 con molla ambidestra per art. 916RO-9Q6RO
Inside part with bidirectional returning spring for art. 916RO-9Q6RO

€

•

art.38D RO



38D RO

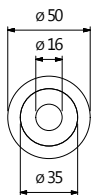

Metal

Esempio di applicazione
Mounting example

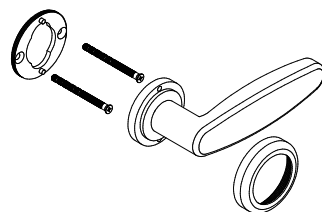

SISTEMA DI MONTAGGIO STANDARD
STANDARD MOUNTING SYSTEM



SISTEMA DI MONTAGGIO A RICHIESTA
ON REQUEST MOUNTING SYSTEM



ROSETTA Ø50

38D RO Rosetta coprivite tipo lusso con base senza bussole, adatta ad applicazioni molla ambidestra
Cover screw rose without fix bushes, suitable to insert bidirectional returning spring



art.56D RO



56D RO

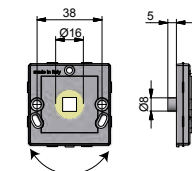
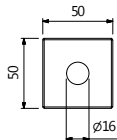

Registrabile con viti a legno
Adjustable with wood screw

56D ML



Metal

Esempio di applicazione
Mounting example

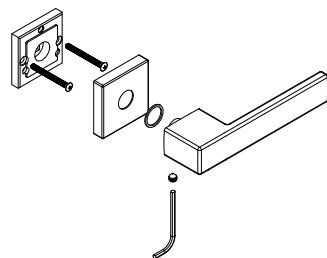

SISTEMA DI MONTAGGIO STANDARD
STANDARD MOUNTING SYSTEM



ROSETTA QUADRATA MM 50X50

56D RO Rosetta coprivite quadrata su base in metallo con bussole e molla
Square Cover screw rose internal metal with bushes, with returning spring

56D ML Sottorosetta con molla ambidestra per ros.56D RO
Inside part with bidirectional returning spring for art.56D RO

Finishes
Finiture

OC

OSC

SNV

€

€

€

•

•

•

€

•



art.60R RO



60R RO

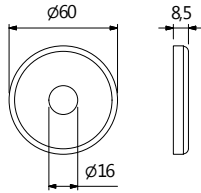

Esempio di applicazione
Mounting example

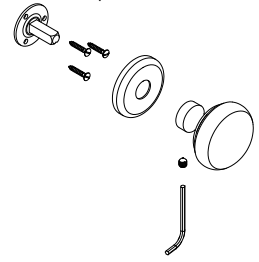

Finiture Finishes	LV	BG	OC	OSC	PVD
	€	€	€	€	€
	•	•	•	•	•

ROSETTA Ø60

60R RO Rosetta copripiastina per montaggio pomoli e battenti
Cover fixing base rose for assembling knobs and door knockers

art.73D RO



73D RO

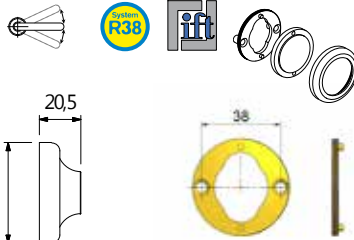
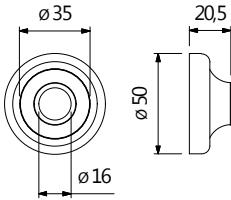

Metal

Esempio di applicazione
Mounting example

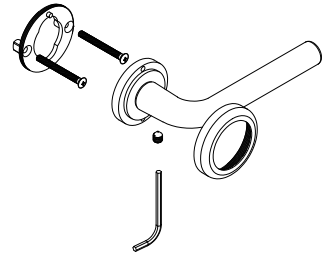

SISTEMA DI MONTAGGIO STANDARD
STANDARD MOUNTING SYSTEM



SISTEMA DI MONTAGGIO A RICHIESTA
ON REQUEST MOUNTING SYSTEM

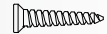

ROSETTA Ø50

73D RO Rosetta coprivite tipo lusso con base senza bussole, adatta ad applicazioni molla ambidestra
Cover screw rose without fix bushes, suitable for bidirectional returning spring

art.73R RO



73R RO

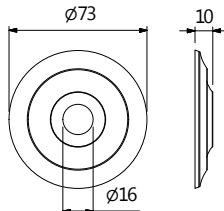

Esempio di applicazione
Mounting example

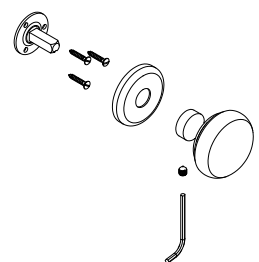

Finiture Finishes	OB	LV	AGV	AN
	€	€	€	€
	•	•	•	•

ROSETTA Ø73

73R RO Rosetta Copripiastina per montaggio pomoli e battenti
Cover fixing base rose for assembling knobs and door knockers



99D RO

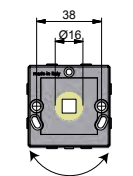
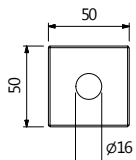

Registabile con viti a legno
Adjustable with wood screw

99D ML

Metal

Esempio di applicazione
Mounting example

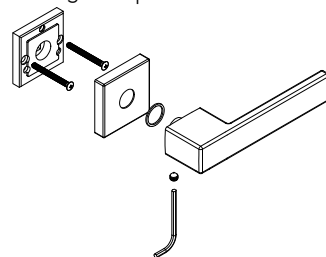

SISTEMA DI MONTAGGIO STANDARD
STANDARD MOUNTING SYSTEM



ROSETTA QUADRATA MM.50X50

99D RO Rosetta coprivite quadrata con 2 bussole sporgenti, molla ambidestra e con RPM system
Cover screw rose with 2 projecting bushes, with bidirectional returning spring and RPM system

Finiture Finishes	OC	OSC	SNV
	€	€	€
	•	•	•

VUOTO

99D ML Sottorosetta con molla ambidestra per art.99D RO
Inside part with bidirectional returning spring for art. 99D RO

€

•



4Q6 RO

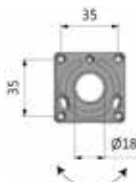
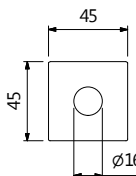

Registabile con viti a legno
Adjustable with wood screw

Nylon

BPLTRO4Q6

Esempio di applicazione
Mounting example

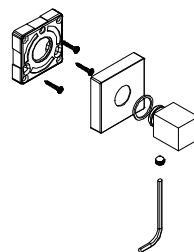

SISTEMA DI MONTAGGIO STANDARD
STANDARD MOUNTING SYSTEM



ROSETTA QUADRATA MM.45X45

4Q6 RO Rosetta coprivite quadrata con interno senza molla
Square cover screw rose with inside part without returning spring

Finiture Finishes	LV	OC	OSC	SNV
	€	€	€	€
	•	•	•	•

PLTRO4Q6 Sottorosetta per art.4Q6 RO - senza molla
Inside part for art. 4Q6 RO - without returning spring

€

•

art.8D6 RO



8D6 RO

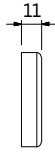
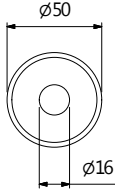

PLT RO 8D6

Nylon

Esempio di applicazione
Mounting example

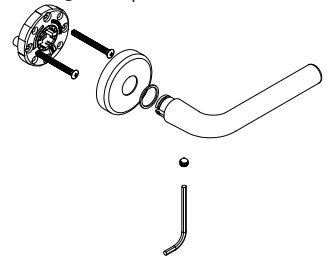

SISTEMA DI MONTAGGIO STANDARD
STANDARD MOUNTING SYSTEM



Finiture
Finishes

ROSETTA Ø50

8D6 RO Rosetta coprivite con interno senza molla e con bussole
Cover screw rose with inside part without returning spring, with bushes

PLTRO8D6 Sottorosetta per art.8D6RO - senza molla
Inside part for 8D6RO - without returning spring

LV

OC

OSC

€

€

€

•

•

•

€

•

art.9Q6 RO



9Q6 RO

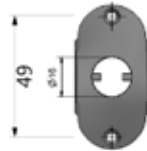
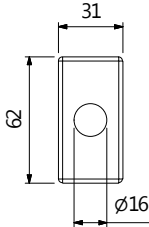

916 ML 2DX**4C

Nylon

Esempio di applicazione
Mounting example

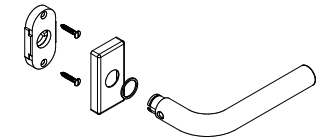

guida/centratore per quadro 8
€ 0,15 (916VM)



SISTEMA DI MONTAGGIO STANDARD
STANDARD MOUNTING SYSTEM



Finiture
Finishes

ROSETTA COPRIVITE RETTANGOLARE 62X31

9Q6 RO Rosetta coprivite con molla ambidestra
Cover screw rose with bidirectional returning spring

916ML2DX**4C Sottorosetta con q.8 con molla ambidestra per art. 916RO-9Q6RO
Inside part with bidirectional returning spring for art. 916RO-9Q6RO

LV

OC

OSC

€

€

€

•

•

•

€

•

art.A52 RO



A52 RO

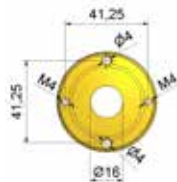
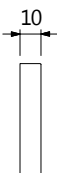
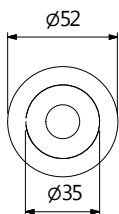

Metal

Esempio di applicazione
Mounting example

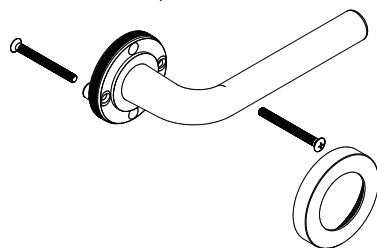

SISTEMA DI MONTAGGIO STANDARD
STANDARD MOUNTING SYSTEM



ROSETTA FOR AUSTRALIA SYSTEM Ø52

A52 RO Rosetta coprivite "passage" per standard Australia adatta ad applicazione molla
"Passage" cover screw rose for Australian standard, suitable to insert returning spring

art.A62 RO



A62 RO

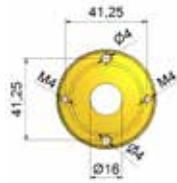
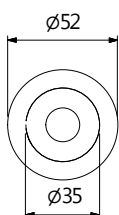

Metal

Esempio di applicazione
Mounting example

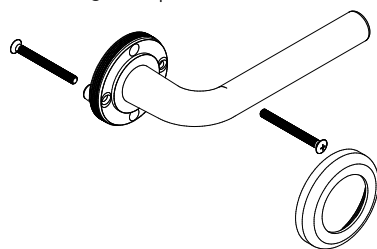

SISTEMA DI MONTAGGIO STANDARD
STANDARD MOUNTING SYSTEM



ROSETTA FOR AUSTRALIA SYSTEM Ø52

A62 RO Rosetta coprivite "passage" per standard Australia adatta ad applicazione molla
"Passage" cover screw rose for Australian standard, suitable to insert returning spring

art.A64 RO



A64 RO

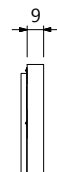
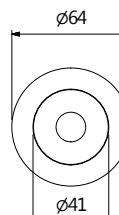

Metal

Esempio di applicazione
Mounting example

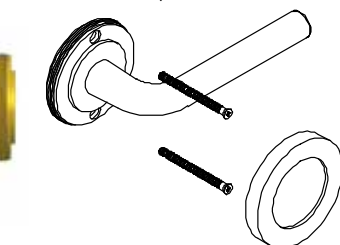

SISTEMA DI MONTAGGIO STANDARD
STANDARD MOUNTING SYSTEM



ROSETTA COPRIVITE PASSAGE Ø64

A64 RO Rosetta "passage" per sistema Nord America
"Passage" rose for North American System

art.A67 RO



Esempio di applicazione
Mounting example



A67 RO

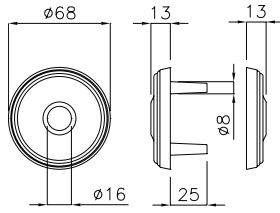

A67RO***P4

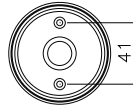

A67RO***F4

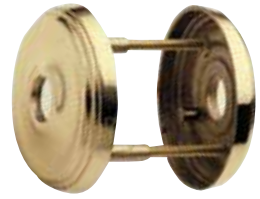

CDA67



SISTEMA DI MONTAGGIO STANDARD
STANDARD MOUNTING SYSTEM



ROSETTA Ø68 FOR NORTH AMERICA SYSTEM

A67 RO Set Rosetta "passage" adatta ad applicazione molla con viti passanti
"Passage" set rose, suitable to insert returning spring with bolt through screws

art.C03 RO

Esempio di applicazione
Mounting example



C03 RO

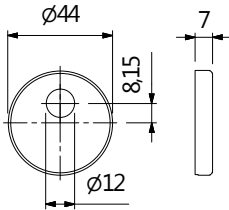

Nylon

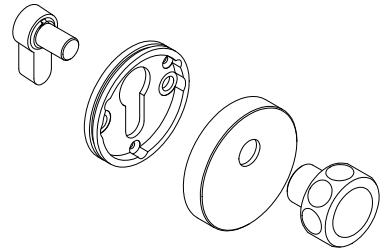

SISTEMA DI MONTAGGIO STANDARD
STANDARD MOUNTING SYSTEM



BOCCHETTA Ø45

C03 RO Bocchetta coprivite con foro asse per cilindretti con codolo
Cover screw rose for cylinders with tang



Finiture Finishes	LV	BG	OC	OSC	AN
€	€	€	€	€	€
	•	•	•	•	•

art.C06 RO

Esempio di applicazione
Mounting example



C06 RO

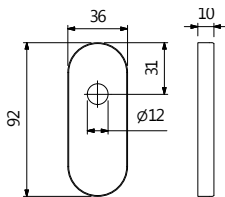

Metal

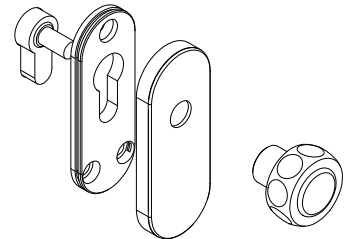

SISTEMA DI MONTAGGIO STANDARD
STANDARD MOUNTING SYSTEM



BOCCHETTA OVALE CON FORO ASSE PER CILINDRO CON CODOLO

C06 RO Bocchetta ovale coprivite con foro asse per cilindro con codolo
Oval cover screw rose for cylinders with tang



Finiture Finishes	LV	OC	OSC
€	€	€	€
	•	•	•

art.C07 RO



C07 RO

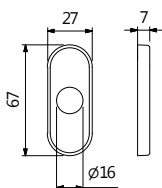

Esempio di applicazione
Mounting example

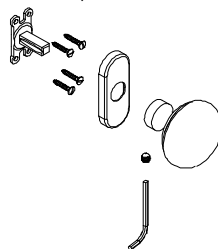

Finiture Finishes	LV	BG	OC	OSC	PVD
	€	€	€	€	€
C07 RO	•	•	•	•	•

ROSETTA OVALE STRETTA

C07 RO Rosetta ovale stretta mm 67x27 copripiastina P4 e P5 per montaggio maniglioni e pomoli
Reduced oval rose mm 67x27 cover fixing base P4 and P5 for assembling knobs and pull handles

art.C08 RO



C08 RO

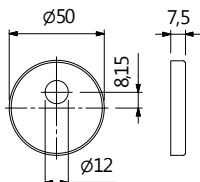

Nylon

Esempio di applicazione
Mounting example

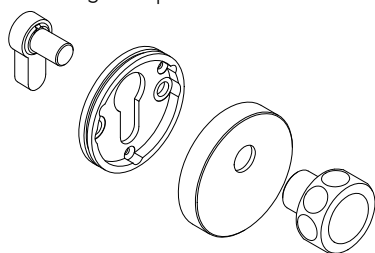

SISTEMA DI MONTAGGIO STANDARD
STANDARD MOUNTING SYSTEM



Finiture Finishes	LV	BG	OC	OSC
	€	€	€	€
C08 RO	•	•	•	•

BOCCHETTA Ø50

C08 RO Bocchetta con foro asse per cilindri con codolo
Cover screw rose for cylinders with tang

art.C09 RO



C09 RO

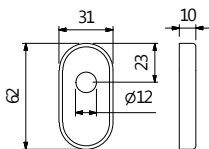

Nylon

Esempio di applicazione
Mounting example

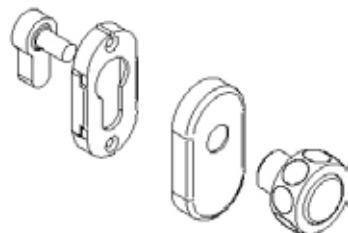

SISTEMA DI MONTAGGIO STANDARD
STANDARD MOUNTING SYSTEM



Finiture Finishes	AN	LV	BG	OC	OSC
	€	€	€	€	€
C09 RO	•	•	•	•	•

BOCCHETTA COPRIVITE OVALE MM 62X32

C09 RO Bocchetta coprivite con foro asse per cilindretti con tang 5,03
Cover screw rose for cylinders with tang 5,03

art.C15 RO



C15 RO

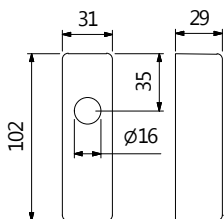

disponibile l'abbinamento per ogni maniglia
available for every lever handle

calcolo prezzi rispetto ai dk standard...DKC15, extra prezzo rispetto a...DK015
pricing calculation compare to our standard dk...DKC15, extra price from ...DK015

ROSETTA SPECIALE PER MOVIMENTO DK MM 29X102X31

C15 RO Rosetta per movimenti DK con cilindro e chiave (M7)
Rose for DK mechanism with cylinder and key (M7)

Esempio di applicazione
Mounting example

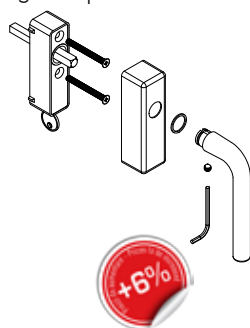

Finiture Finishes	LV	BG	OC	OSC
	€	€	€	€
	•	•	•	•

art.C24 RO



C24 RO

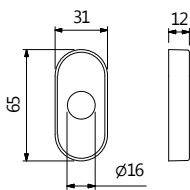

Esempio di applicazione
Mounting example

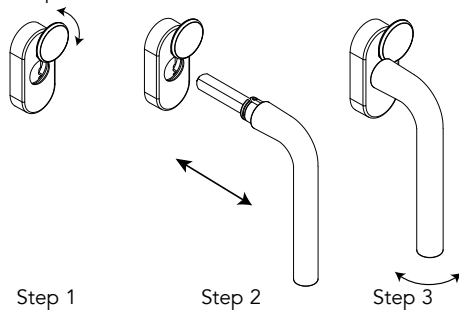

SISTEMA DI MONTAGGIO STANDARD
STANDARD MOUNTING SYSTEM



Finiture Finishes	LV	BG	OC	OSC
	€	€	€	€
	•	•	•	•

ROSETTA CIECA PER IMPUGNATURA ESTRAIBILE

C24 RO Rosetta per impugnature DK estraibili
Rose for removable DK lever

art.C55 RO



C55 RO

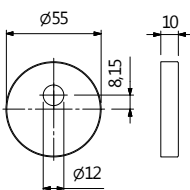

Metal

Esempio di applicazione
Mounting example

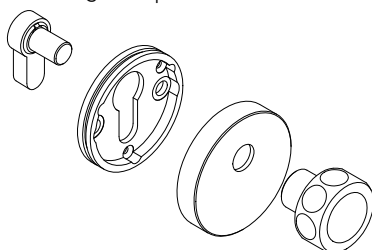

SISTEMA DI MONTAGGIO STANDARD
STANDARD MOUNTING SYSTEM



SISTEMA DI MONTAGGIO A RICHIESTA
ON REQUEST MOUNTING SYSTEM



Finiture Finishes	LV	BG	OC	OSC
	€	€	€	€
	•	•	•	•

BOCCHETTA Ø55 SU BASE IN OTTONE

C55 RO Bocchetta con foro asse per cilindro con codolo
Cover screw rose for cylinders with tang

art.C62 RO



C62 RO

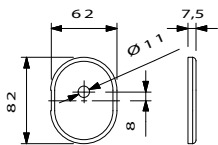

Nylon

Esempio di applicazione
Mounting example

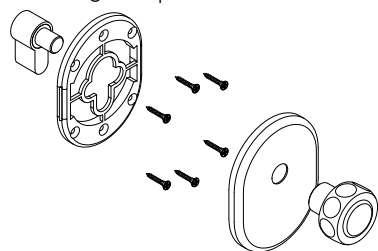

SISTEMA DI MONTAGGIO STANDARD
STANDARD MOUNTING SYSTEM



Finiture Finishes	LV	OS BG	OC	OSC	PVD	AGV	AN
€	€	€	€	€	€	€	€
	•	•	•	•	•	•	•

ROSETTA CON FORO ASSE PER CILINDRO

C62 RO Rosetta con foro asse per cilindretti con codolo
Rose for cylinders with tag

art.C67 RO



C67 RO

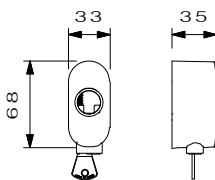

7M

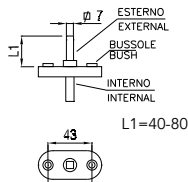

Esempio di applicazione
Mounting example

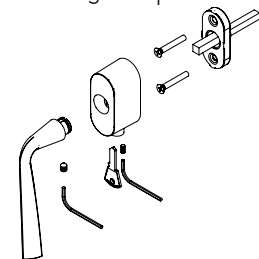

B780M1845542T L1 Q.7 X MM.80
B740M1845542T L1 Q.7X MM.40

Movimento per rosetta C67 con cilindro chiave
Mechanism for rose C67 with cylinder and key

disponibile l'abbinamento per ogni maniglia
available for every lever handle

calcolo prezzi rispetto ai dk standard...DKC67, extra prezzo rispetto a...DK015
pricing calculation compare to our standard dk...DKC67, extra price from ...DK015

Finiture Finishes	AN	LV BG	OC	OSC	AGV
€	€	€	€	€	€
	•	•	•	•	•

C67 RO Rosetta con cilindro e chiave per movimenti DK 7M
Rose with cylinder and key for mechanism DK 7M

art.C70 RO



C70 RO

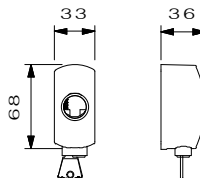

7M

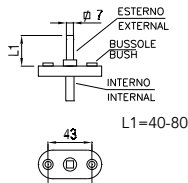

Esempio di applicazione
Mounting example

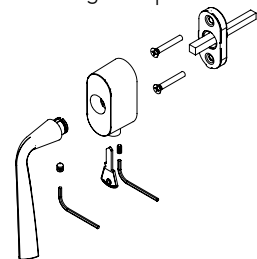

B780M1845542T L1 Q.7 X MM.80
B740M1845542T L1 Q.7X MM.40

Movimento per rosetta C70 con cilindro chiave
Mechanism for rose C70 with cylinder and key

disponibile l'abbinamento per ogni maniglia
available for every lever handle

calcolo prezzi rispetto ai dk standard...DKC70, extra prezzo rispetto a...DK015
pricing calculation compare to our standard dk...DKC70, extra price from ...DK015

Finiture Finishes	LV BG	OC	OSC	SNV
1€	€	€	€	€
	•	•	•	•

C70 RO Rosetta con cilindro e chiave per movimenti DK 7M
Rose with cylinder and key for mechanism DK 7M

art.D05 RO



D05 RO

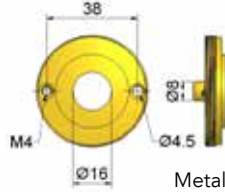
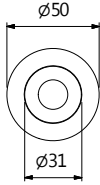

Esempio di applicazione
Mounting example

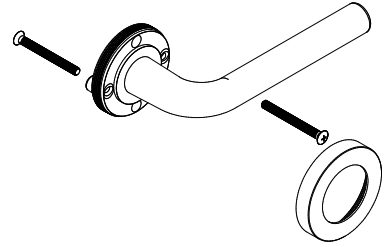

SISTEMA DI MONTAGGIO STANDARD
STANDARD MOUNTING SYSTEM



ROSETTA Ø50

D05 RO Rosetta coprivite tipo lusso con 2 bussole sporgenti, adatta ad applicazione molla
Cover screw rose with projecting bushes, suitable to insert returning spring

art.D06 RO



D06 RO

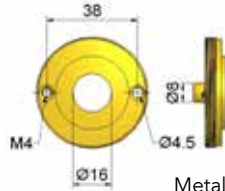
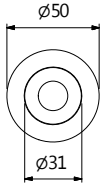

Esempio di applicazione
Mounting example

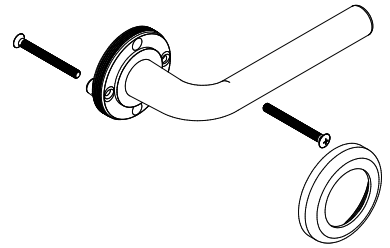

SISTEMA DI MONTAGGIO STANDARD
STANDARD MOUNTING SYSTEM



ROSETTA Ø50

D06 RO Rosetta coprivite tipo lusso con 2 bussole sporgenti, adatta ad applicazione molla
Cover screw rose with 2 projecting bushes, suitable to apply returning spring

art.D08 RO



D08 RO

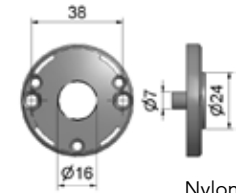
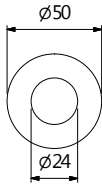

Esempio di applicazione
Mounting example

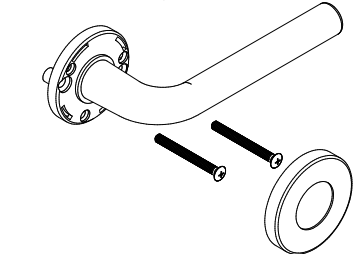

SISTEMA DI MONTAGGIO STANDARD
STANDARD MOUNTING SYSTEM



SISTEMA DI MONTAGGIO A RICHIESTA
ON REQUEST MOUNTING SYSTEM



ROSETTA Ø50

D08 RO Rosetta coprivite su base in plastica con bussole adatta ad applicazione molla
Cover screw rose with bushes, suitable to insert returning spring

art.D11 RO



D11 RO

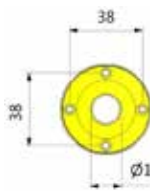
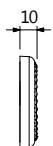
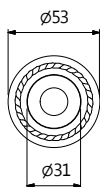

Metal

Esempio di applicazione
Mounting example

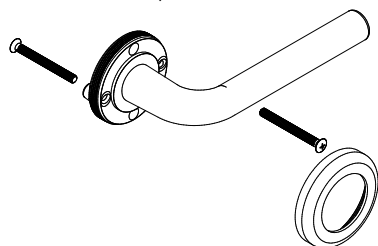

SISTEMA DI MONTAGGIO STANDARD
STANDARD MOUNTING SYSTEM



ROSETTA ELEMENTIA Ø53

D11 RO Rosetta coprivate quadrata con 2 bussole sporgenti
Square cover screw rose with 2 projecting bushes



art.D16 RO



D16 RO

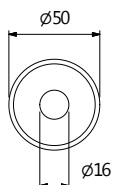

D16 ML

Nylon

Esempio di applicazione
Mounting example

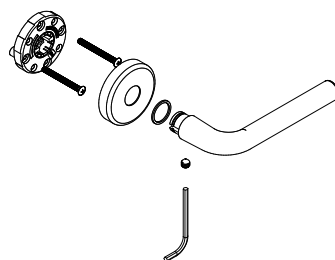

SISTEMA DI MONTAGGIO STANDARD
STANDARD MOUNTING SYSTEM



ROSETTA Ø50

D16 RO Rosetta coprivate con molla ambidestra e con bussole
Cover screw rose with bidirectional returning spring with bushes



D16 ML Sottorosetta con molla ambidestra per art. D16RO
Inside part with bidirectional returning spring for art.D16RO

Finiture
Finishes

LV

OC

OSC

SNV

€

€

€

€

•

•

•

•

€

•

art.D38 RO



D38 RO

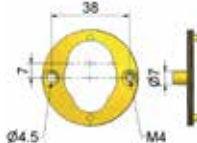
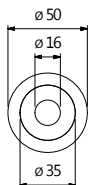

Metal

Esempio di applicazione
Mounting example

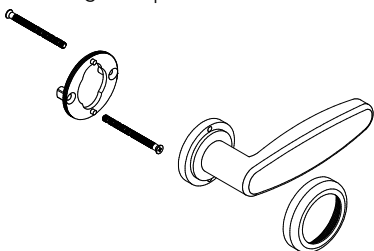

SISTEMA DI MONTAGGIO STANDARD
STANDARD MOUNTING SYSTEM



ROSETTA Ø50

D38 RO Rosetta coprivite tipo lusso su base con 2 bussole fisse sporgenti, adatta ad applicazione molla ambidestra
Cover screw rose with projecting fix bushes, suitable for insert bidirectional returning spring

art.D73 RO



D73 RO

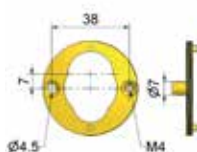
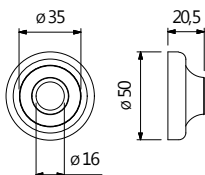

Metal

Esempio di applicazione
Mounting example

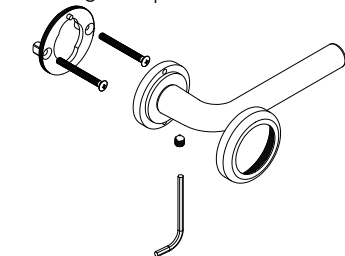

SISTEMA DI MONTAGGIO STANDARD
STANDARD MOUNTING SYSTEM



ROSETTA Ø50

D73 RO Rosetta coprivite tipo lusso con base con 2 bussole fisse sporgenti, adatta ad applicazione molla ambidestra
Cover screw rose with projecting fix bushes, suitable for bidirectional returning spring

art.D98 RO



D98 RO

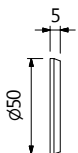
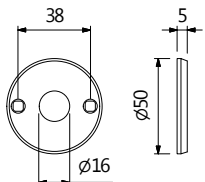

Esempio di applicazione
Mounting example

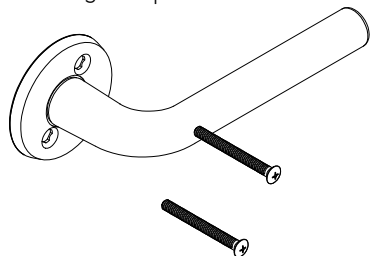

SISTEMA DI MONTAGGIO STANDARD
STANDARD MOUNTING SYSTEM



SISTEMA DI MONTAGGIO A RICHIESTA
ON REQUEST MOUNTING SYSTEM



ROSETTA Ø50

D98 RO Rosetta con fori viti quadri per applicazione bussole quadre
Rose with square screw holes for square bushes

art.F24 RO



minimal line



F24 RO

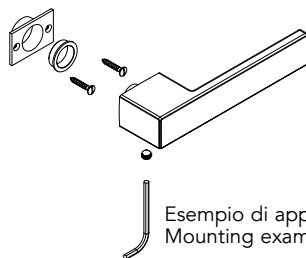
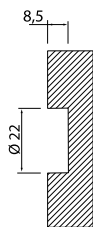
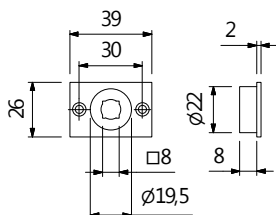

Esempio di applicazione
Mounting example



SISTEMA DI MONTAGGIO STANDARD
STANDARD MOUNTING SYSTEM



Finiture
Finishes

OC

OSC

SNV

ROSETTA MINIMAL LINE

F24 RO Rosetta MINIMAL LINE per maniglie fisse, non girevoli mm.25x39 con foro quadro 8
MINIMAL rose mm.25x39 with square mm.8 hole for fixed levers

€	€	€
•	•	•

art.F56 RO



F56 RO

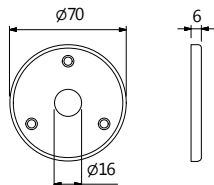

Esempio di applicazione
Mounting example

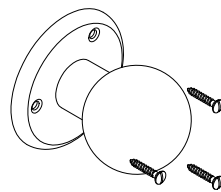

SISTEMA DI MONTAGGIO STANDARD
STANDARD MOUNTING SYSTEM



ROSETTA Ø70

F56 RO Rosetta con 3 fori viti a vista per pomoli fissi
Rose with 3 screws holes for assembling fix knobs

art.F62 RO



F62 RO

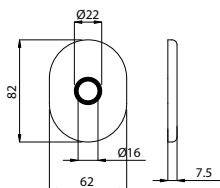

Nylon

Esempio di applicazione
Mounting example

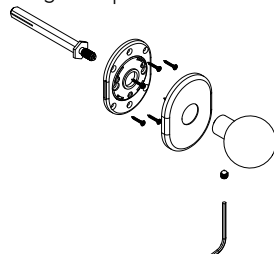

SISTEMA DI MONTAGGIO STANDARD
STANDARD MOUNTING SYSTEM



SISTEMA DI MONTAGGIO A RICHIESTA
ON REQUEST MOUNTING SYSTEM



Finiture
Finishes

LV

BG

OC
OSC

ROSETTA PER PORTE BLINDATE

F62 RO Rosetta con sede esagonale per connessione pomoli fissi
Cover screws rose with exagon for fixed knobs

€	€	€
•	•	•

art.CDJ08 RO

FLAT LINE



CD J08

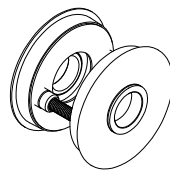
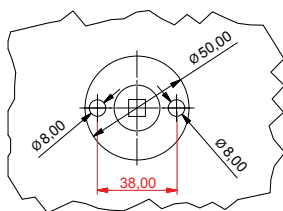
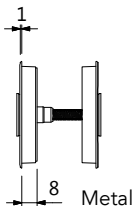
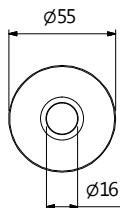

Esempio di applicazione
Mounting example



SISTEMA DI MONTAGGIO STANDARD
STANDARD MOUNTING SYSTEM



Finiture
Finishes

ZCR
ZSC

SNV

ROSETTE FLAT LINE TONDE

CDJ08 Set 2 rosette flat line tonde
Set 2 round flat roses

€	€
•	•

art.N08 RO



N08 RO

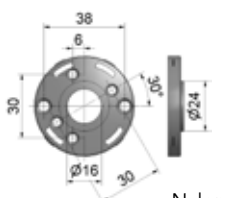
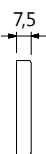
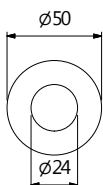

Esempio di applicazione
Mounting example

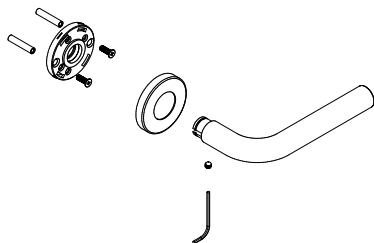

SISTEMA DI MONTAGGIO STANDARD
STANDARD MOUNTING SYSTEM



SISTEMA DI MONTAGGIO A RICHIESTA
ON REQUEST MOUNTING SYSTEM



ROSETTA Ø50

N08 RO Rosetta coprivite con interno per montaggio senza molla su base in plastica per montaggio senza molla
Cover screw rose without returning spring

art.N16 RO



N16 RO

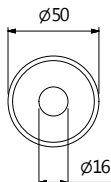

Esempio di applicazione
Mounting example

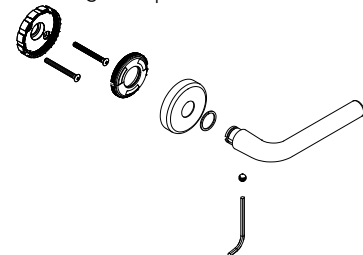

SISTEMA DI MONTAGGIO STANDARD
STANDARD MOUNTING SYSTEM



ROSETTA Ø50

N16 RO Rosetta coprivite con molla ambidestra
Cover screw rose with bidirectional returning spring for scandinavian locks

art.P08 RO



P08 RO

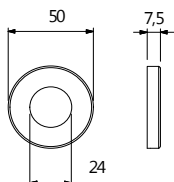

Nylon

Esempio di applicazione
Mounting example

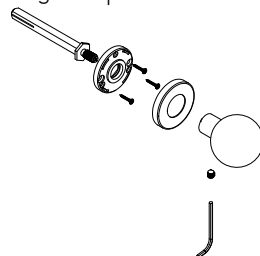

SISTEMA DI MONTAGGIO STANDARD
STANDARD MOUNTING SYSTEM



SISTEMA DI MONTAGGIO A RICHIESTA
ON REQUEST MOUNTING SYSTEM



ROSETTA Ø50

P08 RO Rosetta con sede esagonale per connessione pomoli fissi
Rose with hexagonal seat for fixed knobs

art.P52 RO



P52 RO

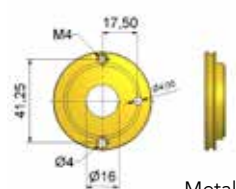
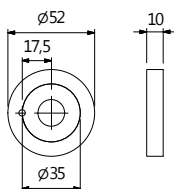

Metal

Esempio di applicazione
Mounting example

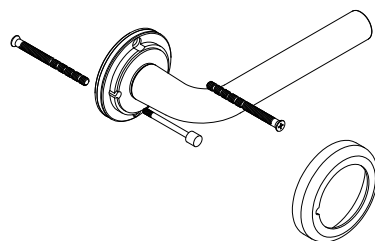

SISTEMA DI MONTAGGIO STANDARD
STANDARD MOUNTING SYSTEM



ROSETTA FOR AUSTRALIA SYSTEM Ø52

P52 RO Rosetta coprivite "privacy" per standard Australia adatta ad applicazione molla, completa di piolino / Rosetta adatta al sistema "privacy" E con distanza tra centro quadro e pomolino mm 17,5
"Privacy" cover screw rose for Australian standard, suitable to insert returning spring, included pin Rose suitable to "privacy" system E with distance mm 17,5 between square centre and small knob

art.P62 RO



P62 RO

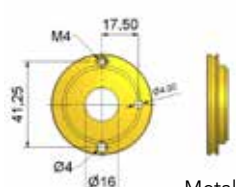
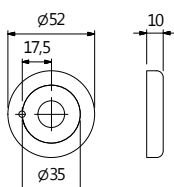

Metal

Esempio di applicazione
Mounting example

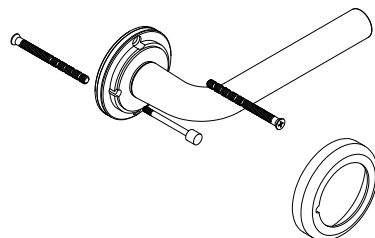

SISTEMA DI MONTAGGIO STANDARD
STANDARD MOUNTING SYSTEM



ROSETTA FOR AUSTRALIA SYSTEM Ø52

P62 RO Rosetta coprivite "privacy" per standard Australia adatta ad applicazione molla, completa di piolino / Rosetta adatta al sistema "privacy" "E" con distanza tra centro quadro e pomolino mm 17,5
"Privacy" cover screw rose for Australian standard, suitable to insert returning spring, included pin / Rose suitable to "privacy" system "E" with distance mm 17,5 between square centre and small

art.P64 RO



P64 RO

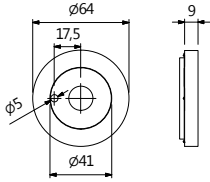

Metal

Esempio di applicazione
Mounting example

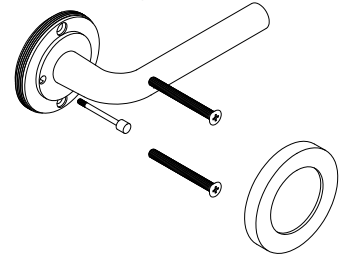

SISTEMA DI MONTAGGIO STANDARD
STANDARD MOUNTING SYSTEM



ROSETTA COPRIVITE PRIVACY Ø64

P64 RO Rosetta "privacy" per sistema Nord America
"Privacy" rose for North America System

art.P67 RO



P67 RO

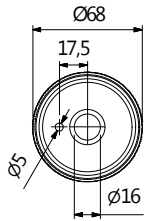

P67RO***P4

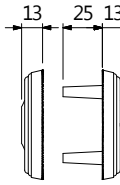

P67RO***F4

Esempio di applicazione
Mounting example

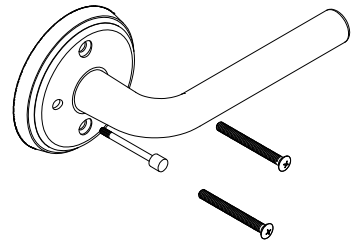

SISTEMA DI MONTAGGIO STANDARD
STANDARD MOUNTING SYSTEM



ROSETTA Ø68 CON PIOLINO PRIVACY / WITH PRIVACY PIN

P67 RO Set Rosetta "privacy" adatta ad applicazione molla con viti passanti
"Privacy" set rose, suitable to insert returning spring with bolt through screws

art.Q02 RO



Q02 RO

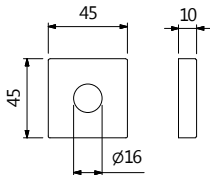

Esempio di applicazione
Mounting example

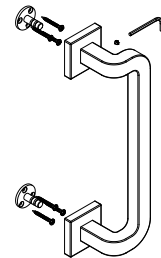

ROSETTA QUADRATA MM.45X45

Q02 RO Rosetta copripiastina per montaggio maniglioni
Cover fixing base rose for assembling pull handles



Finiture
Finishes

LV

OC

OSC

SNV

€

€

€

€

•

•

•

•

art.Q05 RO



Esempio di applicazione
Mounting example



Q05 RO

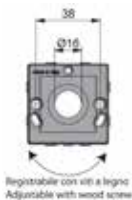
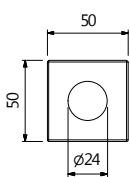

Metal

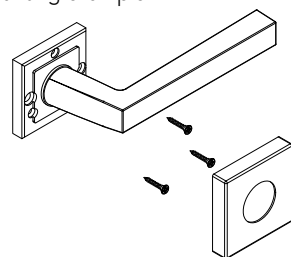

SISTEMA DI MONTAGGIO STANDARD
STANDARD MOUNTING SYSTEM



SISTEMA DI MONTAGGIO A RICHIESTA
ON REQUEST MOUNTING SYSTEM



ROSETTA QUADRATA TIPO LUSO

Q05 RO Rosetta coprivate quadrata su base in metallo adatta ad applicazione molla
Square Cover screw rose, internal metal, suitable to insert returning spring



art.Q08 RO



Esempio di applicazione
Mounting example



Q08 RO

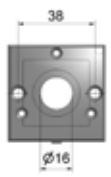
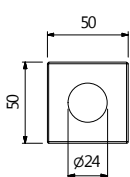

Nylon

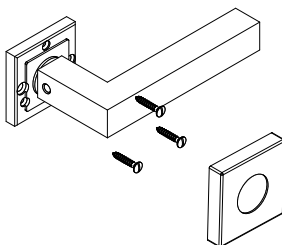

SISTEMA DI MONTAGGIO STANDARD
STANDARD MOUNTING SYSTEM



SISTEMA DI MONTAGGIO A RICHIESTA
ON REQUEST MOUNTING SYSTEM



ROSETTA QUADRATA MM 50X50

Q08 RO Rosetta coprivate quadrata su base in plastica adatta ad applicazione molla
Square Cover screw rose, suitable to insert returning spring

art.Q09 RO



Esempio di applicazione
Mounting example



Q09 RO

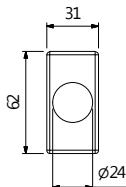

Nylon

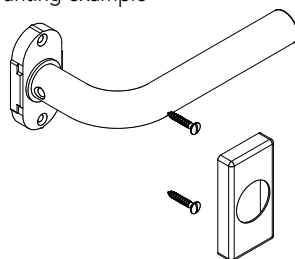

SISTEMA DI MONTAGGIO STANDARD
STANDARD MOUNTING SYSTEM



ROSETTA COPRIVATE MM 62X31

Q09 RO Rosetta coprivate mm 62x31 su base in plastica adatta ad applicazione molla
Square Cover screw rose, suitable to insert returning spring

art.Q15 RO



Esempio di applicazione
Mounting example

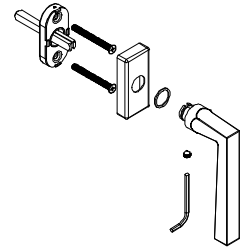
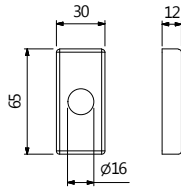

Q15 RO



Finiture
Finishes

LV	OC	OSC	SNV
----	----	-----	-----

ROSETTA RETTANGOLARE PER MOVIMENTO DK MM 65X31

Q15 RO Rosetta rettangolare per movimento DK M1
Rectangular rose for M1 DK mechanism

€	€	€	€
•	•	•	•

art.Q22 RO



minimal line

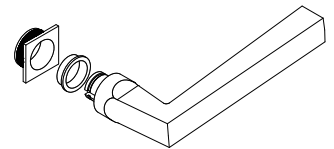
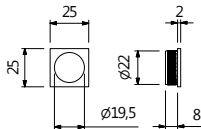

Q22 RO

Esempio di applicazione
Mounting example



SISTEMA DI MONTAGGIO STANDARD
STANDARD MOUNTING SYSTEM



COLLA / GLUE



Finiture
Finishes

OC	OSC	SNV	PVD INOX
----	-----	-----	-------------

ROSETTA MINIMAL LINE

Q22 RO Rosetta MINIMAL quadra mm.25x25
MINIMAL square rose mm.25x25

€	€	€	€
•	•	•	•

art.Q50 RO

Esempio di applicazione
Mounting example

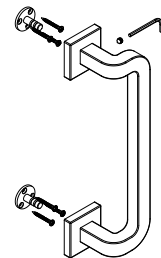
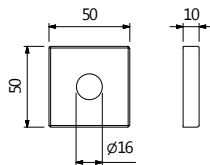

Q50 RO



Finiture
Finishes

LV	OC OSC
----	-----------

ROSETTA QUADRATA MM 50X50

Q50 RO Rosetta copripiastrina per montaggio maniglie
Cover fixing base rose for assembling pull handles

€	€
•	•

art.Q46 RO



Q46 RO

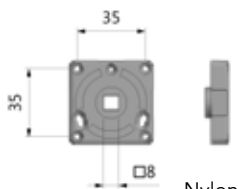
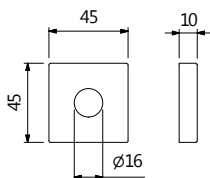

Regolabile con viti a legno
Adjustable with wood screw

Q46ML

Esempio di applicazione
Mounting example

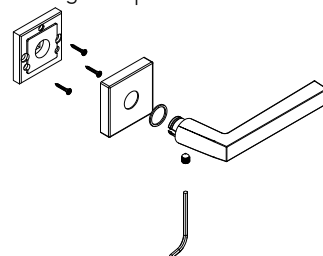

SISTEMA DI MONTAGGIO STANDARD
STANDARD MOUNTING SYSTEM



ROSETTA QUADRATA MM 50X50

Q46 RO Rosetta coprivite quadrata su base in plastica adatta ad applicazione molla
Square Cover screw rose, suitable to insert returning spring

Q46 ML Sottorosetta con molla ambidestra per art.Q46RO
Inside part with bidirectional returning spring for art.Q46RO

Finiture
Finishes

OC

OSC

SNV

€

€

€

•

•

•



€

•

art.Q56 RO



Q56 RO

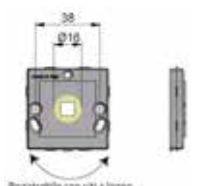
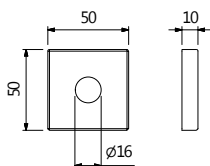

Regolabile con viti a legno
Adjustable with wood screw

Q56 ML

Esempio di applicazione
Mounting example

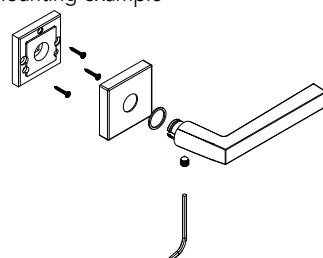

SISTEMA DI MONTAGGIO STANDARD
STANDARD MOUNTING SYSTEM



SISTEMA DI MONTAGGIO A RICHIESTA
ON REQUEST MOUNTING SYSTEM



ROSETTA QUADRATA MM 50X50

Q56 RO Rosetta coprivite quadrata su base in metallo con molla
Square Cover screw rose internal metal, with returning spring

Q56 ML Sottorosetta con molla ambidestra per art.Q56RO
Inside part with bidirectional returning spring for art.Q56RO

Finiture
Finishes

OC

OSC

SNV

€

€

€

•

•

•



€

•

art. Q75 RO



AQ75 RO

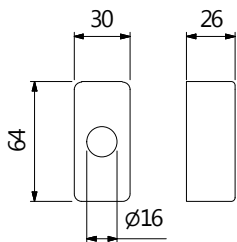

Esempio di applicazione
Mounting example

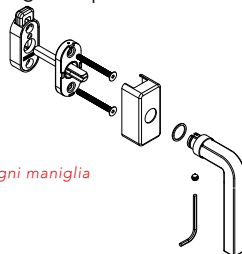

disponibile l'abbinamento per ogni maniglia
available for every lever handle

CALCOLO PREZZI /PRICING CALCULATION
...DKQ75 Extra prezzo rispetto a ...DKQ15
...DKQ75 Extra price from ...DKQ15



ROSETTA CON PULSANTE DI SICUREZZA PER DK

AQ75 RO Rosetta DK con pulsante senza movimento
Rose for DK with button without moving

	LV	OC OSC	SNV
€	€	€	€
	•	•	•

art. Q86 RO



Q86 RO

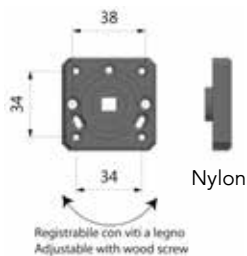
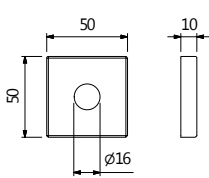

Q86 ML

Esempio di applicazione
Mounting example

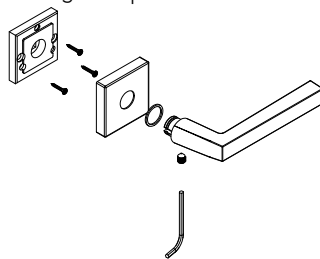

Registabile con viti a legno
Adjustable with wood screw



SISTEMA DI MONTAGGIO STANDARD
STANDARD MOUNTING SYSTEM



SISTEMA DI MONTAGGIO A RICHIESTA
ON REQUEST MOUNTING SYSTEM



ROSETTA QUADRATA MM 50X50

Q86 RO Rosetta coprivite quadrata su base in plastica adatta ad applicazione molla
Square Cover screw rose, suitable to insert returning spring



Q86 ML Sottorosetta con molla ambidestra per art. Q86RO
Inside part with Bidirectional returning spring for art. Q86RO

Finiture Finishes	OC	OSC	SNV
€	€	€	€
	•	•	•
		€	
		•	

art.R37 RO



R37 RO

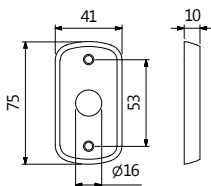

Esempio di applicazione
Mounting example

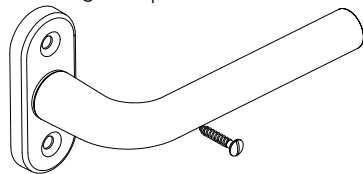

SISTEMA DI MONTAGGIO STANDARD
STANDARD MOUNTING SYSTEM



ROSETTA MM 41X74

R37 RO Rosetta adatta ad applicazioni molla
Rose suitable to insert returning spring

art.R40 RO



R40 RO

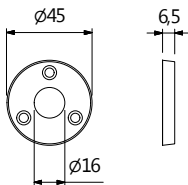

Esempio di applicazione
Mounting example

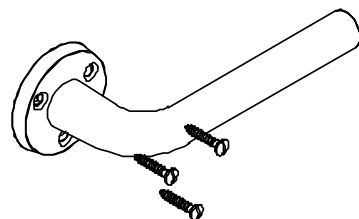

SISTEMA DI MONTAGGIO STANDARD
STANDARD MOUNTING SYSTEM



ROSETTA Ø45

R40 RO Rosetta con 3 fori viti a vista
Rose with 3 screws holes

art.R46 RO



R46 RO

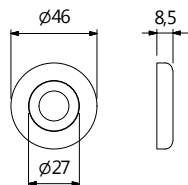

Metal

Esempio di applicazione
Mounting example



SISTEMA DI MONTAGGIO STANDARD
STANDARD MOUNTING SYSTEM



Finiture
Finishes

LV	OS	BG	OC	OSC	PVD
€	€	€	€	€	€
•	•	•	•	•	•

ROSETTA Ø46

R46 RO Rosetta coprivite Ø46 tipo lusso per montaggio su maniglioni
Lusso cover screw rose Ø46 for pull handles

art.R50 RO



R50 RO

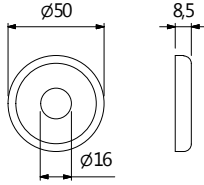

Esempio di applicazione
Mounting example

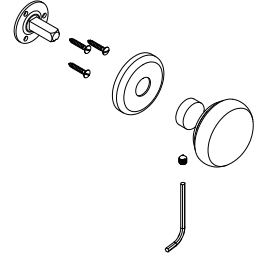

Finiture Finishes	LV BG	OC OSC	AN
	€		
	3,08	3,62	3,62

ROSETTA Ø50

R50 RO Rosetta copripiastina per montaggio pomoli
Cover fixing base rose for assembling knobs

art.R52 RO



R52 RO

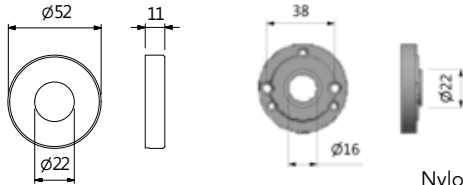

Esempio di applicazione
Mounting example

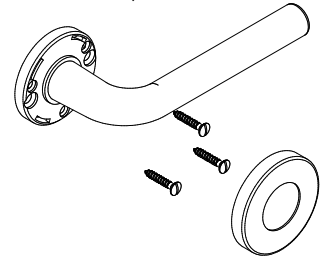

Nylon



SISTEMA DI MONTAGGIO STANDARD
STANDARD MOUNTING SYSTEM



SISTEMA DI MONTAGGIO A RICHIESTA
ON REQUEST MOUNTING SYSTEM



ROSETTA Ø52

R52 RO Rosetta coprivite
Cover screw rose

art.R56 RO



R56 RO

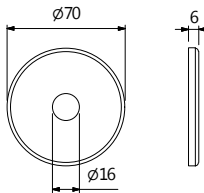

Esempio di applicazione
Mounting example

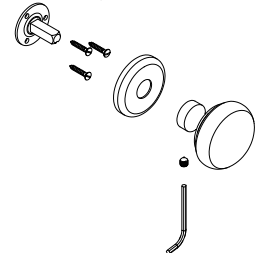

Finiture Finishes	LV	BG	OC OSC
	€		
	•	•	•

ROSETTA Ø70

R56 RO Rosetta Copripiastina per montaggio pomoli
Cover fixing base rose for assembling knobs

art.R71 RO



R71 RO

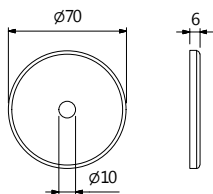

Esempio di applicazione
Mounting example

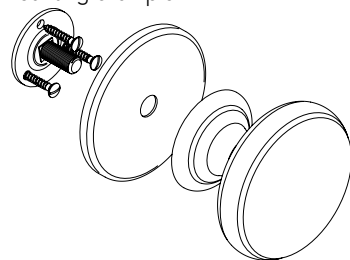

Finiture
Finishes

LV
BG

OC
OSC

PVD

ROSETTA OPZIONALE Ø 70 / OPTIONAL ROSE Ø 70

R71 RO Rosetta aggiuntiva per l'allargamento del diametro di base a mm 70
Rose adapter for improving diameter on base to 70 mm

€

€

€

•

•

•

art.R73 RO



Esempio di applicazione
Mounting example

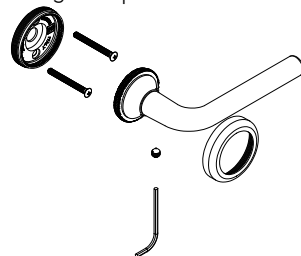

R73 RO

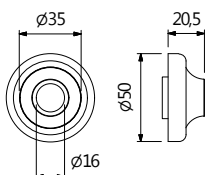

Metal



SISTEMA DI MONTAGGIO STANDARD
STANDARD MOUNTING SYSTEM



SISTEMA DI MONTAGGIO A RICHIESTA
ON REQUEST MOUNTING SYSTEM



ROSETTA Ø50

R73 RO Rosetta coprivite tipo lusso, con base in ottone, adatta ad applicazione molla
Lusso type cover screws rose, suitable to insert returning spring for scandinavian lock

art.R80 RO



R80 RO

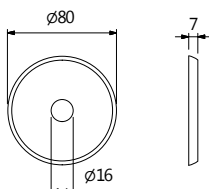

Esempio di applicazione
Mounting example

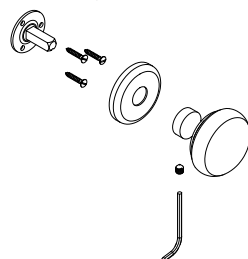

VERSIONI / VERSIONS

ROSETTA Ø80

R80 RO Rosetta copripiastina per montaggio pomoli fissi
Cover fixing base rose for fixed knobs



Finiture
Finishes

LV
BG

OC
OSC

€

•

•

art.S08 RO



S08 RO

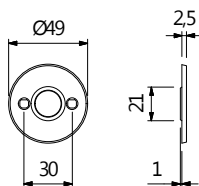

Esempio di applicazione
Mounting example

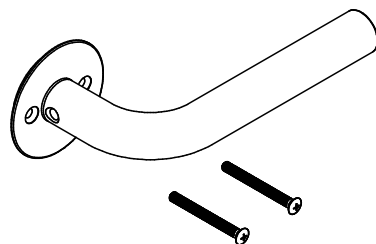

SISTEMA DI MONTAGGIO STANDARD
STANDARD MOUNTING SYSTEM



ROSETTA FLAT Ø50

S08 RO Rosetta FLAT con 2 fori viti a vista
FLAT rose with 2 screws holes

art.T33 RO



T33 RO

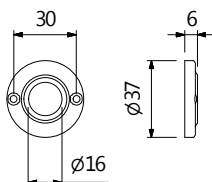

Esempio di applicazione
Mounting example

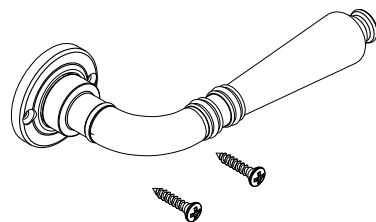

SISTEMA DI MONTAGGIO STANDARD
STANDARD MOUNTING SYSTEM



ROSETTA Ø37

T33 RO Rosetta con 2 fori viti a vista
Rose with 2 screws holes

art.T36 RO



T36 RO

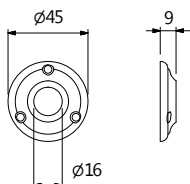

Esempio di applicazione
Mounting example

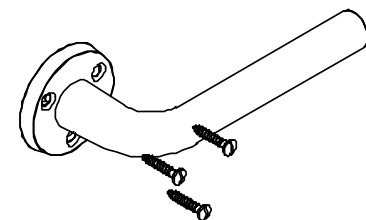

SISTEMA DI MONTAGGIO STANDARD
STANDARD MOUNTING SYSTEM



ROSETTA Ø45

T36 RO Rosetta con 3 fori viti a vista
Rose with 3 screws holes

art.CQ6 RO



CQ6 RO

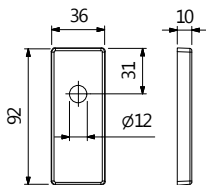

Metal

Esempio di applicazione
Mounting example

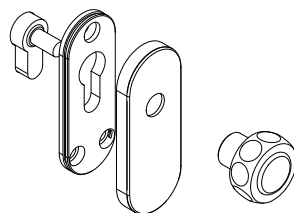

SISTEMA DI MONTAGGIO STANDARD
STANDARD MOUNTING SYSTEM



Finiture
Finishes

OC

OSC

BOCCHETTA CON FORO ASSE PER CILINDRO

CQ6 RO Bocchetta rettangolare con foro asse per cilindretti
Rectangular rose for cylinders with tag

€

€

•

•

art.CQ8 RO



CQ8 RO

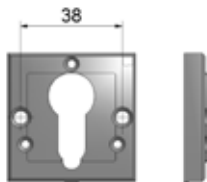
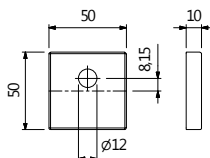

Nylon

Esempio di applicazione
Mounting example

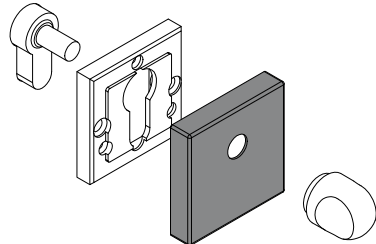

SISTEMA DI MONTAGGIO STANDARD
STANDARD MOUNTING SYSTEM



Finiture
Finishes

LV

OC

OSC

SNV

BOCCHETTA CON FORO ASSE PER CILINDRO

CQ8 RO Bocchetta quadrata con foro asse per cilindretti
Square rose for cylinders with tag

€

€

€

€

•

•

•

•

art.CDJQ8 RO



FLAT LINE



000 CD JQ8

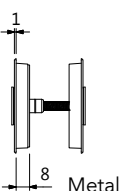
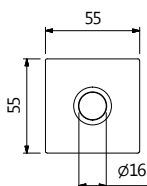

Metal

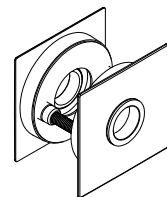
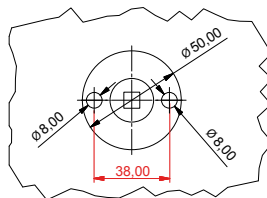

Esempio di applicazione
Mounting example



SISTEMA DI MONTAGGIO STANDARD
STANDARD MOUNTING SYSTEM



Finiture
Finishes

ZCR

ZSC

SNV

PVD
INOX

ROSETTE FLAT LINE QUADRE

CDJQ8RO Set 2 rosette flat line quadre
Set 2 square flat roses

€

€

€

€

•

•

•

•

art.QD5 RO



QD5 RO

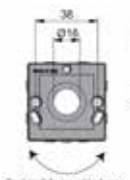
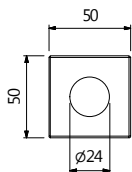

Regolabile con viti a legno
Adjustable with wood screws



Metal

Esempio di applicazione
Mounting example

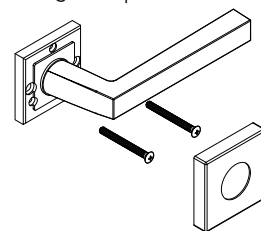

SISTEMA DI MONTAGGIO STANDARD
STANDARD MOUNTING SYSTEM



ROSETTA QUADRATA TIPO LUSO

QD5 RO Rosetta coprivite quadrata su base in metallo con bussole adatta ad applicazione molla
Square Cover screw rose with bushes, internal metal, suitable to insert returning spring

art.QD6 RO



QD6 RO

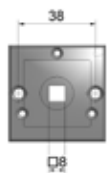
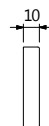
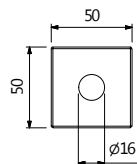

QD6 ML

Nylon

Esempio di applicazione
Mounting example

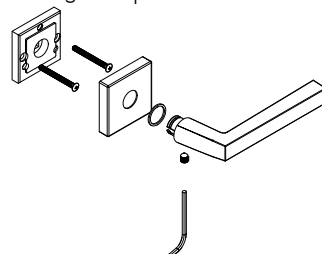

SISTEMA DI MONTAGGIO STANDARD
STANDARD MOUNTING SYSTEM



ROSETTA QUADRATA MM 50X50

QD6 RO Rosetta coprivite quadrata con bussole e con molla ambidestra
Square cover screw rose with bushes and with bidirectional returning spring

QD6 ML Sottorosetta con bussole e con molla ambidestra per ros.QD6RO
Inside part with bushes and bidirectional returning spring for art.QD6RO

Finire
Finishes

OC

OSC

SNV

€

€

€

•

•

•



€

•

art.QD8 RO



QD8 RO

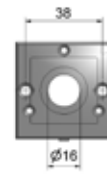
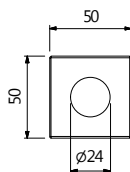

Nylon

Esempio di applicazione
Mounting example

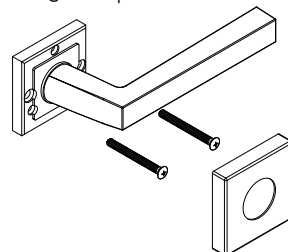

SISTEMA DI MONTAGGIO STANDARD
STANDARD MOUNTING SYSTEM



ROSETTA QUADRATA MM 50X50

QD8 RO Rosetta coprivite quadrata su base in plastica con bussole adatta ad applicazione molla
Square Cover screw rose with bushes, suitable to insert returning spring

art.QN6 RO



Esempio di applicazione
Mounting example



QN6 RO

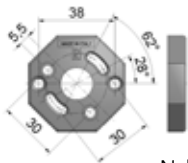
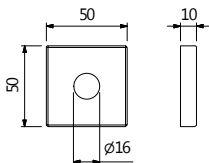

Nylon

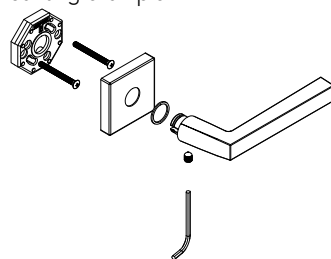

SISTEMA DI MONTAGGIO STANDARD
STANDARD MOUNTING SYSTEM



SISTEMA DI MONTAGGIO A RICHIESTA
ON REQUEST MOUNTING SYSTEM

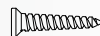

OC	OSC	SNV
€	€	€
•	•	•

ROSETTA QUADRATA MM 50X50

QN6 RO Rosetta coprivite quadrata su base in plastica per montaggio senza molla
Square Cover screw rose without returning spring

art.QP5 RO



Esempio di applicazione
Mounting example



QP5 RO

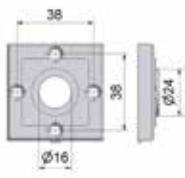
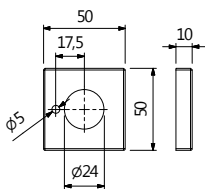

METAL

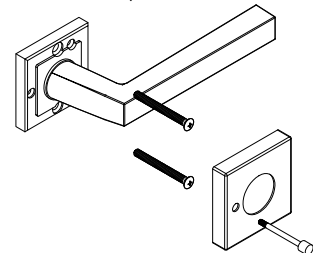

SISTEMA DI MONTAGGIO STANDARD
STANDARD MOUNTING SYSTEM



SISTEMA DI MONTAGGIO A RICHIESTA
ON REQUEST MOUNTING SYSTEM



ROSETTA QUADRATA PRIVACY

QP5 RO Rosetta quadrata "privacy" per standard Australia
Square "privacy" rose for Australian standard

art.QP8 RO



Esempio di applicazione
Mounting example



QP8 RO

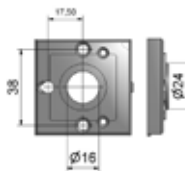
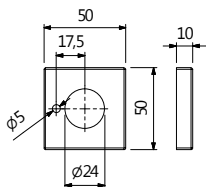

Nylon

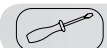
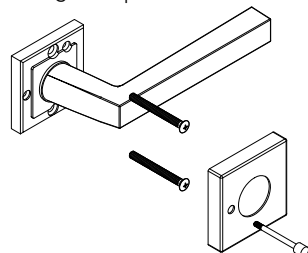

SISTEMA DI MONTAGGIO STANDARD
STANDARD MOUNTING SYSTEM



SISTEMA DI MONTAGGIO A RICHIESTA
ON REQUEST MOUNTING SYSTEM



ROSETTA QUADRATA MM 50X50

QP8 RO Rosetta coprivite privacy quadrata su base in plastica adatta ad applicazione molla per standard Australia
Privacy Square Cover screw rose, suitable to insert returning spring for Australian standard

art.014 RO

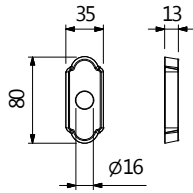

014 RO

Esempio di applicazione
Mounting example

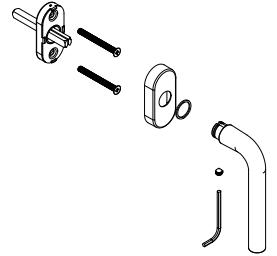

Finiture Finishes	VBN	LV BG	AN BGO	AGV
	€	€	€	€
	•	•	•	•

ROSETTA SAGOMATA PER MOVIMENTO DK MM 65X31

014 RO Rosetta per movimento DK M1
Rose for M1 DK mechanism

art.100 RO

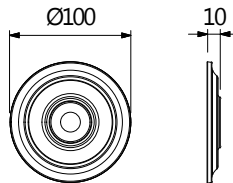

100 RO

Esempio di applicazione
Mounting example

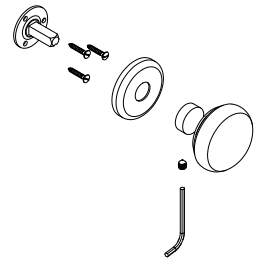

Finiture Finishes	VBN	LV OS BG	AN BGO	AGV
	€	€	€	€
	•	•	•	•

ROSETTA ONDULATA DA MM. 100

100 RO Rosetta per montaggio pomolo
Rose for assembling knobs

art.311 RO

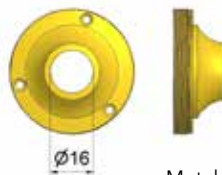
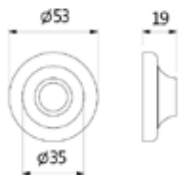

Metal

311 RO

Esempio di applicazione
Mounting example

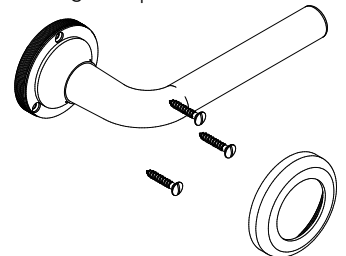

SISTEMA DI MONTAGGIO STANDARD
STANDARD MOUNTING SYSTEM



ROSETTA ELEMENTIA Ø53

311 RO Rosetta coprivite tipo lusso adatta ad applicazione molla ambidestra
Lusso type cover screw rose suitable to insert bidirectional returning spring

art.003 BN



003 BN

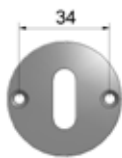
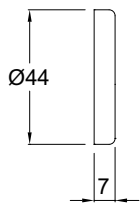

nylon



SISTEMA DI MONTAGGIO STANDARD
STANDARD MOUNTING SYSTEM



Finiture
Finishes

LV-LS
OS- BG

OSC
OC

NR
AN

AGV

RX

PVD

BOCCHETTA Ø45

003 BN Bocchetta coprivite
Cover screw rose for key



Detrazione per articoli senza bocchetta 003 BN
Deduction for items without rose for key 003 BN

	€	€	€	€	€	€
	•	•	•	•	•	•
	•	•	•	•	•	•

art.003 BY



003 BY

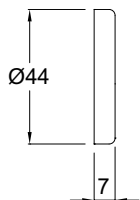

nylon



SISTEMA DI MONTAGGIO STANDARD
STANDARD MOUNTING SYSTEM



Finiture
Finishes

LV-LS
OS- BG

OSC
OC

NR

AN

AGV

PVD

BOCCHETTA Ø45

003 BY Bocchetta coprivite foro yale
Cover screw rose for euro profile cylinder hole (yale)

	€	€	€	€	€	€
	•	•	•	•	•	•

art.003 BC



003 BC

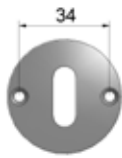
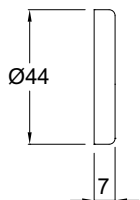

nylon



SISTEMA DI MONTAGGIO STANDARD
STANDARD MOUNTING SYSTEM



Finiture
Finishes

LV
OS- BG

OSC
OC

AN

AGV

BOCCHETTA Ø45

003 BC Bocchetta coprivite cieca
Blind cover screw rose

	€	€	€	€
	•	•	•	•

art.003 DM

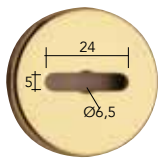

003 DM

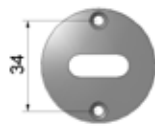
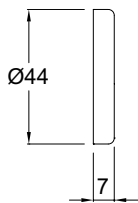

nylon



SISTEMA DI MONTAGGIO STANDARD
STANDARD MOUNTING SYSTEM



Finiture
Finishes

LV - LS
OS - BG

OSC
OC

AN

AGV

BOCCHETTA Ø45

003 DM Bocchetta coprivite foro doppia mappa
Cover screw rose with keyhole for safety

€

€

€

€

•

•

•

•

art.003 BV

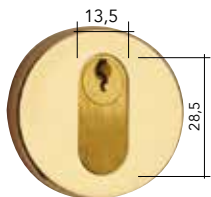

003 BV

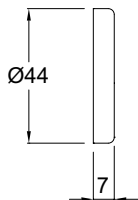

nylon



SISTEMA DI MONTAGGIO STANDARD
STANDARD MOUNTING SYSTEM



Finiture
Finishes

LV - LS
OS - BG

OSC
OC

NR

AN

AGV

PVD

BOCCHETTA Ø45

003 BV Bocchetta con foro cilindro ovale mm 28,5 x 13,5
Cover screw rose with oval cylinder hole mm 28,3x13,7

€

€

€

€

€

•

•

•

•

•

art.004 BY



004 BY

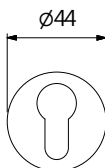

Nylon



SISTEMA DI MONTAGGIO STANDARD
STANDARD MOUNTING SYSTEM



Finiture
Finishes

INOX SAT

BOCCHETTA Ø45

004 BY Bocchetta coprivite foro yale
Cover screw rose with euro profile cylinder

€

•

art.005 BN

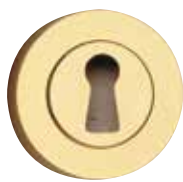

005 BN

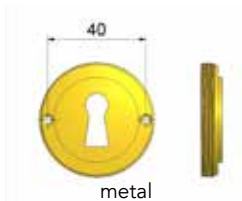
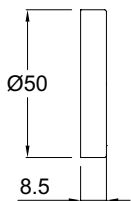

metal



SISTEMA DI MONTAGGIO STANDARD
STANDARD MOUNTING SYSTEM

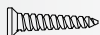

Finiture
Finishes

LV - LS
OS - BG

OSC
OC

OSC/OC
OC/LV

BOCCHETTA Ø50

005 BN Bocchetta coprivite tipo lusso
Lusso type cover screw rose for key



Detrazione per articoli senza bocchetta 005 BN
Deduction for items without rose for key 005 BN

€

€

€

•

•

•

•

•

•

art.005 BY



005 BY

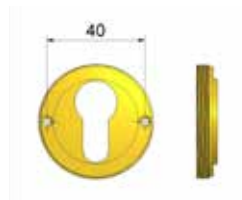
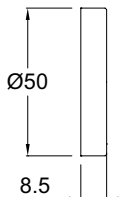

metal



SISTEMA DI MONTAGGIO STANDARD
STANDARD MOUNTING SYSTEM



Finiture
Finishes

LV - LS
OS - BG

OSC
OC

OSC/OC
OC/LV

BOCCHETTA Ø50

005 BY Bocchetta coprivite tipo lusso, foro yale
Lusso type cover screw rose for key euro profile cylinder hole (yale)

€

€

€

•

•

•

art.005 BC

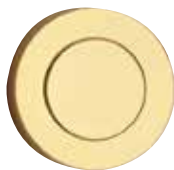

005 BC

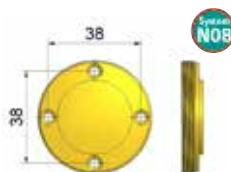
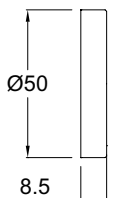

metal



SISTEMA DI MONTAGGIO STANDARD
STANDARD MOUNTING SYSTEM



SISTEMA DI MONTAGGIO A RICHIESTA
ON REQUEST MOUNTING SYSTEM



Finiture
Finishes

LV - LS
OS - BG

OSC
OC

OSC/OC
OC/LV

BOCCHETTA Ø50

005 BC Bocchetta coprivite cieca
Blind cover screw rose

€

€

€

•

•

•

art.005 BW



005 BW

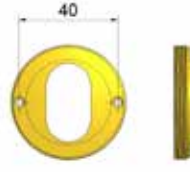
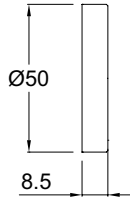

metal



SISTEMA DI MONTAGGIO STANDARD
STANDARD MOUNTING SYSTEM



Finiture
Finishes

LV

OSC
OC

OSC/OC
OC/LV

BOCCHETTA Ø50

005 BW Bocchetta coprivite tipo lusso, foro union 32x18
Lusso type cover screw rose for key, union hole 32x18

€

€

€

•

•

•

art.005 DM

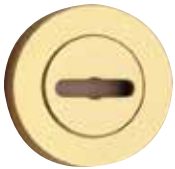

005 BY

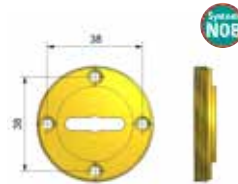
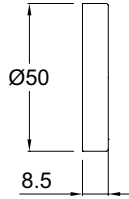

metal



SISTEMA DI MONTAGGIO STANDARD
STANDARD MOUNTING SYSTEM



SISTEMA DI MONTAGGIO A RICHIESTA
ON REQUEST MOUNTING SYSTEM



Finiture
Finishes

LV - LS
OS - BG

OSC
OC

OSC/OC
OC/LV

BOCCHETTA Ø50

005 DM Bocchetta coprivite foro doppia mappa
Cover screw rose with keyhole for safety

€

€

€

•

•

•

art.006 BN



006 BN

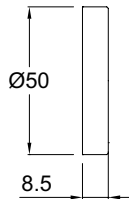

metal



SISTEMA DI MONTAGGIO STANDARD
STANDARD MOUNTING SYSTEM



Finiture
Finishes

LV - LS
OS - BG

OSC
OC

OSC/OC
OC/LV

AGV
NC

PVD

BOCCHETTA Ø50

006 BN Bocchetta coprivite tipo lusso
Lusso type cover screw rose for key

€

€

€

€

€

•

•

•

•

•



Detrazione per articoli senza bocchetta 006 BN
Deduction for items without rose for key 006 BN

•

•

•

•

•

art.006 BY



006 BY

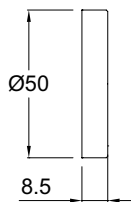

metal



SISTEMA DI MONTAGGIO STANDARD
STANDARD MOUNTING SYSTEM



Finiture
Finishes

LV
BG

OSC
OC

OSC/OC
OC/LV

BOCCHETTA Ø50

006 BY Bocchetta coprivite tipo lusso, foro yale
Lusso type cover screw rose for key euro profile cylinder hole (yale)

€

€

€

•

•

•

art.006 BC



006 BC

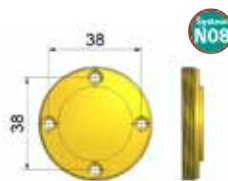
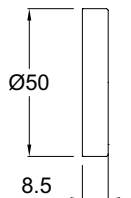

metal



SISTEMA DI MONTAGGIO STANDARD
STANDARD MOUNTING SYSTEM

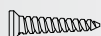

SISTEMA DI MONTAGGIO A RICHIESTA
ON REQUEST MOUNTING SYSTEM



Finiture
Finishes

LV
BG

OSC
OC

OSC/OC
OC/LV

BOCCHETTA Ø50

006 BC Bocchetta coprivite cieca
Blind cover screw rose

€

€

€

•

•

•

art.006 BW



006 BW

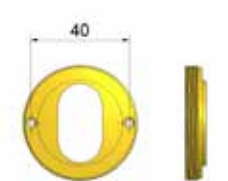
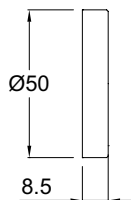

metal



SISTEMA DI MONTAGGIO STANDARD
STANDARD MOUNTING SYSTEM

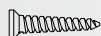

Finiture
Finishes

LV

OSC
OC

OSC/OC
OC/LV

BOCCHETTA Ø50

006 BW Bocchetta coprivite tipo lusso, foro union 32x18
Lusso type cover screw rose for key, union hole 32x18

€

€

€

•

•

•

art.006 DM



006 DM

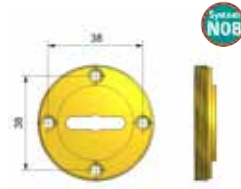
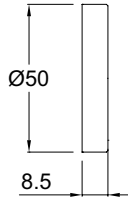

metal



SISTEMA DI MONTAGGIO STANDARD
STANDARD MOUNTING SYSTEM



SISTEMA DI MONTAGGIO A RICHIESTA
ON REQUEST MOUNTING SYSTEM



Finiture
Finishes

LV - LS
OS - BG

OSC
OC

OSC/OC
OC/LV

BOCCHETTA Ø50

006 DM Bocchetta coprivite foro doppia mappa
Cover screw rose with keyhole for safety

€	€	€
•	•	•

art.007 BN

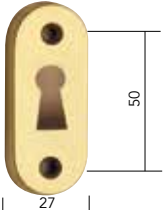

007 BN

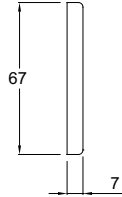

SISTEMA DI MONTAGGIO STANDARD
STANDARD MOUNTING SYSTEM



Finiture
Finishes

LV - LS
OS - BG

OSC
OC

AN

AGV

BOCCHETTA OVALE STRETTA

007 BN Bocchetta coprivite tipo lusso
Lusso type cover screw rose for key



Detrazione per articoli senza bocchetta 007 BN
Deduction for items without rose for key 007 BN

€	€	€	€
•	•	•	•
•	•	•	•

art.007 BY

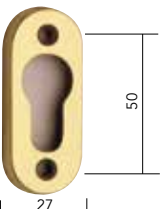

007 BY

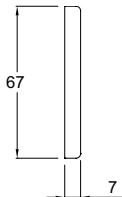

SISTEMA DI MONTAGGIO STANDARD
STANDARD MOUNTING SYSTEM



Finiture
Finishes

LV - LS
OS - BG

OSC
OC

AN

AGV

BOCCHETTA OVALE STRETTA YALE

007 BY Bocchetta ovale mm 67x27 con foro yale
Oval rose for euro profile cylinder hole (yale) mm 67x27

€	€	€	€
•	•	•	•

art.007 BC

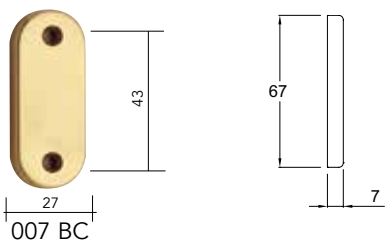

SISTEMA DI MONTAGGIO STANDARD
STANDARD MOUNTING SYSTEM



Finiture
Finishes

LV
BG

OSC
OC

BOCCHETTA OVALE STRETTA

007 BC Bocchetta ovale mm 67x27 cieca
Oval Blind rose mm 67x27

€

€

•

•

art.008 BN

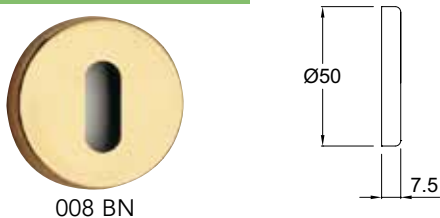

008 BN

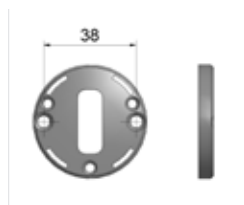

nylon



SISTEMA DI MONTAGGIO STANDARD
STANDARD MOUNTING SYSTEM



SISTEMA DI MONTAGGIO A RICHIESTA
ON REQUEST MOUNTING SYSTEM



Finiture
Finishes

LV
OS
BG

OSC
OC

BOCCHETTA Ø50

008 BN Bocchetta coprivite
Cover screw rose for key

€

€

•

•



Detrazione per articoli senza bocchetta 008 BN
Deduction for items without rose for key 008 BN

•

•

art.008 BY

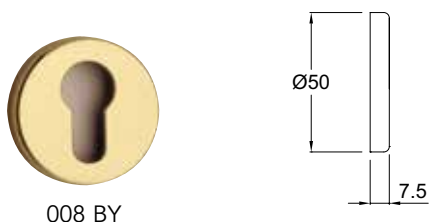

008 BY

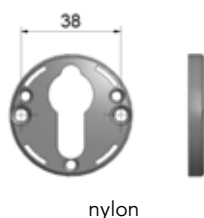

nylon



SISTEMA DI MONTAGGIO STANDARD
STANDARD MOUNTING SYSTEM



SISTEMA DI MONTAGGIO A RICHIESTA
ON REQUEST MOUNTING SYSTEM



Finiture
Finishes

LV
OS-
BG

OSC
OC

BOCCHETTA Ø50 YALE

008 BY Bocchetta coprivite foro yale
Cover screw rose for euro profile cylinder hole (yale)

€

€

•

•

art.008 BC

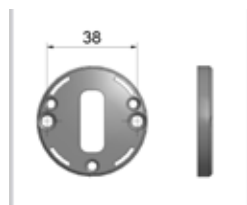
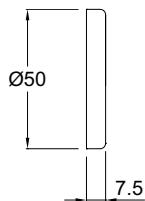

008 BC

nylon

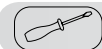

SISTEMA DI MONTAGGIO STANDARD
STANDARD MOUNTING SYSTEM



SISTEMA DI MONTAGGIO A RICHIESTA
ON REQUEST MOUNTING SYSTEM



Finiture
Finishes

LV
OS - BG

OSC
OC

BOCCHETTA Ø50

008 BC Bocchetta coprivite cieca
Blind cover screw rose

€

€

•

•

art.008 DM

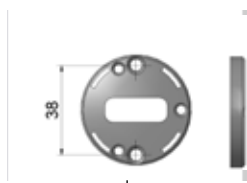
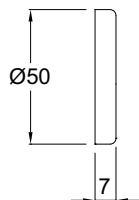
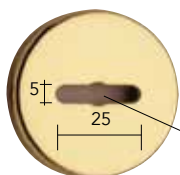

008 DM

nylon

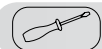

SISTEMA DI MONTAGGIO STANDARD
STANDARD MOUNTING SYSTEM



Finiture
Finishes

LV
OS - BG

OSC
OC

BOCCHETTA Ø50

008 DM Bocchetta coprivite foro doppia mappa
Cover screw rose with keyhole for safety

€

€

•

•

art.009 BN

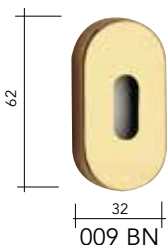

nylon



SISTEMA DI MONTAGGIO STANDARD
STANDARD MOUNTING SYSTEM



Finiture
Finishes

LV
BG

OC
OSC
AN

NR

PVD

BOCCHETTA COPRIVITE OVALE MM 62X32

009 BN Bocchetta ovale
Oval cover screw rose for key

€

€

€

€

•

•

•

•



Detrazione per articoli senza bocchetta 009 BN
Deduction for items without rose for key 009 BN

•

•

•

•

art.009 BY

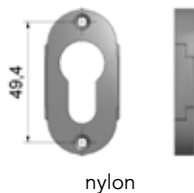

SISTEMA DI MONTAGGIO STANDARD
STANDARD MOUNTING SYSTEM



Finiture Finishes	LV BG	OC OSC AN	NR	PVD
	€	€	€	€
	•	•	•	•

BOCCHETTA COPRIVITE OVALE MM 62X32 YALE

009 BY Bocchetta ovale con foro yale
Oval cover screw rose key euro profile cylinder hole (yale)

art.009 BC

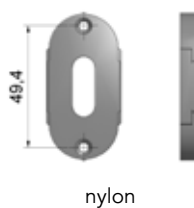
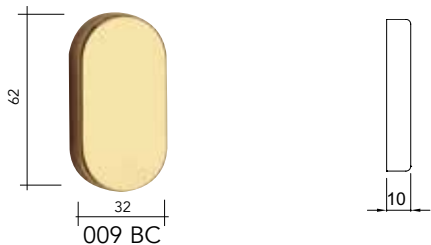

SISTEMA DI MONTAGGIO STANDARD
STANDARD MOUNTING SYSTEM



Finiture Finishes	LV BG	OC OSC AN	NR	PVD
	€	€	€	€
	•	•	•	•

BOCCHETTA COPRIVITE OVALE MM 62X32

009 BC Bocchetta ovale cieca
Oval blind cover screw rose

art.009 BV

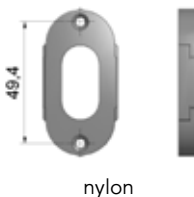
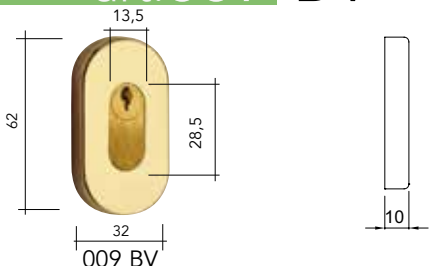

SISTEMA DI MONTAGGIO STANDARD
STANDARD MOUNTING SYSTEM



Finiture Finishes	LV BG OS	OC OSC	AN
	€	€	€
	•	•	•

BOCCHETTA COPRIVITE OVALE MM 62X32

009 BV Bocchetta con foro cilindro ovale mm 28,5 x 13,5
Cover screw rose with oval cylinder hole mm 28,5x13,5

art.011 BN



011 BN

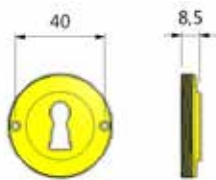
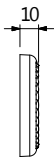
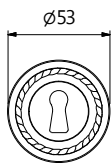

Metal



SISTEMA DI MONTAGGIO STANDARD
STANDARD MOUNTING SYSTEM



Furniture
Finishes

LV

AGV

BGO
AN

BOCCHETTA ELEMENTIA Ø50

011 BN Bocchetta coprivite tipo lusso
Lusso type cover screw rose for key



Detrazione per articoli senza bocchetta 011BN
Deduction for items without rose for key 011BN

€

€

€

•

•

•

•

•

•

art.011 BY



011 BY

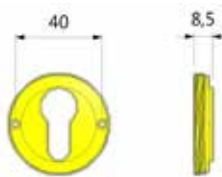
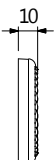
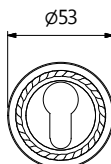

Metal



SISTEMA DI MONTAGGIO STANDARD
STANDARD MOUNTING SYSTEM



Furniture
Finishes

LV

AGV

BGO

AN

BOCCHETTA ELEMENTIA Ø50 YALE

011 BY Bocchetta coprivite tipo lusso, foro yale
Lusso type cover screw rose for key euro profile cylinder hole (yale)

€

€

€

€

•

•

•

•

art.022 BN minimal line



022 BN

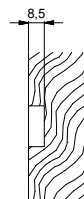
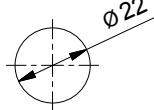
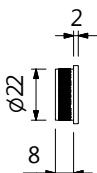
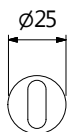

SISTEMA DI MONTAGGIO STANDARD
STANDARD MOUNTING SYSTEM



COLLA / GLUE



Furniture
Finishes

LV

OC
OSC

SNV

PVD
INOX

BOCCHETTA MINIMAL

022 BN Bocchetta MINIMAL tonda d.25
MINIMAL round rose for key d.25



Detrazione per articoli senza bocchetta 022BN
Deduction for items without rose for key 022BN

€

€

€

€

•

•

•

•

•

•

•

art.022 BY MINIMAL LINE



022 BY

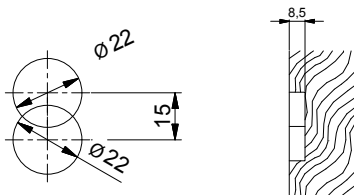
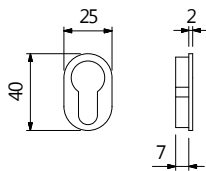

SISTEMA DI MONTAGGIO STANDARD
STANDARD MOUNTING SYSTEM



COLLA / GLUE



Finiture
Finishes

LV	OC	OSC	SNV	PVD INOX
€	€	€	€	€
•	•	•	•	•

BOCCHETTA MINIMAL YALE

022 BY Bocchetta MINIMAL ovale mm.25x40, foro yale
MINIMAL oval rose for euro profile cylinder hole (yale) mm.25x40

art.037 BN

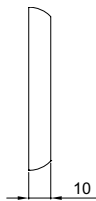
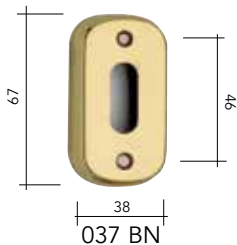

SISTEMA DI MONTAGGIO STANDARD
STANDARD MOUNTING SYSTEM



Finiture
Finishes

LV
LS
BG

BOCCHETTA MM 38X67

037 BN Bocchetta
Rose for key



Detrazione per articoli senza bocchetta 037 BN
Deduction for items without rose for key 037 BN

€

•

•

art.037 BY

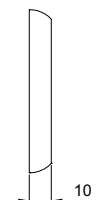
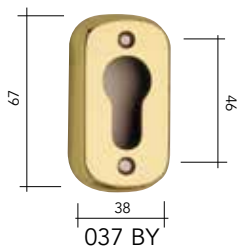

SISTEMA DI MONTAGGIO STANDARD
STANDARD MOUNTING SYSTEM



Finiture
Finishes

LV
LS
BG

BOCCHETTA MM 67X38 YALE

037 BY Bocchetta con foro yale
Rose for euro profile cylinder hole (yale)

€

•

art.040 BN

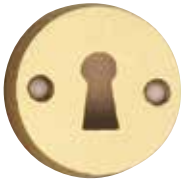

040 BN

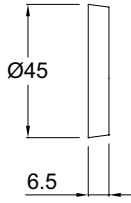

SISTEMA DI MONTAGGIO STANDARD
STANDARD MOUNTING SYSTEM



Finiture
Finishes

LV BG	OL	OC	AN
----------	----	----	----

BOCCHETTA Ø45

040 BN

Bocchetta con fori viti a vista
Rose for key with screws holes



Detrazione per articoli senza bocchetta 040 BN
Deduction for items without rose for key 040 BN

€	€	€	€
•	•	•	•
•	•	•	•

art.040 BY



040 BY

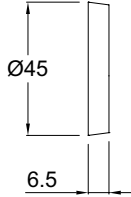

SISTEMA DI MONTAGGIO STANDARD
STANDARD MOUNTING SYSTEM



Finiture
Finishes

LV BG	OL	OC	AN
----------	----	----	----

BOCCHETTA COPRIVITE OVALE MM 62X32 YALE

040 BY

Bocchetta con foro yale
Rose for euro profile cylinder (yale)

€	€	€	€
•	•	•	•

art.050 BN

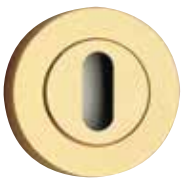

050 BN*

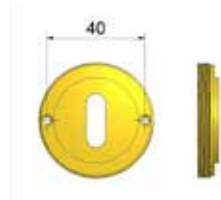
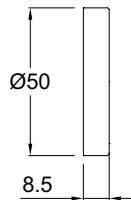

metal

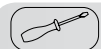

SISTEMA DI MONTAGGIO STANDARD
STANDARD MOUNTING SYSTEM



Finiture
Finishes

LV-OS BG	OSC OC	OSC/OC OC/LV
-------------	-----------	-----------------

BOCCHETTA Ø50

050 BN

Bocchetta coprivite tipo lusso
Lusso type cover screw rose for key

€	€	€
•	•	•

* solo su richiesta
only on request

art.052 BN

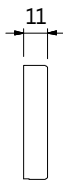
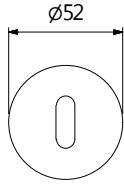

nylon

052 BN



SISTEMA DI MONTAGGIO STANDARD
STANDARD MOUNTING SYSTEM



SISTEMA DI MONTAGGIO A RICHIESTA
ON REQUEST MOUNTING SYSTEM



Finiture
Finishes

LV

OSC

BOCCHETTA Ø52

052 BN Bocchetta coprivite foro chiave
Cover screw rose with key hole



Detrazione per articoli senza bocchetta 052BN
Deduction for items without rose for key 052BN

	LV	OSC
€	€	€
•	•	•
•	•	•

art.052 BY

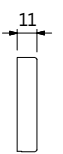
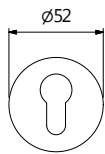

nylon

052 BY



SISTEMA DI MONTAGGIO STANDARD
STANDARD MOUNTING SYSTEM

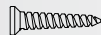

SISTEMA DI MONTAGGIO A RICHIESTA
ON REQUEST MOUNTING SYSTEM



Finiture
Finishes

LV

OSC

BOCCHETTA YALE Ø52

052 BY Bocchetta coprivite foro yale
Cover screw rose for euro profile cylinder hole (yale)

	LV	OSC
€	€	€
•	•	•
•	•	•

art.055 BY

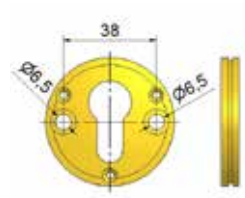
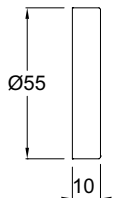

metal

055 BY



SISTEMA DI MONTAGGIO STANDARD
STANDARD MOUNTING SYSTEM

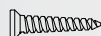

SISTEMA DI MONTAGGIO A RICHIESTA
ON REQUEST MOUNTING SYSTEM



Bocchette adatte A VITI PASSANTI INTERASSE mm 38
ROSE FOR KEY SUITABLE FOR DOOR THROUGH SCREWS DIST. mm 38



Finiture
Finishes

LV
BG

OSC
OC

BOCCHETTA Ø55 SU BASE IN OTTONE YALE

055 BY Bocchetta coprivite foro yale
Cover screw rose for euro profile cylinder hole (yale)

	LV BG	OSC OC
€	€	€
•	•	•
•	•	•

art.055 BC



055 BC

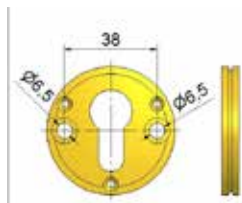
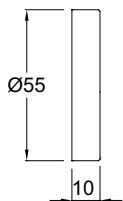

metal



SISTEMA DI MONTAGGIO STANDARD
STANDARD MOUNTING SYSTEM



SISTEMA DI MONTAGGIO A RICHIESTA
ON REQUEST MOUNTING SYSTEM



Bocchette adatte A VITI PASSANTI INTERASSE mm 38
ROSE FOR KEY SUITABLE FOR DOOR THROUGH SCREWS DIST. mm 38



Finiture
Finishes

LV
BG

OSC
OC

BOCCHETTA Ø55 SU BASE IN OTTONE

055 BC Bocchetta coprivite cieca
Blind cover screw rose

€

€

•

•

art.055 DM

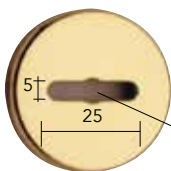

055 DM

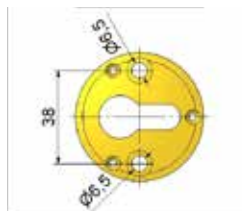
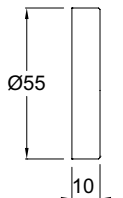

metal



SISTEMA DI MONTAGGIO STANDARD
STANDARD MOUNTING SYSTEM



Finiture
Finishes

LV
BG

OSC
OC

BOCCHETTA Ø55 SU BASE IN OTTONE

055 DM Bocchetta coprivite foro doppia mappa
Cover screw rose with keyhole for safety

€

€

•

•

art.060 BN



060 BN*

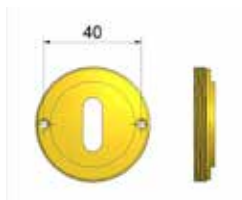
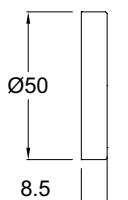

metal



SISTEMA DI MONTAGGIO STANDARD
STANDARD MOUNTING SYSTEM



*Solo su richiesta / Only on request



Finiture
Finishes

LV-OS
BG

OSC
OC

OSC/OC
OC/LV

BOCCHETTA Ø50

060 BN Bocchetta coprivite tipo lusso
Lusso type cover screw rose for key

€

€

€

•

•

•

art.068 BN



068 BN

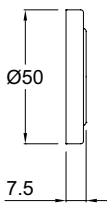

nylon



SISTEMA DI MONTAGGIO STANDARD
STANDARD MOUNTING SYSTEM



SISTEMA DI MONTAGGIO A RICHIESTA
ON REQUEST MOUNTING SYSTEM



Finiture
Finishes

LV

OSC
OC

OSC/OC

BOCCHETTA Ø50

068 BN Bocchetta coprivite
Cover screw rose for key



Detrazione per maniglie fornite con rosetta 006 o 382 con bocchette 068 anziché 006
Deduction for pairs levers on rose 006 or 382 with key roses 068 instead of 006

€

€

€

•

•

•

art.D68 BN



D68 BN

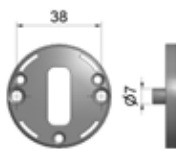
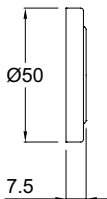

nylon



SISTEMA DI MONTAGGIO STANDARD
STANDARD MOUNTING SYSTEM



Finiture
Finishes

LV

OSC
OC

OSC/OC

BOCCHETTA Ø50

D68 BN Bocchetta coprivite con bussole
Cover screw rose for key with bushes

€

€

€

•

•

•

art.068 BY



068 BY

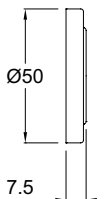

nylon



SISTEMA DI MONTAGGIO STANDARD
STANDARD MOUNTING SYSTEM



SISTEMA DI MONTAGGIO A RICHIESTA
ON REQUEST MOUNTING SYSTEM



Finiture
Finishes

LV

OSC
OC

OSC/OC

BOCCHETTA Ø 50 YALE

006 BY Bocchetta coprivite foro yale
Cover screw rose for euro profile cylinder hole (yale)



Detrazione per maniglie fornite con rosetta 006 o 382 con bocchette 068 anziché 006
Deduction for pairs levers on rose 006 or 382 with key roses 068 instead of 006

€

€

€

•

•

•

art.D68 BY



D68 BY

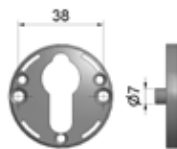
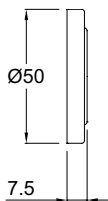

nylon



SISTEMA DI MONTAGGIO STANDARD
STANDARD MOUNTING SYSTEM



Finiture
Finishes

LV

OSC
OC

OSC/OC

BOCCHETTA Ø50 YALE

D68 BY Bocchetta coprivite foro yale con bussole
Cover screw rose for euro profile cylinder hole (yale) with bushes

€

€

•

•

•

art.200 BN



200 BN

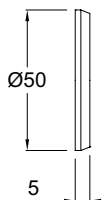

SISTEMA DI MONTAGGIO STANDARD
STANDARD MOUNTING SYSTEM



SISTEMA DI MONTAGGIO A RICHIESTA
ON REQUEST MOUNTING SYSTEM



BOCCHETTA Ø50

200 BN Bocchetta con fori viti a vista
Rose for key with screws holes

art.202 BN



202 BN

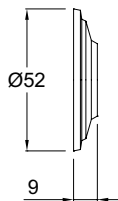

SISTEMA DI MONTAGGIO STANDARD
STANDARD MOUNTING SYSTEM

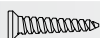

SISTEMA DI MONTAGGIO A RICHIESTA
ON REQUEST MOUNTING SYSTEM



Finiture
Finishes

LV
BG

AN

AGV

NC

BOCCHETTA Ø52

202 BN Bocchetta con bordo
Board rose for key

€

€

€

€

•

•

•

•



Detrazione per articoli senza bocchetta 202 BN
Deduction for items without rose for key 202 BN

•

•

•

•

art.202 BY



30
202 BY

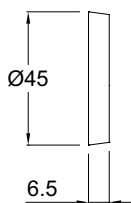

SISTEMA DI MONTAGGIO STANDARD
STANDARD MOUNTING SYSTEM



SISTEMA DI MONTAGGIO A RICHIESTA
ON REQUEST MOUNTING SYSTEM



Finiture
Finishes

LV
BG

AN

AGV

NC

BOCCHETTA Ø52 YALE

202 BY Bocchetta con bordo con foro yale
Board rose for euro profile cylinder hole (yale)

€	€	€	€
•	•	•	•

art.202 BC

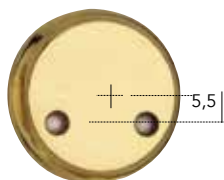

30
202 BC

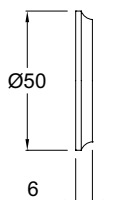

SISTEMA DI MONTAGGIO STANDARD
STANDARD MOUNTING SYSTEM



SISTEMA DI MONTAGGIO A RICHIESTA
ON REQUEST MOUNTING SYSTEM



Finiture
Finishes

LV
BG

AN

AGV

NC

BOCCHETTA Ø50

202 BC Bocchetta con bordo cieca con 2 fori viti
Board blind rose with 2 screw holes

€	€	€	€
•	•	•	•

art.204 BY



30
204 BY

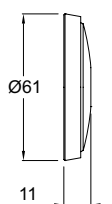

SISTEMA DI MONTAGGIO STANDARD
STANDARD MOUNTING SYSTEM



Finiture
Finishes

LV

OSC
OC

BOCCHETTA Ø60 YALE

204 BY Bocchetta con foro yale
Rose for euro profile cylinder hole (yale)

€	€
•	•

art.206 BN



206 BN

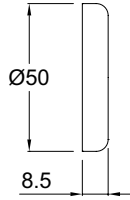

metal

System 2000

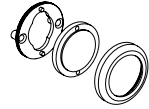

SISTEMA DI MONTAGGIO STANDARD
STANDARD MOUNTING SYSTEM



SISTEMA DI MONTAGGIO A RICHIESTA
ON REQUEST MOUNTING SYSTEM

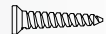

BOCCHETTA Ø50

206 BN Bocchetta coprivite tipo lusso
Lusso type cover screw rose for key - for scandinavian locks

art.11D BY - 11D BN



11D BY

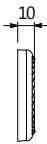
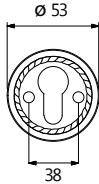

11D BN

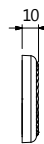
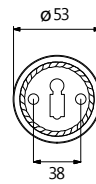

SISTEMA DI MONTAGGIO STANDARD
STANDARD MOUNTING SYSTEM



+6%

Finiture
Finishes

LV
BG

BGO
AN

AGV

BOCCHETTA Ø53

11D BY Bocchetta ø 53 foro yale con due fori viti a vista
Rose ø 53 for euro profile cylinder hole (yale-PZ) with two screws holes

11D BN Bocchetta ø 53 con due fori viti a vista
Rose ø 53 for key with two screws holes



Detrazione per articoli senza bocchetta D11
Deduction for items without rose for key D11

€

€

€

•

•

•

•

•

•

•

•

•

art.38D BY - 38D BN



38D BY

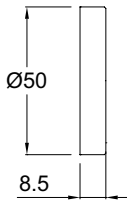

38D BN

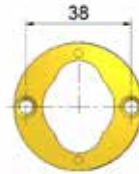

metal

System
R38

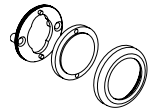

SISTEMA DI MONTAGGIO STANDARD
STANDARD MOUNTING SYSTEM



+6%

Finiture
Finishes

LV
OS

OSC
OC

BOCCHETTA Ø50 YALE

38D BY Bocchetta coprivite foro yale su base senza bussole
Rose for euro profile cylinder hole (yale-PZ) on base without projecting bushes

38D BN Bocchetta coprivite su base senza bussole
Rose for key on base without projecting bushes



Detrazione per articoli senza bocchetta D38 BN - D73
Deduction for items without rose for key D38 BN - D73

€

€

•

•

•

•

•

•

art.0B7 BY

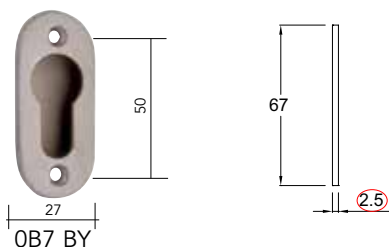

SISTEMA DI MONTAGGIO STANDARD
STANDARD MOUNTING SYSTEM



Finiture
Finishes

LV
OS- BG

OSC
OC

AN

AGV

BOCCHETTA OVALE STRETTA BASSA YALE

0B7 BY Bocchetta ovale stretta mm 67 x 27 tipo basso spessore mm 2,5 con foro yale

€	€	€	€
•	•	•	•

art.0B7 BV

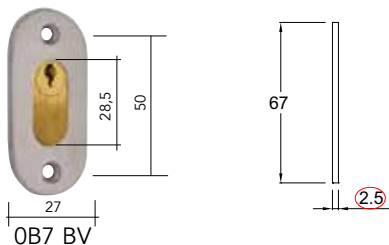

SISTEMA DI MONTAGGIO STANDARD
STANDARD MOUNTING SYSTEM



Finiture
Finishes

LV

OSC
OC

BOCCHETTA OVALE STRETTA BASSA

0B7 BV Bocchetta ovale stretta mm 67 x 27 tipo basso spessore mm 2,10 - con foro cilindro ovale mm 28,5 x 13,5

€	€
•	•

art.D05 BY



D05 BY

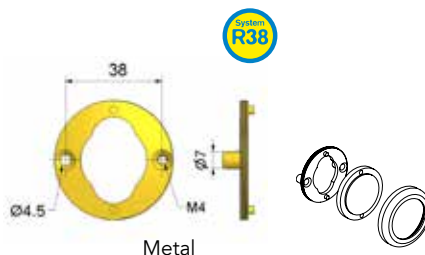

Metal



SISTEMA DI MONTAGGIO STANDARD
STANDARD MOUNTING SYSTEM



Finiture
Finishes

LV
OS

OSC
OC

BOCCHETTA Ø50 YALE

D05 BY Bocchetta coprivite yale su base con 2 bussole fisse sporgenti
Cover screw rose for euro profile cylinder hole (yale-PZ) on base with fix projecting bushes

€	€
•	•

art. D05 BK



D05 BK

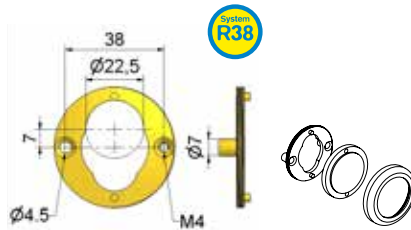
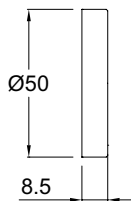

Metal



SISTEMA DI MONTAGGIO STANDARD
STANDARD MOUNTING SYSTEM



Finiture
Finishes

LV
OS

OSC
OC

BOCCHETTA Ø50

D05 BK Bocchetta coprivite con foro Kaba con 2 bussole fisse sporgenti e filetti M4
Cover screw rose for Kaba cylinder on base with fix projecting bushes

€

€

•

•

art. D06 BY



D06 BY

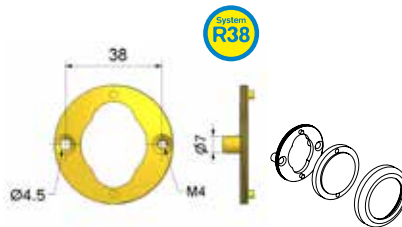
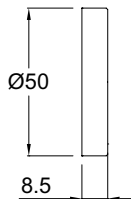

Metal



SISTEMA DI MONTAGGIO STANDARD
STANDARD MOUNTING SYSTEM



Finiture
Finishes

LV
OS

OSC
OC

BOCCHETTA Ø50 YALE

D06 BY Bocchetta coprivite yale su base con 2 bussole fisse sporgenti
Cover screw rose for euro profile cylinder hole (yale-PZ) on base with fix projecting bushes

€

€

•

•

art. D06 BK



D06 BK

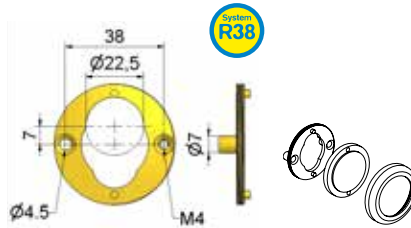
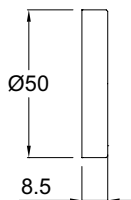

Metal



SISTEMA DI MONTAGGIO STANDARD
STANDARD MOUNTING SYSTEM



Finiture
Finishes

LV
OS

OSC
OC

BOCCHETTA Ø50

D06 BK Bocchetta coprivite con foro Kaba con 2 bussole fisse sporgenti filet. M4
Cover screw rose for Kaba cylinder on base with fix projecting bushes

€

€

•

•

art.D08 BN



D08 BN

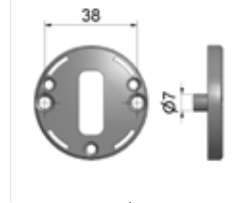
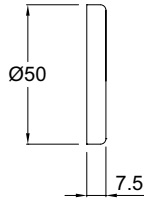

nylon



SISTEMA DI MONTAGGIO STANDARD
STANDARD MOUNTING SYSTEM



Finiture
Finishes

LV
OS
BG

OSC
OC

BOCCHETTA Ø50

D08 BN Bocchetta coprivite con bussole
Cover screw rose for key with bushes

€

€

•

•

art.D08 BY



D08 BY

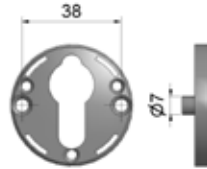
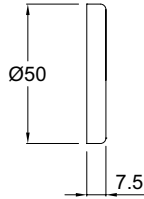

nylon



SISTEMA DI MONTAGGIO STANDARD
STANDARD MOUNTING SYSTEM



Finiture
Finishes

LV
OS- BG

OSC
OC

BOCCHETTA Ø50 YALE

D08 BY Bocchetta coprivite foro yale con bussole
Cover screw rose for euro profile cylinder hole (yale) with bushes

€

€

•

•

art.D08 BC



D08 BC

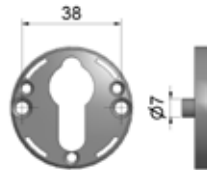
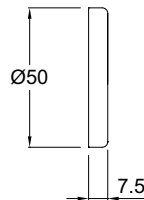

nylon



SISTEMA DI MONTAGGIO STANDARD
STANDARD MOUNTING SYSTEM



SISTEMA DI MONTAGGIO A RICHIESTA
ON REQUEST MOUNTING SYSTEM



Finiture
Finishes

LV
OS- BG

OSC
OC

BOCCHETTA Ø50

D08 BC Bocchetta coprivite cieca
Blind cover screw rose

€

€

•

•

art.D11 BN



D11 BN

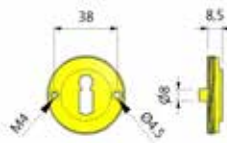
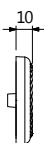
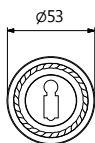

Metal



SISTEMA DI MONTAGGIO STANDARD
STANDARD MOUNTING SYSTEM



LV AGV BGO AN

BOCCHETTA ELEMENTIA Ø53

D11 BN Bocchetta coprivite tipo lusso con bussole
Lusso type cover scr.rose for key, with bushes



Detrazione per articoli senza bocchetta D11BN
Deduction for items without rose for key D11BN

€	€	€	€
•	•	•	•
•-	•-	•-	•-

art.D11 BY



D11 BY

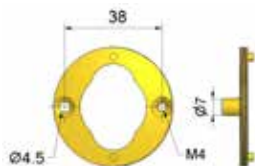
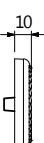
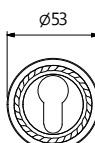

Metal



SISTEMA DI MONTAGGIO STANDARD
STANDARD MOUNTING SYSTEM



LV AGV BGO AN

BOCCHETTA ELEMENTIA Ø53 YALE

D11 BY Bocchetta coprivite tipo lusso con bussole, foro yale
Lusso type cover scr.rose for euro profile cylinder (yale), with bushes

€	€	€	€
•	•	•	•

art.D38 BN



006 BN

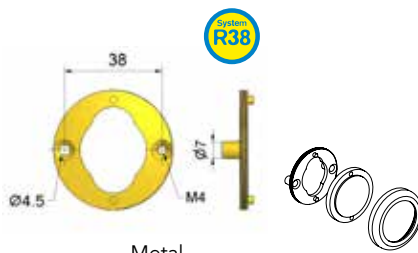
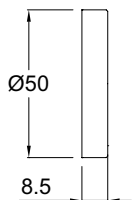

Metal



SISTEMA DI MONTAGGIO STANDARD
STANDARD MOUNTING SYSTEM



LV-LS OS- BG OSC OC

BOCCHETTA Ø50

D38 BN Bocchetta coprivite su base con 2 bussole fisse sporgenti
Rose for key on base with fix projecting bushes



Detrazione per articoli senza bocchetta D38 BN
Deduction for items without rose for key D38 BN

€	€
•	•
•	•

art.CDJ08 BN FLAT LINE



CDJ08 BN

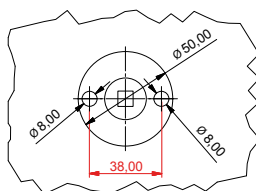
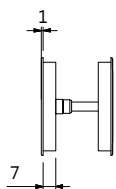
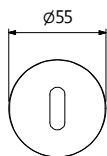

Metal



SISTEMA DI MONTAGGIO STANDARD
STANDARD MOUNTING SYSTEM



Finiture
Finishes

ZCR
ZSC

SNV

BOCCHETTA FLAT LINE

000 CD J082B Set 2 bocchette tonde flat line
Set 2 round flat roses for key



Detrazione per articoli senza bocchetta CDJQ8
Deduction for items without rose for key CDJQ(8)

€

€

-

art.CDJ08 BY FLAT LINE



CDJ08 BY

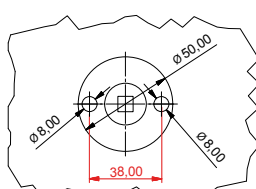
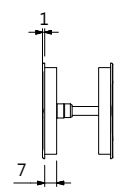
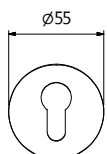

Metal



SISTEMA DI MONTAGGIO STANDARD
STANDARD MOUNTING SYSTEM



Finiture
Finishes

ZCR
ZSC

SNV

BOCCHETTA FLAT LINE

000 CD J082Y Set 2 bocchette tonde flat line
Set 2 round flat roses for key

€

€

art.N08 BN



N08 BN*

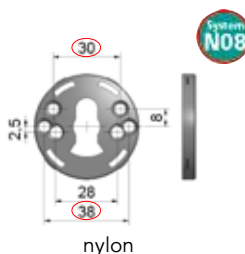
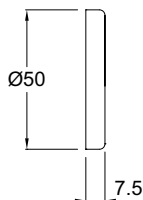

nylon



SISTEMA DI MONTAGGIO STANDARD
STANDARD MOUNTING SYSTEM

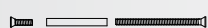

SISTEMA DI MONTAGGIO A RICHIESTA
ON REQUEST MOUNTING SYSTEM



* Fori viti adatti alle viti passanti - INTERASSE mm 30 e 38
Screws-holes suitable for door through screws centre to centre mm 30 and 38

BOCCHETTA Ø50 YALE

N08 BN* Bocchetta coprivite
Cover screw rose for key

art. N08 BC



N08 BC*

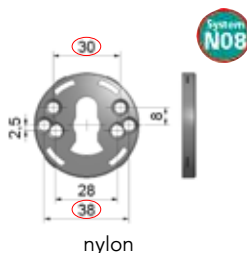
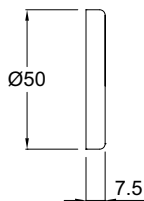

nylon

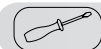

SISTEMA DI MONTAGGIO STANDARD
STANDARD MOUNTING SYSTEM



SISTEMA DI MONTAGGIO A RICHIESTA
ON REQUEST MOUNTING SYSTEM



* Fori viti adatti alle viti passanti - INTERASSE mm 30 e 38
Screws-holes suitable for door through screws centre to centre mm 30 and 38

BOCCHETTA Ø50

N08 BC* Bocchetta coprivite cieca
Blind cover screw rose

art. Q04 BN



Q04 BN

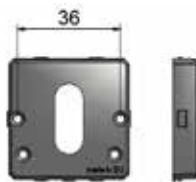
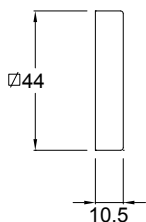

Nylon

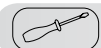

SISTEMA DI MONTAGGIO STANDARD
STANDARD MOUNTING SYSTEM



Furniture
Finishes

LV

OC
OSC

SNV

BOCCHETTA QUADRATA MM.45X45

Q04 BN Bocchetta coprivite quadrata
Square cover screw rose for key



Detrazione per articoli senza bocchetta Q08BN
Deduction for items without rose for key Q08BN

€	€	€
•	•	•
-•	-•	-•

art. Q04 BY



Q04 BY

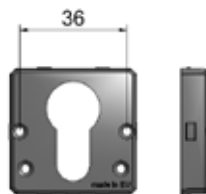
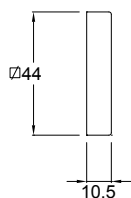

Nylon



SISTEMA DI MONTAGGIO STANDARD
STANDARD MOUNTING SYSTEM



Furniture
Finishes

LV

OC

OSC

SNV

BOCCHETTA QUADRATA MM.45X45 YALE

Q04 BY Bocchetta coprivite quadrata yale
Square cover screw rose for euro profile cylinder hole (yale)

€	€	€	€
•	•	•	•

art. Q08 BN



Q08 BN

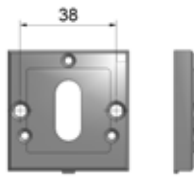
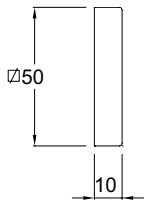

nylon



SISTEMA DI MONTAGGIO STANDARD
STANDARD MOUNTING SYSTEM



SISTEMA DI MONTAGGIO A RICHIESTA
ON REQUEST MOUNTING SYSTEM



Finiture
Finishes

LV

OSC
OC

BOCCHETTA Ø50

Q08 BN Bocchetta coprivite quadrata
Square cover screw rose for key



Detrazione per articoli senza bocchetta Q08 BN
Deduction for items without rose for key Q08 BN

	LV	OSC OC
	€	€
	•	•
	•	•

art. Q08 BY



Q08 BY

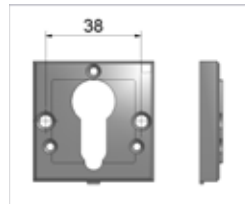
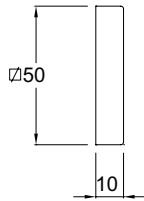

nylon



SISTEMA DI MONTAGGIO STANDARD
STANDARD MOUNTING SYSTEM



SISTEMA DI MONTAGGIO A RICHIESTA
ON REQUEST MOUNTING SYSTEM



Finiture
Finishes

LV

OSC
OC

BOCCHETTA Ø50 YALE

Q08 BY Bocchetta coprivite quadrata foro yale
Square Cover screw rose for euro profile cylinder hole (yale)

	LV	OSC OC
	€	€
	•	•

art. Q08 DM



Q08 DM

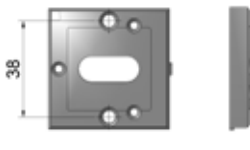
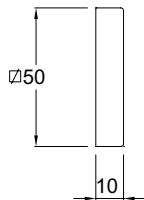

nylon



SISTEMA DI MONTAGGIO STANDARD
STANDARD MOUNTING SYSTEM



Finiture
Finishes

LV

OSC
OC

BOCCHETTA QUADRATA DOPPIA MAPPA

Q08 DM Bocchetta coprivite quadrata foro doppia mappa
Square Cover screw rose with keyhole for safety

	LV	OSC OC
	€	€
	•	•

art. Q08 BC



Q08 BC

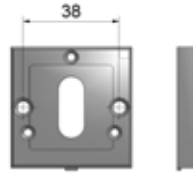
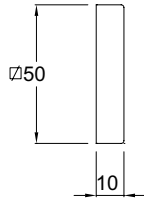

nylon

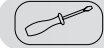

SISTEMA DI MONTAGGIO STANDARD
STANDARD MOUNTING SYSTEM

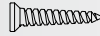

Finiture
Finishes

LV

OSC
OC

BOCCHETTA QUADRATA CIECA MM 50X10

Q08 BC Bocchetta coprivite quadrata cieca
Square Blind cover screw rose

€

€

•

•

art. Q09 BN

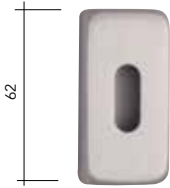

Q09 BN

62

32

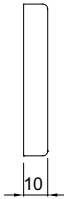

10



49,4

nylon



SISTEMA DI MONTAGGIO STANDARD
STANDARD MOUNTING SYSTEM



Finiture
Finishes

LV

OSC
OC

BOCCHETTA COPRIVITE MM 62X32

Q09 BN Bocchetta ovale
Oval cover screw rose for key

€

€

•

•



Detrazione per articoli senza bocchetta Q09 BN
Deduction for items without rose for key Q09 BN

•

•

art. Q09 BY - Q09 BC

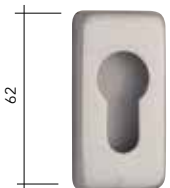

Q09 BY

62

32

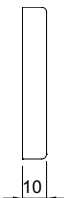

10



49,4

nylon

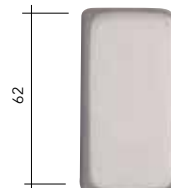

Q09 BC

62

32

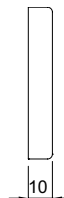

10



49,4

nylon

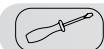

SISTEMA DI MONTAGGIO STANDARD
STANDARD MOUNTING SYSTEM



Finiture
Finishes

LV

OSC
OC

BOCCHETTA COPRIVITE MM 62X32 YALE E CIECA

Q09 BY Bocchetta coprivite mm 62x32 con foro yale
Square Cover screw rose mm 62x32 euro profile cylinder hole (yale)

€

€

•

•

Q09 BC Bocchetta coprivite mm 62x32 cieca
Rectangular blind cover screw rose

•

•

art.Q22 BN minimal line



Q22 BN

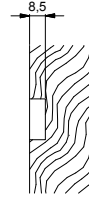
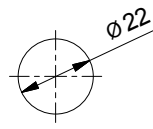
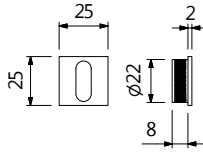

SISTEMA DI MONTAGGIO STANDARD
STANDARD MOUNTING SYSTEM



COLLA / GLUE



Finiture
Finishes

OC	OSC	SNV	PVD INOX
----	-----	-----	----------

BOCCHETTA MINIMAL

Q22 BN Bocchetta MINIMAL quadra mm.25x25
MINIMAL square rose for key mm.25x25



Detrazione per articoli senza bocchetta Q22BN
Deduction for items without rose for key Q22BN

€	€	€	€
•	•	•	•
	-•		-•

art.Q22 BY minimal line



Q22 BY

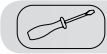
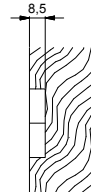
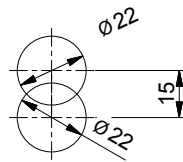
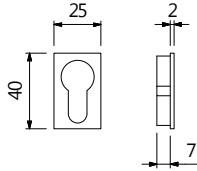

SISTEMA DI MONTAGGIO STANDARD
STANDARD MOUNTING SYSTEM



COLLA / GLUE



Finiture
Finishes

OC	OSC	SNV	PVD INOX
----	-----	-----	----------

BOCCHETTA MINIMAL YALE

Q22 BY Bocchetta rettangolare yale MINIMAL, mm.25x40
MINIMAL rectangular rose for euro profile cylinder (yale) mm.25x40

€	€	€	€
•	•	•	•

art.S08 BN FLAT LINE



S08 BN

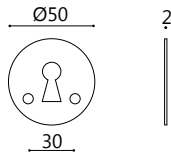

SISTEMA DI MONTAGGIO STANDARD
STANDARD MOUNTING SYSTEM



BOCCHETTA FLAT Ø50

S08 BN Bocchetta FLAT con 2 fori viti in vista
FLAT rose for key, with 2 screws holes

art. T33 BN



T33 BN

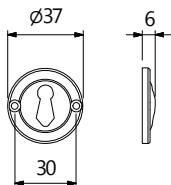

SISTEMA DI MONTAGGIO STANDARD
STANDARD MOUNTING SYSTEM



Finiture
Finishes

LV - BG
VBN - LR

AGV

BGO
AN

BOCCHETTA Ø37

T33 BN Bocchetta con 2 fori viti a vista
Rose for key wit 2 screws holes



Detrazione per articoli senza bocchetta T33BN
Deduction for items without rose for key T33BN

€

€

€

•

•

•

•

•

•

art. T36 BN



T36 BN

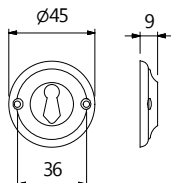

SISTEMA DI MONTAGGIO STANDARD
STANDARD MOUNTING SYSTEM



Finiture
Finishes

LV - BG
VBN - LR

OC
OSC

AGV

BGO
AN

BOCCHETTA Ø45

T36 BN Bocchetta con 2 fori viti a vista
Rose for key wit 2 screws holes



Detrazione per articoli senza bocchetta T36BN
Deduction for items without rose for key T36BN

€

€

€

€

•

•

•

•

•

•

•

•

art. BB5 BN

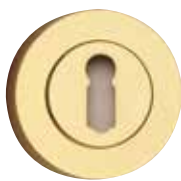

BB5 BN

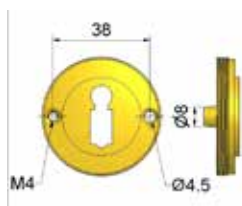
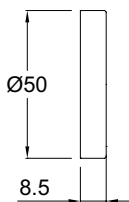

metal

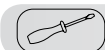

SISTEMA DI MONTAGGIO STANDARD
STANDARD MOUNTING SYSTEM



Finiture
Finishes

LV
OS

OSC
OC

BOCCHETTA Ø50

BB5 BN Bocchetta coprivite con 2 bussole sporgenti
Cover screw rose for key with projecting bushes



Detrazione per articoli senza bocchetta BB5 BN
Deduction for items without rose for key BB5 BN

€

€

•

•

•

•

art. BB6 BN



BB6BN

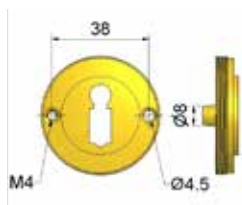
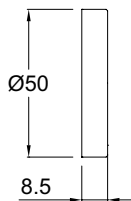

SISTEMA DI MONTAGGIO STANDARD
STANDARD MOUNTING SYSTEM



Finiture
Finishes

LV
OS

OSC
OC

BOCCHETTA Ø50

BB6 BN Bocchetta coprivite con 2 bussole sporgenti
Cover screw rose for key with projecting bushes



Detrazione per articoli senza bocchetta BB6 BN
Deduction for items without rose for key BB6 BN

€

€

•

•

•

•

art. CDJQ8 BN



FLAT LINE



CDJQ8 BN

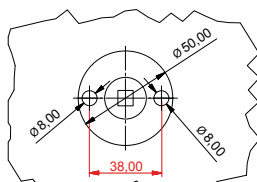
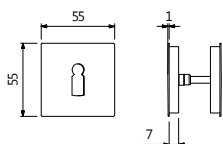

Metal



SISTEMA DI MONTAGGIO STANDARD
STANDARD MOUNTING SYSTEM



Finiture
Finishes

ZCR
ZSC

SNV

PVD INOX

BOCCHETTE FLAT LINE

000 CD JQ82B Set 2 bocchette quadre flat line
Set 2 square flat roses for key



Detrazione per articoli senza bocchetta CDJQ8
Deduction for items without rose for key CDJQ8

€

€

€

•

•

•

•

•

art. CDJQ8 BY



FLAT LINE



CDJQ8 BY

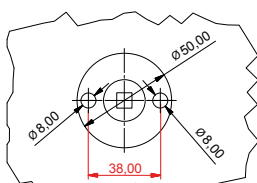
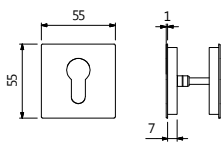

Metal



SISTEMA DI MONTAGGIO STANDARD
STANDARD MOUNTING SYSTEM



Finiture
Finishes

ZSC
ZCR

SNV

PVD INOX

BOCCHETTE YALE FLAT LINE

000 CD JQ82Y Set 2 bocchette quadre YALE flat line
Set 2 square flat roses for euro profile cylinder hole (YALE)

€

€

€

•

•

•

art. QD8 BN



QD8 BN

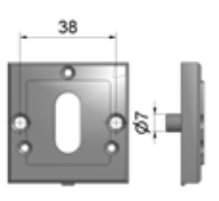
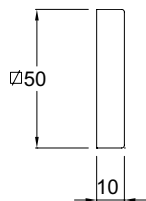

nylon



SISTEMA DI MONTAGGIO STANDARD
STANDARD MOUNTING SYSTEM



Finiture
Finishes

LV

OSC
OC

BOCCHETTA QUADRATA MM 50X10

QD8 BN Bocchetta coprivite quadrata con bussole
Square cover screw rose for key with bushes

	LV	OSC OC
€	€	€
	•	•

art. QD8 BY



QD8 BY

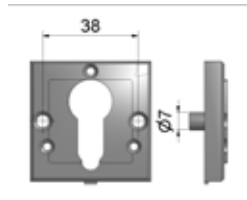
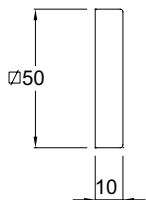

nylon



SISTEMA DI MONTAGGIO STANDARD
STANDARD MOUNTING SYSTEM



Finiture
Finishes

LV

OSC
OC

BOCCHETTA QUADRATA MM 50X10 YALE

QD8 BY Bocchetta coprivite quadrata foro yale
Square Cover screw rose for euro profile cylinder hole (yale) with bushes

	LV	OSC OC
€	€	€
	•	•

art. QN6 BN



QN6 BN*

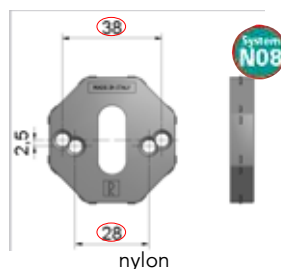
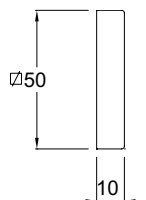

nylon



SISTEMA DI MONTAGGIO STANDARD
STANDARD MOUNTING SYSTEM



SISTEMA DI MONTAGGIO A RICHIESTA
ON REQUEST MOUNTING SYSTEM



* Fori viti adatti alle viti passanti - INTERASSE mm 30 e 38
Screws-holes suitable for door through screws centre to centre mm 30 and 38

BOCCHETTA QUADRATA MM 50X10

QN6 BN* Bocchetta coprivite quadrata
Square cover screw rose for key

art.026 KP

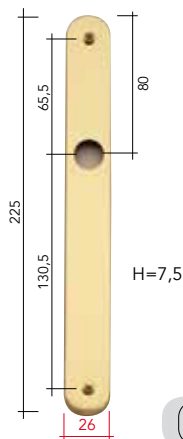

PLACCA PER MANIGLIA / PLATE FOR LEVER HANDLE

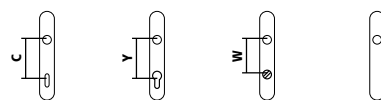

	C	Y	W	
	70	70	/	•
	72	72		
	75	85		
	90	88		
		90		
		92		

PLACCA SPECIALE PER PROFILI STRETTI / SPECIAL PLATE FOR NARROW PROFILES

Adattabile ad ogni impugnatura / Suitable for every lever handles



SISTEMA DI MONTAGGIO STANDARD
STANDARD MOUNTING SYSTEM



art.037 KP

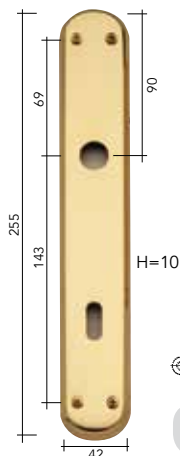

PLACCA PER MANIGLIA / PLATE FOR LEVER HANDLE

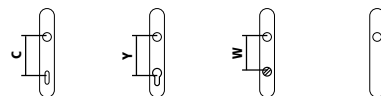

	C	Y	W	
	70	70	70	•
	72	72	72	
	75	85	78	
	90	88	85	
		90	90	
		92		



Placca adatta ad applicazione molla di ritorno (anche ambidestra con un extra di € 1,61 ogni coppia di maniglia)
Plate suitable to insert returning spring (also bidirectional with extra price of € 1,61 every pair lever handle)



SISTEMA DI MONTAGGIO STANDARD
STANDARD MOUNTING SYSTEM



art.037 KP



PLACCA SPECIALE

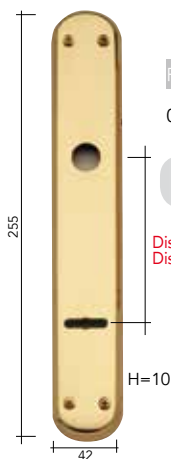

PLACCA PER MANIGLIA CON FORO DOPPIA MAPPA

037 KP *** Placca per maniglia con foro doppia mappa
Placca for lever handle with key hole for safety



	LV BG	OSC OC
	€	€
	•	•



SISTEMA DI MONTAGGIO STANDARD
STANDARD MOUNTING SYSTEM



Distanza da specificare
Distance to be specified



Placca adatta ad applicazione molla di ritorno (anche ambidestra con un extra di € 1,61 ogni coppia di maniglia)
Plate suitable to insert returning spring (also bidirectional with extra price of € 1,61 every pair lever handle)

art.039 KP

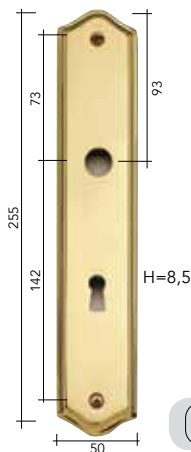

PLACCA PER MANIGLIA / PLATE FOR LEVER HANDLE

	C	Y	W	
	70	70	70	•
	72	72	72	
	75	85	78	
	90	88	85	
		90	90	
		92		

Placca adatta ad applicazione molla di ritorno
Plate suitable to insert returning spring



SISTEMA DI MONTAGGIO STANDARD
STANDARD MOUNTING SYSTEM



art.040 KP

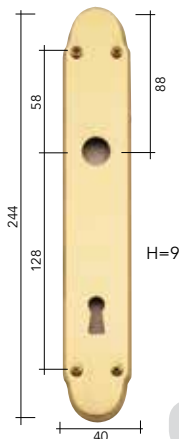

PLACCA PER MANIGLIA / PLATE FOR LEVER HANDLE

	C	Y	W	
	70	70	70	•
	72	72	72	
	75	85	78	
	90	88	85	
		90	90	
		92		

Placca adatta ad applicazione molla di ritorno
Plate suitable to insert returning spring



SISTEMA DI MONTAGGIO STANDARD
STANDARD MOUNTING SYSTEM



art.049 KP

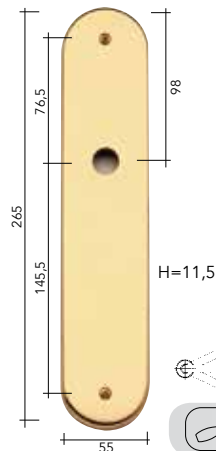

PLACCA PER MANIGLIA / PLATE FOR LEVER HANDLE

	C	Y	W	
	70	70	70	•
	72	72	72	
	75	85	78	
	90	88	85	
		90	90	
		92		



Placca adatta ad applicazione molla di ritorno (anche ambidestra con un extra di € 1,61 ogni coppia di maniglia)
Plate suitable to insert returning spring (also bidirectional with extra price of € 1,61 every pair lever handle)



SISTEMA DI MONTAGGIO STANDARD
STANDARD MOUNTING SYSTEM



SISTEMA DI MONTAGGIO A RICHIESTA
ON REQUEST MOUNTING SYSTEM



art.066 KP

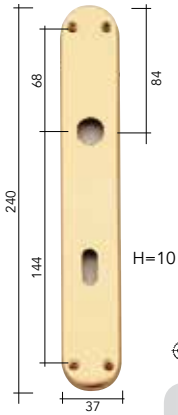

PLACCA PER MANIGLIA / PLATE FOR LEVER HANDLE

	C	Y	W	
	70	70	70	•
	72	72	72	
	75	85	78	
	90	88	85	
		90	90	
		92		



Placca adatta ad applicazione molla di ritorno (anche ambidestra con un extra di € 1,61 ogni coppia di maniglia)
 Plate suitable to insert returning spring (also bidirectional with extra price of € 1,61 every pair lever handle)

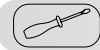

SISTEMA DI MONTAGGIO STANDARD
 STANDARD MOUNTING SYSTEM



art.101 KP

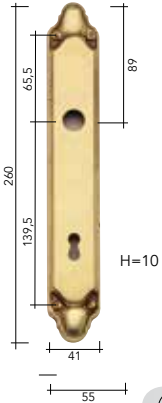

PLACCA PER MANIGLIA / PLATE FOR LEVER HANDLE

	C	Y	W	
	70	70	70	•
	72	72	72	
	75	85	78	
	90	88	85	
		90	90	
		92		

Placca adatta ad applicazione molla di ritorno
 Plate suitable to insert returning spring



SISTEMA DI MONTAGGIO STANDARD
 STANDARD MOUNTING SYSTEM



art.130 KP

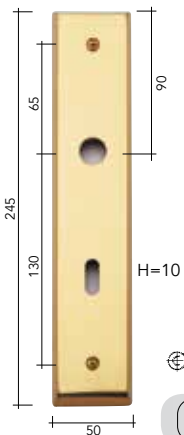

PLACCA PER MANIGLIA / PLATE FOR LEVER HANDLE

	C	Y	W	
	70	70	70	•
	72	72	72	
	75	85	78	
	90	88	85	
		90	90	
		92		



Placca adatta ad applicazione molla di ritorno (anche ambidestra con un extra di € 1,61 ogni coppia di maniglia)
 Plate suitable to insert returning spring (also bidirectional with extra price of € 1,61 every pair lever handle)

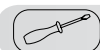

SISTEMA DI MONTAGGIO STANDARD
 STANDARD MOUNTING SYSTEM



SISTEMA DI MONTAGGIO A RICHIESTA
 ON REQUEST MOUNTING SYSTEM



art.130 KP



PLACCA SPECIALE

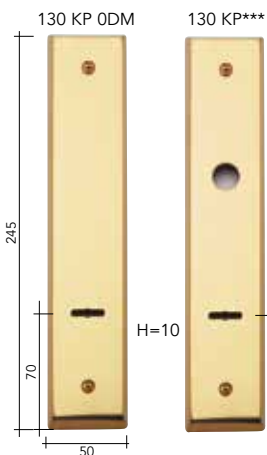

Distanza da specificare
Distance to be specified

PLACCA PER MANIGLIA CON FORO DOPPIA MAPPA	LV BG	OSC OC
---	----------	-----------

130 KP ODM	Placca cieca con solo foro doppia mappa <i>Blind plate with only key hole for safety</i>	•	•
130 KP***	Placca per maniglia con foro doppia mappa <i>Plate for lever handle with key hole for safety</i>	•	•



SISTEMA DI MONTAGGIO STANDARD
STANDARD MOUNTING SYSTEM



Placca adatta ad applicazione molla di ritorno (anche ambidestra con un extra di € 1,61 ogni coppia di maniglia)
Plate suitable to insert returning spring (also bidirectional with extra price of € 1,61 every pair lever handle)

art.P30 KP



PLACCA SPECIALE

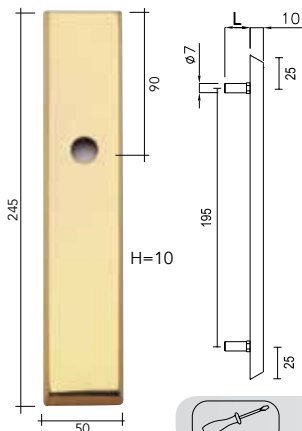

Placca cieca senza fori viti, con 2 bussole filettate
Plate without screws holes, with 2 threaded bushes

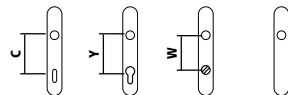

PLACCA PER MANIGLIA / PLATE FOR LEVER HANDLE	C	Y	W	
--	---	---	---	--

L	
M4	25
M5	19



particolare del sistema viti passanti
Bolt through screws system

70	70	70	•
72	72	72	
75	85	78	
90	88	85	
	90	90	
	92		



Placca adatta ad applicazione molla di ritorno (anche ambidestra con un extra di € 1,61 ogni coppia di maniglia)
Plate suitable to insert returning spring (also bidirectional with extra price of € 1,61 every pair lever handle)



SISTEMA DI MONTAGGIO STANDARD
STANDARD MOUNTING SYSTEM



art.159 KP

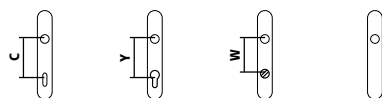
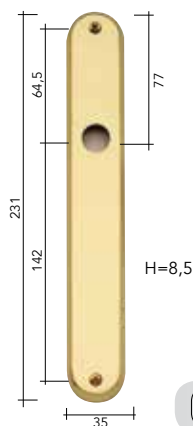

PLACCA PER MANIGLIA / PLATE FOR LEVER HANDLE	C	Y	W	
--	---	---	---	--

70	70	70	•
72	72	72	
75	85	78	
90	88	85	
	90	90	
	92		

Placca adatta ad applicazione molla di ritorno
Plate suitable to insert returning spring

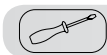

SISTEMA DI MONTAGGIO STANDARD
STANDARD MOUNTING SYSTEM



art.166 KP

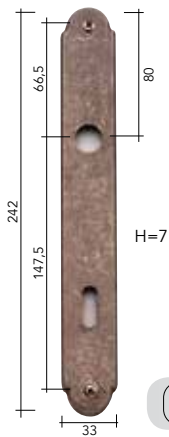

PLACCA PER MANIGLIA / PLATE FOR LEVER HANDLE

	C	Y	W	
	70	70	70	•
	72	72	72	
	90	85	78	
		88	85	
		90	90	

Placca adatta ad applicazione molla di ritorno
Plate suitable to insert returning spring



SISTEMA DI MONTAGGIO STANDARD
STANDARD MOUNTING SYSTEM



art.171 KP



NUOVA PLACCA PER PORTE BLINDATE

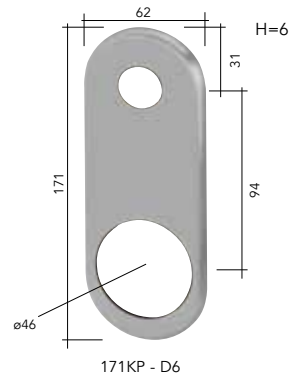
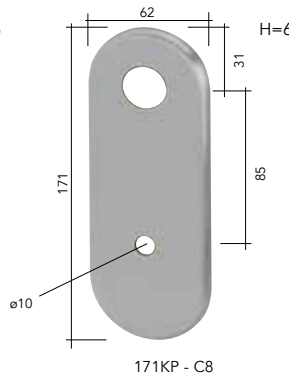
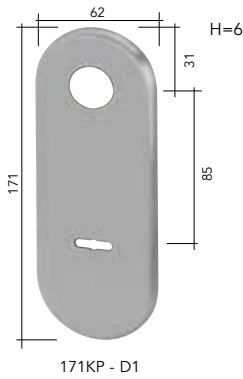
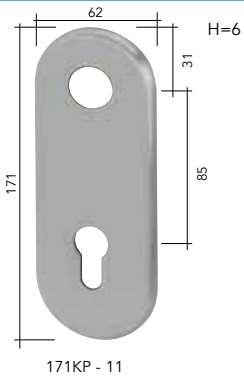

Placca adatta ad applicazione molla di ritorno - Plate suitable to insert returning spring



SISTEMA DI MONTAGGIO STANDARD
STANDARD MOUNTING SYSTEM



art.186 KP

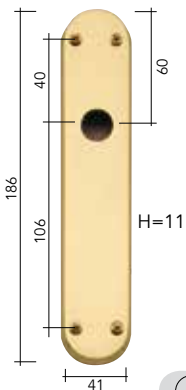

PLACCA PER MANIGLIA / PLATE FOR LEVER HANDLE

	C	Y	W	
	70	57	57	•
	72	70	70	
		72	90	

Placca adatta ad applicazione molla di ritorno
Plate suitable to insert returning spring



SISTEMA DI MONTAGGIO STANDARD
STANDARD MOUNTING SYSTEM



art.188 KP

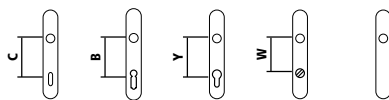
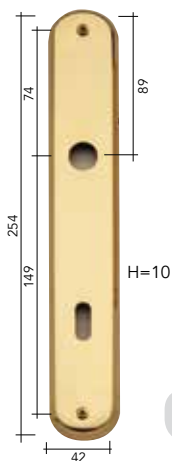

PLACCA PER MANIGLIA / PLATE FOR LEVER HANDLE	C	B	Y	W	
	70	70	70	70	•
	72	90	72	72	
	75		85	78	
	90		88	85	
			90	90	
			92		



Placca adatta ad applicazione molla di ritorno (anche ambidestra con un extra di € 1,61 ogni coppia di maniglia)
 Plate suitable to insert returning spring (also bidirectional with extra price of € 1,61 every pair lever handle)



SISTEMA DI MONTAGGIO STANDARD
 STANDARD MOUNTING SYSTEM



SISTEMA DI MONTAGGIO A RICHIESTA
 ON REQUEST MOUNTING SYSTEM



art.188 KP



PLACCA SPECIALE

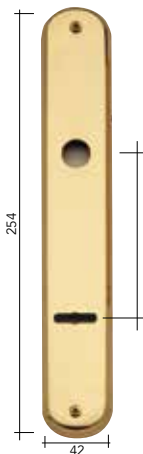

Distanza da specificare
 Distance to be specified



PLACCA PER MANIGLIA CON FORO DOPPIA MAPPA	LV BG	OSC OC
188 KP*** Placca per maniglia con foro doppia mappa Plate for lever handle with key hole for safety	•	•

Placca adatta ad applicazione molla di ritorno
 Plate suitable to insert returning spring



SISTEMA DI MONTAGGIO STANDARD
 STANDARD MOUNTING SYSTEM



Placca speciale: A richiesta può essere montata su ogni nostra impugnatura
 On request can be mounted on every our lever

art.P88 KP



PLACCA SPECIALE

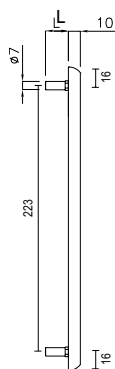
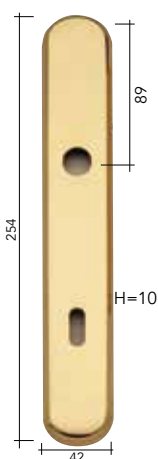

Placca cieca senza fori viti, con 2 bussole filettate
 Plate without screws holes, with 2 threaded bushes

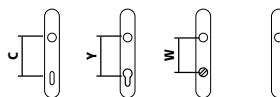

PLACCA PER MANIGLIA / PLATE FOR LEVER HANDLE	C	Y	W	
	70	70	70	•
	72	72	72	
	75	85	78	
	90	88	85	
		90	90	
		92		

L	
M4	25
M5	19



SISTEMA DI MONTAGGIO STANDARD
 STANDARD MOUNTING SYSTEM



art. 198

KP



Placca per linea *Elementia*

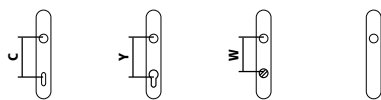

PLACCA PER MANIGLIA / PLATE FOR LEVER HANDLE

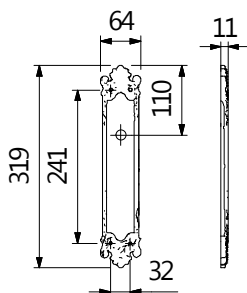

C	Y	W	
70	70	70	•
72	72	72	
75	85	78	
90	88	85	
	90	90	
	92	96	

198 KP - BGO

Adattabile ad ogni nostra impugnatura o pomolo / Suitable for every lever handles or knob



SISTEMA DI MONTAGGIO STANDARD
STANDARD MOUNTING SYSTEM



198 KP PLACCA PER MANIGLIA
PLATE FOR LEVER HANDLE

EXTRA PREZZO PER MANIGLIE CON PLACCA 198 EURO 22,50 RISPETTO ALLE MANIGLIE CON PLACCA 039
EXTRA PRICE FOR LEVERS ON PLATE 198 EURO 22,50 FROM PRICE OF LEVERS ON PLATE 039



art. 920

KP



Nuova placca per HOTEL

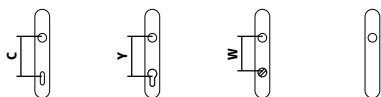

PLACCA PER MANIGLIA / PLATE FOR LEVER HANDLE

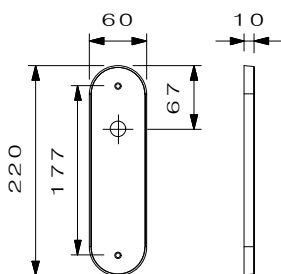

C	Y	W	
70	70	70	•
72	72	72	
75	85	78	
90	88	85	
	90	90	
	92	96	

920 KP - OSC

Adattabile ad ogni nostra impugnatura o pomolo / Suitable for every lever handles or knob



SISTEMA DI MONTAGGIO STANDARD
STANDARD MOUNTING SYSTEM



SISTEMA DI MONTAGGIO A RICHIESTA
ON REQUEST MOUNTING SYSTEM



920 KP PLACCA PER MANIGLIA
PLATE FOR LEVER HANDLE

PREZZO PER MANIGLIE CON PLACCA 920, UGUALE A MANIGLIE CON PLACCA 049
PRICE FOR LEVERS ON PLATE 920, THE SAME AS LEVERS ON PLATE 049

art.210 KP

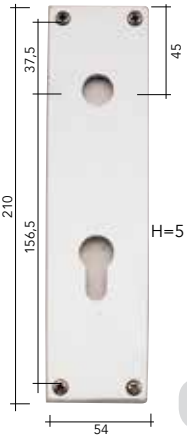

PLACCA PER MANIGLIA / PLATE FOR LEVER HANDLE

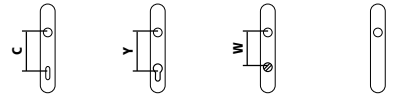

	C	Y	W	
	70	70	70	•
	72	72	72	
	90	85	78	
		88	85	
		90	90	

Placca adatta ad applicazione molla di ritorno
Plate suitable to insert returning spring



SISTEMA DI MONTAGGIO STANDARD
STANDARD MOUNTING SYSTEM



art.248 KP

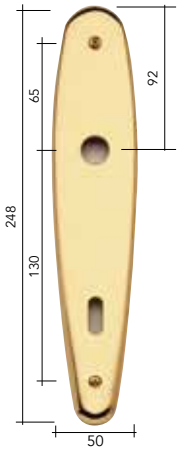

PLACCA PER MANIGLIA / PLATE FOR LEVER HANDLE

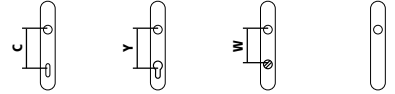

	C	Y	W	
	70	70	70	•
	72	72	72	
	75	85	78	
	90	88	85	
		90	90	

Placca adatta ad applicazione molla di ritorno
Plate suitable to insert returning spring



SISTEMA DI MONTAGGIO STANDARD
STANDARD MOUNTING SYSTEM



SISTEMA DI MONTAGGIO A RICHIESTA
ON REQUEST MOUNTING SYSTEM



art.P48 KP



PLACCA SPECIALE

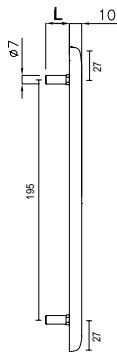
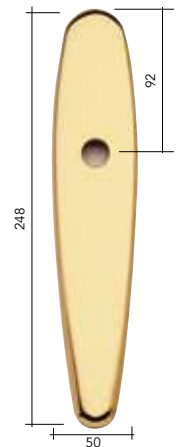

Placca cieca senza fori viti, con 2 bussole filettate
Plate without screws holes, with 2 threaded bushes

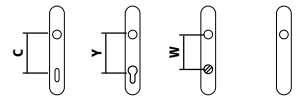

PLACCA PER MANIGLIA / PLATE FOR LEVER HANDLE

	C	Y	W	
	70	70	70	•
	72	72	72	
	75	85	78	
	90	88	85	
		90	90	
		92		

L	
M4	25
M5	19



Placca adatta ad applicazione molla di ritorno
Plate suitable to insert returning spring



SISTEMA DI MONTAGGIO STANDARD
STANDARD MOUNTING SYSTEM



art.224

KP



Placca per maniglia in Zama
Zamak plate for lever handle

TeKnoMetal
zamac line

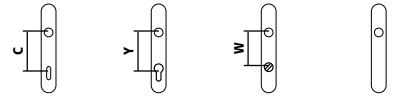
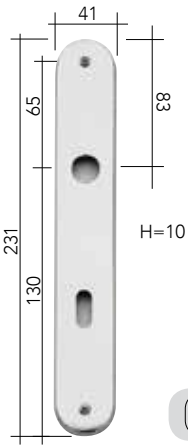

PLACCA PER MANIGLIA / PLATE FOR LEVER HANDLE

	C	Y	W	
	70	70	70	•
	72	72	72	
	90	85	78	
		88	85	
		90	90	
		92		

Placca adatta ad applicazione molla di ritorno
Plate suitable to insert returning spring



SISTEMA DI MONTAGGIO STANDARD
STANDARD MOUNTING SYSTEM



art.265

KP

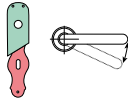

PLACCA SPECIALE PER SOSTITUZIONE
SPECIAL PLATE FOR SUBSTITUTION

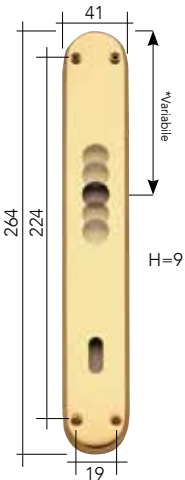

*Con molla in qualsiasi posizione
Posizione standard, se non diversamente specificato,
mm 106

*With returning spring in any position
Standard position, if not specified, 106 mm



PLACCA PER MANIGLIA / PLATE FOR LEVER HANDLE

	C	Y	W	
	70	70	70	•
	72	72	72	
	75	85	78	
	90	88	85	
		90	90	
		92	96	

Adattabile ad ogni impugnatura / Suitable for every lever handles



SISTEMA DI MONTAGGIO STANDARD
STANDARD MOUNTING SYSTEM



art.265

KP



PLACCA SPECIALE PER SOSTITUZIONE
SPECIAL PLATE FOR SUBSTITUTION

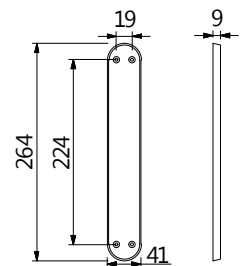
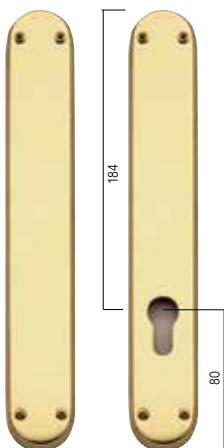

SISTEMA DI MONTAGGIO STANDARD
STANDARD MOUNTING SYSTEM



Finiture
Finishes

LV
BG

OC
OSC

PLACCA PER MANIGLIA / PLATE FOR LEVER HANDLE

265 KP ***00

Placca cieca con solo 4fori viti
Blind plate with 4screwholes only

265 KP 00Y

Placca con solo foro yale e 4fori viti
Plate only with yale hole and with 4screwholes



art. Q65 KP

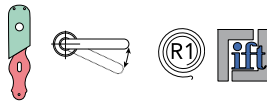

PLACCA SPECIALE PER SOSTITUZIONE
SPECIAL PLATE FOR SUBSTITUTION

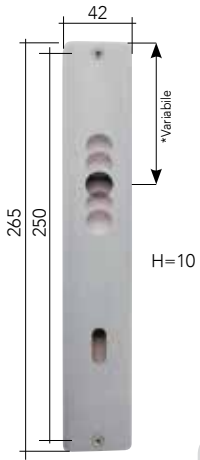

*Con molla in qualsiasi posizione
Posizione standard, se non diversamente
specificato, mm 106

*With returning spring in any position
Standard position, if not specified, 106 mm

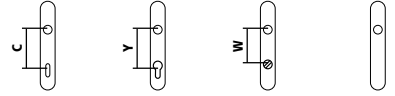

PLACCA PER MANIGLIA / PLATE FOR LEVER HANDLE

C	Y	M	
70	70	70	•
72	72	72	
75	85	78	
90	88	85	
	90	90	
	92	96	

Adattabile ad ogni impugnatura
Suitable for every lever handles

Solo a richiesta, prezzi e quantità da definire
On request only, and for quantity to be finalized



SISTEMA DI MONTAGGIO STANDARD
STANDARD MOUNTING SYSTEM



art. Q65 KP



PLACCA SPECIALE PER SOSTITUZIONE
SPECIAL PLATE FOR SUBSTITUTION

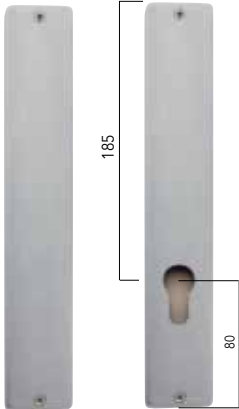

Q65 KP *** - OSC Q65 KP 00Y - OSC

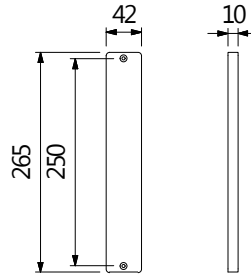

SISTEMA DI MONTAGGIO STANDARD
STANDARD MOUNTING SYSTEM



Solo a richiesta, prezzi e quantità da definire
On request only, and for quantity to be finalized

A RICHIESTA può essere montata su ogni nostro articolo / On REQUEST can be mounted on every our item
Placca adatta a movimenti intercambiabili M2 (a-b)* / plate suitable to interchangeable movements M2 (a-b)*
Placca adattabile con spessore a movimenti M1 per DK (c-d) / plate suitable to M1 movements for Dreh Kipp (c-d)

Esempi di applicazione:

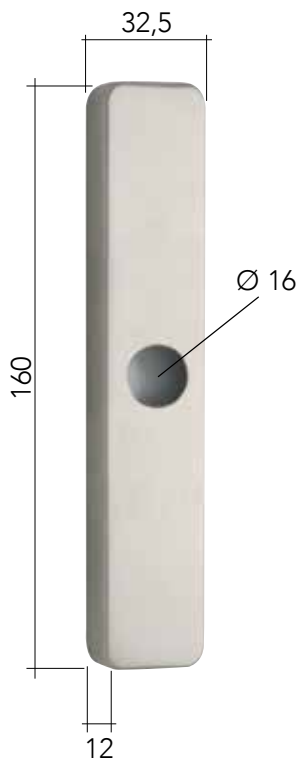

a) Cremonese / Martellina
impugnatura a T

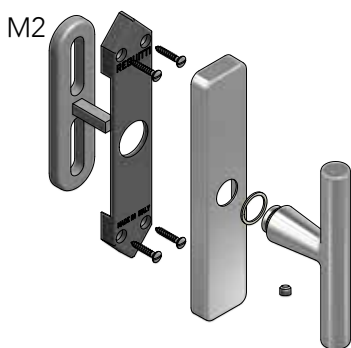

b) Cremonese \ Segretino
con gioco, impugnatura a maniglia

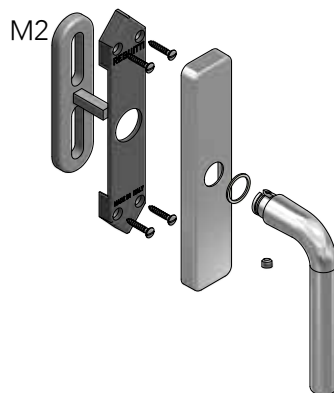

c) TK

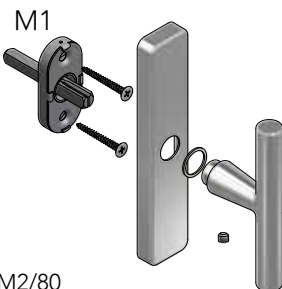

d) DK

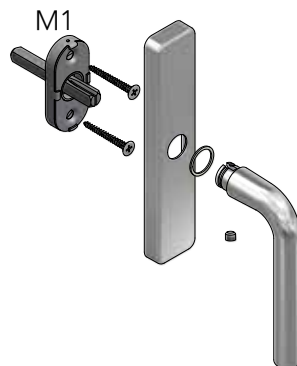

* esclusi movimenti M2/73 - M2/74 - M2/80
not suitable for mechanism M2/73 - M2/74 - M2/80

Esempio:
...CR070



...CRQ13

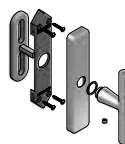

Esempio:
...DK015



...DKQ13

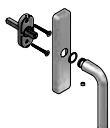

Esempio:
...DKQ15



...DKQ13

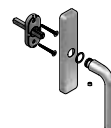



A RICHIESTA può essere montata su ogni nostro articolo / On REQUEST can be mounted on every our item
Placca adatta a movimenti intercambiabili M3 (a-b) / plate suitable to interchangeable movements M3 (a-b)
Placca adattabile con spessore a movimenti M1 per DK (c-d) / plate suitable to M1 movements for Dreh Kipp (c-d)

Esempi di applicazione:

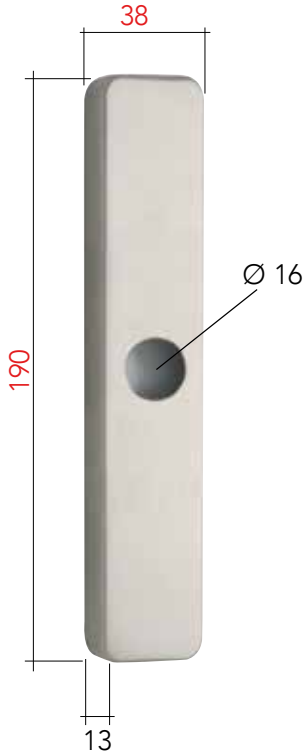

a) Cremonese / Martellina
impugnatura a T

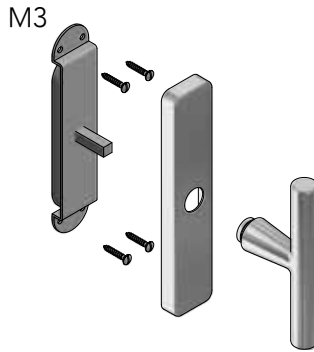

b) Cremonese \ Segretino
con gioco, impugnatura a maniglia

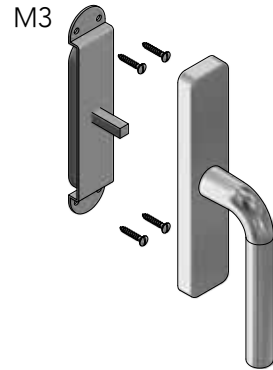

c) TK

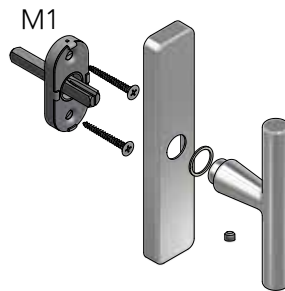

d) DK

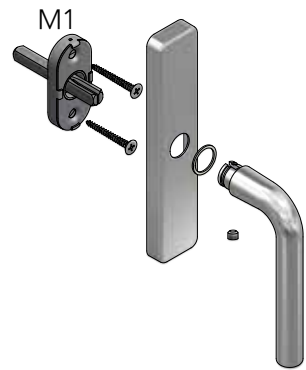

Esempio:
...CR070

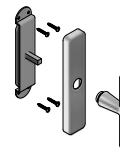

...CRQ90



Esempio:
...DK015

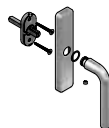

...DKQ90

Esempio:
...DKQ15

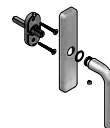

...DKQ90

art.36 KM/KC

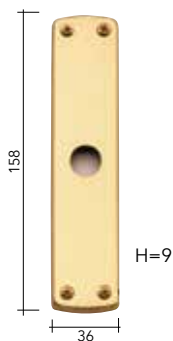

PLACCA PER CREMONESE O MARTELLINA / PLATE FOR LEVER HANDLE



SISTEMA DI MONTAGGIO STANDARD
STANDARD MOUNTING SYSTEM



art.40 KM/KC

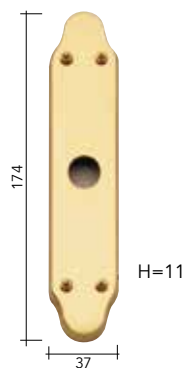

PLACCA PER CREMONESE O MARTELLINA / PLATE FOR LEVER HANDLE



SISTEMA DI MONTAGGIO STANDARD
STANDARD MOUNTING SYSTEM



Placca adatta ai movimenti intercambiabili
Plate suitable to interchangeable movement

art.63 KC

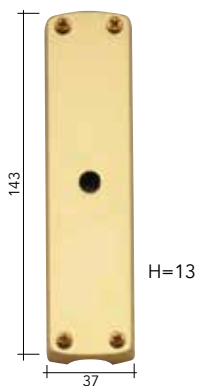

PLACCA PER CREMONESE CON G.MP PER ASTE ESTERNE / PLATE FOR WINDOW HANDLE G.MP FOR OUTSIDE RODS



SISTEMA DI MONTAGGIO STANDARD
STANDARD MOUNTING SYSTEM



PLACCA SPECIALE
SPECIAL PLATE

Adattabile ad ogni impugnatura / Suitable for all our handle



Esempio di applicazione
Mounting Example

art.070 KM

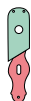

PLACCA SPECIALE PER SOSTITUZIONE SPECIAL PLATE FOR SUBSTITUTION

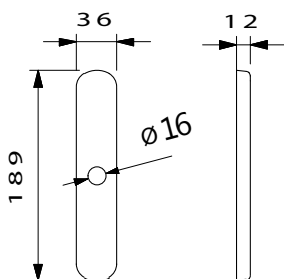

Placca per cremonese o Martellina
Plate for window handles

Dimensione maggiorata per coprire i segni preesistenti
Dimension oversized to cover the signs of pre-existing

Adattabile ad ogni impugnatura
Suitable for every lever handles

Placca adatta a movimenti intercambiabili
Plate suitable to interchangeable movements



SISTEMA DI MONTAGGIO STANDARD
STANDARD MOUNTING SYSTEM



Adattabile ad ogni impugnatura / Suitable for every lever handles

art.101 KM/KC

PLACCA PER CREMONESE O MARTELLINA / PLATE FOR LEVER HANDLE



SISTEMA DI MONTAGGIO STANDARD
STANDARD MOUNTING SYSTEM



PLACCA PER CREMONESE O MARTELLINA / PLATE FOR LEVER HANDLE

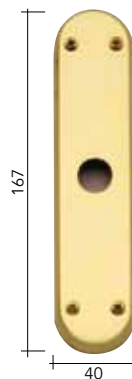

SISTEMA DI MONTAGGIO STANDARD
STANDARD MOUNTING SYSTEM



Placca adatta ai movimenti intercambiabili
Plate suitable to interchangeable movement

art. 160 KM

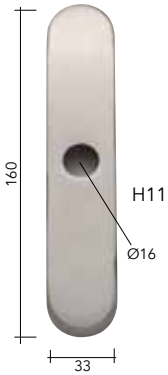

PLACCA COPRIVITI PER CREMONESE O MARTELLINA / COVER SCREW PLATE FOR WINDOW HANDLE

Placca adatta ai movimenti intercambiabili
Plate suitable to interchangeable movements

A richiesta può essere montata su ogni nostro articolo in acciaio inox
On request can be mounted on every our stainless steel item

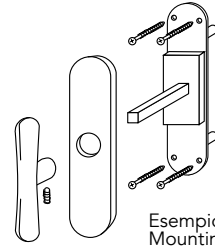

Esempio di applicazione
Mounting Example



SISTEMA DI MONTAGGIO STANDARD
STANDARD MOUNTING SYSTEM



art. 189 KM



PLACCA SPECIALE PER SOSTITUZIONE SPECIAL PLATE FOR SUBSTITUTION

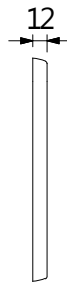
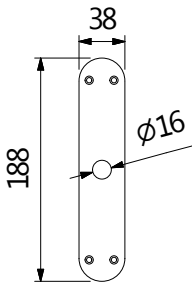

Placca per cremonese o Martellina
Plate for window handles

Dimensione maggiorata per coprire i segni preesistenti
Dimension oversized to cover the signs of pre-existing

Adattabile ad ogni impugnatura
Suitable for every lever handles

Placca adatta a movimenti intercambiabili
Plate suitable to interchangeable movements



SISTEMA DI MONTAGGIO STANDARD
STANDARD MOUNTING SYSTEM



Adattabile ad ogni impugnatura / Suitable for every lever handles

art. Q90 KM

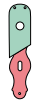

PLACCA SPECIALE PER SOSTITUZIONE SPECIAL PLATE FOR SUBSTITUTION

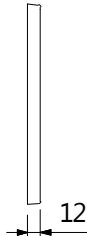
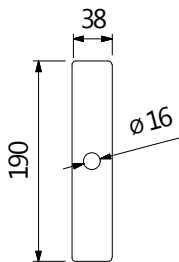

Placca coprivite per cremonese o Martellina
Cover screw plate for window handles

Dimensione maggiorata per coprire i segni preesistenti
Dimension oversized to cover the signs of pre-existing

Adattabile ad ogni impugnatura
Suitable for every lever handles

Placca adatta a movimenti intercambiabili
Plate suitable to interchangeable movements



SISTEMA DI MONTAGGIO STANDARD
STANDARD MOUNTING SYSTEM



Adattabile ad ogni impugnatura / Suitable for every lever handles

art.Q13 KT

PLACCA RETTANGOLARE CIECA

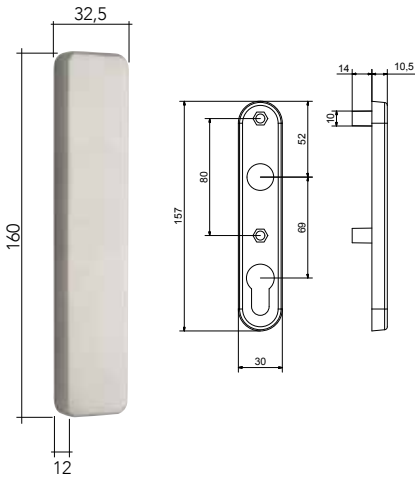

Finiture
Finishes

LV

OC
OSC

PLACCA CIECA / BLIND PLATE

Q13KT***00

Placca coprivite cieca
Blind cover screw plate

€

€



SISTEMA DI MONTAGGIO STANDARD
STANDARD MOUNTING SYSTEM



art.037 KT

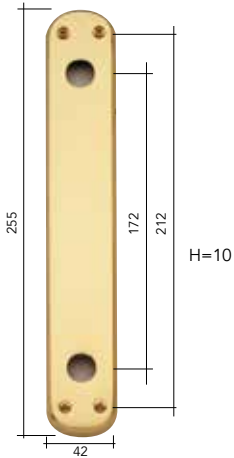

PLACCA PER MANIGLIONE / PLATE FOR PULL HANDLE



SISTEMA DI MONTAGGIO STANDARD
STANDARD MOUNTING SYSTEM



art.319 KT

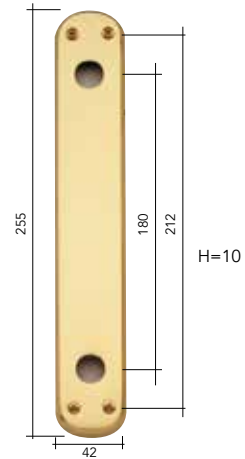

art.Y37 KT

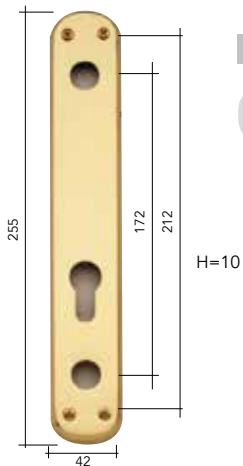

PLACCA PER MANIGLIONE CON FORO YALE / YALE PLATE FOR PULL HANDLE



SISTEMA DI MONTAGGIO STANDARD
STANDARD MOUNTING SYSTEM



art.40 KT

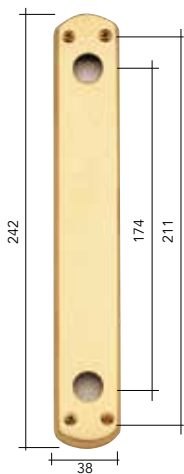

PLACCA PER MANIGLIONE / PLATE FOR PULL HANDLE



SISTEMA DI MONTAGGIO STANDARD
STANDARD MOUNTING SYSTEM



H=8,5

art.315 KT

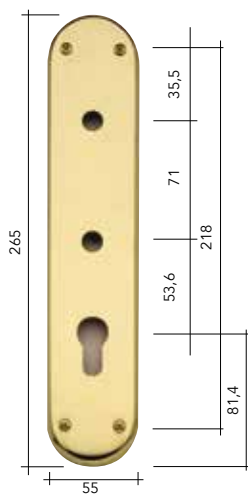

PLACCA PER MANIGLIONE CON FORO YALE / YALE PLATE FOR PULL HANDLE



SISTEMA DI MONTAGGIO STANDARD
STANDARD MOUNTING SYSTEM



H=11,5

art.316 KT

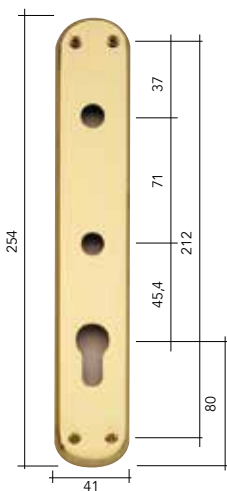

PLACCA PER MANIGLIONE CON FORO YALE / YALE PLATE FOR PULL HANDLE



SISTEMA DI MONTAGGIO STANDARD
STANDARD MOUNTING SYSTEM



H=10

ACCESSORI TECNICI e COMPONENTI

TECHNICAL COMPONENTS

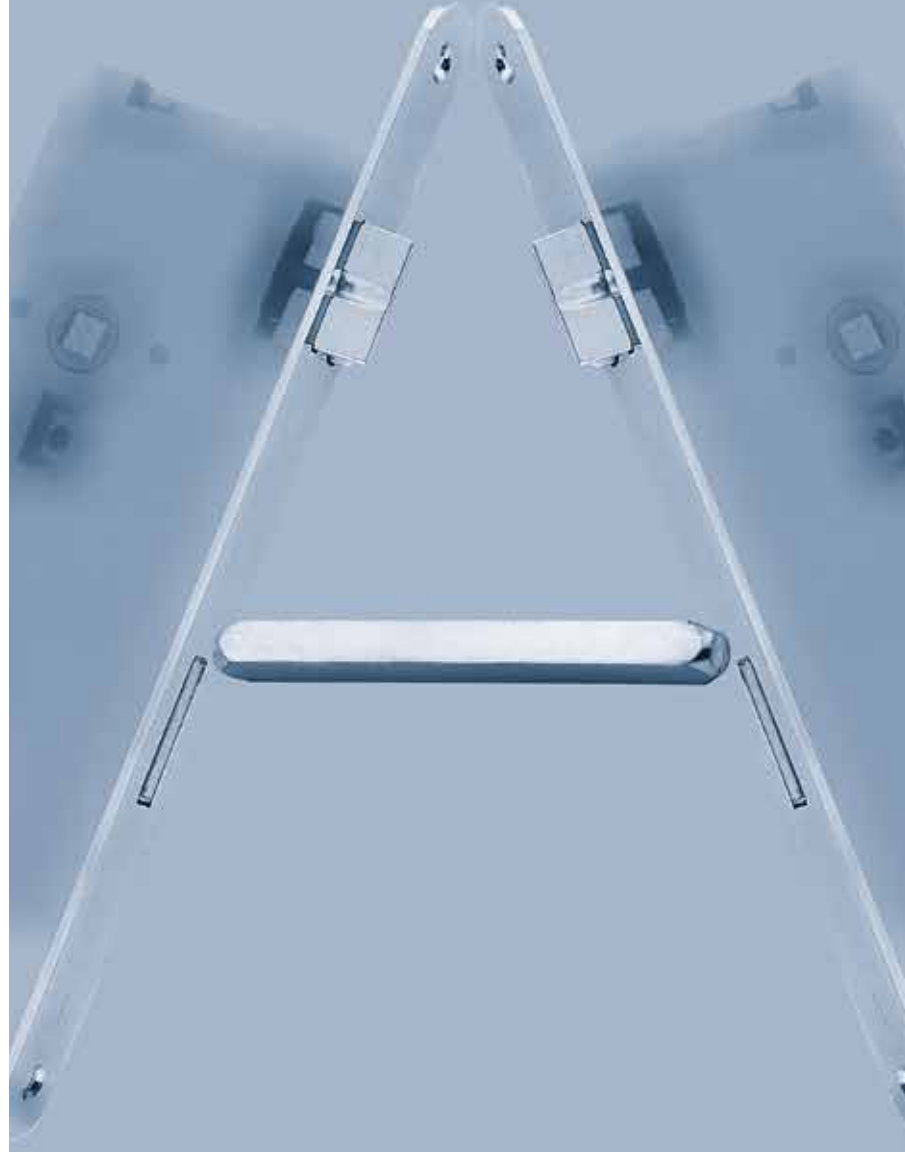

SET LOCK

QUALSIASI MANIGLIA PUO' ESSERE FORNITA IN SET CON SERRATURA
EVERY HANDLES CAN BE SUPPLIED IN LOCKSET



ESEMPIO / EXAMPLE

PREZZO DI LISTINO DELLA MANIGLIA PRICE OF LEVER HANDLE (SEE PRICE LIST)	€
SERRATURA YALE (P)40 - BORDO QUADRO LACCATO (1 SR) YALE LOCK - (P)40 - SQUARE EDGE - PAINTED (1 SR)	•
CILINDRO (1 CY 062) CYLINDER (1 CY 062)	•
CONFEZIONE SPECIALE SPECIAL PACKING	•
TOTALE EXTRA PER SET CON MANIGLIA FORO YALE + SERRATURA YALE (LACCATA) + CILINDRO TOTAL EXTRA FOR SET WITH HANDLE YALE + YALE LOCK + CYLINDER	•

art. 1CY062

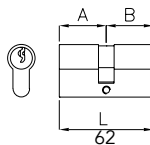

Grezzo	€
--------	---

1 CY 062 Cilindro yale mm 62 centrale - completo di tre chiavi
Yale cylinder mm 62 with three keys



Extra per confezione self-service in blister
Extra for self-service blister packing **1,21**

A RICHIESTA: POSSIBILITÀ DI AVERE ALTRE MISURE DI CILINDRI CENTRALI E DECENTRATI
ON REQUEST: OPPORTUNITY TO HAVE OTHER MEASURES OF CENTRAL AND DECENTRALIZED CYLINDERS

art. 1SR YALE

cromato
chrome



sat
crom



bronzato
bronzed



ott. brill.
bright brassed

FRONTALE / FRONT PLATE: mm 22
INTERASSE / DISTANCE: mm 85
QUADRO / SQUARE HOLE: mm 8
SCROCCO / LATCH: reversibile / reversible

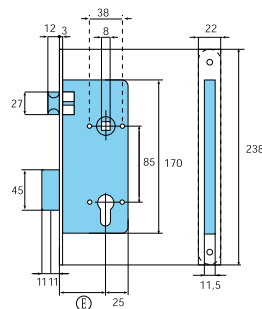

BORDO PIASTRA
FRONT PLATE

TIPO DI INCONTRO
STRIKING PLATE

ENTRATA
BACKSET

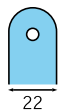

22

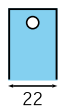

22

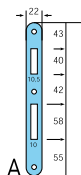

A

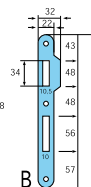

B

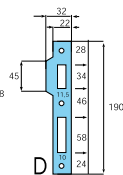

D

mm 40
mm 45
mm 50

2 mandate
2 turns



Laccato	Bronz	Ott. Brill.	OC	OSC
€	€	€	€	€

1 SR Serratura yale senza cilindro
Yale Lock without cylinder



Extra per confezione self-service in blister
Extra for self-service blister packing **2,95**

Articoli su richiesta

art. 8SR PATENT WC

cromato
chrome



sat crom



bronzato
bronzed



ott. brill.
bright brassed

FRONTALE / FRONT PLATE: mm 22
 INTERASSE / DISTANCE: mm 90*
 QUADRO / SQUARE HOLE: mm 8
 QUADRO CAT. / SQUARE HOLE: mm 6
 SCROCCO / LATCH: reversibile / reversible

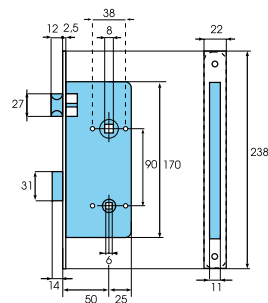

BORDO PIASTRA
FRONT PLATE

TIPO DI INCONTRO
STRIKING PLATE

ENTRATA
BACKSET

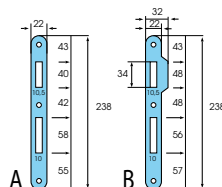
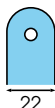

mm 40
 mm 45
 mm 50
 1 mandata
 1 turn

SERRATURA PATENT WC

8 SR

Serratura per wc - q.8 con q.6 dist. 90
 W.C. Lock - q.8 with q.6 distance 90



Extra per confezione self-service in blister
 Extra for self-service blister packing

2,95



Bronz	Ott. Brill.	OC	OSC	
€	€	€	€	
•	•	•	•	

Articoli su richiesta

art. 4SR PATENT GRANDE

cromato
chrome



sat crom



bronzato
bronzed



ott. brill.
bright brassed

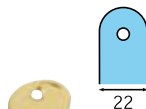

FRONTALE / FRONT PLATE: mm 22
 INTERASSE / DISTANCE: mm 90
 QUADRO / SQUARE HOLE: mm 8
 SCROCCO / LATCH: reversibile / reversible
 CIFRATURA / NUMERATION: assortita / assorted
 (a richiesta unica per industria)

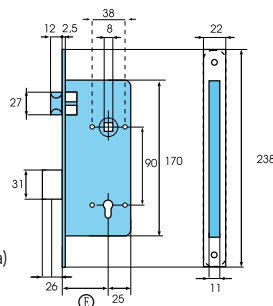

BORDO PIASTRA
FRONT PLATE

TIPO DI INCONTRO
STRIKING PLATE

ENTRATA
BACKSET

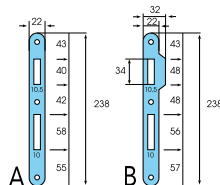

mm 40
 mm 45
 mm 50
 2 mandate
 2 turns

SERRATURA PATENT GRANDE DIST. 90

4 SR

Serratura patent q.8 dist. 90
 Patent Lock q.8 distance 90



Extra per confezione self-service in blister
 Extra for self-service blister packing

2,95



Bronz	Ott. Brill.	OC	OSC	
€	€	€	€	
•	•	•	•	

Articoli su richiesta

art. 4SR PATENT PICCOLA

FRONTALE / FRONT PLATE: mm 20
 INTERASSE / DISTANCE: mm 70
 QUADRO / SQUARE HOLE: mm 8
 SCROCCO / LATCH: reversibile / reversible
 CIFRATURA / NUMERATION: assortita / assorted
 (a richiesta unica per industria)

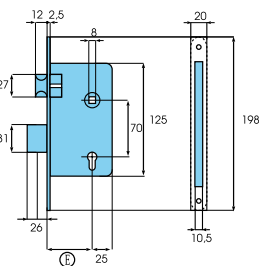

bronzato
bronzato

ott. brill.
bright
brassed



BORDO PIASTRA FRONT PLATE TIPO DI INCONTRO STRIKING PLATE ENTRATA BASKET

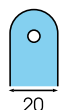

20

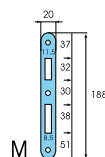

mm 40
mm 45
mm 50

2 mandate
2 turns

SERRATURA PATENT GRANDE DIST. 90

4 SR

Serratura patent q.8 dist. 70
Patent Lock q.8 distance 70



Extra per confezione self-service in blister
Extra for self-service blister packing

2,95



BRONZATO

OTTONE BRILLANTE



Articoli su richiesta

art. M4



MOVIMENTO PER CREMONESI - CON FORO CENTRALE Ø 7 - TIPO JOLLY

		€
M4/70	Movimento gratz con fori Ø6 Mechanism - gratz with holes Ø6	•
M4/71	Movimento gratz con bussole Ø10x7 Mechanism - gratz with bushes Ø10x7	•
M4/72	Movimento gratz con perni Ø6x17 Mechanism - gratz with pins Ø6x17	•
735 PE	Perno Q.7x35 con fresatura Square spindle Ø 7x35	•



M4/70



M4/71



M4/72



735 PE

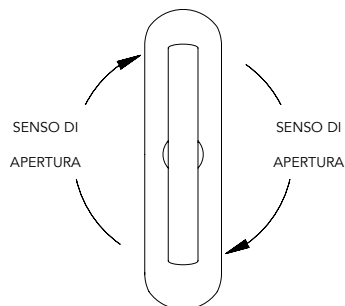
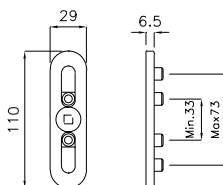

art. M3



M3/53



M3/81



M3/82*



M3/83



M3/84



M3/86



M3/87*



M3/88



M3/89

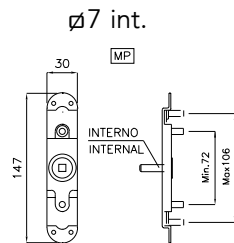
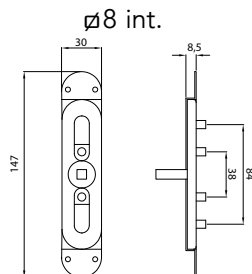
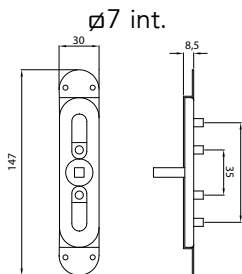

CON \varnothing 7
INTERNO €

CON \varnothing 8
INTERNO €

MOVIMENTO PER CREMONESI - PER PLACCHE COPRITTI

M3/53	Movimento per martelline con ferro \varnothing 7x45 <i>Mechanism with spindle \varnothing7x45</i>	•	•
M3/81	Movimento gratz con fori \varnothing 6 <i>Mechanism - gratz with holes \varnothing6</i>	•	
M3/82	Movimento gratz con bussole \varnothing 10x7 <i>Mechanism - gratz with bushes \varnothing10x7</i>	•*	•*
M3/83	Movimento gratz con perni \varnothing 6x17 <i>Mechanism - gratz with pins \varnothing6x17</i>	•	
M3/84	Movimento G.MP per aste interne perni \varnothing 6x18 <i>Mechanism G.MP internal rods with pins \varnothing6x18</i>	•	
M3/86	Movimento G. Centrale <i>Mechanism - central gratz</i>	•	
M3/87	Movimento gratz con bussole + \varnothing 7x45 <i>Mechanism - gratz with bushes and spindle \varnothing7x45</i>	•	•*
M3/88	Movimento gratz con perni + \varnothing 7x45 <i>Mechanism - gratz with pins and \varnothing7x45</i>	•	
M3/89	Movimento G.MP per aste interne + \varnothing 7x45 <i>Mechanism G.MP internal rods and spindle \varnothing7x45</i>	•	

Standard

*Possibile su richiesta senso di apertura in senso antiorario

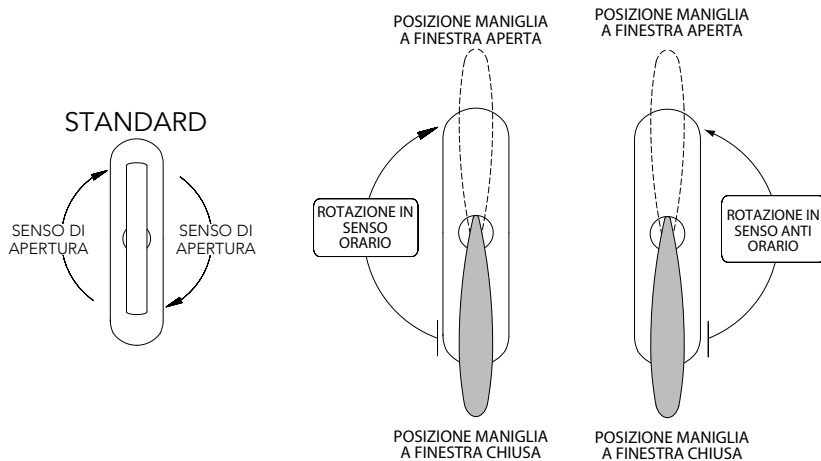

con $\varnothing 6$ int.

con $\varnothing 7$ int.

con $\varnothing 7$ int.

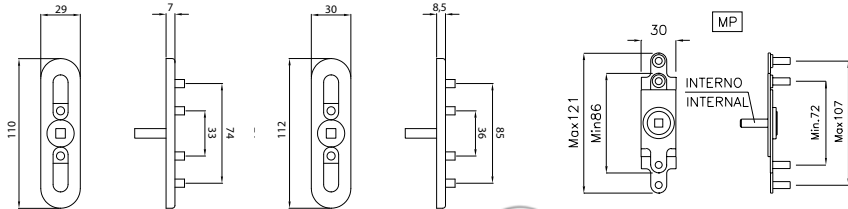

CON $\varnothing 6$
INTERNO €

CON $\varnothing 7$
INTERNO €

MOVIMENTO PER CREMONESI - PER PLACCHE CON FORI VITI IN VISTA

M2/53	Movimento $\varnothing 7 \times 45$ per martelline con placca Q13 <i>Mechanism with spindle $\varnothing 7 \times 45$ for Q13 plate</i>		•
M2/70	Movimento gratz con fori $\varnothing 6$ <i>Mechanism - gratz with holes $\varnothing 6$</i>	•	•
M2/71	Movimento gratz con bussole $\varnothing 10 \times 7$ <i>Mechanism - gratz with bushes $\varnothing 10 \times 7$</i>	•	•*
M2/72	Movimento gratz con perni $\varnothing 6 \times 17$ <i>Mechanism - gratz with pins $\varnothing 6 \times 17$</i>	•	•
M2/73	Movimento G.MP per aste interne perni $\varnothing 6 \times 15$ <i>Mechanism G.MP internal rods with pins $\varnothing 6 \times 15$</i>	•	•
M2/74	Movimento G.MP per aste esterne perni $\varnothing 6 \times 6$ <i>Mechanism G.MP for outside rods with pins $\varnothing 6 \times 6$</i>	•	•
M2/75Ⓢ	Movimento G. Laterale <i>Mechanism - Lateral</i>	•	•
M2/76Ⓢ	Movimento G. Centrale <i>Mechanism - central gratz</i>	•	•
M2/77	Movimento gratz con fori + $\varnothing 7 \times 40$ <i>Mechanism - gratz with holes and spindle $\varnothing 7 \times 40$</i>	•	•
M2/78	Movimento gratz con bussole + $\varnothing 7 \times 40$ <i>Mechanism - gratz with bushes and spindle $\varnothing 7 \times 40$</i>	•	•*
M2/79	Movimento gratz con perni + $\varnothing 7 \times 40$ <i>Mechanism - gratz with pins and $\varnothing 7 \times 40$</i>	•	•
M2/80	Movimento G.MP per aste interne + $\varnothing 7 \times 35$ <i>Mechanism G.MP internal rods and spindle $\varnothing 7 \times 35$</i>	•	•
BASM2Q13	Adattatore per placca coprivite Q13 <i>Adapter for cover screw Q13 plate</i>		•

SPECIFICARE / PLEASE SPECIFY:
SE IL FERRO QUADRO INTERNO DEVE ESSERE 6 O 7
IF INTERNAL SQUARE SPINDLE IS REQUESTED 6 OR 7

①

Standard

*Possibile su richiesta senso di apertura in senso antiorario

POSIZIONE MANIGLIA A FINESTRA APERTA

POSIZIONE MANIGLIA A FINESTRA APERTA

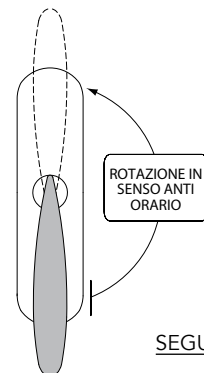
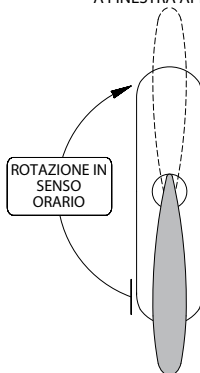

STANDARD

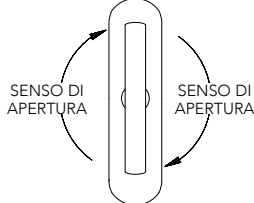

POSIZIONE MANIGLIA A FINESTRA CHIUSA

POSIZIONE MANIGLIA A FINESTRA CHIUSA

SEGUE M2 →

art. M2



BASM2Q13

Adattatore per movimento M2
su placca coprivite Q13

esclusi movimenti M2/73 - M2/74 - M2/80
not suitable for mechanism M2/73 - M2/74 - M2/80

PER
CR - MA

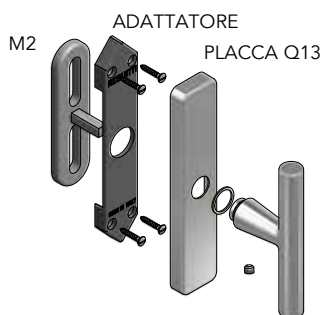

PER
SE - SG

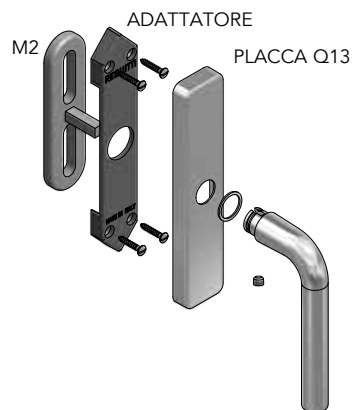

STANDARD

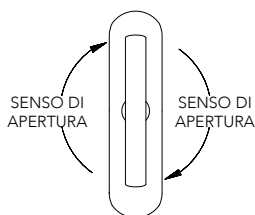

art. M5

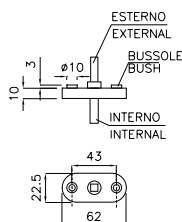

con bussole
with bushes
€

MOVIMENTO IN METALLO A 4 SCATTI PER D.K. / METAL MECHANISM WITH 4 RELEASES

M5	∅7 interno / ∅7x32 esterno ∅7 internal / ∅7x32 external	•
M5	∅7 interno / ∅7x40 esterno ∅7 internal / ∅7x40 external	•
M5	∅7 interno / ∅7x50 esterno ∅7 internal / ∅7x50 external	•
M5	∅7 interno / ∅7x60 esterno ∅7 internal / ∅7x60 external	•
M5	∅8 interno / ∅7x32 esterno ∅8 internal / ∅7x32 external	•
M5	∅8 interno / ∅7x40 esterno ∅8 internal / ∅7x40 external	•

Movimento speciale per profili stretti
Special mechanism for narrow profiles

Movimento adatto ad ogni nostra maniglia
Mechanism suitable for every lever handle



su rosetta 025
on rose 025

mm 25

SPECIFICARE / PLEASE SPECIFY:

1. SE IL FERRO QUADRO INTERNO DEVE ESSERE 7 O 8
IF INTERNAL SQUARE SPINDLE IS REQUESTED 7 OR 8
2. LA LUNGHEZZA DEL FERRO QUADRO 7 ESTERNO
LENGTH OF EXTERNAL SQUARE SPINDLE 7

art. M1 4 SCATTI



senza bussole
without bushes
€

con bussole
with bushes
€

MOVIMENTO IN METALLO A 4 SCATTI PER D.K. / METAL MECHANISM WITH 4 RELEASES

con bussole
with bushes



M1	∅7 interno / ∅7x32 esterno ∅7 internal / ∅7x32 external	•	•
M1	∅7 interno/ ∅7x42 esterno ∅7 internal/ ∅7x42 external		•
M1	∅7 interno/ ∅7x50 esterno ∅7 internal/ ∅7x50 external		•
M1	∅8 interno/ ∅7x32 esterno ∅8 internal/ ∅7x32 external	•	•
M1	∅8 interno/ ∅7x37 esterno ∅8 internal/ ∅7x37 external		•
M1	∅8 interno/ ∅7x42 esterno ∅8 internal/ ∅7x42 external	•	•
M1	∅8 interno/ ∅7x50 esterno ∅8 internal/ ∅7x50 external	•	•

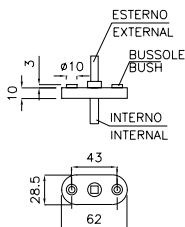

SPECIFICARE / PLEASE SPECIFY:

1. SE IL FERRO QUADRO INTERNO DEVE ESSERE 7 O 8
IF INTERNAL SQUARE SPINDLE IS REQUESTED 7 OR 8
2. LA LUNGHEZZA DEL FERRO QUADRO 7 ESTERNO
LENGTH OF EXTERNAL SQUARE SPINDLE 7
3. SE IL MOVIMENTO DEVE ESSERE CON O SENZA
BUSSOLE *IF MECHANISM IS REQUESTED WITH OR WITHOUT BUSHES*

art. M1 8 SCATTI



A RICHIESTA

movimenti a 8 scatti per
serramenti con **microventilazione**.

Adatto per tutti i nostri
DK015 - DKQ15 - DK075 e DKQ75
Fissaggio con grano

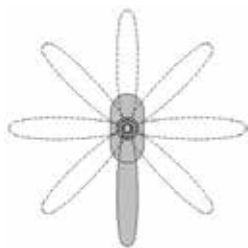
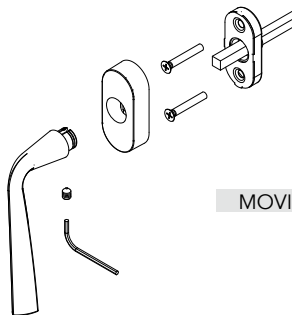

senza bussole
without bushes
€

con bussole
with bushes
€

MOVIMENTO IN METALLO A 8 SCATTI PER D.K. / METAL MECHANISM WITH 8 RELEASES

M1	∅8 interno / ∅7x35 esterno ∅8 internal / ∅7x35 external		•
M1	∅8 interno/ ∅7x42 esterno ∅8 internal/ ∅7x42 external		•
M1	∅8 interno/ ∅7x50 esterno ∅8 internal/ ∅7x50 external		•
M1	∅8 interno/ ∅7x57 esterno ∅8 internal/ ∅7x57 external	•	•
M1	∅8 interno/ ∅7x65 esterno ∅8 internal/ ∅7x65 external	•	•

art. M7

MOVIMENTO CON CHIAVE E CILINDRO KA STESSA CIFRATURA WITH CYLINDER AND KEY ALIKE SYSTEM WITH 1 KEY FOR CYLINDER (KA)



MOVIMENTO IN METALLO A 4 SCATTI PER D.K. - COMPLETO DI CILINDRO E CHIAVE / MECHANISM WITH 4 RELEASES WITH CYLINDER AND KEY

M7	☒ 8 interno/ ☒ 7x32 esternal ☒ 8 internal/ ☒ 7x32 external
M7	☒ 8 interno/ ☒ 7x42 esterno ☒ 8 internal/ ☒ 7x42 external

con bussole with bushes	•
	•

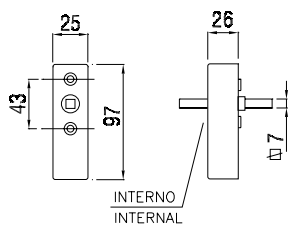

Movimento adatto ad ogni nostra maniglia
Mechanism suitable for every lever handle

SPECIFICARE LA LUNGHEZZA DEL FERRO QUADRO 7 ESTERNO
PLEASE SPECIFY LENGHT OF EXTERNAL SQUARE SPINDLE 7

art. F1

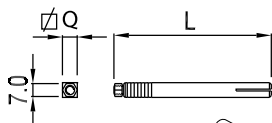

FERRO AD ESPANSIONE CON DADO / EXPANSION SQUARE SPINDLE WITH NUT

		∅	L	€
B007F1065**3E	FERRO 7X65	7	65	•
B008F1055**3E	FERRO 8X55	8	55	•
B008F1065**3E	FERRO 8X65	8	65	•
B008F1080**3E	FERRO 8X80	8	80	•
B008F1095**3E	FERRO 8X95	8	95	•
NEW	B008F1105**3E FERRO 8X105	8	105	•
NEW	B008F1115**3E FERRO 8X115	8	115	•
NEW	B008F1125**3E FERRO 8X125	8	125	*

* Solo a richiesta e per quantità da definire



Extra per confezione self-service in blister da 2 pz.
Extra for self-service blister packing 2 pcs.

€ 1,21

Esempio: € 1,21 + PREZZO ARTICOLO X 2
Example: € 1,21 + ITEM PRICE X 2

art. F1/G



FERRO AD ESPANSIONE CON GANCIO / EXPANSION SQUARE SPINDLE WITH HOOK

			€
B008F1062CG3D	FERRO ∅ 8X62		•
B008F1092CG3D	FERRO ∅ 8X92		•

art. F5



Q1 L1 Q2 L2 €

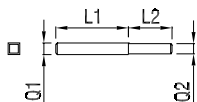

FERRO DOPPIO QUADRO / DOUBLE SQUARE SPINDLE

B545F5850**3D	FERRO Ø 5X45/8X50	•
B630F5750**3D	FERRO Ø 6X30/7X50	•
B630F5850**3D	FERRO Ø 6X30/8X50	•
B730F5840**3D	FERRO Ø 7X30/8X40	•
B730F5845**3D	FERRO Ø 7X30/8X45	•
B730F5890**3D	FERRO Ø 7X30/8X90	•
B740F5845**3D	FERRO Ø 7X40/8X45	•
B745F5845**3D	FERRO Ø 7X45/8X45	•
B775F5810**3D	FERRO Ø 7X75/8X10	•
B790F5845**3D	FERRO Ø 7X90/8X45	•

art. F5



FERRO Ø 8 DOPPIO SNODABILE PER SISTEMA PRIVACY / JOINTED DOUBLE SQUARE SPINDLE FOR PRIVACY SYSTEM

B008F5090**3D

€
•

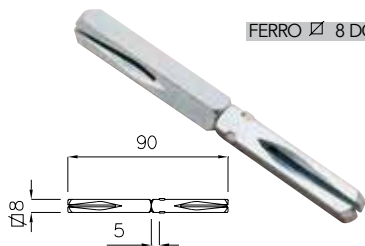

art. CD F6

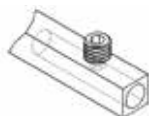

€



B008F60902T3D	Ferro normale zincato ø8X90 mm con 2 fori in testa Square spindle mm ø8X90 with 2 in front holes	•
B008F60982T3D	Ferro normale zincato ø8X98 mm con 2 fori in testa Square spindle mm ø8X98 with 2 in front holes	•
B008F61052T3D	Ferro normale zincato ø8X105 mm con 2 fori in testa Square spindle mm ø8X105 with 2 in front holes	•
B008F61202T3D	Ferro normale zincato ø8X120 mm con 2 fori in testa Square spindle mm ø8X120 with 2 in front holes	•



€

G4	Grano con esagono - punta perforante Grub screw with perforating point	0,27
----	---	------

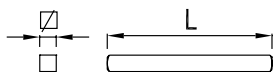

FERRO QUADRO NORMALE -ZINCATO / NORMAL ZINC. SQUARE SPINDLE

		∅	L	€
B005F6065**3D	FERRO ∅ 5X65	5	65	•
B005F6075**3D	FERRO ∅ 5X75	5	75	•
B006F6045**3D	FERRO ∅ 6X45	6	45	•
B006F6075**3D	FERRO ∅ 6X75	6	75	•
B006F6080**3D	FERRO ∅ 6X80	6	80	•
B006F6090**3D	FERRO ∅ 6X90	6	90	•
B006F6100**3D	FERRO ∅ 6X100	6	100	•
B006F6105**3D	FERRO ∅ 6X105	6	105	•
B006F6120**3D	FERRO ∅ 6X120	6	120	•
B007F6075**3D	FERRO ∅ 7X75	7	75	•
B007F6105**3D	FERRO ∅ 7X105	7	105	•
B007F6120**3D	FERRO ∅ 7X120	7	120	•
B007F6130**3D	FERRO ∅ 7X130	7	130	•
B007F6170**3D	FERRO ∅ 7X170	7	170	•
B007F6M10**3A	FERRO ∅ 7X1000 (VERGHE)	7	1.000	•
B008F6065**3D	FERRO ∅ 8X65	8	65	•
B008F6070**3D	FERRO ∅ 8X70	8	70	•
B008F6075**3D	FERRO ∅ 8X75	8	75	•
B008F6080**3D	FERRO ∅ 8X80	8	80	•
B008F6090**3D	FERRO ∅ 8X90	8	90	•
B008F6095**3D	FERRO ∅ 8X95	8	95	•
B008F6100**3D	FERRO ∅ 8X100	8	100	•
B008F6105**3D	FERRO ∅ 8X105	8	105	•
B008F6110**3D	FERRO ∅ 8X110	8	110	•
B008F6120**3D	FERRO ∅ 8X120	8	120	•
B008F6130**3D	FERRO ∅ 8X130	8	130	•
B008F6140**3D	FERRO ∅ 8X140	8	140	•
B008F6150**3D	FERRO ∅ 8X150	8	150	•
B008F6200**3D	FERRO ∅ 8X200	8	200	•
B008F6M10**3A	FERRO ∅ 8X1000 (VERGHE)	8	1.000	•



Extra per confezione self-service in blister da 2 pz.
Extra for self-service blister packing 2 pcs.

€ 1,21

Esempio: € 1,21 + PREZZO ARTICOLO X 2
Example: € 1,21+ ITEM PRICE X 2

art. F8

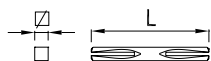

		∅	L	€
FERRO CON 2 FRESATURE E 2 TAGLI / SQUARE SPINDLE WITH 2 MILLED SLOTS				
B007F8095**3D	FERRO ∅ 7X95	7	95	•
B007F8105**3D	FERRO ∅ 7X105	7	105	•
B007F8120**3D	FERRO ∅ 7X120	7	120	•
B008F8090**3D	FERRO ∅ 8X90	8	90	•
B008F8095**3D	FERRO ∅ 8X95	8	95	•
B008F8100**3D	FERRO ∅ 8X100	8	100	•
B008F8105**3D	FERRO ∅ 8X105	8	105	•
B008F8110**3D	FERRO ∅ 8X110	8	110	•
B008F8115**3D	FERRO ∅ 8X115	8	115	•
B008F8120**3D	FERRO ∅ 8X120	8	120	•
B008F8130**3D	FERRO ∅ 8X130	8	130	•
B008F8140**3D	FERRO ∅ 8X140	8	140	•
B008F8150**3D	FERRO ∅ 8X150	8	150	•
B008F8170**3D	FERRO ∅ 8X170	8	170	•



Extra per confezione self-service in blister da 2 pz.
Extra for self-service blister packing 2 pcs.

€ 1,21

Esempio: € 1,21 + PREZZO ARTICOLO X 2
Example: € 1,21 + ITEM PRICE X 2

art. F9

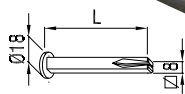

		L	€
FERRO CON PIASTRINA Ø18 FRESATO E TAGLIATO / SQUARE SPINDLE WITH FIXED WASHER AND MILLED SLOT			
B008F9070**3D	FERRO ∅ 8X70	70	•
B008F9090**3D	FERRO ∅ 8X90	90	•

art. F2 FB

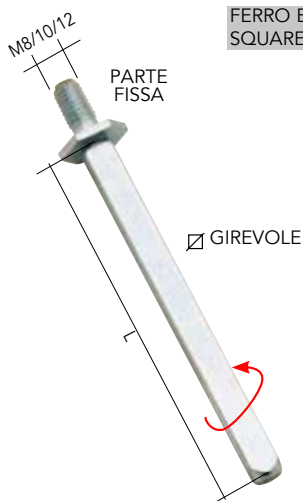

		M	L	€
FERRO BLOCCA POMOLO CON ESAGONO CON FILETTO M8, M10, M12				
SQUARE SPINDLE WITH THREADED ROLLER M8, M10, M12				
BF02FB070083D	FERRO ∅ 8X70 -FILETTO M8	8	70	•
BF02FB080083D	FERRO ∅ 8X80 -FILETTO M8	8	80	•
BF02FB090083D	FERRO ∅ 8X90 -FILETTO M8	8	90	•
BF02FB100083D	FERRO ∅ 8X100 -FILETTO M8	8	100	•
BF02FB110083D	FERRO ∅ 8X110 -FILETTO M8	8	110	•
BF02FB130083D	FERRO ∅ 8X130 -FILETTO M8	8	130	•
BF02FB070103D	FERRO ∅ 8X70 -FILETTO M10	10	70	•
BF02FB080103D	FERRO ∅ 8X80 -FILETTO M10	10	80	•
BF02FB090103D	FERRO ∅ 8X90 -FILETTO M10	10	90	•
BF02FB100103D	FERRO ∅ 8X100 -FILETTO M10	10	100	•
BF02FB110103D	FERRO ∅ 8X110 -FILETTO M10	10	110	•
BF02FB130103D	FERRO ∅ 8X130 -FILETTO M10	10	130	•
BF02FB070123D	FERRO ∅ 8X70 -FILETTO M12	12	70	•

art. F3 FB

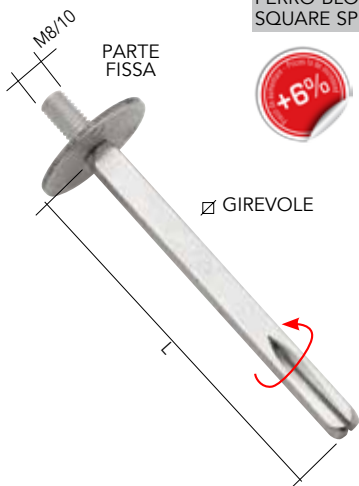

FERRO BLOCCA POMOLO CON PIASTRINA P3 Ø35 FILETTATA M8, M10
SQUARE SPINDLE WITH Ø35 P3 FIXING BASE M8, M10

			M	L	€
BF03FB070083D	FERRO	∅ 8X70 -FILETTO M8	8	70	•
BF03FB080083D	FERRO	∅ 8X80 -FILETTO M8	8	80	•
BF03FB090083D	FERRO	∅ 8X90 -FILETTO M8	8	90	•
BF03FB100083D	FERRO	∅ 8X100 -FILETTO M8	8	100	•
BF03FB110083D	FERRO	∅ 8X110 -FILETTO M8	8	110	•
BF03FB130083D	FERRO	∅ 8X130 -FILETTO M8	8	130	•
BF03FB070103D	FERRO	∅ 8X70 -FILETTO M10	10	70	•
BF03FB080103D	FERRO	∅ 8X80 -FILETTO M10	10	80	•
BF03FB090103D	FERRO	∅ 8X90 -FILETTO M10	10	90	•
BF03FB100103D	FERRO	∅ 8X100 -FILETTO M10	10	100	•
BF03FB110103D	FERRO	∅ 8X110 -FILETTO M10	10	110	•
BF03FB130103D	FERRO	∅ 8X130 -FILETTO M10	10	130	•

art. F4 QB



FERRO BLOCCA POMOLO CON PIASTRINA P2 Ø35 CON QUADRO 8
SQUARE SPINDLE WITH Ø35 P2 FIXING BASE WITH MM 8 SQUARE SPINDLE

					€
BF04QB070083D	FERRO	∅ 8X70			•
BF04QB080083D	FERRO	∅ 8X80			•
BF04QB090083D	FERRO	∅ 8X90			•
BF04QB100083D	FERRO	∅ 8X100			•
BF04QB110083D	FERRO	∅ 8X110			•
BF04QB130083D	FERRO	∅ 8X130			•

art. F10 QB

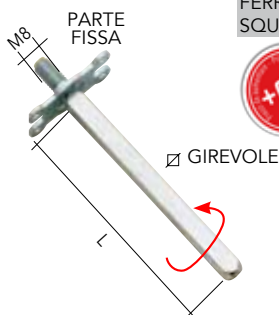

FERRO BLOCCA POMOLO CON PIASTRINA P4 FILETTATA M8
SQUARE SPINDLE WITH M8 THREADED FIXING BASE P4

					€
BF10FB070083D	FERRO	∅ 8X70-FILETTO M8			•
BF10FB080083D	FERRO	∅ 8X80-FILETTO M8			•
BF10FB090083D	FERRO	∅ 8X90-FILETTO M8			•
BF10FB100083D	FERRO	∅ 8X100-FILETTO M8			•
BF10FB110083D	FERRO	∅ 8X110-FILETTO M8			•
BF10FB130083D	FERRO	∅ 8X130-FILETTO M8			•

art. F11 QB

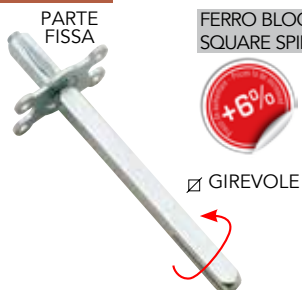

FERRO BLOCCA POMOLO CON PIASTRINA P5 CON QUADRO 8
SQUARE SPINDLE WITH FIXING BASE P5 WITH MM 8 SQUARE SPINDLE

					€
BF11QB070083D	FERRO	∅ 8X70			•
BF11QB080083D	FERRO	∅ 8X80			•
BF11QB090083D	FERRO	∅ 8X90			•
BF11QB100083D	FERRO	∅ 8X100			•
BF11QB110083D	FERRO	∅ 8X110			•
BF11QB130083D	FERRO	∅ 8X130			•

art. P1

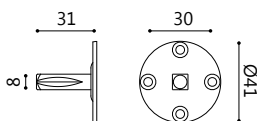

PIASTRINA TONDA Ø41 CON QUADRO 8 / Ø41 FIXING BASE WITH MM 8 SQUARE SPINDLE

B000P1000003D

Piastrina con 4 fori viti ∇ 8x28

€

art. P2

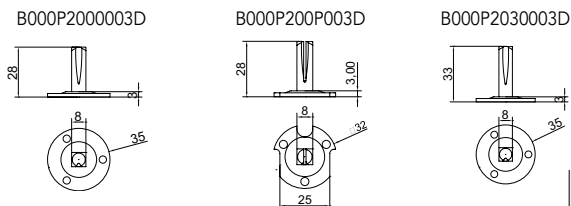

PIASTRINA TONDA Ø35 CON QUADRO 8 / Ø35 FIXING BASE WITH MM 8 SQUARE SPINDLE

B000P2000003D

Piastrina con ∇ 8x25

B000P200P003D

Piastrina sagomata con ∇ 8x24

B000P2030003D

Piastrina con ∇ 8x30

€

art. P3

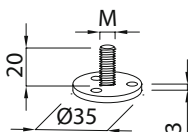

PIASTRINA TONDA Ø35 CON FILETTO M8 O M10 / Ø35 FIXING BASE WITH M8 OR M10 THREADED PIN

B000P3080003D

Piastrina con filetto M8

B000P3100003D

Piastrina con filetto M10

M

€

M8

•

M10

•

art. P4

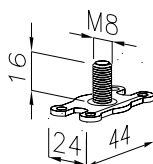

PIASTRINA CON FILETTO M8 / FIXING BASE WITH M8 THREADED PIN

B000P4080003D

Piastrina con filetto M8

€

La dimensione e la forma particolare dell'art. P4 è stata studiata appositamente per consentire l'abbinamento alle rosette ovali tipo 007, C07, 009 e R37 e alle placche per maniglie / Dimension and shape of art. P4 has been studied to fit with oval roses 007, C07, 009, R37 and with plates for lever.

art. P5

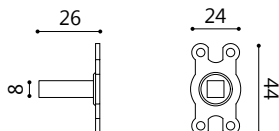

PIASTRINA CON QUADRO 8 / FIXING BASE WITH MM8 SQUARE SPINDLE

B000P5000003D

Piastrina con ∇ 8x26

€

La dimensione e la forma particolare dell'art. P5 è stata studiata appositamente per consentire l'abbinamento alle rosette ovali tipo 007, C07, 009 e R37 e alle placche per maniglie / Dimension and shape of art. P5 has been studied to fit with oval roses 007, C07, 009, R37 and with plates for lever.

art. P6

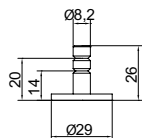

PIASTRINA TONDA Ø29 PER FISSAGGIO MANIGLIONI / Ø29 FIXING BASE FOR FIXED PULL HANDLE

B000P6000003D

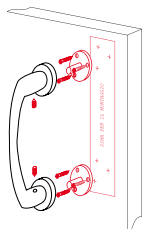

€

art. 1M



1M

MOLLA A CHIOCCIOLA / WINDING SPRING

B8DU1M020**5C

Molla spessore mm 2
2 mm spring

B3DU1M030**5C

Molla spessore mm 3
3 mm spring



€

art. FM

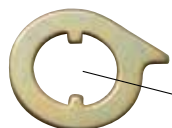

FM

Ø16

B001FM012**3E

Piastrina fermomolla spessore mm 1,2
Spring retainer 1,2 mm



€

art. 3M

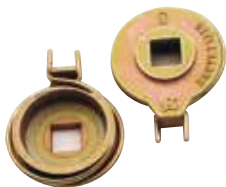

MOLLA AMBIDESTRA DA APPLICARE ALLE PLACCHE.037-049-066-188 / BIDIRECTIONAL RETURNING SPRING FOR PLATES 037-049-066-188

B0003M000**3E



€

art. 4M

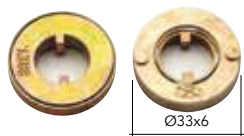

Ø33x6

MOLLA AMBIDESTRA PRECARICATA IN METALLO PER ROS.382 / METAL BIDIRECTIONAL RETURNING SPRING FOR ROSE 382

B0004M000**3E



€

art. 5M



mm 42,5 x 34,5 x 6,1

MOLLA AMBIDESTRA PRECARICATA IN NYLON / NYLON BIDIRECTIONAL RETURNING SPRING

B0085M000**4A



€

art. M9

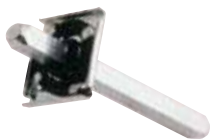

MOLLA CON FERRO / SPRING WITH SQUARE SPINDLE

B006M9105**3D	molla con piastrina mm 33X35 con ferro \square 6 X105	•	€
B008M9105**3D	spring with square spinde mm 6x105	•	
	molla con piastrina mm 33X35 con ferro \square 8X105		
	spring with square spinde mm 8x105		



art. V1 - V9

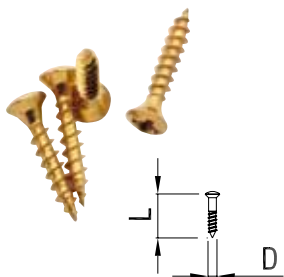

VITI A LEGNO E VITI AUTOFILETTANTI / WOOD SCREWS AND SELF-THREADING SCREWS

		D	L	OTTONATO BRASSED
B+25V1016PS3E	VITE 2,5X16	2,5	16	•
B+25V1020PS3E	VITE 2,5X20	2,5	20	•
B+35V1020GS3F	VITE 3,5X20	3,5	20	•
B+35V1025GS3F	VITE 3,5X25	3,5	25	•
B+35V1030GS3F	VITE 3,5X30	3,5	30	•
B+29V9016PS3D	VITE AUTOFILETTANTE 2,9X16	2,9	16	•
B+48V9038PS3D	VITE AUTOFILETTANTE 4,8x38	4,8	38	•

art. V3

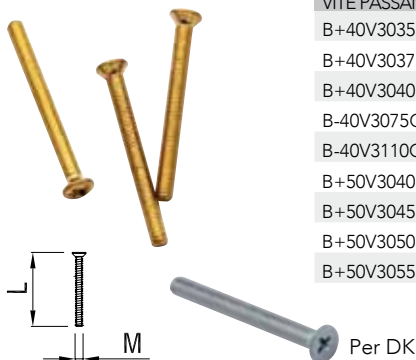

VITE PASSANTE / PASSING SCREW

		M	L	OTTONATO BRASSED	ZINCATO ZINC.
B+40V3035PS3E6	VITE M4X35 CON TESTA \varnothing 6 RIDOTTA	4	35	•	•
B+40V3037PS3F	VITE M4X37	4	37	•	
B+40V3040GS3F	VITE M4X40	4	40	•	
B-40V3075GS3F	VITE M4X75	4	75	•	
B-40V3110GS3F	VITE M4X110	4	110	•	
B+50V3040PS3D	VITE M5X40 - PER DK	5	40		•
B+50V3045PS3D	VITE M5X45 - PER DK	5	45		•
B+50V3050PS3D	VITE M5X50 - PER DK	5	50		•
B+50V3055PS3D	VITE M5X55 - PER DK	5	55		•

art. V4

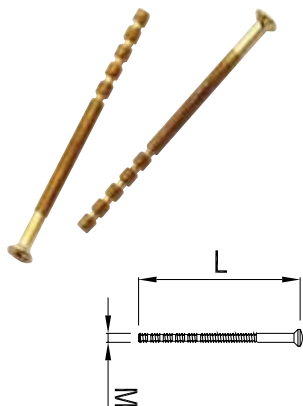

VITE PASSANTE CON CANALINE PASSING SCREW WITH GROOVES FOR CUT

		M	L	H	OTTONATE	BRONZATE	NIKELATE
B+40V4050PS	VITE M4X50 CON TESTA \varnothing 6 RIDOTTA	4	50	7	•	-	-
B+40V4060PS	VITE M4x60	4	60	7	-	•	•
B+40V4070PS	VITE M4x70	4	70	7	-	•	•
B+40V4085PS	VITE M4x85	4	85	7	-	•	•
B+40V4065PS	VITE M4x65 CON TESTA \varnothing 6 RIDOTTA	4	65	5,3	•	-	•
B+40V4070PS	VITE M4x70 CON TESTA \varnothing 6 RIDOTTA	4	70	5,3	•	-	•
B+50V4090GS	VITE M5x90	5	90	7	•	-	•
					PVD		INOX
B+60V4105GS	VITE M6X105	6	105		•		•

art. V5

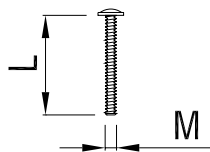

VITE PER POMOLINI PER MOBILI / SCREW FOR FURNITURE ITEMS

		M	L	ZINCATO ZINC. €
BX40V5025BP3E	VITE M4X25	4	25	•

art. V6

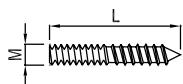

VITE MORDENTE DI GIUNZIONE / DRIVE SCREW THREADED ON ONE SIDE

		M	L	ZINCATO ZINC. €
B040V6025**3D	VITE M4X25	4	25	•
B060V6040**3D	VITE M6X40	6	40	•
B100V6080**3E	VITE M10X80	10	80	•

art. V7



VITE M5				€
B050V7070TC	VITE M5 X 70			•
B050V7090TC	VITE M5 X 90			•
B050V7110TC	VITE M5 X 110			•
B050V7120TC	VITE M5 X 120			•
VITE M6				€
B060V7070TC	VITE M6 X 70			•
B060V7080TC	VITE M6 X 80			•
B060V7100TC	VITE M6 X 100			•
B060V7110TC	VITE M6 X 110			•
VITE M6				€
B060V7090CR3A	Vite M6x90 - testa ribassata			•
B060V7120CR3A	Vite M6x120 - testa ribassata			•

art. T1



T1/325

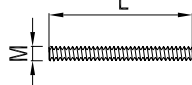

TRONCONE FILETTATO / THREADED BOLT

		M	L	€
B008T1080**3E	TRONCONE M8X80	8	80	•
B008T1095**3E	TRONCONE M8X95	8	95	•
B008T1110**3E	TRONCONE M8X110	8	110	•
B008T1180**3D	TRONCONE M8X180	8	180	•
B010T1090**3E	TRONCONE M10X90	10	90	•
B012T1080**3E	TRONCONE M12X80	12	80	•
B012T1120**3E	TRONCONE M12X120	12	120	•
B010T1325**1C	TRONCONE T1/325 FILETTATO CON CANALINE PER MANETTONI ACCOPPIATI M10 X90	10	90	•

art. B1



BUSSOLA PASSANTE - SENZA TESTA / PASSING BUSH



			L	€
B040B1025001C	bussola M4X25 bush M4X25		25	•
B320B1*****1C	bussola M6 - Ø12x13* bush M6 - Ø12x13*		13	•

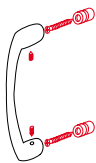

*PER FISSAGGIO MANIGLIONI SENZA ROSETTA
*FOR MOUNTING PULL HANDLE WITHOUT ROSE

art. B1



BUSH WITH CUT



			L	€
B+40B1020TG	bussola M4X20 bush M4X20		20	•
B-40B1030TG	bussola M4X30 bush M4X30		30	•

B1 -B2

BUSSOLE SENZA TAGLIO / BUSH WITHOUT CUT



BZ40B1030TG

BUSSOLA SENZA TAGLIO / BUSH WITHOUT CUT

			M	L	€
BZ40B1030TG	bussola M4X30 zigrinata M4X30 shagreened bush		4	30	•
B040B2020TG	bussola M4X20 sfaccettata M4X20 facet bush		4	20	•
BZ50B1012TP	bussola M5X12 zigrinata M5X12 shagreened bush		5	12	•

B040B2020TG



BZ50B1012TP



art. B3



				€
B010B3014	Bussola fil.int. M10 fil.est.M14 per fissaggio rosette su maniglioni Bush for mounting roses on pull handle			•
B000B3008	Bussola forata Ø 4,20 c/esagono da 17 fil.esterno M8x15			•
B000B3010	Bussola forata Ø 4,20 c/esagono da 17 fil.esterno M10x15			•



art. G1

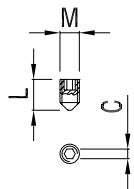

		M	L	C	€
GRANO CON ESAGONO - PUNTA CONICA / GRUB SCREW - CONIC POINT					
B005G1050**3E	GRANO M5X5 GRUB SCREW M5X5	5	5	2,5	•
B005G1080**3E	GRANO M5X8 GRUB SCREW M5X8	5	8	2,5	•
B006G1050**3E	GRANO M6X5 GRUB SCREW M6X5	6	5	3	•
fuori produzione - out of production					
B006G1060**3E	GRANO M6X6 GRUB SCREW M6X6	6	6	3	•
B006G1080**3E	GRANO M6X8 GRUB SCREW M6X8	6	8	3	•
B006G1100**3E	GRANO M6X10 GRUB SCREW M6X10	6	10	3	•
B006G1160**3E	GRANO M6X16 GRUB SCREW M6X16	6	16	3	•

art. G3



		M	L	C	€
GRANO CON ESAGONO - PUNTA A COPPA / GRUB SCREW - CUP POINT					
B006G3050**3E	GRANO M6X5 GRUB SCREW M6X5	6	5	3	•
B006G3080**3E	GRANO M6X8 GRUB SCREW M6X8	6	8	3	•

art. C1

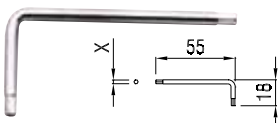

		X	€
CHIAVETTA PER GRANO / KEY FOR GRUB SCREW			
B000C1005**3D	CHIAVETTA DA 2,5 mm PER GRANO M5 2,5 mm KEY FOR GRUB SCREW M5	2,5	•
B000C1006**3D	CHIAVETTA DA 3 mm PER GRANO M6 3 mm KEY FOR GRUB SCREW M6	3	•

		€
CHIAVE CANTIERE PER FORO QUADRO / KEY FOR SQUARE HOLE		
B000C10Q6**3D	CHIAVE PER \varnothing 6 KEY FOR \varnothing 6	•
B000C10Q7**3D	CHIAVE PER \varnothing 7 KEY FOR \varnothing 7	•
B000C10Q8**3D	CHIAVE PER \varnothing 8 KEY FOR \varnothing 8	•
B000C17Q8**3D	CHIAVE PER \varnothing 8/7 KEY FOR \varnothing 8/7	•

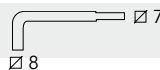

art. R1

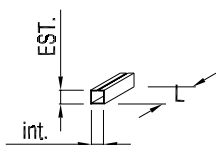

		EST.	INT.	L	€
RIDUZIONE QUADRA IN FERRO / IRON SQUARED SLEEVE					
B006R1007153A	RIDUZIONE DA 7 A 6 X 15	7	6	15	•
B006R1007203A	RIDUZIONE DA 7 A 6 X 20	7	6	20	•
B006R1008153A	RIDUZIONE DA 8 A 6 X 15	8	6	15	•
B006R1008303A	RIDUZIONE DA 8 A 6 X 30	8	6	30	•
B007R1008203A	RIDUZIONE DA 8 A 7 X 20	8	7	20	•
B007R1008303D	RIDUZIONE DA 8 A 7 X 30	8	7	30	•
B008R1009203A	RIDUZIONE DA 9 A 8 X 20	9	8	20	•
B008R1010203A	RIDUZIONE DA 10 A 8 X 20	10	8	20	•
B008R1085303A	RIDUZIONE DA 8,5 A 8 X 30	8,5	8	30	•

art. R2

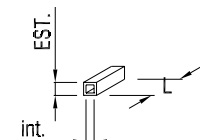

RIDUZIONE QUADRA IN NYLON / NYLON SQUARED SLEEVE

		EST.	INT.	L	€
B004R2008104C	riduzione da 8 a 4	8	4	10	•
B045R2008104C	riduzione da 8 a 4,5	8	4,5	10	•
B005R2008104C	riduzione da 8 a 5	8	5	10	•
B006R2007214C	riduzione da 7 a 6	7	6	21	•
B006R2008104C	riduzione da 8 a 6	8	6	10	•
B006R2008294C	riduzione da 8 a 6 lunghezza 29	8	6	29	•
B007R2008104C	riduzione da 8 a 7	8	7	10	•
B007R2008304C	riduzione da 8 a 7 lunghezza 30	8	7	30	•
B008R2009254C	riduzione da 9 a 8	9	8	25	•

art. AE

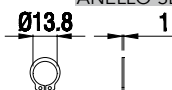

ANELLO SEEGER DA 15 / SEEGER RING 15 DIN 471

		ACCIAIO NERO	ACCIAIO ZINC.
B015AE471**5A		€ 0,08	
B015AE471**3D			•

art. GP

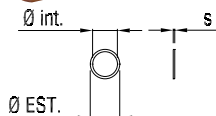

GUARNIZIONI IN NYLON / NYLON WASHERS

		Ø INT	Ø EST	S	€
B016GP019.54D	Guarnizione piana Flat washer	16	19	0,5	•
B016GP019104D	Guarnizione piana Flat washer	16	19	1	•
B016GP021104D	Guarnizione piana Flat washer	16	21	1	•

fuori produzione - out of production

art. GR

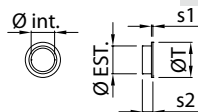

GUARNIZIONI IN NYLON / NYLON WASHERS

		Ø INT	Ø EST	Ø T	S1	S2	€
B016GR018064B	Guarnizione con testa (riduzione foro da 18 a 16) "T" shape washer (reduction from 18 to 16)	16	18	21	1,2	6	•
B016GR020034B	Guarnizione con testa (riduzione foro da 20 a 16) "T" shape washer (reduction from 20 to 16)	16	20	23	1,5	5	•
B016GR195064B	Guarnizione con testa (riduzione foro da 19,5 a 16) "T" shape washer (reduction from 19,5 to 16)	16	19,5	22	1	6,4	•
B018GR195064B	Guarnizione con testa (riduzione foro da 19,5 a 18) "T" shape washer (reduction from 19,5 to 18)	18	19,5	22	1	6,4	•

art. RP

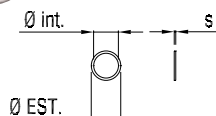

RONDELLA PIANA IN FERRO / IRON FLAT WASHER

		Ø INT	Ø EST	S	€
B162RP020103A		16,2	20	1	•
B162RP020153A		16,2	20	1,5	•
B162RP022025A		16	22	0,2	•
B162RP020043A		16,2	20	0,4	•

art. RN

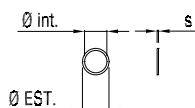

RONDELLA ONDULATA IN ACCIAIO / WAVY STEEL WASHER

B162RN020045B



Ø INT	Ø EST	S	€
16,2	20	0,4	•

art. CD 143



SET 2 VITI PASSANTI M4X12 + 2 BUSSOLE PASSANTI M4X25
+ 2 VITI PASSANTI M4X35
SET 2 SCREWS M4X12 - 2 BUSHES 4X25 - 2 SCREWS M4X35



PER SISTEMA N08 / FOR N08 SYSTEM



Extra per confezione self-service in blister
Extra for self-service blister packing



€

art. CD 144



SET 4 VITI PASSANTI M4X60 CON 4 BUSSOLE M4X20
SET 4 SCREWS M4X60 + 4 BUSHES 4X20



Extra per confezione self-service in blister
Extra for self-service blister packing



€

art. CD 164



SET 2 GRANI 6X5 PUNTA A COPPA + 2 GUARNIZIONI
NYLON + 4 VITI A LEGNO 3,5 X20
SET 4 SCREWS 3,5 X20 + 2 GRUB SCREWS 6X5 CUP POINT
+ 2 PLAST. RINGS



Extra per confezione self-service in blister
Extra for self-service blister packing



€

art. CD 175



SET 4 VITI PASSANTI M4X40 CON 4 BUSSOLE M4X20
SET 4 SCREWS M4X40 + 4 BUSHES 4X20



Extra per confezione self-service in blister
Extra for self-service blister packing



€

art. CD 185



€



SET 4 VITI A LEGNO 3,5 X 25
SET 4 WOOD SCREWS 3,5 X 25



Extra per confezione self-service in blister
Extra for self-service blister packing

art. CD 188



€



SET 8 VITI A LEGNO 3,5 X 25
SET 8 WOOD SCREWS 3,5 X 25



Extra per confezione self-service in blister
Extra for self-service blister packing

art. CD 197



€



SET 2 GRANI 6X6 PUNTA CONICA + 1 CHIAVETTA mm 3
SET 2 GRUB SCREWS 6X6 CONIC POINT + 1 KEY mm 3



Extra per confezione self-service in blister
Extra for self-service blister packing

art. CD 198



€



SET 10 VITI A LEGNO 2,5X16 + 2 GRANI M6X5 PUNTA A COPPA + 1 CHIAVE MM 3
SET 10 WOOD SCREW 2,5X16 + 2 GRUB SCREWS M6X5 CUP POINT + 1 KEY MM 3



Extra per confezione self-service in blister
Extra for self-service blister packing



art. CD 199



€



SET 10 VITI AUTOFILETTANTI 2,9 X16 + 2 GRANI 6X5 PUNTA A COPPA
 SET 10 SELF-THREADING SCREWS 2,9X16 + 2 GRUB SCREW M6X5
 CUP POINT

•



Extra per confezione self-service in blister
 Extra for self-service blister packing

art. CD 201



€



SET 2 GRANI M6X5 PUNTA A COPPA + 1 CHIAVETTA mm 3
 SET 2 GRUB SCREWS M6X5 CUP POINT + 1 KEY mm 3

•



Extra per confezione self-service in blister
 Extra for self-service blister packing

art. CD 202



€



SET 4 VITI A LEGNO 3,5X30
 SET 4 WOOD SCREWS 3,5X30

•



Extra per confezione self-service in blister
 Extra for self-service blister packing

art. CD 210



€



SET 10 VITI A LEGNO 3X16 + 2 GRANI M6X6 PUNTA CONICA + 1 CHIVE MM 3
 SET 10 WOOD SCREWS 3X16 + 2 GRUB SCREW M6X6 CONIC POINT + 1 KEY MM 3

•



Extra per confezione self-service in blister
 Extra for self-service blister packing



art. CD 214



SET 6 VITI PASSANTI M4X50 CON CANALINE -TESTA Ø6
RIDOTTA
SET 6 SCREWS M4X50 WITH GROOVES FOR CUT, Ø6 HEAD

€



Extra per confezione self-service in blister
Extra for self-service blister packing

art. CD 222



SET 1 GRANO 6X6 PUNTA CONICA + 1 GUARNIZIONE NYLON
SET 1 GRUB SCREW 6X6 CONIC POINT + 1 PLASTIC WASHER

€



Extra per confezione self-service in blister
Extra for self-service blister packing

art. CD 236



SET CON 2 VITI 3,5x9 PER COPRINTERRUTTORI SERIE **MAGIC**
SET 2 SCREWS 3,5 X 9 FOR SWITCH COVER **MAGIC**

€



Extra per confezione self-service in blister
Extra for self-service blister packing

art. CD 270

art. CD 269 KIT PER FISSAGGIO MANIGLIONI 325 MS - 326 MS - 327MS



€



SET CON 2 PIASTRINE P6+6 VITI LEGNO 3,5X30+2
GRANI M6X6 PUNTA CONICA + 1 CHIAVETTA mm 3
KIT PER FISSAGGIO MANIGLIONI CON ROS.002
KIT FOR MOUNTING PULL HANDLE WITH 002 ROSE



Extra per confezione self-service in blister
Extra for self-service blister packing

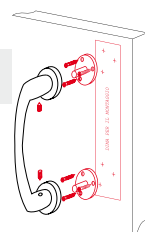

art. CD 320

art. CD 117 Kit (come cd320) adatto per 160 MD e 200 MD



€



SET 2 BUSSOLE FILETTATE M6+2 VITI 4x38
AUTOFIETTANTI DIN 7982+2 GRANI M6X6 PUNTA
CONICA +2 TRONCONI M6+1 CHIAVETTA mm 3
KIT PER FISSAGGIO MANIGLIONI SENZA ROSETTE
KIT FOR MOUNTING PULL HANDLE WITHOUT ROSE



Extra per confezione self-service in blister
Extra for self-service blister packing



art. CD 325



SET CON 2 TRONCONI T1/325 M10 + 12 GUARNIZIONE NYLON PER MANETTONI ACCOPPIATI PER VETRO
 SET 2 SCREW THREADED M10 - 12 NYLON WASHER FOR PAIR PULL HANDLE FOR GLASS DOORS

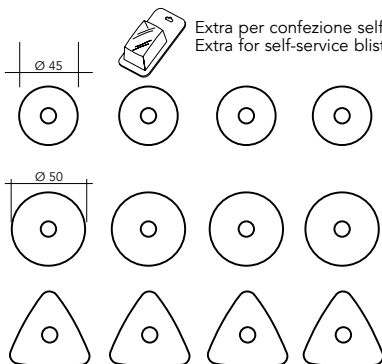
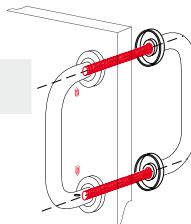

Extra per confezione self-service in blister
 Extra for self-service blister packing

Guarnizioni nylon
 Nylon washer



art. CD F6

SISTEMA CON GRANO PERFORANTE / PERFORATING GRUB SCREW SYSTEM*

- CDF6A Set con 1 ferro $\varnothing 8 \times 90$ mm con **2 fori in testa** + due grani con punta perforante
 Set 1 square spindle mm $\varnothing 8 \times 90$ with **2 in front holes** + 2 grub screws with perforating point
- CDF6B Set con 1 ferro $\varnothing 8 \times 98$ mm con **2 fori in testa** + due grani con punta perforante
 Set 1 square spindle mm $\varnothing 8 \times 98$ with **2 in front holes** + 2 grub screws with perforating point
- CDF6C Set con 1 ferro $\varnothing 8 \times 105$ mm con **2 fori in testa** + due grani con punta perforante
 Set 1 square spindle mm $\varnothing 8 \times 105$ with **2 in front holes** + 2 grub screws with perforating point
- CDF6E Set con 1 ferro $\varnothing 8 \times 120$ mm con **2 fori in testa** + due grani con punta perforante
 Set 1 square spindle mm $\varnothing 8 \times 120$ with **2 in front holes** + 2 grub screws with perforating point



grani da avvitare nel ferro $\varnothing 8$
 grub screw to be screwed into the $\varnothing 8$ mm spindle

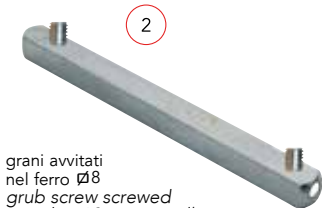
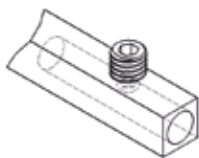

grani avvitati nel ferro $\varnothing 8$
 grub screw screwed into the $\varnothing 8$ mm spindle



fori creati dai grani avvitati nel ferro $\varnothing 8$
 holes made by screwed grub screw point for a superbe fixing

*a richiesta sistema di fissaggio disponibile su tutte le nostre maniglie / on request fixing system available on all our door handles



- B008F60902T3D Ferro normale zincato $\varnothing 8 \times 90$ mm con **2 fori in testa**
 Square spindle mm $\varnothing 8 \times 90$ with **2 in front holes**
- B008F60982T3D Ferro normale zincato $\varnothing 8 \times 98$ mm con **2 fori in testa**
 Square spindle mm $\varnothing 8 \times 98$ with **2 in front holes**
- B008F61052T3D Ferro normale zincato $\varnothing 8 \times 105$ mm con **2 fori in testa**
 Square spindle mm $\varnothing 8 \times 105$ with **2 in front holes**
- B008F61202T3D Ferro normale zincato $\varnothing 8 \times 120$ mm con **2 fori in testa**
 Square spindle mm $\varnothing 8 \times 120$ with **2 in front holes**



G4

Grano con esagono - punta perforante
 Grub screw with perforating point





€



CDPB3M8 SET BASE PER ROS. R50+BUSSOLA B3 C/ESAGONO DA 17-FIL. M8 PER POMOLI FISSI

•



Esempio di applicazione
Mounting example



€

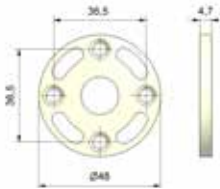

BBASROR50 Base Nylon con 4 fori viti per rosetta R50

•



€



B000B3008 Bussola con esagono da 17 fil.esterno M8 per rosetta R50

•

ARTICOLI DA RICAMBIO

ENDING PRODUCTION ITEMS



art. 32 ONDA

materiale: Ottone
material: Solid Brass



32 MP 032 BG



32 MA 032 BG
32 CR 032 BG

destra/right



32 DK 015 BG

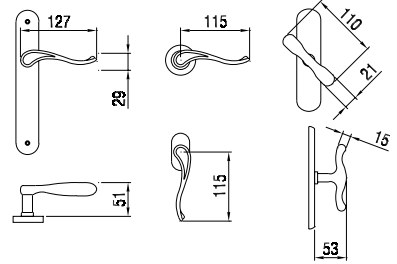

art. 12 CORNO

materiale: Ottone
material: Solid Brass



12 MA 12A LV
12 CR12A LV

12 MR R40 LV

12 MP 012 LV



12 MA 12B OC
12 CR12B OC

12 MP 012 OC

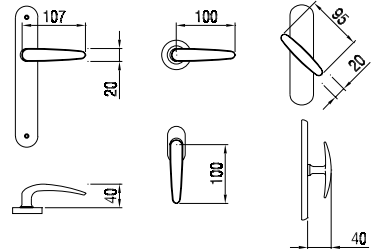

12 CM-OL

art. 27 BAROCCO/PAOLA

materiale: Ottone
material: Solid Brass



27 MA 27B OB
27 CR 27B OB

27 MR 027 OB

27 MP 027 OB

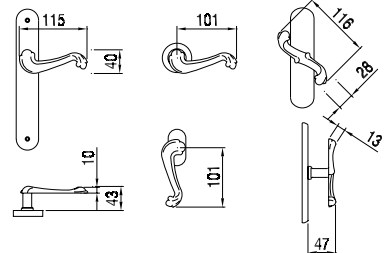



			BG		
MANIGLIA CON PLACCA / LEVER HANDLE ON PLATE					
32 MP 032	Maniglia con placca Lever Handle on plate	032 mm 255x41	con molla with spring	4	
MANIGLIA CON ROSETTA / LEVER HANDLE ON ROSE					
32 MR 003	Maniglia con rosetta Lever Handle on rose	003 mm Ø45x7	con grano with grub screw	5	
CREMONESE / WINDOW HANDLE WITH MECHANISM					
32 CR 032	Cremonese con placca Window Handle on plate	032 mm 174x39	con fori viti con gioco with holes for screws with mechanism	6	
MARTELLINA / WINDOW HANDLE WITHOUT MECHANISM					
32 MA 032	Martellina con placca Window Handle on plate	032 mm 174x39	con fori viti q.7 with holes for screws with square-pin mm 7	6	
DREH KIPP / DREH KIPP					
32 DK 015	Dreh Kipp destro con rosetta Dreh Kipp (right) on rose	015 mm 65x31	con movimento in metallo with metal mechanism	19,77	6



			OL	LV	OC	
MANIGLIA CON PLACCA / LEVER HANDLE ON PLATE						
12 MP 012	Maniglia con placca Lever Handle on plate	012 mm 205x33	•	•	•	6
MANIGLIA CON ROSETTA / LEVER HANDLE ON ROSE						
12 MR R40	Maniglia con rosetta Lever Handle on rose	R40 mm Ø45x7	•	•	•	6
CREMONESE / WINDOW HANDLE WITH MECHANISM						
12 CR 12A	Cremonese con placca Window Handle on plate	12A mm 158x37	con gioco/placca alta (9 mm) with mechanism	•	•	10
12 CR 12B	Cremonese con placca Window Handle on plate	12B mm 152x35	con gioco/placca bassa (6 mm) with mechanism	•	•	10
12 CR 063	Cremonese con placca Window Handle on plate	063 mm 143x37	per aste esterne con gioco G.MP for outside rods with mechanism	•	•	10
MARTELLINA / WINDOW HANDLE WITHOUT MECHANISM						
12 MA 12A	Martellina con placca Window Handle on plate	12A mm 158x37	q.7 placca alta (9 mm) without mechanism with square pin mm 7	•	•	10
12 MA 12B	Martellina con placca Window Handle on plate	12B mm 152x35	q.7 placca bassa (6 mm) without mechanism with square pin mm 7	•	•	10
MANIGLIA PER SERRAMENTI IN FERRO / LEVER HANDLES FOR IRON FRAMES						
12 CM	Maniglia senza imposta q. 6 o 8 con grano Lever handle without guide square spindle 6 or 8 with grub screw		•		•	6



			OB BAROCCO	BF PAOLA	
MANIGLIA CON PLACCA / LEVER HANDLE ON PLATE					
27 MP 027	Maniglia con placca Lever Handle on plate	027 mm 223x35	•	•	6
MANIGLIA CON ROSETTA / LEVER HANDLE ON ROSE					
27 MR 027	Maniglia con rosetta Lever Handle on rose	027 mm 71x34	•	•	6
CREMONESE / WINDOW HANDLE WITH MECHANISM					
27 CR 27A	Cremonese con placca Window Handle on plate	27A mm 183x36	con gioco/placca alta (9 mm) with mechanism	•	10
27 CR 27B	Cremonese con placca Window Handle on plate	27B mm 187x35	con gioco/placca bassa (6 mm) with mechanism	•	10
MARTELLINA / WINDOW HANDLE WITHOUT MECHANISM					
27 MA 27A	Martellina con placca Window Handle on plate	27A mm 183x36	q.7 placca alta (9 mm) without mechanism with square-pin mm 7	•	10
27 MA 27B	Martellina con placca Window Handle on plate	27B mm 187x35	q.7 placca bassa (6 mm) without mechanism with square-pin mm 7	•	10

art. **38 ANNA**

materiale: Ottone
material: Solid Brass

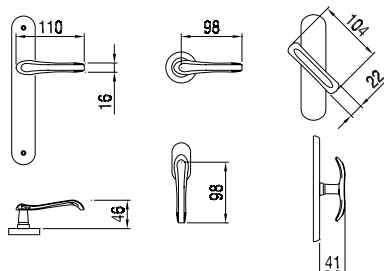

art. **77 ERIDIO**

materiale: Ottone
material: Solid Brass

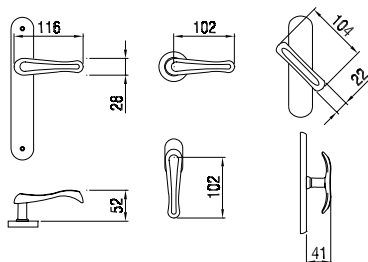



			BS	
MANIGLIA CON PLACCA / LEVER HANDLE ON PLATE				
38 MP 077	Maniglia con placca Lever Handle on plate	077 mm 240X40	•	5
38 MP 077	Maniglia con placca Lever Handle on plate	077 mm 240X40 con molla with spring	•	3
MANIGLIA CON ROSETTA / LEVER HANDLE ON ROSE				
38 MR 034	Maniglia con rosetta Lever Handle on rose	034 mm 85x33 con fori viti with holes for screws	•	5
CREMONESE / WINDOW HANDLE WITH MECHANISM				
38 CR 077	Cremonese con placca Window Handle on plate	077 mm 182x36 con gioco with mechanism	•	10
MARTELLINA / WINDOW HANDLE WITHOUT MECHANISM				
38 MA 077	Martellina con placca Window Handle on plate	077 mm 182x36 q.7 without mechanism with square-pin mm 7	•	10
DREH KIPP / DREH KIPP				
38 DK 015	Dreh Kipp con rosetta Dreh Kipp on rose	015 mm 65x31 con movimento in metallo with metal mechanism	•	6



			BS	
MANIGLIA CON PLACCA / LEVER HANDLE ON PLATE				
77 MP 077	Maniglia con placca Lever Handle on plate	077 mm 240X40	•	5
77 MP 077	Maniglia con placca Lever Handle on plate	077 mm 240X40 con molla with spring	•	3
MANIGLIA CON ROSETTA / LEVER HANDLE ON ROSE				
77 MR 034	Maniglia con rosetta Lever Handle on rose	034 mm 85x33 con fori viti with holes for screws	•	5
CREMONESE / WINDOW HANDLE WITH MECHANISM				
77 CR 077	Cremonese con placca Window Handle on plate	077 mm 182x36 con gioco with mechanism	•	10
MARTELLINA / WINDOW HANDLE WITHOUT MECHANISM				
77 MA 077	Martellina con placca Window Handle on plate	077 mm 182x36 q. 7 without mechanism with square-pin mm 7	•	10
DREH KIPP / DREH KIPP				
77 DK 015	Dreh Kipp con rosetta Dreh Kipp on rose	015 mm 65x31 con movimento in metallo with metal mechanism	•	6

A RICHIESTA / ON REQUEST:

- MEZZA MANIGLIA CON PLACCA O CON ROSETTA (SPECIFICARE SE DESTRA O SINISTRA) / HALF LEVER HANDLE ON PLATE OR ON ROSE (TO SPECIFY IF RIGHT OR LEFT)
- MANIGLIA CON ROSETTA SENZA BOCCHETTA / LEVER HANDLE ON ROSE WITHOUT ROSE FOR KEY
- COPPIE IMPUGNATURE (CM) CON GRANO E FERRO SENZA ROSETTE E SENZA BOCCHETTE / PAIR HANDLES (CM) WITH GRUB SCREWS AND SQUARE PIN WITHOUT ROSE AND WITHOUT ROSE FOR KEY
- CREMONESI E MARTELLINE CON IMPUGNATURA A MANIGLIA (SEGRETINI)

art. 027 RO

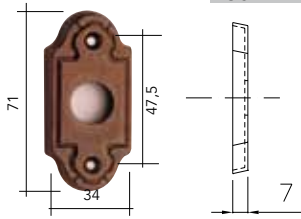

ROSETTA mm 34x71

027 RO Rosetta tipo Barocco
"Barocco" rose

art.027 BN / BY



BOCCHETTA mm 34x71



027 BN Bocchetta
Rose for key

027 BY Bocchetta con foro yale
Rose for euro profile cylinder (yale)



Detrazione per articoli senza bocchetta 027 BN
Deduction for items without rose for key 027 BN



	OB	BS
027 BN	•	•
027 BY	•	•
Detrazione per articoli senza bocchetta 027 BN Deduction for items without rose for key 027 BN	•	•

art.034 RO

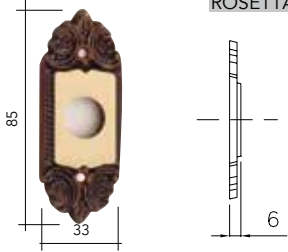

ROSETTA mm 33x85

034 RO Rosetta per maniglia
Rose for key

art.034 BN / BY



BOCCHETTA mm 33x85



034 BN Bocchetta
Rose for key

034 BY Bocchetta con foro yale
Rose for euro profile cylinder (yale)



Detrazione per articoli senza bocchetta 034 BN
Deduction for items without rose for key 034 BN



	BS
034 BN	•
034 BY	•
Detrazione per articoli senza bocchetta 034 BN Deduction for items without rose for key 034 BN	•

art.R35 RO

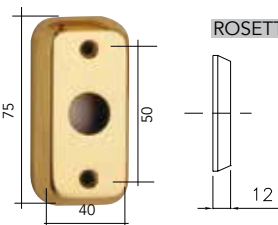

ROSETTA mm 40x75

R35 RO Rosetta adatta ad applicazioni molla
Rose suitable to insert returning spring



art. 035 BN / BY

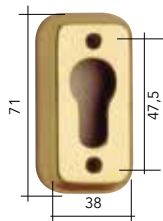

BOCCHETTA mm 38x71



035 BN Bocchetta
Rose for key



035 BY Bocchetta con foro yale
Rose for euro profile cylinder (yale)



Detrazione per articoli senza bocchetta 035 BN
Deduction for items without rose for key 035 BN



LV	LS
BS	

art. R36 RO

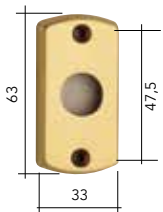

ROSETTA mm 33X63

R36 RO Rosetta per maniglia
Rose for lever handle

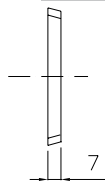

art. 036 BN / BY



BOCCHETTA mm 33X63



036 BN Bocchetta
Rose for key



036 BY Bocchetta con foro yale
Rose for euro profile cylinder (yale)



Detrazione per articoli senza bocchetta 036 BN
Deduction for items without rose for key 036 BN



LV	LS	BS	BG

12 KP

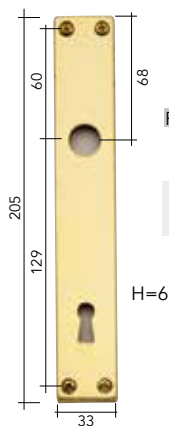

PLACCA PER MANIGLIA / PLATE FOR LEVER HANDLE			
70	85	/	/
90			

12B KM/KC

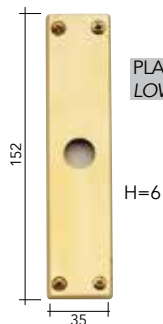

PLACCA BASSA PER CREMONESE O MARTELLINA
LOW PLATE FOR WINDOW HANDLE

27 KP

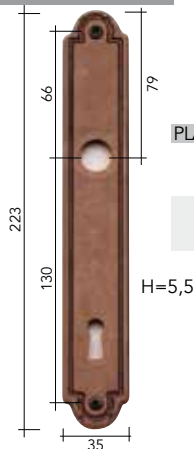

PLACCA PER MANIGLIA / PLATE FOR LEVER HANDLE			
70	85	/	/
90			

27A KM/KC

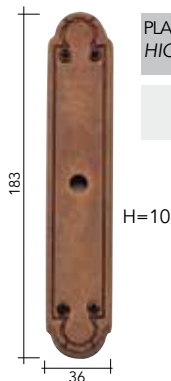

PLACCA ALTA PER CREMONESE O MARTELLINA
HIGH PLATE FOR WINDOW HANDLE

27B KM/KC

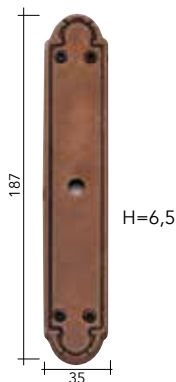

PLACCA BASSA PER CREMONESE O MARTELLINA / LOW PLATE FOR WINDOW HANDLE

35 KP

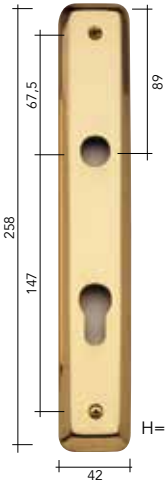

H=10,5

PLACCA PER MANIGLIA / PLATE FOR LEVER HANDLE

	70	70	70	●
	72	72	72	
	75	85	78	
	90	88	85	
		90	90	
		92		

Placca adatta ad applicazione molla di ritorno
Plate suitable to insert returning spring



77 KP

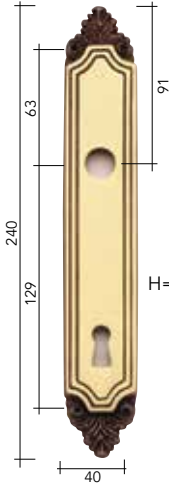

H=7

PLACCA PER MANIGLIA / PLATE FOR LEVER HANDLE

	70	70	70	●
	72	72	72	
	75	85	78	
	90	90	85	
			90	

Placca adatta ad applicazione molla di ritorno
Plate suitable to insert returning spring



77 KM/KC

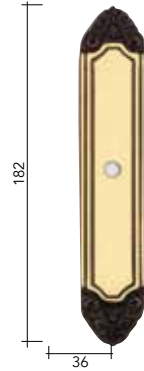

H=9,5

PLACCA ALTA PER CREMONESE O MARTELLINA HIGH PLATE FOR WINDOW HANDLE

181 KP

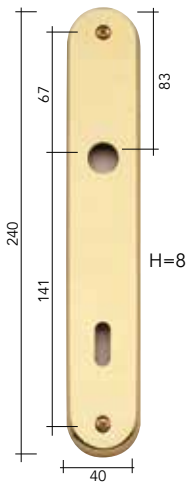

H=8

PLACCA PER MANIGLIA / PLATE FOR LEVER HANDLE

	70	70	70	●
	72	72	72	
	90	85	78	
		88	85	
		90	90	

Placca adatta ad applicazione molla di ritorno
Plate suitable to insert returning spring



F81 KP

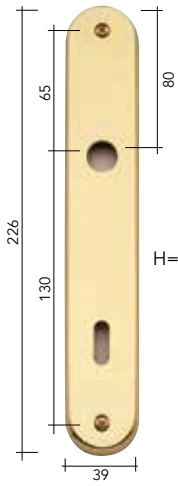

PLACCA PER MANIGLIA / PLATE FOR LEVER HANDLE

				
	70	70	70	●
	90	85	90	
H=8				

* su richiesta /on request

Placca adatta ad applicazione molla di ritorno
Plate suitable to insert returning spring

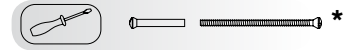

art. 615 PA

OTTONATO
BRASSED



BN



RS

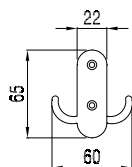

PORTABITO

615 PA

Portabito mm 65x60
Coat-hook mm 65x60



OTTONATO	OC NR	BN RS	
•		•	50

art. 614 GA - 616 GA - 617 GA



614 GA 027 OL



616 GA 035 OL



617 GA 025 OL

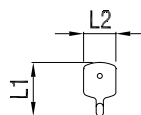

	L1	L2	OL		
GANCIO OTTONE					
614 GA 027	Gancio ottone mm 27 Brass hook mm 27	27	15	•	100
616 GA 030	Gancio ottone mm 30 Brass hook mm 30	30	14	•	100
616 GA 035	Gancio ottone mm 35 Brass hook mm 35	35	16	•	100
617 GA 025	Gancio ottone mm 25 Brass hook mm 25	25	15	•	100

art. 618 GA - 619 GA



618 GA 035 OL



619 GA 035 OL

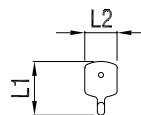

	L1	L2	OL		
GANCIO OTTONE					
618 GA 035	Gancio ottone mm 35 Brass hook mm 35	35	20	•	100
619 GA 035	Gancio mm 36 Hook mm 36	36	23	•	100

art.125 PN



LV

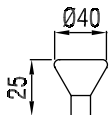

POMOLINO CONCAVO

125 PN 040

Pomolino mm 40
Cambered Small Knob mm 40



LV



•

24

art.128 PN



LV/DEC

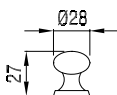

LV/DEC



POMOLINO DECORATO

128 PN 028

Pomolino mm 28
Small Knob mm 28

•

24

art.131 PN



SO

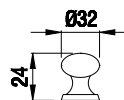

SO



POMOLINO IN PORCELLANA

131 PN 032

Pomolino in porcellana mm 32
Small porcelain Knob mm 32

•

36

art.132 PN



BN



SA

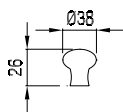

BN

SA



POMOLINO IN PORCELLANA

132 PN 038

Pomolino in porcellana mm 38
Small porcelain Knob mm 38

•

•

36

art.133 PN



BN



SA

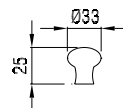

BN

SG

SA



POMOLINO IN PORCELLANA

133 PN 033

Pomolino in porcellana mm 33
Small porcelain Knob mm 33

•

•

36

art.134 PN



BN



SR

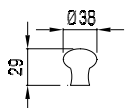

	BN	SA	SR	
POMOLINO IN PORCELLANA				
134 PN 038 Pomolino in porcellana mm 38 Small porcelain Knob mm 38	•		•	36

art.135 PN



BN/OB

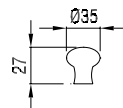

	BN/OB	
POMOLINO IN PORCELLANA		
135 PN 035 Pomolino in porcellana con inserto in ottone mm 35 Small porcelain Knob with item in brass mm 35	•	36

art.138 PN



BF

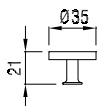

	BF	
POMOLINO		
138 PN 035 Pomolino mm 35 Small Knob mm 35	•	50

art.140 PN



BF

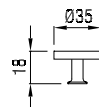

	BF	
POMOLINO		
140 PN 035 Pomolino mm 35 Small Knob mm 35	•	50

art.141 PN



BF

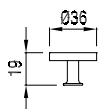

	BF	
POMOLINO		
141 PN 033 Pomolino mm 36 Small Knob mm 36	•	50

art.143 PN



LV/CRIST

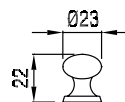

	LV/CRIST.	
POMOLINO CON CRISTALLO		
143 PN 023 Pomolino mm 23 Small Knob with crystal mm 23	•	24

art.145 PN



LV

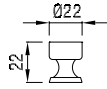

LV



POMOLINO

145 PN 022

Pomolino mm 22
Small Knob mm 22

•

24

art.146 PN



OC/DEC

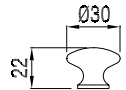

OC/DEC.



POMOLINO

146 PN 030

Pomolino mm 30
Small Knob mm 30

•

24

art.149 PN

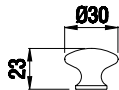

LV/DEC.



POMOLINO

149 PN 030

Pomolino mm 30
Small Knob mm 30

•

24

art.150 PN



LV/SNV

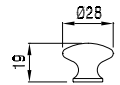

LV/SNV



POMOLINO

150 PN 028

Pomolino mm 28
Small Knob mm 28

•

24

art.151 PN



SNV/LV

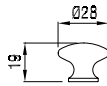

SNV/LV



POMOLINO

151 PN 028

Pomolino mm 28
Small Knob mm 28

•

24

art.152 PN



LV

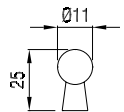

LV



POMOLINO

152 PN 011

Pomolino mm 11
Small Knob mm 11

•

50

art.154 PN



LV

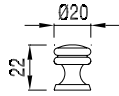

LV



POMOLINO

154 PN 020

Pomolino mm 20
Small Knob mm 20

•

40

art.156 PN



LV

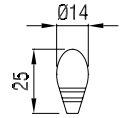

LV



POMOLINO

156 PN 012

Pomolino mm 14
Small Knob mm 14

•

50

art.161 PN



CLG/OC



CLG/OC



POMOLINO

161 PN 020

Pomolino mm 20
Small Knob mm 20

•

40

ESPOSITORI e CONFEZIONI

DISPLAYS & PACKAGING



PACKAGING



Confezione per articoli Vintage Collection
Packaging for Vintage collection items



Confezione per gli articoli CD Sliding Kit
Packing for CD Sliding Kit



Etichetta prodotto
Product Label

Ogni scatola é fornita con un'etichetta che include il codice di rintracciabilità, che vi chiediamo di comunicare in caso di reclamo
Every label is supplied with a label including a traceability code, which we ask you to communicate in case of complaint



Confezioni Standard
Standard Packaging



Confezione/Strip speciale per self-service
Packing/Strip for self-service

ESPOSITORI / DISPLAYS

L'espositore si intende comprensivo di formelle intercambiabili e campionatura
 The display board includes interchangeable panels and samples



a muro / wall panel

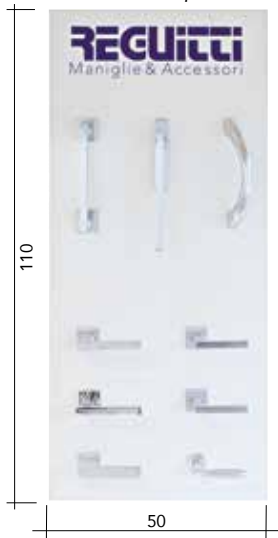

ZES003

da pavimento / panel floor



ZES003/01

girevole / turnable
a 12 posti

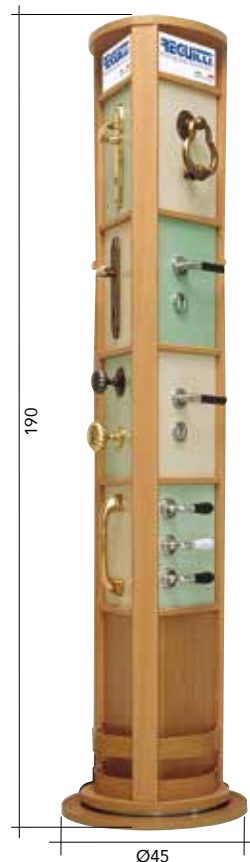

ZES012

a muro / wall panel

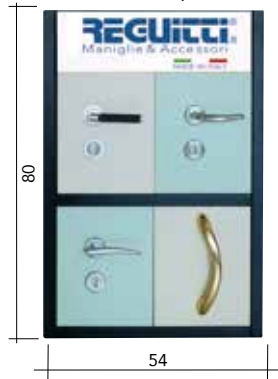

ZES004

singoli / single

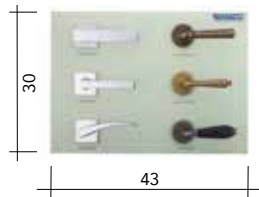

ZES002

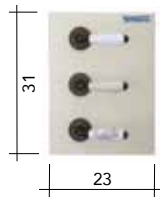

ZES001

BLISTER PER MANIGLIE

BLISTER PACKING FOR LEVER HANDLES



Maniglia con placca
Lever Handle on plate

Extra per confezione self-service in blister
Extra for self-service blister packing



Maniglia con placca con nottolino Wc
Lever Handle on plate with WC turn

Extra per confezione self-service in blister
Extra for self-service blister packing

Maniglia con rosetta e bocchetta
Lever Handle on rose and rose for key

Extra per confezione self-service in blister
Extra for self-service blister packing

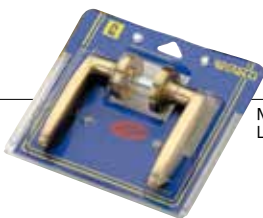

Maniglia con rosetta senza bocchetta
Lever Handle on rose without rose for key



Set da 2 bocchette
Set 2 key roses

Extra per confezione self-service in blister da 2 pz.
Extra for self-service blister packing 2 pcs.



Nottolino WC con rosette
Wc turn on rose

Extra per confezione self-service in blister
Extra for self-service blister packing

Cremonese o martellina
Window handle



Dreh Kipp

Extra per confezione self-service in blister
Extra for self-service blister packing

BLISTER PER BATTENTI BLISTER PACKING FOR DOOR KNOCKERS



Extra per confezione self-service in blister
Extra for packing self-service in blister

BLISTER PER MANIGLIONI BLISTER PACKING FOR PULL HANDLE

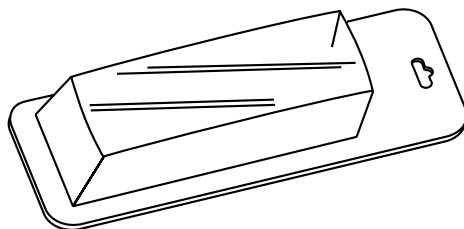

MANIGLIONE SINGOLO
SINGLE PULL HANDLE

BLISTER DI PLACCHE INCASSO PER PORTE SCORREVOLI BLISTER PACKING FOR SLIDING DOORS PLATE



Extra per confezione self-service in blister
Extra for self-service blister packing



Extra per confezione self-service in blister
Extra for self-service blister packing

BLISTER PER COPRIAWVOLGIBILI, RULLINI E COPRINTERRUTTORI BLISTER PACKING FOR BELT SHIFTER, ROLLER BLIND AND SWITCH COVER



Extra per confezione self-service in blister
Extra for self-service blister packing



Extra per confezione self-service in blister
Extra for self-service blister packing

Extra per confezione self-service in blister
Extra for self-service blister packing

BLISTER PER PORTABITI E GANCI BLISTER PACKING FOR HOOK AND COAT-HOOK



Extra per confezione self-service in blister ad 1 pz.
Extra for self-service blister packing 1 pc.

Extra per confezione self-service in blister ad 1 pz.
Extra for self-service blister packing 1 pc.



Extra per confezione self-service in blister a 2 pz.
Extra for self-service blister packing 2 pcs.



Extra per confezione self-service in skin-pack a 4 pz.
Extra for self-service skin-pack packing 4 pcs.

BLISTER PER POMOLINI E MANETTE BLISTER PACKING FOR SMALL KNOBS AND SMALL HANDLE



Esempio di confezione self-service blister ad 1 pz.
Example of self-service blister packing 1 pc.



Extra per confezione self-service blister a 2 pz.
Extra for self-service blister packing 2 pcs.

BLISTER PER ARTICOLI VARI BLISTER PACKING FOR VARIOUS ITEMS



Esempi di confezione self-service blister da 1 pz.
Examples of self-service blister packing 1 pc.



Esempi di confezione self-service blister da 2 pz.
Examples of self-service blister packing 2 pcs.

FINITURE FINISHES



ELENCO IN ORDINE CRESCENTE LIST IN ASCENDING ORDER



02

LV



04

OS



05

OC



07

BF



08

BG



10

BS



15

OSC



18

NR



1M

VBN



2L

FRN/SC



31

SNV



38

OS/LV



39

NC



46

PVD

90

91

92

04

1M

08



47

AGV



61

BN/LV



54

BN/AGV



65

BN/AN



56

NR/LV



67

SO/LV



58

CHAMP/LV



60

LBN/OC



59

CHAMP/AN



75

DEC. C/LV



5F

PVD SAT.



80

DEC.V/AN



5S

INOX SAT.



81

BN/CR



FINITURE FINISHES



ELENCO IN ORDINE CRESCENTE LIST IN ASCENDING ORDER



82

NR/CR



8G

BN/BGO



83

IV/CR



8N

CHAMP/BGO



84

CHAMP/AGV



90

SC/LV



85

NR/AGV



91

CH/LV



88

DEC. C/AGV



92

LBN/LV



8B

PEWTER



96

PSB



8F

BGO



98

PVD INOX



99

ZSV



A6

AL.RS/CR



9A

EB/SC



AA

ARG.F1



9C

EB/OC



AB

BRONZO F4



9D

WE/OSC



BQ

AN



9E

WE/OC



DS

SC/D2



9T

PVD SAT/PVD



F2

OSC/OC



A5

AA/OC



F4

NR/OC

FINITURE FINISHES

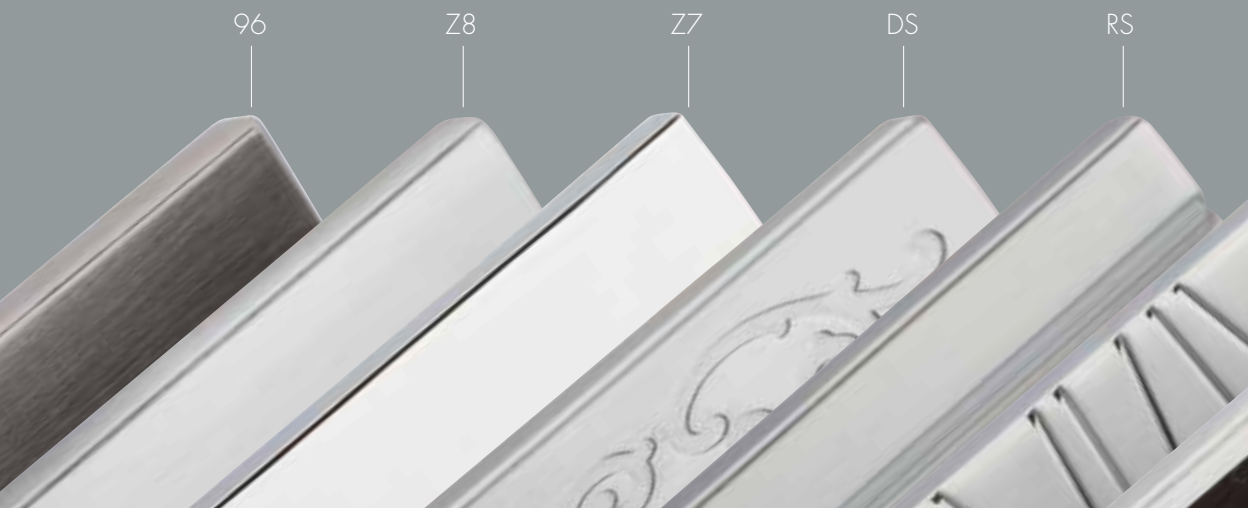

ELENCO IN ORDINE CRESCENTE LIST IN ASCENDING ORDER



F5
NR/OSC



F6
INOX SAT./OC



G2
GM



HT
OC/STRASS



HU
SC/STRASS



K2
OSC/OC/OSC



L6
SC/OC



P4
NR/OC



P5
NR/OSC



P6
BN/OC



P7
BN/OSC



RC
CR/D4



RS
SC/D4



SB
BGO/D3



SS
SC/D3



Z5
ZSC/ZCR



Z6
ZSC/ZCR/OSC



Z7
ZCR



Z8
ZSC

TABELLA FINITURE / FINISHES TABLE

Sigla - Signs	Descrizione - Description	Cod
OTTONE - BRASS		
AGV	Argento Vecchio ANTIGERM® <i>Old Silver Brass ANTIGERM®</i>	47
AN	Ottone Antico ANTIGERM® <i>Antique Brass ANTIGERM®</i>	BQ
ARG/OC	Argento Opaco / Cromato <i>Silver / Bright Chrome Plated</i>	45
AV	Verniciato Avorio - <i>Ivory Varnished</i>	V3
BF	Ottone Bronzato Fumè - <i>Bronzed Fumè Brass</i>	07
BG	Ottone Bronzato Graffiato <i>Scratched Bronzed Brass</i>	08
BGO	Ottone Bronzato Graffiato Opaco ANTIGERM® <i>Matt Scratched Bronzed Brass ANTIGERM®</i>	8F
BGO/D3	DEC. 3 SEGMENTI su Bronzato Graffiato Opaco <i>DEC. 3 SEGMENTI on Matt Scratched Bronzed</i>	SB
BL	Bronzato / Ottone Lucido Verniciato <i>Bronzed / Polished Brass</i>	27
BN	Laccato Bianco azzurrato - <i>White Painted</i>	16
BR.UN	Ottone Bronzato Uniforme - <i>Dark Brass</i>	9F
BS	Ottone Bronzato Satinato - <i>Bronzed Satin Brass</i>	10
BT	Bronzo Toscana - <i>Bronze Tuscany</i>	28
GREZZO	Ottone Grezzo - <i>Raw Brass</i>	1C
LEV	Ottone Lucido Economico Verniciato <i>Cheaper Polished Varnished Brass</i>	E2
LR	Ottone Lucido Naturale (Lucidato non Verniciato) <i>Brass Not Varnished (Natural Brass)</i>	32
LS	Ottone Lucido Satinato - <i>Polished Satin Brass</i>	03
LV	Ottone Lucido Verniciato <i>Polished Varnished Brass</i>	02
NC	Ottone Nero California ANTIGERM® <i>Black California Brass ANTIGERM®</i>	39
NLV	Nichelato Lucido Verniciato - <i>Nikel Plated Varnished</i>	K4
NR	Laccato Nero - <i>Black Painted RAL 9005</i>	18
NR/D2	Decoro 2 su Nero - <i>Dec.2 on Black</i>	DN
NR/LV	Laccato Nero / Ottone Lucido Verniciato <i>Black Painted / Polished Varnished Brass</i>	19
NR/OC	Laccato Nero / Ottone Cromato <i>Black Painted / Chrome Plated</i>	F4
NR/OSC	Laccato Nero / Ottone Satinato Cromato <i>Black Painted / Satin Chrome Plated</i>	F5
OB	Ottone Bronzato - <i>Bronzed Brass</i>	06
OBT	Ottone Bronzo Toscana - <i>Toscana Bronze</i>	28
OC	Ottone Cromato - <i>Bright Chrome Plated Brass</i>	05

Sigla - Signs	Descrizione - Description	Cod
OC/LV	Ottone Cromato / Ottone Lucido Verniciato <i>Bright Chrome Plated / Polished Varnished Brass</i>	26
OC/OSC	Ottone Cromato / Ottone Satinato Cromato <i>Bright Chrome Plated / Satin Chrome Plated Brass</i>	33
OC/SNV	Ottone Cromato / Ottone Satinato Nichelato <i>Bright Chrome Plated / Satin Nikel Plated Varnished Brass</i>	F3
OL	Ottone Lucido <i>Cheaper Polished Brass not Varnished</i>	01
ORO	Ottone placcato oro 24 k - <i>Gold Plated 24 k Brass</i>	21
OS	Ottone Satinato - <i>Satin Varnished Brass</i>	04
OS/LV	Ottone Satinato Verniciato / Ottone Lucido Verniciato <i>Satin Varnished Brass / Polished Varnished Brass</i>	38
OSC	Ottone Satinato Cromato <i>Satin Chrome Plated Brass</i>	15
OSC/OC	Ottone Satinato Cromato / Ottone Cromato <i>Satin Chrome Plated / Bright Chrome Plated</i>	F2
OSC/OC/OSC	Ottone Satinato Cromato / Ottone Cromato / base Ottone Satinato Cromato <i>Satin Chrome Plated / Bright Chrome Plated Brass / base Satin Chrome</i>	K2
PEWTER	Antico Nichelato - Pewter US15A <i>Antique Nickel - Pewter (US15A)</i>	8B
PVD	PVD Lucido Oro - <i>PVD Gold</i>	46
PVD INOX	PVD Inox Satinato - <i>PVD Satin Inox</i>	98
PMS	PVD Matt Silver - <i>PVD Matt Silver</i>	95
PSB	PVD Satin Black - <i>PVD Satin Black</i>	96
PVD SAT.	PVD Satinato Oro - <i>PVD Satin Gold</i>	5F
PVD SAT/PVD	PVD Satinato / PVD Oro <i>PVD Satin / PVD Gold</i>	9T
RAM	Ott. Ramato Vintage - <i>Vintage Coppered</i>	R5
RX	Ottone Ruggine ANTIGERM® <i>Oxid Brass ANTIGERM®</i>	8K
SA	Verniciato Sabbia - <i>Sand Varnished</i>	V4
SC/D2	Decoro 2 su Satinato Cromato <i>Dec.2 on Satin Chrome</i>	DS
SNV	Satinato Nichelato Verniciato <i>Satin Nickel Plated Varnished</i>	31
SNV/OC	Satinato Nichelato Verniciato / Ottone Cromato <i>Satin Nikel Plated Varnished / Bright Chrome Plated Brass</i>	F1
SNV/OC/SNV	Sat. Nikel Verniciato / Ottone Cromato / Sat. Nikel Verniciato <i>Sat. Nik. Plated Varn. / Bright Chrome Plated Brass / Sat. Nik. Plated Varn.</i>	N4
VBN	Ottone Rustico - <i>Rustic Brass</i>	1M
VNR	Verniciato Nero - <i>Black Varnished</i>	V5

ACCIAIO INOX - STAINLESS STEEL

INOX SAT	Acciaio Inox Satinato - <i>Satin Stainless Steel</i>	5S
INOX SAT-AG+	Acciaio Inox Satinato ANTIGERM® <i>Satin Stainless Steel ANTIGERM®</i>	GX
INOX SAT/ARG	Inox Satinato / Argento Opaco <i>Satin Stainless Steel / Mat Silver Brass</i>	14
INOX SAT/OC	Inox Satinato / Ottone Cromato <i>Satin Stainless Steel / Bright Chrome Plated Brass</i>	F6

ZAMA E FERRO - ZAMAK AND IRON

AV	Verniciato Avorio - <i>Ivory Varnished</i>	V3
BN	Laccato Bianco Azzurrato - <i>White Painted</i>	16
BGO/D3	DEC.3 SEGMENTI su Bronzato Graffiato Opaco <i>DEC.3 SEGMENTI on Matt Scratched Bronzed</i>	SB
CR/D4	DEC.4 RIGA su Cromato <i>DEC.4 RIGA on Chrome Plated</i>	RC
NLV	Nichelato Lucido Verniciato - <i>Nikel Plated Varnished</i>	K4
NR	Laccato Nero - <i>Painted Black RAL 9005</i>	18
NR/D2	Decoro 2 su Nero - <i>Dec.2 on Black</i>	DN
OTTONATO	Ottonato - <i>Brassed</i>	41
OC/STRASS	STRASS su Cromato Lucido <i>Strass on Chrome Plated</i>	HT
PVD	PVD Lucido Oro - <i>PVD Gold</i>	46
PVD INOX	PVD Inox Satinato - <i>PVD Satin Inox</i>	98
PMS	PVD Matt Silver - <i>PVD Matt Silver</i>	95
PSB	PVD Satin Black - <i>PVD Satin Black</i>	96
RS	Laccato Rosso - <i>Red Painted</i>	30
SA	Verniciato Sabbia - <i>Sand Varnished</i>	V4
SC/D2	Decoro 2 su Satinato Cromato <i>Dec.2 on Satin Chrome</i>	DS
SC/D3	DEC.3 SEGMENTI su Satinato Cromato <i>DEC.3 SEGMENTI on Satin Chrome Plated</i>	SS
SC/D4	DEC.4 RIGA su Satinato Cromato <i>DEC.4 RIGA on Satin Chrome Plated</i>	RS
SC/STRASS	STRASS su Satinato Cromato <i>Strass on Satin Chrome Plated</i>	HU
SNV	Satinato Nichelato Verniciato <i>Satin Nickel Plated Varnished</i>	31
SNV/NLV	Satinato Nichelato Verniciato / Nichelato Lucido Verniciato <i>Satin Nickel Plated Varnished / Nikel Plated Varnished</i>	N2

SNV/NLV/SNV	Sat. Nik. Vern. / Nichelato Lucido Verniciato / Sat. Nik. Vern. <i>Sat. Nik. Pl. Varn. / Nikel Pl. Varn. / Sat. Nik. Pl. Varn.</i>	N3
SNV/OC	Satinato Nichelato Verniciato / Ottone Cromato <i>Satin Nickel Plated Varnished / Bright Chrome Plated Brass</i>	F1
SNV/OC/SNV	Sat. Nik. Vern. / Ottone Cromato / Sat. Nik. Vern. <i>Sat. Nik. Pl. Varn. / B. Chrome Pl. Brass / Sat. Nik. Pl. Varn.</i>	N4
VNR	Verniciato Nero - <i>Black Varnished</i>	V5
ZBG	Zama Bronzata Graffiata / <i>Scratched Bronzed Zamak</i>	Z4
ZCR	Zama Cromata - <i>Chrome Plated Zamak</i>	Z7
ZLV	Zama Lucida Verniciata / <i>Zamak Polished Brass effect</i>	2V
ZSC	Zama Satinata Cromata <i>Satin Chrome Plated Zamak</i>	Z8
ZSC/ZCR	Zama Satinata Cromata / Zama Cromata <i>Satin Chrome Plated Zamak / Chrome Plated Zamak</i>	Z5
ZSC/ZCR/OSC	Zama Satinata Cromata / Zama Cromata / base Ottone Satinato Cromato <i>Satin Chrome Plated Zamak / Chrome Plated Zamak / Base Satin Chrome</i>	Z6
ZSO	Zama Satinata Ottonata - <i>Satin Brassed Zamak</i>	Z9
ZSV	Zama Satinata Verniciata - <i>Satin Varnished Zamak</i>	99

ALLUMINIO - ALUMINIUM

AA/OC	Alluminio / Ottone Cromato <i>Aluminum / Bright Chrome Plated Brass</i>	A5
ARG.F1	Alluminio Anodizzato Argento F1 <i>Anodized Silver Aluminium</i>	AA
BRONZO F4	Alluminio Anodizzato Bronzo F4 <i>Anodized Bronzed Aluminium</i>	AB
ALL. CROM.	Alluminio Cromato - <i>Chrome plated Aluminium</i>	AC
ALL.CROM. OP.	Alluminio Cromato Opaco <i>Mat. Chrome plated Aluminium</i>	AS
ALL.OTT.	Alluminio Ottonato - <i>Brassed Aluminium</i>	AT
NR	Alluminio Laccato Nero <i>Black Painted Aluminium RAL 9005</i>	NR
ORO F3	Alluminio Anodizzato Oro F3 <i>Gold Chrome plated Aluminium</i>	AO
AL.RS/CR	Alluminio rosso / Cromo Lucido <i>Red Aluminium / Bright Chrome Plated</i>	A6
AL.SAT.	Alluminio Satinato Cromato - <i>Aluminium Satin Chrome</i>	AQ

TABELLA FINITURE / FINISHES TABLE

Sigla - Signs	Descrizione - Description	Cod	Sigla - Signs	Descrizione - Description	Cod
PORCELLANA/OTTONE - PORCELAIN/BRASS					
BN	Porcellana Bianca - White Porcelain	60	DEC. C/BGO	Porcellana Decoro Fiore "C" / Ottone Bronzato Graffiato Opaco <i>"C" Flower Decorated Porcelain / Matt Scratched Bronzed Brass</i>	8M
BN/AGV	Porcellana Bianca / Argento Vecchio <i>White Porcelain / Old Silver Brass</i>	54	DEC. C/LV	Porcellana Decoro Fiore "C" / Ottone Lucido Verniciato <i>"C" Flower Decorated Porcelain / Polished Varnished Brass</i>	75
BN/AN	Porcellana Bianca / Ottone Antico <i>White Porcelain / Antique Brass</i>	65	DEC. C/RX	Porcellana Decoro Fiore "C" / Ottone Ruggine <i>"C" Flower Decorated Porcelain / Oxide Brass</i>	8T
BN/BGO	Porcellana Bianca / Ottone Bronzato Graffiato Opaco <i>White Porcelain / Matt Scratched Bronzed Brass</i>	8G	DEC. H/AGV	Porcellana Decoro Fiore Harmony / Argento Vecchio <i>Harmony Flower Decorated Porcelain / Old Silver Brass</i>	8J
BN/LV	Porcellana Bianca / Ottone Lucido Verniciato <i>White Porcelain / Polished Varnished Brass</i>	61	DEC. H/AN	Porcellana Decoro Fiore Harmony / Ottone Antico <i>Harmony Flower Decorated Porcelain / Antique Brass</i>	49
BN/OB	Porcellana Bianca / Ottone Bronzato <i>White Porcelain / Bronzed Brass</i>	62	DEC. H/BGO	Porcellana Decoro Fiore Harmony / Ottone Bronzato Graffiato Opaco <i>Harmony Flower Decorated Porcelain / Matt Scratched Bronzed Brass</i>	8H
BN/OC	Porcellana Bianca / Ottone Cromato <i>White Porcelain / Bright Chrome Plated</i>	P6	DEC. H/LV	Porcellana Decoro Fiore Harmony / Ottone Lucido Verniciato <i>Harmony Flower Decorated Porcelain / Polished Varnished Brass</i>	48
BN/OL	Porcellana Bianca / Ottone Lucido <i>White Porcelain / Cheaper Polished Brass</i>	P1	DEC. H/RX	Porcellana Decoro Fiore Harmony / Ottone Ruggine <i>Harmony Flower Decorated Porcelain / Oxide Brass</i>	8U
BN/OSC	Porcellana Bianca / Ottone Satinato Cromato <i>White Porcelain / Satin Chrome Plated</i>	P7	DEC. V/AGV	Porcellana Decoro Fiore Verde / Argento Vecchio <i>Green Flower Decorated Porcelain / Old Silver Brass</i>	8W
BN/RX	Porcellana Bianca / Ottone Ruggine <i>White Porcelain / Oxide Brass</i>	8Q	DEC. V/AN	Porcellana Decoro Fiore Verde / Ottone Antico <i>Green Flower Decorated Porcelain / Antique Brass</i>	80
BN/VBN	Porcellana Bianca / Ottone Rustico <i>White Porcelain / Rustic Brass</i>	8D	DEC. V/BGO	Porcellana Decoro Fiore Verde / Ottone Bronzato Graffiato Opaco <i>Green Flower Decorated Porcelain / Matt Scratched Bronzed Brass</i>	8I
CHAMP/AGV	Porcellana Champagne / Argento Vecchio <i>Champagne Porcelain / Old Silver Brass</i>	84	DEC. V/LV	Porcellana Decoro Fiore Verde / Ottone Lucido Verniciato <i>Green Flower Decorated Porcelain / Polished Varnished Brass</i>	70
CHAMP/AN	Porcellana Champagne / Ottone Antico <i>Champagne Porcelain / Antique Brass</i>	59	DEC. V/RX	Porcellana Decoro Fiore Verde / Ottone Ruggine <i>Green Flower Decorated Porcelain / Oxide Brass</i>	8V
CHAMP/BGO	Porcellana Champagne / Ottone Bronzato Graffiato Opaco <i>Champagne Porcelain / Matt Scratched Bronzed Brass</i>	8N	NR/AGV	Porcellana Nero Opaco / Argento Vecchio <i>Black Porcelain / Old Silver Brass</i>	85
CHAMP/LV	Porcellana Champagne / Ottone Lucido Verniciato <i>Champagne Porcelain / Polished Varnished Brass</i>	58	NR/LV	Porcellana Nera/Ottone Lucido Verniciato <i>Black Porcelain / Polished Varnished Brass</i>	56
CHAMP/OC	Porcellana Champagne / Ottone Cromato <i>Champagne Porcelain / Bright Chrome Plated</i>	8P	NR/OC	Porcellana Nero Opaco/Ottone Cromato <i>Black Porcelain / Bright Chrome Plated</i>	P4
CHAMP/OL	Porcellana Champagne / Ottone Lucido <i>Champagne Porcelain / Cheaper Polished Brass</i>	P3	NR/OL	Porcellana Nero Opaco / Ottone Lucido <i>Black Porcelain / Cheaper Polished Brass</i>	P2
CHAMP/RX	Porcellana Champagne / Ottone Ruggine <i>Champagne Porcelain / Oxide Brass</i>	8S	NR/OSC	Porcellana Nero Opaco / Ottone Satinato Cromato <i>Black Porcelain / Satin Chrome Plated</i>	P5
CHAMP/VBN	Porcellana Champagne / Ottone Rustico <i>Champagne Porcelain / Rustic Brass</i>	8E	SO	Porcellana Striscia Oro - Golden Line Porcelain	66
DEC. B/AGV	Porcellana Decoro Blue / Argento Vecchio <i>Blue Flower Decorated Porcelain / Old Silver Brass</i>	8X	SO/LV	Porcellana Striscia Oro / Lucido Verniciato <i>Golden Line Porcelain / Polished Varnished Brass</i>	67
DEC. B/AN	Porcellana Decoro Blue / Ottone Antico <i>Blue Flower Decorated Porcelain / Antique Brass</i>	87			
DEC. B/BGO	Porcellana Decoro Blue / Ottone Bronzato Graffiato Opaco <i>Blue Flower Decorated Porcelain / Matt Scratched Bronzed Brass</i>	8L			
DEC. B/LV	Porcellana Decoro Blue / Ottone Lucido Verniciato <i>Blue Flower Decorated Porcelain / Polished Varnished Brass</i>	86			
DEC. B/RX	Porcellana Decoro Blue / Ottone Ruggine <i>Blue Flower Decorated Porcelain / Oxide Brass</i>	8Y			
DEC. C	Porcellana Decoro Fiore "C" <i>"C" Flower Decorated Porcelain</i>	74			
DEC. C/AGV	Porcellana Decoro Fiore "C" / Argento Vecchio <i>"C" Flower Decorated Porcelain / Old Silver Brass</i>	88			
DEC. C/AN	Porcellana Decoro Fiore "C" / Ottone Antico <i>"C" Flower Decorated Porcelain / Antique Brass</i>	76			

LEGGNO/METALLO - WOOD/METAL		
CH/LV	Legno Pino / Ottone Lucido Verniciato <i>Pine Wood / Polished Varnished Brass</i>	91
CH/OL	Legno Pino / Ottone Lucido <i>Pine Wood / Cheaper Polished Brass not Varnished</i>	L2
CLG/LV	Legno Ciliegio / Ottone Lucido Verniciato <i>Cherry Wood / Polished Varnished Brass</i>	7L
CLG/OC	Legno Ciliegio / Ottone Cromato <i>Cherry Wood / Bright Chrome Plated Brass</i>	L5
CLG/OSC	Legno Ciliegio / Ottone Satinato Cromato <i>Cherry Wood / Satin Chrome Plated Brass</i>	L7
EB/CR	Legno Ebano / Zama Cromato <i>Ebony / Chrome Plated</i>	9C
EB/SC	Legno Ebano / Zama Satinata Cromata <i>Ebony / Satin Chrome Plated</i>	9A
FG/LV	Legno Faggio / ottone Lucido Verniciato <i>Beech Wood / Polished Varnished Brass</i>	5L
FG/OC	Legno Faggio / Cromato <i>Beech Wood / Bright Chrome Plated Brass</i>	9L
FG/OSC	Legno Faggio / Ottone Satinato Cromato <i>Beech Wood / Satin Chrome Plated Brass</i>	L9
FRN/SC	Nero Frassino / Ottone Satinato Cromato <i>Black Ash / Satin Chrome Plated</i>	2L
LBN/LV	Legno Laccato Bianco / Lucido Verniciato <i>Painted White Wood / Polished Varnished Brass</i>	92
LBN/OC	Legno Laccato Bianco / Ottone Cromato <i>White Painted Wood / Bright Chrome Plated Brass</i>	60
LBN/OL	Legno Laccato Bianco / Ottone Lucido <i>White Painted Wood / Cheaper Polished Brass not Varnished</i>	L3
LNR/LV	Legno Laccato Nero / Ottone Lucido Verniciato <i>Black Painted Wood / Polished Varnished Brass</i>	89
LNR/OL	Legno Laccato Nero / Ottone Lucido <i>Painted Black Brass / Cheaper Polished Brass not Varnished</i>	L4
SC/LV	Legno Scuro / Ottone Lucido Verniciato <i>Dark Wood / Polished Varnished Brass</i>	90
SC/OC	Legno Scuro / Ottone Cromato <i>Dark Wood / Bright Chrome Plated Brass</i>	L6
SC/OL	Legno Scuro / Ottone Lucido <i>Dark Wood / Cheaper Polished Brass not Varnished</i>	L1
SC/OSC	Legno Scuro / Ottone Satinato Cromato <i>Dark Wood / Satin Chrome Plated Brass</i>	L8
WE/CR	Legno Wengè / Zama Cromato <i>Wengè / Chrome Plated</i>	9E
WE/SC	Legno Wengè / Zama Satinata Cromata <i>Wengè / Satin Chrome Plated</i>	9D

PLASTICA/METALLO - PLASTIC/METAL		
BN	Plastica Bianca - <i>White Plastic</i>	4F
BN/LV	Plastica Bianca / Ottone Lucido Verniciato <i>White Plastic / Polished Varnished Brass</i>	F8
BN/CR	Plastica Bianca / Cromato <i>White Plastic / Bright Chrome Plated</i>	81
BN/SC	Plastica Bianca / Satinato Cromato <i>White Plastic / Satin Chrome Plated</i>	S8
IV/CR	Plastica Avorio / Cromato <i>Ivory Plastic / Chrome Plated</i>	83
NR	Plastica Nera - <i>Black Plastic</i>	4C
NR/LV	Plastica Nera / Ottone Lucido Verniciato <i>Black Plastic / Polished Varnished Brass</i>	F7
NR/CR	Plastica Nera / Cromato <i>Black Plastic / Bright Chrome Plated</i>	82
NR/OSC	Plastica Nera / Satinato Cromato <i>Black Plastic / Satin Chrome Plated</i>	S7
RS	Plastica Rossa - <i>Red Plastic</i>	4R
RS/LV	Plastica Rossa / Ottone Lucido Verniciato <i>Red Plastic / Polished Varnished Brass</i>	F9
RS/OC	Plastica Rossa / Cromato <i>Red Plastic / Bright Chrome Plated</i>	C9
RS/OSC	Plastica Rossa / Satinato Cromato <i>Red Plastic / Satin Chrome Plated</i>	S9

Indice per codice - Item index

Codici	Pagine	Codici	Pagine	Codici	Pagine	Codici	Pagine
000CD002	59, 66, 87, 100, 109, 111, 758	000CD079	664	000CD628	640	000CD801	627
000CD004	759	000CD080	669	000CD636	622	000CD802	629
000CD005	761	000CD081	669	000CD638	623	000CD803	630
000CD006	59, 66, 87, 100, 111, 758	000CD082	646	000CD63Y	209	000CD804	631
000CD008	759	000CD090	641	000CD640	658	000CD805	632
000CD015	641	000CD091	652	000CD641	659	000CD806	633
000CD016	652	000CD092	647	000CD650	627	000CD807	635
000CD017	660	000CD093	709	000CD651	627	000CD808	636
000CD018	665	000CD096	646	000CD652	629	000CD809	637
000CD020	685	000CD098	634	000CD653	629	000CD810	638
000CD021	685	000CD099	634	000CD654	630	000CD811	639
000CD022	683	000CD143	983	000CD655	630	000CD812	640
000CD023	683	000CD144	983	000CD656	631	000CD813	634
000CD024	691	000CD164	983	000CD657	631	000CD815	657
000CD025	691	000CD175	983	000CD658	632	000CD820	625
000CD026	692	000CD185	984	000CD659	632	000CD821	625
000CD027	692	000CD188	984	000CD660	633	000CD822	647
000CD028	670	000CD197	984	000CD661	633	000CD823	625
000CD031	647	000CD198	984	000CD662	635	000CD824	658
000CD032	662	000CD199	985	000CD663	636	000CD825	659
000CD033	667	000CD19D	677	000CD664	637	000CD828	626
000CD035	687	000CD201	985	000CD665	638	000CD829	626
000CD036	687	000CD202	985	000CD666	639	000CD82S	625
000CD037	672	000CD210	985	000CD667	640	000CD830	626
000CD038	693	000CD214	986	000CD667	640	000CD831	651
000CD039	693	000CD222	986	000CD675	622	000CD832	688
000CD043	649	000CD222	986	000CD676	622	000CD833	688
000CD044	647	000CD236	986	000CD679	623	000CD834	688
000CD045	649	000CD24A	203	000CD680	623	000CD835	688
000CD046	662	000CD265	503, 545, 556	000CD683	658	000CD835	626
000CD048	667	000CD270	986	000CD684	659	000CD850	641
000CD050	641	000CD275	503, 545, 556	000CD685	672	000CD851	652
000CD051	652	000CD276	503, 545, 556	000CD6D1	637	000CD863	683
000CD054	660	000CD277	503, 545, 556	000CD6D4	637	000CD865	691
000CD055	687	000CD311	711	000CD701	619	000CD867	692
000CD056	693	000CD313	711	000CD703	619	000CD876	657
000CD057	670	000CD320	986	000CD705	619	000CD919	676
000CD058	665	000CD325	503, 987	000CD711	620	000CD924	695
000CD059	680	000CD60D	677	000CD713	620	000CD925	695
000CD061	685	000CD615	627	000CD715	620	000CD928	675
000CD062	670	000CD616	629	000CD719	681	000CD92S	675
000CD063	683	000CD617	630	000CD71Q	682	000CD932	678
000CD065	691	000CD618	631	000CD720	681	000CD937	673
000CD067	692	000CD619	632	000CD721	621	000CD938	694
000CD068	672	000CD620	633	000CD723	621	000CD939	694
000CD069	670	000CD621	635	000CD725	621	000CD946	678
000CD070	680	000CD622	636	000CD72Q	682	000CD956	694
000CD076	657	000CD623	635	000CD730	689	000CD957	674
000CD077	646	000CD624	636	000CD73Q	690	000CD960	676
000CD078	664	000CD625	638	000CD75A	202	000CD962	675
		000CD626	638	000CD76S	657	000CD965	695
		000CD627	639	000CD7QY	209		

Indice per codice - Item index

Codici	Pagine	Codici	Pagine	Codici	Pagine	Codici	Pagine
000CD968	673	000CDQ06	371, 759	003RO	496, 874	011BN	923
000CD969	674	000CDQ15	643	004BY	915	011BY	66, 88, 923
000CD96S	673	000CDQ16	654	004RO	874	011RO	876
000CD96Y	695	000CDQ20	686	004SR	965, 966	011SR	708
000CD9D2	679	000CDQ22	684	005BC	916	012BKC	996
000CD9D6	679	000CDQ23	684	005BN	916	012BKM	996
000CD9Y5	695	000CDQ2Y	684	005BW	917	012CM	991
000CDD15	644	000CDQ50	643	005BY	916	012CR	991
000CDD16	655	000CDQ51	654	005DM	917	012KP	996
000CDD17	661	000CDQ63	684	005RO	875	012MA	991
000CDD18	666	000CDQ6Y	684	006BA	59, 66, 87, 100, 108, 112, 123, 126, 131, 132, 135, 136, 546	012MP	991
000CDD1Q	645	000CDQ72	618			012MR	991
000CDD28	671	000CDQ73	618	006BC	918	012SR	709
000CDD31	651	000CDQ77	618	006BN	917	013BA	59, 66, 80, 87, 100, 108, 112, 123, 126, 135, 136, 551
000CDD32	663	000CDQ7A	202	006BW	481, 918	013SR	710
000CDD33	668	000CDQ7Y	618	006BY	59, 66, 79, 88, 100, 109, 112, 123, 127, 132, 136, 140, 481, 918	014BA	552
000CDD3Q	650	000CDQ85	643	006CY	174	014RO	913
000CDD44	651	000CDQ90	643	006DM	919	015RO	877
000CDD46	663	000CDQ91	654	006PT	709	016CR	225
000CDD48	668	000CDQD1	656	006RO	875	016DK	225
000CDD4Q	650	000CDQD6	656	006SR	706	016HM	779
000CDD50	644	000CDQD9	656	007BA	59, 66, 80, 87, 139, 140, 547	016LD	735
000CDD51	655	000CDQY7	618	007BC	920	016MA	225
000CDD54	661	000CDY23	683	007BN	919	016MD	735
000CDD57	671	000CDY25	691	007BY	59, 66, 79, 88, 100, 109, 112, 123, 127, 136, 919	016MP	225
000CDD58	666	000CDY27	692	007CH	710	016MR	225
000CDD5Q	645	000CDY39	693	007RO	875	016PM	775
000CDD62	671	000CDY56	693	007SR	707	016SR	708
000CDD69	671	000CDY63	683	008BA	548	017SR	708
000CDD91	655	000CDY65	691	008BC	496, 921	020CH	60, 67, 81, 89, 862
000CDD92	651	000CDY67	692	008BN	496, 920	020CM	485
000CDF15	642	000CDYR6	694	008BY	481, 496, 767, 784, 920	020CR	485
000CDF16	653	000CDYR9	694	008DM	767, 921	020DK	485
000CDF31	648	000F5	203	008RO	496, 876	020HM	784
000CDF44	648	000M1	202, 205, 970	008SR	965	020IP	485
000CDF50	642	000M2	968, 969	009BA	549	020MA	485
000CDF51	653	000M3	967	009BC	922	020MP	485
000CDF61	628	000M4	966	009BN	496, 921	020MR	485
000CDF65	628	000M5	969	009BV	922	020PG	485
000CDF6A	987	000M7	971	009BY	59, 66, 100, 112, 132, 136, 481, 496, 922	020RG	485
000CDF6C	987	001CY	964	009RO	496, 876	021CH	60, 67, 81, 89, 862
000CDF6E	987	001SR	964	009SR	965	021CM	487
000CDG22	501	002RO	874	009BA	549	021CR	487
000CDJ08	157, 899	003BC	914	009BC	922	021DK	487
000CDJ082B	157, 936	003BN	496, 914	009BN	496, 921	021IP	487
000CDJ082Y	157, 936	003BV	915	009BY	922	021KP	497
000CDJQ82B	157, 369, 942	003BY	59, 66, 79, 88, 100, 109, 112, 123, 127, 132, 136, 496, 767, 914	009RO	496, 876	021MA	487
000CDJQ82Y	157, 369, 942	003DM	767, 915	010BA	550	021MP	487
000CDJQ8RO	157, 910						
000CDPB3M8	988						
000CDQ02	371, 758						

Indice per codice - Item index

Codici	Pagine	Codici	Pagine	Codici	Pagine	Codici	Pagine
021MR	487	030MPP30	197	037HM	780	040MS	57, 66, 73, 87, 100, 106, 112, 120, 126, 131, 132, 134, 136, 139, 140, 506
021RG	487	030MR	229, 754	037KP	944	040PM	743
022BN	169, 369, 923	030PG	229, 753	037KT	960	043CR	84, 238
022BY	169, 369, 924	030PI	737	037MA	51, 62, 235	043DK	84, 238
022CH	60, 67, 81, 89, 101, 124, 127, 862	030PM	741, 742, 743, 744, 745, 746, 747, 751	037MP	51, 62, 235	043MA	84, 238
022CM	488	030PW	229, 753	037MR	51, 62, 235	043MP	84, 238
022CR	488	030RG	229, 753	037MS	505	043MR	84, 238
022DK	488	030RW	229, 753	037PM	777	046CR	56, 62, 78, 84, 104, 239
022IP	488	030SE	229	037PW	235	046DK	56, 62, 78, 84, 136, 239
022KP	497	030SG	229	037RW	235	046MA	56, 62, 78, 84, 104, 239
022MA	488	030VC	747	038CR	993	046MP	56, 62, 78, 84, 239
022MP	488	030VY	747	038DK	993	046MR	56, 62, 78, 84, 135, 136, 239
022MR	488	031/FHM416	778	038MA	993	048CP	700
022RO	169, 877	031/FHM416/F1	778	038MP	993	048CP00Q	701
023CM	489	031CB	858	038MR	993	048PF	65, 100, 558
023CR	489	031CR	231	039KP	945	048PI	700, 701
023DK	489	031DK	25, 231, 233	040BN	925	048PP	65, 559
023IP	489	031HM	778	040BY	59, 66, 925	048PR	58, 65, 100, 559
023MA	489	031MA	231	040CR	47, 62, 72, 84, 92, 98, 104, 110, 114, 115, 125, 132, 134, 136, 138, 140, 237	049CR	62, 84, 98, 110, 241
023MR	489	031MP	25, 231, 233	040DK	47, 62, 72, 84, 92, 98, 104, 110, 115, 125, 130, 132, 134, 136, 138, 140, 237	049DK	48, 62, 74, 84, 96, 98, 105, 110, 241
024RO	877	031MR	25, 231, 233	040KC	957	049KP	945, 946
024SP	495	031PM	741, 742, 744, 745, 746, 776, 777	040KM	957	049MA	62, 74, 84, 98, 110, 241
025RO	878	031PW	231	040KP	945	049MP	48, 62, 84, 98, 110, 241
026DK	227	031RD	778, 780	040KT	961	049MR	48, 62, 74, 84, 96, 98, 105, 110, 241
026IP	227	031RS	778, 780	040LD	507	049TK	241
026KP	944	031RW	231	040MA	47, 62, 72, 84, 92, 98, 104, 110, 114, 125, 132, 134, 136, 138, 140, 237, 856, 857	050BN	925
026MP	227	032CR	991	040MD	57, 66, 73, 87, 97, 100, 106, 112, 120, 126, 131, 132, 136, 139, 140, 507	051PI	697
026MR	227	032DK	991	040MM	855	052BN	926
026SE	227	032MA	991	040MP	46, 62, 72, 84, 92, 98, 104, 110, 114, 125, 132, 134, 136, 138, 140, 237	052BY	926
026SG	227	032MP	991	040MR	46, 62, 72, 84, 92, 98, 104, 110, 114, 125, 130, 132, 134, 136, 138, 140, 237, 237	052NN	764
027AKC	996	032MR	991	040MA	47, 62, 72, 84, 92, 98, 104, 110, 114, 125, 132, 134, 136, 138, 140, 237, 856, 857	053CR	69, 89, 102, 119, 127, 465
027AKM	996	033SP	852	040MM	855	053MA	69, 89, 102, 119, 127, 465
027BKC	996	034BN	994	040MP	46, 62, 72, 84, 92, 98, 104, 110, 114, 125, 132, 134, 136, 138, 140, 237	053PF	465
027BKM	996	034BY	994	040MR	46, 62, 72, 84, 92, 98, 104, 110, 114, 125, 130, 132, 134, 136, 138, 140, 237, 237	053PP	69, 102, 465
027BN	994	034RO	994	040ND	57, 66, 73, 87, 97, 100, 106, 112, 120, 126, 131, 132, 136, 139, 140, 507	053PR	53, 69, 76, 77, 89, 102, 119, 127, 465
027BY	994	035BN	995	040MD	57, 66, 73, 87, 97, 100, 106, 112, 120, 126, 131, 132, 136, 139, 140, 507		
027CR	991	035BY	995	040ND	57, 66, 73, 87, 97, 100, 106, 112, 120, 126, 131, 132, 136, 139, 140, 507		
027KP	996	035K	997	040ND	57, 66, 73, 87, 97, 100, 106, 112, 120, 126, 131, 132, 136, 139, 140, 507		
027MA	991	035MS	504	040ND	57, 66, 73, 87, 97, 100, 106, 112, 120, 126, 131, 132, 136, 139, 140, 507		
027MP	991	036BN	995	040ND	57, 66, 73, 87, 97, 100, 106, 112, 120, 126, 131, 132, 136, 139, 140, 507		
027MR	991	036BY	995	040ND	57, 66, 73, 87, 97, 100, 106, 112, 120, 126, 131, 132, 136, 139, 140, 507		
027RO	994	036KC	957	040ND	57, 66, 73, 87, 97, 100, 106, 112, 120, 126, 131, 132, 136, 139, 140, 507		
030DK	229	036KM	957	040ND	57, 66, 73, 87, 97, 100, 106, 112, 120, 126, 131, 132, 136, 139, 140, 507		
030HM	779	036SP	852	040ND	57, 66, 73, 87, 97, 100, 106, 112, 120, 126, 131, 132, 136, 139, 140, 507		
030LD	68, 87, 101, 121, 126, 727, 737	037BN	924	040ND	57, 66, 73, 87, 97, 100, 106, 112, 120, 126, 131, 132, 136, 139, 140, 507		
030MD	57, 68, 87, 101, 121, 126, 727, 737	037BY	924	040ND	57, 66, 73, 87, 97, 100, 106, 112, 120, 126, 131, 132, 136, 139, 140, 507		
030MP	229, 754	037CR	51, 62, 235	040ND	57, 66, 73, 87, 97, 100, 106, 112, 120, 126, 131, 132, 136, 139, 140, 507		
		037DK	51, 62, 235	040ND	57, 66, 73, 87, 97, 100, 106, 112, 120, 126, 131, 132, 136, 139, 140, 507		

Indice per codice - Item index

Codici	Pagine	Codici	Pagine	Codici	Pagine	Codici	Pagine
053TK	69, 89, 102, 465	069CR	52, 69, 76, 89, 102, 106, 112, 119, 127, 449, 451, 453, 454, 455, 456, 457	077CR	993	101DK	259
055BC	927	069DK	52, 69, 76, 77, 89, 94, 95, 102, 106, 112, 119, 127, 449, 451, 453, 454, 455, 456, 457	077DK	993	101KC	958
055BY	767, 926	069MA	52, 69, 76, 89, 102, 106, 112, 119, 127, 449, 451, 453, 454, 455, 456, 457	077KC	997	101KM	958
055DM	767, 927	069MB	859	077KM	997	101KP	947
055PF	566	069MP	52, 69, 76, 77, 89, 94, 95, 102, 106, 112, 119, 127, 449, 451, 453, 454, 455, 456, 457	077KP	997	101MA	259
055PP	567	069MR	52, 53, 69, 76, 77, 89, 94, 95, 102, 106, 112, 118, 127, 449, 451, 453, 454, 455, 456, 457	077MA	993	101MP	259
055PR	58, 65, 80, 86, 100, 567	070CR	249	077MP	993	101MR	259
060BN	927	070DK	249	077MR	993	102MD	449, 451
061CR	222, 242	070KM	958	077SP	853	102MS	449, 451
061DK	242	070MA	249	079CR	252	104CR	261
061MA	242	070MP	249	079DK	252	104DK	261
061MP	242	070MR	249	079MA	252	104HM	780
061MR	242	070PG	249	079MP	252	104MA	261
062BM	782	070PW	249	079MR	252	104MP	261
062BN	768	070RG	249	080CR	253	104MR	261
062BY	59, 67, 88, 100, 768, 782	070RO	249	080DK	253	105MT	796
062DM	67, 88, 100, 767, 782	070RW	249	080MA	253	106MT	797
062RO	769, 781, 878	070SP	61, 67, 81, 89, 101, 124, 127, 853	080MP	63, 253, 255	109MT	797
063CT	848	071CT	844	080MR	55, 63, 253	111LS	510
063DK	243	071RO	126	081LD	508	111MS	510
063KC	957	072CT	845	081MS	508	111MV	510
063MP	243	073CT	846	082CR	462	112LD	511
063MR	243	073DK	251	082DK	462	112MD	511
063PI	713	073IN	846, 847	082MA	462	112MV	511
063SE	243	073MR	51, 63, 79, 84, 98, 251	082MP	462	114MT	60, 67, 81, 89, 101, 124, 127, 798
063SG	243	074CT	847	082MR	462	119DK	263
063SP	61, 67, 101, 763, 853	074RO	203, 878	086MB	859	119MP	263
066CR	245	075CT	847	093DK	254	119MR	149, 167, 263
066DK	245	075IN	847	093MR	55, 63, 83, 84, 97, 98, 107, 110, 254	119PN	764
066HM	779	075PF	582	094DK	85, 140, 255	119RW	149, 167
066KP	947	075PP	583	094MP	63, 79, 85, 115, 125, 144, 146, 255	119SE	263
066MA	245	075PR	583	094MR	51, 63, 79, 85, 125, 138, 140, 144, 146, 255	119SG	263
066MP	245	075RO	202, 879	097CM	491	11DBN	931
066MR	245			097CR	257	11DBY	931
066PG	245			097DK	257	11DRO	884
066PW	245			097IP	491	120PN	60, 67
066RG	245			097MA	257	121DK	265
066RW	245			097MP	257	121MP	265
067CR	62, 247			097MR	257, 491	121MR	150, 165, 265
067DK	62, 247			097PF	491, 584	121PN	60, 67, 81, 89, 101, 123, 127, 139, 140, 800
067MA	62, 247			097SP	854	121RW	150, 165
067MP	247			097TK	257	121SE	265
067MR	55, 62, 247			098RO	879	121SG	265
067TK	247			0B7BV	932	122DK	266
068BN	928			0B7BY	932	122MP	266
068BY	928			100RO	913	122MR	266
				101CR	259	122PN	60, 67, 81, 89, 800
						122SE	266

Indice per codice - Item index

Codici	Pagine	Codici	Pagine	Codici	Pagine	Codici	Pagine
122SG	266	128DK	281	136DK	301	144SE	317
123DK	267	128MP	281, 756	136MP	301	144SG	317
123MP	267	128MR	281, 756	136MR	301	145DK	319
123MR	267	128PG	755	136PN	802	145MP	319
123PN	801	128PM	749, 750, 752	136SE	301	145MR	319
123SE	267	128PN	1000	136SG	301	145PN	1002
123SG	267	128PW	755	137CR	303	145SE	319
124BA	370, 554	128RG	281, 755	137DK	63, 85, 110, 303	145SG	319
124DK	269, 270, 271, 272, 273	128RW	281, 755	137KC	958	146PN	1002
124DW	212, 213	128SE	281	137KM	958	149PN	1002
124GW	214	128SG	281	137KM	958	150DK	324
124KT	717	128VC	749, 750	137MA	303	150MP	324
124LD	716	128VY	749, 750	137MP	110, 303	150MR	324
124MD	370, 716	129DK	283	137MR	55, 63, 83, 85, 105, 110, 303	150PN	1002
124MP	269, 270, 271, 272, 273	129MP	283	137PN	803	150SE	324
124MR	153, 156, 168, 269, 270, 271, 272, 273	129MR	283	138PN	1001	150SG	324
124NN	765	129SE	283	139DK	305	151CR	321
124NO	178, 368, 369	129SG	283	139DK	305	151DK	321
124PF	370, 588	130DK	285, 287, 289	139MP	305	151MA	321
124PN	371, 801	130KP	947, 948	139MR	305	151MP	321
124PP	589	130LD	537, 539	139SE	305	151MR	321
124PR	589	130MD	537, 539	139SG	305	151PN	1002
124RO	166, 168, 879	130MP	285, 287, 289	140DK	307	152PN	1002
124RQ	168	130MR	151, 285, 287, 289	140MP	307	153PN	803
124RW	153, 156	130MV	537	140MR	307	154PN	1003
124SE	269, 270, 271, 272, 273	130PM	748, 802	140PN	1001	156PN	1003
124SG	269, 270, 271, 272, 273	130RW	151	140SE	307	157PN	803
124SW	214	130SE	285, 287, 289	140SG	307	159CR	323
125DK	275	130SG	285, 287, 289	141DK	309	159DK	323
125MP	275	130VC	748	141MP	309	159KP	948
125MR	275	130VY	748	141MR	309	159MA	323
125PN	1000	131DK	291	141PN	1001	159MP	323
125SE	275	131MP	291	141SE	309	159MR	323
125SG	275	131MR	291	141SG	309	159PN	804
126DK	277	131PN	1000	142DK	311, 312	159RW	323
126MP	277	131SE	291	142MP	311	160KM	959
126MR	277	131SG	291	142MR	311, 312	160MD	121, 126, 512
126PN	802	132PN	1000	142RQ	311	161PN	1003
126SE	277	133DK	293, 295	142RW	311	164CR	325
126SG	277	133MP	293, 295	142SE	311, 312	164DK	325
127DK	63, 85, 117, 125, 279	133MR	293, 295	142SG	311, 312	164MA	325
127MP	117, 125, 279	133PN	1000	143DK	313, 315	164MP	325
127MR	55, 63, 83, 85, 117, 125, 279	133SE	293, 295	143MP	315	164MR	325
127SE	125, 279	133SG	293, 295	143MR	313, 315	164PW	325
127SG	125, 279	134DK	297, 299	143PN	1001	164RW	325
		134MP	297, 299	143RQ	315	165PN	804
		134MR	297, 299	143RW	315	166CR	56, 63, 85, 98, 327
		134PN	1001	143SE	313, 315	166DK	56, 63, 85, 98, 327
		134SE	297, 299	143SG	313, 315	166KP	949
		134SG	297, 299	144DK	317		
		135PN	1001	144MP	317		
				144MR	317		

Indice per codice - Item index

Codici	Pagine	Codici	Pagine	Codici	Pagine	Codici	Pagine
166MA	56, 63, 85, 98, 327	174SE	70	185MS	514, 515	194SG	359
166MP	56, 63, 85, 98, 327	174SG	70	185MV	515	195DK	361
166MR	56, 63, 85, 98, 327	175DK	338, 733	185SE	349	195FE	828
166PN	804	175LD	733	185SG	349	195MP	361
166SP	854	175MD	733	186KP	949	195MR	361
167CR	49, 63, 85, 98, 329	175MP	338	186LS	516	195SE	361
167DK	49, 63, 78, 85, 98, 329	175MR	338	186MS	516	195SG	361
167MA	49, 63, 85, 98, 329	175PM	744, 745, 746	186MV	516	196DK	363
167MP	49, 63, 78, 85, 98, 329	175SE	338	188SG	351	196IN	859, 860
167MR	49, 63, 78, 85, 98, 329	175SG	338	188DK	351	196MB	860
168CR	69, 459	178DK	339	188KP	950	196MP	363
168DK	54, 69, 459	178MP	339	188SE	351	196MR	363
168MA	69, 459	178MR	339	188MP	351	196SE	363
168MP	69, 459	178SE	339	188MR	79, 85, 351	196SG	363
168MR	54, 69, 459	178SG	339	189CR	49, 64, 73, 85, 99, 107, 110, 353	197DK	365
171DK	25, 116, 125, 331, 333, 469	179CR	340	189DK	49, 64, 73, 85, 93, 99, 107, 110, 353	197MP	365
171HM	779	179DK	340	189KM	959	197MR	365
171KP	766, 949	179MA	340	189MA	49, 64, 73, 85, 99, 107, 110, 353	197SE	365
171LD	721	179MP	340	189MP	49, 64, 85, 93, 99, 110, 353	197SG	365
171MD	721	179MR	340	189MR	49, 64, 73, 85, 93, 99, 107, 110, 353	198FE	828
171MP	25, 116, 125, 331, 333, 469	181KP	997	190CR	50, 64, 75, 86, 99, 107, 110, 134, 136, 219, 220	198KP	951
171MR	25, 116, 125, 331, 333, 469	182CR	341	190MA	50, 64, 75, 86, 99, 110, 857	199DK	163, 367
171PM	480	182DK	341	190MR	856	199FE	828
171PW	469	182MA	341	190TK	50, 64, 86, 99	199MR	163, 367, 368
171RW	469	182MP	341	191CR	355	199RO	880
171SE	116, 125, 331, 333, 469	182MR	341	191DK	50, 64, 75, 85, 99, 355	199RQ	163, 367
171SG	116, 125, 331, 333, 469	183/FHM416	778	191MA	355	199SE	163, 367
172CR	54, 70, 460	183/FHM416/F1	778	191MM	856	199SG	163, 367
172DK	54, 70, 460	183CR	343	191MP	50, 64, 75, 85, 99, 355	200BN	929
172MA	54, 70, 460	183DK	25, 343, 345	191MR	50, 64, 75, 85, 99, 355	200FE	829
172MP	54, 70, 460	183HM	778	191TK	355	200MD	121, 126, 513
172MR	54, 70, 460	183MA	343	192DK	357	200RO	880
173DK	335, 337	183MP	25, 343, 345	192MP	357	202BC	930
173LD	722	183MR	25, 343, 345	192MR	357	202BN	929
173MD	722	183PM	741, 742, 744, 745, 746	192SE	357	202BY	59, 66, 79, 88, 100, 109, 112, 123, 127, 132, 136, 140, 930
173MP	335, 337	183PG	343	192SG	357	202FE	829
173MR	335, 337	183PW	343	194DK	359	202MB	860
173SE	335, 337	183RG	343	194MP	359	202RO	880
173SG	335, 337	183RW	343	194MR	359	203FE	482
174DK	53, 70, 461	184CR	347	194SE	359	203RO	881
174MP	53, 54, 70, 461	184DK	347	194MP	359	204BY	930
174MR	52, 70, 461	184LD	509	194MR	359	204FE	482
		184MA	347	194MR	359	204RO	881
		184MD	509	194MR	359	205FE	830
		184MP	347	194MR	359	206BN	931
		184MR	347	194MR	359	206RO	881
		184MV	509	194MR	359	207RO	882
		185DK	349	194MR	359	209TP	740
		185LS	515	194MR	359	210KP	952
		185MP	349	194MR	359		
		185MR	349	194MR	359		

Indice per codice - Item index

Codici	Pagine	Codici	Pagine	Codici	Pagine	Codici	Pagine
211CT	848	234DK	382	2745G	394	313MD	57, 68, 88, 102, 723, 725
212CT	848	234MP	382	275DK	395	313PI	68, 88, 102, 714, 735
213CT	848	234MR	382	275MR	395	315KT	961
214CT	848	234SE	382	275SE	395	315MS	518
215CT	848	234SG	382	275SG	395	316KT	961
223DK	372	236DK	383	276HM	780	316MS	519
223MP	372	236MP	383	279PA	790	317MD	493
223MR	372	236MR	383	280PA	790	318LS	520
223SE	372	236SE	383	284PA	465	318MS	520
223SG	372	236SG	383	285PA	465	318MV	520
224DK	373	237DK	384	288DK	396	319LS	521
224KP	953	237MP	384	288MP	396	319MS	57, 131, 132, 521, 523
224MP	373	237MR	384	288MR	396	319MV	521
224MR	373	237SE	384	288SE	396	320MS	120, 126, 524, 525
224SE	373	237SG	384	288SG	396	325LS	522
224SG	373	238DK	385	290PA	791	325MS	120, 126, 522
225DK	125, 375	238MP	385	295PA	791	325MV	522
225MP	115, 125, 375	238MR	385	296PA	791	326LS	523
225MR	125, 375	238SE	385	297PA	792	326MS	523
225SE	125, 375	238SG	385	298PA	792	326MV	523
225SG	125, 375	248KP	952	300PA	792	327LS	526
226DK	376	250MR	386	301PT	863	327MS	526
226MP	376	251DK	387	302LD	717	327MV	526
226MR	376	251MP	387	302MD	717	327TP	820
226SE	376	251MR	387	302PA	793	329MS	493
226SG	376	251SE	387	303LD	719	330LS	529
228DK	377	251SG	387	303MD	719	330MS	528, 529
228MP	377	252DK	388	303PA	793	330TU	813
228MR	377	252MP	388	304PA	793	331LD	537, 539
228SE	377	252MR	388	305LD	729, 731	331MD	537, 539
228SG	377	252PI	695	305MD	729, 731	331MV	537
229DK	378	252SE	388	305PA	60, 67, 81, 89, 101, 794	331TU	813
229MP	378	252SG	388	306LD	730, 732	332LD	543
229MR	378	265KP	194, 953	306MD	730, 732	332MD	543
229SE	378	271DK	389	307LD	68, 87, 101, 734	332MV	543
229SG	378	271MP	389	307MD	57, 68, 73, 87, 101, 734	332TU	813
230DK	379	271MR	389	308LD	126, 728	334LS	527
230MP	379	272DK	117, 125, 391	308MD	121, 126, 728	334MS	527
230MR	379	272MP	117, 125, 391	309LD	736	334MV	527
230SE	379	272MR	117, 125, 391	309MD	736	335LS	530
230SG	379	272SE	125, 391	309MT	798	335MS	530
232DK	380	272SG	125, 391	311LD	724, 726	335MV	530
232MP	380	273DK	393	312LD	517	335TU	813
232MR	380	273MP	393	312MD	517	336DK	397
232SE	380	273MR	393	313KT	714, 735	336MR	397
232SG	380	273SE	393	313LD	68, 88, 102, 723, 725	336SE	397
233DK	381	273SG	393			336SG	397
233MP	381	274DK	394			337DK	399
233MR	381	274MP	394				
233SE	381	274MR	394				
233SG	381	274SE	394				

Indice per codice - Item index

Codici	Pagine	Codici	Pagine	Codici	Pagine	Codici	Pagine
337MR	399	362MD	543	425MP	416	498NN	783
337SE	399	362MV	543	425MR	155, 416	498NO	495
337SG	399	370DK	407	425MS	370, 535	498SP	495, 783
337TU	813	370MR	407	425RW	155	4Q6RO	888
338MS	531	370SE	407	425SE	416	502NN	764
339MS	57, 82, 531	370SG	407	425SG	416	503NN	764
341LD	537	381MT	495	426DK	417	503NO	60, 68, 82, 88, 101, 109, 112, 124, 127, 140, 157, 169, 183, 369, 371, 479, 482
341MD	537	382CR	409	426LD	718	504CP	665
341MV	537	382DK	409	426MD	718	506CP	61, 68, 88, 101, 109, 112, 127, 660
342DK	400	382MA	409	426MP	417	506CP00A	660
342LD	543	382MP	409	426MR	417	508CP	61, 68, 82, 88, 97, 101, 109, 112, 124, 127, 641
342MD	543	382MR	409	426NT	817	508CP00F	642
342MR	400	382PF	604, 605	426SE	417	508CP00Q	643
342MV	543	382RO	882	426SG	417	508CPQ70	620
342SE	400	38DBN	931	427DK	419	512CT	849
342SG	400	38DBY	931	427MR	419	512NN	765
343DK	401	38DRO	886	427RQ	419	512NO	181
343MR	401	406RO	882	427SE	419	512SP	763, 855
343SE	401	410AT	47, 50, 64, 75, 86, 99, 107, 110, 115, 125, 134, 136, 219, 222	427SG	419	513NO	479, 482
343SG	401	410NL	221	428DK	421	514CP	61, 68, 88, 101, 662
345PF	591, 774	411NL	47, 50, 64, 75, 86, 99, 107, 110, 115, 125, 134, 136, 219, 222	428MR	421	514SP	855
345PP	594	411NT	47, 50, 64, 75, 86, 99, 107, 110, 115, 125, 134, 136, 219, 222	428RQ	421	515CP	667
345PR	594	413AT	220	428SE	421	515MT	799
346PF	122, 126, 593	413NT	220	428SG	421	516MT	799
346PP	595	414MR	858	429DK	423, 424	518CP	112, 650
346PR	122, 126, 595	415CB	858	429MP	423, 424	518MT	799
347DK	403	416ML	883	429MR	152, 166, 423, 424	519CP	61, 68, 82, 88, 101, 109, 112, 127, 647
347MP	403	416RO	883	429PI	700	519CP00F	648
347MR	403	422DK	411	429RQ	152, 166, 423	520PI	61, 68, 82, 88, 102, 109, 112, 124, 127, 691
347PF	597	422MP	411	429RW	152, 166	521PI	692
347SE	403	422MR	154, 411	429SE	423, 424	522PI	705
347SG	403	422RW	154	429SG	423, 424	523PI	705
348DK	405	422SE	411	431CA	786	524CP	703
348MP	405	422SG	411	432MR	425	524PI	61, 68, 82, 88, 97, 102, 109, 112, 124, 127, 683
348MR	405	423DK	413, 415	433LD	541	524RO	698
348PF	599	423LD	541	433MD	541	525PI	61, 68, 82, 88, 97, 102, 109, 112, 124, 127, 698
348SE	405	423MD	541	434MR	426		
348SG	405	423MP	413, 415	436MR	427		
351MS	532	423MR	413, 415	437TP	820		
353MD	534	423SE	413, 415	446TP	820		
354PF	600	423SG	413, 415	447TP	821		
354PP	601	425DK	416	450CI	788		
354PR	601	425LS	535	451CI	788		
355MS	533			452CI	788		
355PF	370, 602			453CI	788		
355PR	603			454CI	788		
356BA	553			455CI	788		
361LD	537			490CI	789		
361MD	537			491CI	789		
361MV	537			492CI	789		
362LD	543			493CI	789		

Indice per codice - Item index

Codici	Pagine	Codici	Pagine	Codici	Pagine	Codici	Pagine
526PI	704	575CP00Q	633	624GA	796	683SU	812
527PI	704	575CP518	634	627SU	806	698VM	816
529CP	703	575CPQ70	621	628RO	884	701DK	471
529PI	61, 68, 88, 102, 109, 112, 685	576CP	635	628SU	807	701MP	471
530PI	702	576CP00Q	636	629SU	807	701MR	471
531CA	60, 67, 81, 89, 101, 124, 127, 786	577CP	637	630SU	807	701PM	480
531PI	705	577CP00Q	638	631IN	841	701PW	471
532PI	704	578CP	639	631SU	808	701RW	471
533PI	704	578CP00Q	640	631TV	841	701SE	471
534PI	687	580CP	696	632IN	841	701SG	471
535CPB00	670	581CP	696	632TV	841	702DK	473, 476
535CPC00	670	582CP	696	633CN	827	702MP	473
535PI	482, 693	592FE	831	634CN	827	702MR	473, 476
536CPB00	671	593FE	831	636CN	827	702NP	814
536CPC00	671	594FE	832	637DD	769, 863	702PM	480
536PI	703	595FE	832	638DD	769, 863	702PW	473
538CP	644	596FE	832	639IN	67, 88, 101, 840, 844	702RW	473
538CP00Q	645	596VM	832	639TV	67, 89, 101, 840	702SE	473
540CP	651	598FE	833	640SU	808	702SG	473
540CP00Q	650	599VM	816	641VM	817	703DK	475
542CP	649	600FE	833	642VM	817	703MP	475
543CP	702	601FE	833	643VM	817	703MR	475
543CP00Q	702	602FE	835	645VM	817	703PM	480
544CP	663	603FE	834	646IN	67, 81, 88, 96, 101, 123, 127, 139, 140, 843	703PW	475
545CP	668	603IN	834	646TP	371, 821	703RW	475
550CI	67, 89, 101, 127, 789	603SP	854	646TV	67, 81, 88, 96, 101, 123, 127, 139, 140, 843	703SE	475
551CI	789	604IN	835	647GA	826	703SG	475
552CI	60, 81, 124, 789	604NZ	835	647TP	371, 821	704DK	477
552CP	672	605IN	837	648GA	826	704MR	477
553CI	789	605NZ	837	649RU	788	704RW	477
553CP	666	606FE	829	650RU	788	705DK	478
554CP	664	607FE	830	653SU	808	705MR	478
555CP	669	608GA	794	654SU	809	705NP	814
556CP	661	609GA	794	655SU	809	705NU	815
559CP	652	60RRO	887	656SU	809	706BY	761
559CP00F	653	610GA	795	658NL	810	706NU	816
559CP00Q	654	612GA	795	661NZ	836	709BY	761
560CP	655	613GA	795	662NZ	836	714LP	814
560CP00Q	656	614GA	999	663NZ	836	717LE	815
56DML	886	614IN	839	664NZ	836	717LP	815
56DRO	886	614NZ	839	666NL	810	720TP	822
570CP	646	615PA	999	670FE	830	721TP	822
573CP	627	616GA	999	674SU	810	722TP	818
573CP00F	628	616NZ	836	675SU	811	723TP	822
573CP00Q	629	617GA	999	676SU	811	725TP	823
574CP	630	618GA	999	677SU	811	726TP	823
574CP00Q	631	619GA	999	678SU	812	728TP	824
575CP	632	620GA	826			729TP	482
		622SU	806			731CA	787
		623RO	883			73DRO	887
		623SU	806			73RRO	887

Indice per codice - Item index

Codici	Pagine	Codici	Pagine	Codici	Pagine	Codici	Pagine
747TP	823	873CP00Q	370, 626	B+40V3037PS3F	978	B006G1160**3E	981
757TP	824	875CP	658	B+40V3040GS3F	978	B006G3050**3E	981
800CE	849	877CP	659	B+40V4050PS	978	B006G3080**3E	981
800DK	48, 64, 74, 86, 99, 105, 111, 126, 429	8D6RO	889	B+40V4060PS	978	B006G4	972, 987
800MP	48, 64, 86, 99, 111, 126, 142, 146, 429	900DK	48, 64, 74, 86, 99, 105, 111, 431	B+40V4065PS	978	B006IN	710
800MR	48, 64, 74, 86, 96, 99, 105, 111, 116, 126, 142, 146, 429	900MP	48, 64, 86, 99, 111, 143, 146, 431	B+40V4070PS	978	B006M9105**3D	978
800SE	64, 86, 99, 111, 429	900MR	48, 64, 74, 86, 96, 99, 105, 111, 143, 146, 431	B+40V4085PS	978	B006PT	709
800SG	64, 86, 99, 111, 429	900SE	64, 86, 99, 111, 431	B+40V4090PS	978	B006R1007153A	981
801CE	849	900SG	64, 86, 99, 111, 431	B+48V9038PS3D	978	B006R1007203A	981
801CP	622	914CP	678	B+50V3040PS3D	978	B006R1008153A	981
801CP00Q	623	916ML	885, 889	B+50V3045PS3D	978	B006R1008303A	981
802CE	850	916RO	885	B+50V3050PS3D	978	B006R2007214C	982
802PI	681	920KP	951	B+50V3055PS3D	978	B006R2008104C	982
803CE	850	935CPB00	675	B+60V4105GS	978	B006R2008294C	982
803PI	701	935CPC00	674	B0003M000**3E	977	B007F1065**3E	769, 971
804CE	850	944CP	679	B0004M000**3E	977	B007F6075**3D	973
805PI	689	950CPC00	676	B000B3008	980, 988	B007F6105**3D	973
806RO	884	951CPC00	677	B000B3010	980	B007F6120**3D	973
808CP	657	952CP	673	B000C1005**3D	981	B007F6130**3D	973
808PI	688	954CP	680	B000C1006**3D	981	B007F6170**3D	973
809CE	851	99DML	888	B000C10Q6**3D	981	B007F6M10**3A	973
810CE	851	99DRO	888	B000C10Q7**3D	981	B007F8095**3D	974
811CE	851	9Q6RO	889	B000C10Q8**3D	981	B007F8105**3D	770, 974
812CE	851	A21AN	191	B000C17Q8**3D	981	B007F8120**3D	770, 974
813CE	851	A24AN	191	B000P1000003D	772, 976	B007R1008203A	981
814CE	851	A25AN	192	B000P2000003D	772, 976	B007R1008303D	981
815CE	851	A52RO	890	B000P200P003D	976	B007R2008104C	982
816ML	885	A54HR	762	B000P2030003D	976	B007R2008304C	982
816RO	885	A54PF	564	B000P3080003D	773, 976	B0085M000**4A	977
820AN	61, 68, 88, 185, 186, 187	A54PP	565	B000P3100003D	773, 976	B008F1055**3E	769, 971
821AN	61, 68, 88, 138, 140, 185, 186, 188	A54PR	565	B000P4080003D	773, 976	B008F1062CG3D	971
826PI	689	A62RO	890	B000P5000003D	773, 976	B008F1065**3E	769, 971
828AN	61, 68, 81, 88, 96, 101, 106, 112, 120, 127, 189	A64RO	890	B000P6000001C	977	B008F1080**3E	769, 971
829AN	61, 68, 81, 88, 96, 101, 106, 112, 120, 127, 138, 140, 190	A67RO	891	B001FM012**3E	977	B008F1092CG3D	971
831AN	192	B-40B1030TG	980	B004R2008104C	982	B008F1095**3E	769, 971
831CA	787	B-40V3075GS3F	978	B005F6065**3D	973	B008F1105**3E	769, 971
839AN	189	B-40V3110GS3F	978	B005F6075**3D	973	B008F1125**3E	769, 971
873CP	625	B+25V1016PS3E	978	B005G1050**3E	981	B008F5090**3D	972
		B+25V1020PS3E	978	B005G1080**3E	981	B008F6065**3D	973
		B+29V9016PS3D	978	B005R2008104C	982	B008F6070**3D	973
		B+35V1020GS3F	978	B006F6045**3D	973	B008F6075**3D	973
		B+35V1025GS3F	978	B006F6075**3D	973	B008F6080**3D	973
		B+35V1030GS3F	978	B006F6080**3D	973	B008F60902T3D	972, 987
		B+40B1020TG	980	B006F6090**3D	973	B008F6095**3D	973
		B+40V3035PS3E6	978	B006F6100**3D	973	B008F60982T3D	987
				B006F6105**3D	973	B008F6100**3D	973
				B006F6120**3D	973	B008F61052T3D	972, 987
				B006G1050**3E	981	B008F6110**3D	973
				B006G1060**3E	981	B008F61202T3D	972, 987
				B006G1080**3E	981	B008F6130**3D	973
				B006G1100**3E	981		

Indice per codice - Item index

Codici	Pagine	Codici	Pagine	Codici	Pagine	Codici	Pagine
B008F6140**3D	973	B050V7070	711	BBASROR50	988	C08RO	765, 892
B008F6150**3D	973	B050V7070TC	760, 979	BF02FB070083D	771, 974	C09RO	892
B008F6200**3D	973	B050V7090	711	BF02FB070103D	771, 974	C15RO	893
B008F6M10***3A	973	B050V7090TC	760, 979	BF02FB070123D	771, 974	C24RO	208, 893
B008F8090**3D	974	B050V7110	711	BF02FB080083D	771, 974	C50PF	561
B008F8095**3D	770, 974	B050V7110TC	760, 979	BF02FB080103D	771, 974	C51PO	463
B008F8100**3D	770, 974	B050V7120	711	BF02FB090083D	771, 974	C51PR	463
B008F8105**3D	770, 974	B050V7120TC	760, 979	BF02FB090103D	771, 974	C55RO	765, 893
B008F8110**3D	770, 974	B060V6040**3D	979	BF02FB100083D	771, 974	C59PF	481, 575
B008F8115**3D	770, 974	B060V7070TC	760, 979	BF02FB100103D	771, 974	C59PO	575
B008F8120**3D	770, 974	B060V7080CR3A	979	BF02FB110083D	771, 974	C59PR	481, 573
B008F8130**3D	770, 974	B060V7080TC	760, 979	BF02FB110103D	771, 974	C62RO	766, 783, 894
B008F8140**3D	770, 974	B060V7090CR3A	979	BF02FB130083D	771, 974	C67RO	894
B008F8150**3D	770, 974	B060V7100TC	760, 979	BF02FB130103D	771, 974	C70RO	894
B008F8170**3D	770, 974	B060V7110TC	760, 979	BF03FB070083D	771, 975	C98PF	587
B008F9070***3D	770, 974	B100V6080**3E	979	BF03FB070103D	771, 975	C98PR	585
B008F9090***3D	770, 974	B162RN020045B	983	BF03FB080083D	771, 975	CD7BY	761, 781
B008M9105**3D	978	B162RP020043A	982	BF03FB080103D	771, 975	CD7RO	768, 781
B008R1009203A	981	B162RP020103A	982	BF03FB090083D	771, 975	COPBY	768, 781
B008R1010203A	981	B162RP020153A	982	BF03FB090103D	771, 975	CQ6RO	760, 910
B008R1085303A	981	B25CM	490	BF03FB100083D	771, 975	CQ8RO	371, 765, 910
B008R2009254C	982	B25DK	490	BF03FB100103D	771, 975	D05BK	933
B008T1080**3E	979	B25KP	497	BF03FB110083D	771, 975	D05BY	932
B008T1095**3E	979	B25MP	490	BF03FB110103D	771, 975	D05RO	895
B008T1110**3E	979	B25MR	490	BF03FB130083D	771, 975	D06BK	933
B008T1180**3D	979	B26DK	436	BF03FB130103D	771, 975	D06BY	933
B010B3014	980	B26MR	436	BF04QB070083D	771, 975	D06RO	895
B010F6070	711	B26SE	436	BF04QB080083D	771, 975	D08BC	934
B010F6080	711	B26SG	436	BF04QB090083D	771, 975	D08BN	934
B010F6115	711	B320B1*****1C	980	BF04QB100083D	771, 975	D08BY	934
B010F6150	711	B35MD	715	BF04QB110083D	771, 975	D08RO	895
B010T1090**3E	979	B36MD	715	BF04QB130083D	771, 975	D11BN	935
B010T1325**1C	979	B3DU1M030	977	BF10FB070083D	772, 975	D11BY	935
B012IN00S	709	B52HR	762	BF10FB080083D	772, 975	D11RO	896
B012PT	709	B52PF	562	BF10FB090083D	772, 975	D16ML	896
B012T1080**3E	979	B52PP	563	BF10FB100083D	772, 975	D16RO	896
B012T1120**3E	979	B52PR	563	BF10FB110083D	772, 975	D38BN	935
B015AE471**3D	982	B630F5750**3D	770, 972	BF10FB130083D	772, 975	D38RO	897
B015AE471**5A	982	B630F5850**3D	770, 972	BF11QB070083D	772, 975	D68BN	928
B016GP019.54D	982	B730F5840**3D	770, 972	BF11QB080083D	772, 975	D68BY	929
B016GP019104D	982	B730F5845**3D	770, 972	BF11QB090083D	772, 975	D73RO	897
B016GP021104D	982	B730F5890**3D	770, 972	BF11QB100083D	772, 975	D98RO	897
B016GR018064B	982	B740F5845**3D	770, 972	BF11QB110083D	772, 975	E51PO	463
B016GR020034B	982	B745F5845**3D	770, 972	BF11QB130083D	772, 975	E51PR	463
B016GR195064B	982	B76DK	196	BPLTPKSR6**4A	699	E56PF	65, 87, 100, 111, 122, 126, 132, 139, 140, 480, 569, 773, 774, 775
B016RP022025A	982	B76IP	196	BX40V5025BP3E	979	E56PO	65, 87, 100, 111, 569
B040B1025001C	980	B76MR	196	BZ40B1030TG	980	E56PP	570
B040B2020TG	980	B790F5845**3D	770, 972	BZ50B1012TP	980		
B040V6025**3D	979	B8DU1M020	977	C03RO	765, 891		
B045R2008104C	982	BB5BN	941	C06RO	760, 891		
B050V3050	202, 203	BB6BN	942	C07RO	892		

Indice per codice - Item index

Codici	Pagine	Codici	Pagine	Codici	Pagine	Codici	Pagine
E56PR	65, 80, 87, 100, 108, 111, 126, 132, 135, 136, 140, 570	J155G	433	Q26MR	437	T33BN	941
E57PF	66, 87, 100, 111, 145, 147, 571	J40DK	435	Q26PI	690	T33CB	439
E57PO	66, 87, 100, 111, 571	J40MR	435	Q26SE	437	T33DK	65, 136, 439
E57PP	145, 147, 572	K24PN	861	Q26SG	437	T33MA	65, 86, 439
E57PR	66, 80, 87, 100, 108, 111, 135, 136, 145, 147, 572	K90MD	861	Q28PI	686	T33MM	439
E59PF	575	L59PF	575	Q29PI	700	T33MR	55, 83, 86, 135, 136, 65, 439
E59PO	575	L59PO	575	Q30B1	825	T33RO	909
E59PR	573	N08BC	937	Q30PI	702	T33SP	83, 86, 439, 852
E60PF	66, 576	N08BN	936	Q30TP	371, 825	T33TK	86, 439
E60PO	66, 576	N08RO	899	Q35PI	482, 694	T36BN	941
E60PP	577	N16RO	899	Q46ML	904	T36CR	65, 441
E60PR	58, 66, 577	N61PF	58, 66, 87, 578	Q46RO	904	T36DK	65, 83, 86, 441
E62PF	492	N61PO	58, 66, 87, 578	Q48PI	701	T36MA	65, 441
E62PR	492	P08RO	900	Q50RO	903	T36MP	55, 65, 441
F24RO	898	P30KP	948	Q51PI	371	T36MR	55, 65, 83, 86, 104, 111, 115, 126, 135, 136, 441
F56RO	898	P48KP	952	Q56ML	904	T36RO	909
F62RO	898	P49KP	946	Q56RO	904	T42CR	443
F81KP	998	P52RO	900	Q65KP	195, 371, 954	T42DK	65, 443
G59PF	575	P62RO	900	Q70CPQ70	619	T42MA	443
G59PO	575	P64RO	901	Q70PI	618	T42MP	443
G71PF	122, 126, 580	P67RO	901	Q75RO	202, 905	T42MR	55, 65, 443
G71PO	580	P88KP	950	Q82PI	682	T88DK	65, 86, 445
G71PV	581	PLTRO806	884	Q83PI	701	T88MP	55, 65, 445
H56PF	58, 65, 80, 87, 97, 100, 108, 111, 122, 126, 130, 132, 136, 140, 569, 775	PLTRO4Q6	888	Q85PI	690	T88MR	55, 65, 83, 86, 105, 111, 117, 126, 135, 136, 445
H56PO	58, 65, 80, 87, 97, 100, 108, 111, 122, 126, 136, 140, 569	PLTRO8D6	889	Q86RO	905	T88SE	65, 445
H57PF	58, 66, 80, 87, 100, 108, 111, 130, 132, 136, 145, 147, 571	Q02RO	901	Q90KM	956, 959	T88SG	65, 445
H57PO	58, 66, 80, 87, 100, 108, 111, 136, 571	Q04BN	937	QD5RO	911	VF22F50TQ	171
H57PR	66	Q04BY	937	QD6ML	911	VF50F50TQ	160
H60PF	58, 66, 576	Q05RO	902	QD6RO	911	Y37KT	960
H60PO	58, 66, 576	Q08BC	939	QD8BN	943	Z61DK	446
J02NO	179	Q08BN	368, 476, 938	QD8BY	943	Z61MR	446
J04LD	720	Q08BY	368, 476, 938	QD8RO	911	ZES001	1007
J04MD	720	Q08DM	938	QN6BN	943	ZES002	1007
J15DK	433	Q08RO	902	QN6RO	912	ZES003	1007
J15MR	433	Q09BC	939	QP5RO	912	ZES003/01	1007
J15SE	433	Q09BN	476, 939	QP8RO	912	ZES004	1007
		Q09BY	476, 939	R35RO	994	ZES012	1007
		Q09PI	371	R36RO	995		
		Q09RO	902	R37RO	906		
		Q13KM	955	R40RO	906		
		Q13KT	714, 960	R46RO	906		
		Q13PI	714	R50RO	907		
		Q15RO	903	R52RO	907		
		Q19DK	479	R56RO	907		
		Q19MR	479	R71RO	580, 908		
		Q22BN	169, 368, 940	R73RO	908		
		Q22BY	169, 368, 940	R80RO	908		
		Q22RO	169, 903	S08BN	940		
		Q24PI	370, 684	S08RO	909		
		Q25PI	698	S97CM	495		
		Q26DK	437				

INDICE TEMATICO

tipo di articolo.....	pag.
acciaio inox.....	467
accoppiati - kit per coppie maniglioni per alzanti	711
accessori e info tecniche per alzanti scorrevoli.....	711
adattatori – Riduzioni e aumentatori per ferri quadri ...	981, 982
adattatori per DK	210
alluminio	484
alzanti scorrevoli – accessori e info tecniche	711
anello - seeger.....	982
antico - finitura ottone.....	45
anti-effrazione – dispositivi per finestre	200
anti-effrazione – dispositivi per porte	757
antigerm	37
anuba - cappucci per cerniere anuba	184
argento vecchio - finitura ottone	71
argento vecchio collection	71
articoli da ricambio	989
asse - bocchette con foro	765, 891, 892, 894
aste esterne - cremonesi, finali, passanti	219
baionetta - bocchette di sicurezza	761
basculanti - martelline per.....	858
barocco - serie maniglia.....	990
bassa - impugnatura per maniglia con collo basso	196, 226
battenti per porte d'entrata.....	545
blindate - articoli per porte.....	757
blister - confezioni.....	1008
blocco - maniglie da	859
bocchette	914
bocchette per cilindro con codolo.....	891, 765
bocchette di sicurezza - defender	758
bocchette per porte blindate	767, 781
borchie - chiodi a piramide.....	816
bronzo graffiato opaco 800 collection.....	113
brugola - viti – grani e chiavi	981, 984
bucal lettere	824
bussole e viti	980, 983
campanello - pulsante	818
campanello – targhetta porta nome	819
cancelli - maniglie per cancelli e serramenti in ferro ...	858
cappucci copricerniere	184
catenacci.....	844
catenelle.....	827
cerniere.....	850
certificazioni.....	8, 1039
chiavi d'ottone.....	862
chiodi a piramide	816
cieche - bocchette cieche..	914, 916, 918, 920, 921, 922, 927, 930, 934, 937, 939
cilindro e chiave - DK con	36, 204, 893, 894, 971
cilindro yale	964
codolo cilindro - bocchette e pomoli per.....	764, 783
collo basso - maniglie	196, 226
commerciali – specifiche commerciali	30
complanare – Maniglioni per porte e finestre complanari ...	215, 733
condizioni generali di vendita.....	1039
confezioni - packaging	1006
coppia martellina/maniglia.....	855
coppie pomolo.....	557
copriavvolgibile	786
coprichiave	862
copridadi e dadi.....	769, 863
coprinterruttori	788
corno - serie maniglia.....	990
corrimano - esempi di	805
corrimano - supporti per	806

tipo di articolo.....	pag.
corrimano - tubi per	813
cremonesi	32, 34
cremonesi per aste esterne.....	219
cricchetti sopra luce	839
distanze - interassi.....	31
dadi - copridadi	769, 863
defender - bocchette di sicurezza.....	758
dk stretto da 25 mm - movimento per rosetta	878, 969
DK 024 ferro autoregolante e a pressione	198
DK C67 e C70 con chiave e cilindro.....	36, 204, 894
DK Secureblock.....	200
DK - TK	211
doppia mappa –bocchette	767, 782, 915, 917, 919, 921, 927, 938
doppio ferro quadro	922
elementia – linea elementia	141
espansione - ferri.....	769, 971
espositori - pannelli.....	1007
fermapersiane.....	831
fermaporte.....	828, 836
fermaporte magnetico	830
ferri blocca pomoli	771, 974
ferri quadri DOPPI.....	972
ferri vari	769, 971
filo – maniglie per porte e filo muro	148, 164
finali per corrimano	810
finali per aste esterne.....	221
finiture – elenco ed illustrazioni	1014
finiture - tabella	1020
fissaggio - sistema con grano perforante	987
flat line	148
forni e stufe - maniglie e maniglioni per forni e stufe ..	859, 861
foro asse - bocchette con	765, 891, 892, 894
fresa – Utensile di foratura	160, 170
ganci	794
ganci privacy e ganci Roma	826
grani - viti di fermo.....	981, 983
guarnizioni	982
hotel - guarniture per.....	739
impugnatura maniglia con collo basso	196, 226
impugnatura maniglia lunga	338, 425, 426, 427
incasso - placche incasso	607
indice alfabetico per maniglie	4
info tecniche per nottolino WC.....	172
interassi - distanze	31
inox - acciaio	467
internet – www.antigerm.it.....	42
istruzioni di manutenzione	18, 21
Kaba – bocchette con foro Kaba	932
kit per porte scorrevoli	618
laser – logo a laser	28
lettere	814
limitatori di apertura - segretini	763
logo personalizzato	28
lucido naturale - finitura ottone	133
martellina - coppia per basculanti.....	858
martelline.....	32, 856
manettine per mobili.....	796
manettine tipo marina militare.....	799
maniglie - mezze + pomolo per porte blindate.....	da 775
maniglie da blocco.....	859
maniglie per porte e finestre	223
maniglie per porte finestre.....	207
maniglie per serramenti in ferro.....	858

INDICE TEMATICO

tipo di articolo.....	pag.
maniglioni fissi.....	500
maniglioni per alzanti scorrevoli	711
maniglioni per porte d'entrata	500
maniglioni per stufe e forni	861
manutenzione - istruzioni	18,21
materiali.....	18
mezze maniglie - per porte blindate.....	775
minimal line - maniglie con rosette Minimal Line.....	164
MK	215
molle varie.....	977
movimenti per cremonesi e DK	966
MP - movimento per aste esterne	219, 968
nero californiana - finitura ottone	137
nicchia 063 -info tecniche.....	713
nottolini WC	176
numeri	814
ordini - specifiche commerciali e tecniche.....	30
ordini - commissioni - come effettuare l'ordine di maniglie...30	
ottone antico collection	45
ottone lucido naturale collection	133
ottone nero californiana collection	135
ottone ruggine collection.....	91
ottone rustico collection.....	103
pannelli - espositori	1007
passanti per aste esterne	219
passante a rullo	817
pellicola protettiva	28
piastrina copriscasso per porte scorrevoli.....	709, 698
piastine di fissaggio per pomoli fissi.....	772, 976
piedini regolabili	817
pinze a scatto e fermaporte	835, 836
placca stretta	196
placche incasso e kit per porte scorrevoli	607
placche per cremonesi - martelline - DK - TK	955
placche per maniglie.....	944
placche per FINESTRE per ristrutturazioni	216
placche per PORTE per ristrutturazioni	193, 953, 956, 958
placche speciali per profili stetti	196
placche speciali per porte REL.....	197
pomoli per cilindro a codolo.....	764, 783
pomoli fissi e girevoli	555
pomolini per mobili.....	800
pomoli per porte d'entrata fissi/girevoli	556
porcellana.....	447
porte raso muro - maniglie per porte raso muro	148, 164
portabiti.....	790
portachiavi	863
portanome targhette.....	819
porte hotel.....	739
porte rei - info	197
porte scorrevoli - articoli per.....	607
porte vetro - articoli per	323, 483
profili stretti - placche e rosette per	196
prolunga per spioncino Q-SPY.....	825
protezione - pellicola a strip.....	28
protezione cilindro - bocchette di sicurezza - defender...758, 781	
protezione finestre - martelline - cremonesi - DK	200
pulsante campanello	818
pulsanti - DK con.....	200
pvd - caratteristiche.....	21
qualità- certificazioni	1, 8
ramato vintage collection.....	129
raso muro - maniglie per porte a raso muro	148, 164
ricambio - articoli da	989

tipo di articolo.....	pag.
riduzioni per bussole DK.....	210
riduzioni per ferri quadri.....	981
ristrutturazioni - per finestre	216
ristrutturazioni - per porte	193, 953, 956, 958
rosette	874
rondelle	982
ruggine - finitura ottone.....	91
rullini scorcinghia per avvolgibili.....	788
rustico - finitura ottone.....	103
salvaporta per porte scorrevoli	698
scatole - confezioni - packaging	1006
schemi di foratura per porte scorrevoli	612
Securblock -DK con pulsante anti-effrazione	200
segretini piccoli	495, 852
segretini limitatori di apertura.....	763
self sevice - confezioni	1006
serigrafia - logo a laser.....	28
serramenti in ferro - maniglie per cancelli e serramenti in ferro ...858	
serrature per porte a battente	964, 966
serrature per porte scorrevoli	618, 706
servizio SRG (sped. rapida garantita)	26
set lock	964
set viti.....	983
sicurezza - articoli per.....	757
simboli.....	patella, 872
sistema con grano perforante	987
Sistema MK	215
SMG (sistema montag. garantito)	26, 873
SMR (servizio montag. rapido)	27, 873
sommario.....	2
sostituzioni - maniglie per finestre	216
sostituzioni - maniglie per porte.....	193, 953, 956, 958
specifiche commerciali e tecniche	30
spioncino quadro Q-SPY	825
stock - pomolini per mobili	1000
stufe e forni - maniglie e maniglioni per.....	859, 861
supporti per corrimano e per mensole	806
system 2000	869
system Australia Ø52	870
system North America	871
system N08.....	869
system R38	868
system R1	868
system R16	866
system RPM.....	870
targhette portanome.....	819
tavellini e incontri	840
tronconi passanti	979
tubi per corrimano.....	813
UMI - Utensile Montaggio per porte scorrevoli	699
viti e bussole	978
visualizzatore di presenza.....	740
wc - nottolini.....	172, 176, 494
wc - soluzioni per porte bagno	172, 494
XL Line.....	338, 425, 426, 427
zama lucida verniciata	24

CONDIZIONI GENERALI DI VENDITA GENERAL TERMS AND SALES CONDITION

PREZZI

Le quotazioni indicate sul presente catalogo listino 2015 sono espresse in Euro e si intendono IVA esclusa.

La Reguitti Spa si riserva la facoltà di modificare prezzi, sconti e condizioni di vendita in qualunque momento senza alcun obbligo di preavviso.

Per quantitativi particolari o esigenze specifiche, vi invitiamo a richiedere offerte personalizzate, contattando direttamente il nostro Ufficio Vendite. Eventuali errori di stampa del listino non costituiscono motivo di contestazione.

ORDINI

La Reguitti Spa si riserva di accettare in tutto o in parte gli ordini che riceverà direttamente o tramite i propri rappresentanti.

I quantitativi ordinati devono essere tassativamente conformi alle confezioni indicate sul presente catalogo. Le quantità non conformi verranno automaticamente arrotondate al multiplo superiore della confezione prevista e non saranno accettati resi di merce dovuti a tali arrotondamenti, se accettate a seguito di esplicita richiesta, saranno soggette ad una maggiorazione del 15% sul prezzo di listino.

L'importo minimo spedibile è di Euro 250,00 (duecentocinquanta/00) al netto di iva.

In casi eccezionali potranno essere accettate spedizioni di importo inferiore che comporteranno inderogabilmente un supplemento fisso di Euro 15,00 (quindici/00), oltre al normale addebito del costo di trasporto.

CONTRATTI DI ESCLUSIVA:

Laddove indicati sul catalogo listino con la definizione "ESCLUSIVA", i prodotti possono essere commercializzati solo dopo la verifica esatta delle condizioni vigenti tra la Reguitti Spa e i titolari dell'esclusiva stessa (scadenza del contratto ed area di estensione dell'esclusiva).

CONSEGNE E SPEDIZIONI:

E' nostra cura effettuare le consegne con la massima celerità, tuttavia i termini di consegna non sono assolutamente da ritenersi vincolanti.

Per necessità di produzione o su richiesta del cliente potranno essere effettuate consegne parziali dell'ordine, con riserva da parte della Casa di annullare la rimanenza o aggiungerla all'ordine successivo.

Eventuali aggiunte agli ordini già in corso vengono accettate con riserva e possono ritardare il termine di consegna concordato.

Non vengono accettate richieste di risarcimento danni per ritardi di consegna.

La merce viaggia sempre ad esclusivo rischio e pericolo dell'acquirente, che ha l'obbligo di ritirarla. In caso di mancato ritiro, tutti i danni e le perdite inerenti e conseguenti saranno a carico dell'acquirente stesso.

Il destinatario, a propria cura e spese, si impegna a verificare i colli prima del ritiro e a rivolgere per iscritto eventuali reclami direttamente al vettore responsabile nel caso riscontri danni, ammanchi o altre difformità. Comunque si raccomanda di apporre sempre la nota "SI ACCETTA CON RISERVA DI CONTROLLO" sui documenti di consegna del vettore.

La merce si intende sempre resa franco nostra fabbrica.

A richiesta può essere resa franco destino con relativo addebito in fattura.

RECLAMI E SOSTITUZIONI:

Si accettano eventuali reclami unicamente se fatti pervenire entro 8 giorni dalla data del ricevimento della merce.

Eventuali resi di merce devono essere effettuati esclusivamente previa nostra autorizzazione e secondo le modalità che saranno concordate con il nostro responsabile al momento dell'autorizzazione al reso stesso.

Per eventuali articoli speciali, approntati appositamente su richiesta del cliente e, pertanto, fuori-standard, non saranno accettati resi per nessun motivo.

PAGAMENTI:

Dovranno essere effettuati presso la sede della Reguitti Spa, o presso la Banca indicata dalla stessa, entro e non oltre la scadenza concordata. Trascorso il termine stabilito, saranno conteggiati interessi di mora in misura del tasso passivo legale bancario vigente.

Il mancato pagamento, anche parziale, autorizza la Reguitti Spa a sospendere ulteriori invii di merce.

ARTICOLI:

I dati tecnici di questo catalogo sono soggetti a tolleranze normali per lo stato dell'arte del prodotto, le misure specificate sono in millimetri e puramente nominali (generalmente arrotondate all'unità).

Dati, foto, disegni e colori sono indicativi.

FORO COMPETENTE:

Per qualsiasi controversia è competente unico il Foro di Brescia.

La Reguitti Spa si riserva la facoltà di apportare in qualunque momento modifiche ai modelli illustrati nella presente pubblicazione, per ragioni interne o di natura tecnica o commerciale, senza doverne dare preavviso alla clientela.

PRICES

The quotation indicated on the present catalogue Price-list 2015 are expressed in Euro currency.

For high quantities or specific demands, please contact our Sales Department to require personalized offers.

ORDERS

Reguitti spa reserves to accept fully or partially all the orders received directly or through our salesmen or agents.

The quantity ordered must be strictly related to the packing indicated on this catalogue.

The quantities ordered will be automatically rounded up to the superior multiple of the foreseen packing.

We will not accept goods returned because of these rounding up.

EXCLUSIVE ITEMS

When you find in the catalogue the indication "EXCLUSIVE", it means that the items can be sold after checking the conditions of exclusive right existing between Reguitti spa and their customers. (expiry of agreement and area of exclusivity).

DELIVERY AND FORWARDING

Delivery terms agreed are not binding and are always to be considered approximate.

Where in power special attention will be paid to accelerate deliveries and complete packing.

Due to production reasons or customers requirements, partial deliveries can be made.

Reguitti Spa has the right to cancel the balance of goods not shipped or to add them to the next Customer's order.

Additions of goods to the order already in progress are accepted but they can delay the term of delivery agreed.

The goods always travel at the customer's own risk.

The customer is always obliged to accept the goods. On the contrary, all the damages and the costs due to that missed collection will be on his own charge.

The customer, at his expense and care, must check the goods on arrival; claims for damages or missing goods must be communicated in writing directly to the forwarder-agent.

However we strongly recommend to put always on the paperwork delivered by the forwarder that goods are accepted with reserve of control.

The goods are always ex-works our factory.

If required, we can send goods also free on destination, with freight charged on invoice.

CLAIMS AND REPLACEMENTS

Claims will only be accepted if received in writing within the peremptory term of 8 days from the date of receiving the goods.

If the customer wants to return goods and the claims are justified, he must contact us and to make agree with our sales manager about the way of returning the goods. Returned goods without our prior approval are not allowed.

If the goods are produced on Customer purpose we will not accept the return for any reason.

PAYMENT

All payments must be made at our registered head office in Agnosine, Località Fondi, or by swift bank transfer as we indicate on the invoice, within and not later than the date of expiry we fixed. After this term, we will debit interest for delay based on the legal interest rate.

In case of missing or partial payment, Reguitti spa is allowed to send no more goods.

ITEMS

For technical data indicated on this catalogue, tolerances are allowed and the measures we specify are millimetres and only nominal (generally rounded off unity). Dates, pictures, draws and colors are not binding.

COMPETENT LAW-COURT

For any dispute, the competence belongs to the law-court of Brescia (Italy) only.

Reguitti spa keeps the right to modify the features of any item for internal, technical or trade reasons, without providing any notice to the customer.

Reguitti S.p.A.

Località Fondi, Zona industriale 33

25071 Agnosine (BS)

P.iva: IT00573810983 - CF: 00632050175

Il presente listino annulla e sostituisce i precedenti
The present price-list cancels out and substitutes every previous ones





Finito di stampare nel mese di settembre 2015
Printed on september 2015

IL CATALOGO
THE CATALOGUE

15

REGUETTI[®]
Maniglie & Accessori

 Zona industriale località Fondi, 33
25071 Agnosine (Brescia)
ITALIA

 +39 0365 896186

 +39 0365 896137

 www.reguitti.it

 sales@reguitti.it



V000VCLCRE15***